

MODEL SX-42 OPERATING INSTRUCTIONS

MODEL SX-42

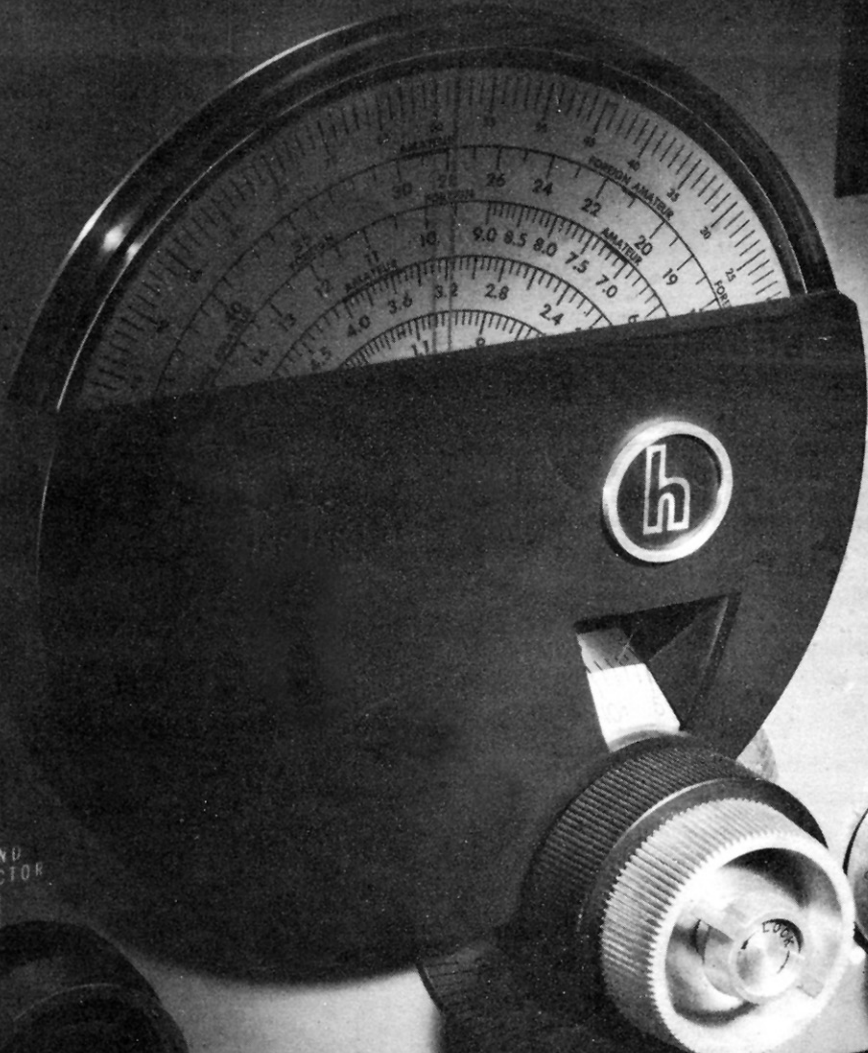

hallicrafters co. CHICAGO, ILL.

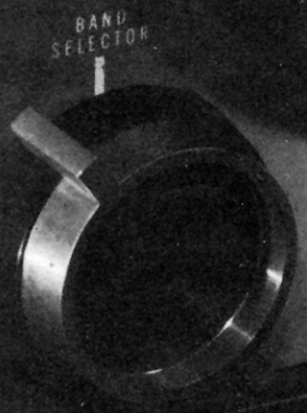

450
devoted est.
VOL. XXX No.

Warranty

The Hallicrafter's Company warrants each new radio product manufactured by it to be free from defective material and workmanship and agrees to remedy any such defect or to furnish a new part in exchange for any part of any unit of its manufacture which under normal installation, use and service discloses such defect, provided the unit is delivered by the owner to us or to our authorized radio dealer or wholesaler from whom purchased, intact, for our examination, with all transportation charges prepaid within ninety days from the date of sale to original purchaser and provided that such examination discloses in our judgment that it is thus defective.

This warranty does not extend to any of our radio products which have been subjected to misuse, neglect, accident, incorrect wiring not our own, improper installation, or to use in violation of instructions furnished by us, nor extend to units which have been repaired or altered outside of our factory, nor to cases where the serial number thereof has been removed, defaced or changed, nor to accessories used therewith not of our own manufacture.

Any part of a unit approved for remedy or exchange hereunder will be remedied or exchanged by the authorized radio dealer or wholesaler without charge to the owner.

This warranty is in lieu of all other warranties expressed or implied and no representative or person is authorized to assume for us any other liability in connection with the sale of our radio products.

F O R E W O R D

The Hallicrafters Company desires that you obtain from your SX-42 receiver the greatest possible degree of pleasure and satisfaction. Knowing that it is foremost in your mind to give your radio the proper attention, and to understand the methods of operating it to obtain outstanding radio reception, Hallicrafters have prepared this instruction book for your guidance and information.

These instructions are written in two parts: the first section in a non-technical language; the second section in technical language. In the first section, illustrations are used extensively and should be referred to while reading. You will find it beneficial to have your radio in front of you while you read this book. It will help you to become familiar with the adjustment of special control knobs and switches to obtain maximum performance. It is easy to get all wave world wide reception with your SX-42 receiver from the beginning if you follow these simple instructions. We believe you will enjoy reading this book, and will want to refer to it from time to time.

To the advanced radio amateur, you will find in the second section technical discussions of the circuits employed and discussions of new and important features specifically incorporated in the SX-42 to bring you, as always, the finest in radio.

Sincerely,

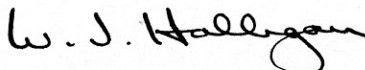

W. J. Halligan

the hallicrafters co.

TABLE OF CONTENTS

<u>Section</u>	<u>Subject</u>	<u>Page</u>
PART I	<u>GENERAL INFORMATION</u>	
1.	Installation	1
2.	General Operation	1
PART II	<u>DETAILED AND TECHNICAL OPERATING INSTRUCTIONS</u>	
1.	General	4
2.	A-C Operation	4
3.	D-C Operation	4
4.	Output Connections	4
5.	Phono Input Connection	5
6.	Antenna and Ground Connections	5
7.	Detailed Operations	5
8.	"S" Meter Adjustment	7
PART III	<u>SERVICE</u>	
1.	Replacing Tubes	8
2.	Replacing Dial Lamps	8
3.	Service or Operating Questions	8
	<u>REPLACEMENT PARTS LIST</u>	9

LIST OF ILLUSTRATIONS

<u>Figure</u>	<u>Subject</u>	<u>Page</u>
1	Model SX-42 Radio Receiver front view	iv
2	View showing Volume Control	1
3	View showing Band Selector Switch	1
4	View showing three toggle switches	1
5	View showing six right hand controls	2
6	View showing Bandsread and Main Tuning Dials	2
7	View showing carrier meter	2
8	View showing Tone Control	2
9	View showing Selectivity Control	2
10	Octal plug wiring diagram	4
11	Phono input diagram	5
12	Illustration showing Noise Limiter action	6
13	Illustration showing Single Signal Operation	6
14	Selectivity Curves	6
15	Crystal Curves	7
16	Tone Control Curves	7
17	Top view of Chassis	8
18	Remote Control Connections	12
19	Model SX-42 Schematic Wiring Diagram	13



Figure 1. Model SX-42 Radio Receiver front view

**INSTALLATION AND OPERATING INSTRUCTIONS FOR
RADIO RECEIVER MODEL SX-42**

**PART I
GENERAL INFORMATION**

I. INSTALLATION

It is recommended that, upon receipt, the carton and then the unpacked receiver be carefully examined for any damage which may have occurred during shipment. Should any damage be apparent, immediately file claim with the carrier, stating the extent of damage.

IMPORTANT. Unless otherwise marked, this receiver is operated from 105 to 125 volts 50-60 cycle a-c power. If in doubt call your local utility company for information.

After the receiver is unpacked from the carton, it should be placed on a convenient operating table or on one of the Hallicrafters floor model reproducers R-75 or R-80. If used on a table or desk the R-42 Reproducer is recommended.

Connect the R-42 Reproducer, or the R-75 or R-80, as the case may be, to the 500 and "C" terminals on the SX-42.

Turn the VOLUME control to the left as far as possible. (See Fig. 2.) This turns off the radio. Plug the power cord into the a-c outlet.

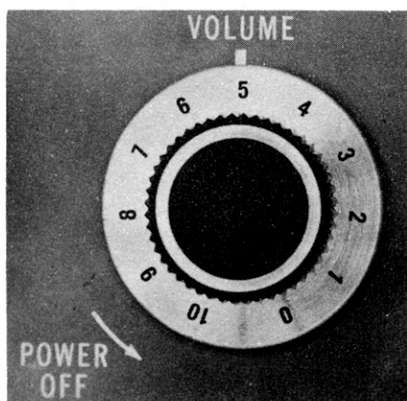

Figure 2. View showing Volume Control

Attach an antenna (aerial) to the post marked A-1. This antenna wire should be, preferably, outdoors above surrounding structures and from 25 to 100 feet long. Attach a wire from a good ground to the post marked GND. In general the better the antenna system, the better the signal will be heard.

Having followed instructions to this point you are now ready to operate your receiver. Let's first tune in a-m (standard broadcast) stations.

2. GENERAL OPERATION

1. To turn the receiver on, the VOLUME control is turned to the right to about 3 on the knob scale. When the receiver is on, the dial scales and the meter will light up. If the dials do not light up, a-c power is not being supplied to the receiver. Test the socket used with a floor lamp or an electrical appliance as it may be defective.

2. Turn the BAND SELECTOR knob left to the red dot. (See Fig. 3.)

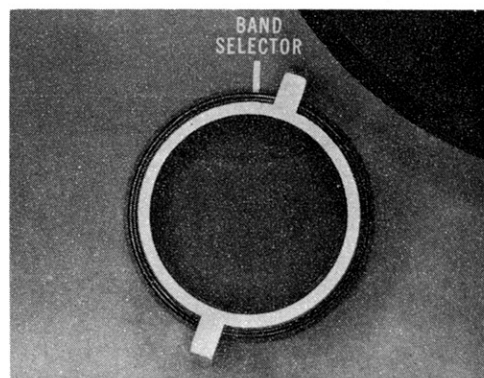

Figure 3. View showing Band Selector Switch

3. Set the three toggle switches in the up position. (See Fig. 4.)

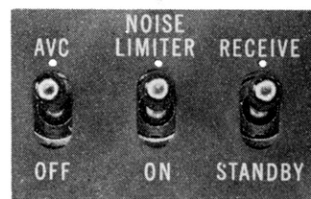

Figure 4. View showing three toggle switches

4. Set the six right hand control knobs to the red dot setting. (See Fig. 5.)

5. Set the bandspread (fine tuning) dial to 0 (See Fig. 6) by turning the outer or metal knob on the tuning assembly. If the bandspread dial doesn't move, operate the locking knob (See Fig. 6) by turning to the right to unlock the bandspread dial. After setting the bandspread dial to zero, again turn the locking knob to the right to lock the bandspread.

6. Now tune in stations by tuning with the main control knob. (See Fig. 6.) As the station is tuned in, the carrier meter needle (See Fig. 7) will move from the left side of the scale to the

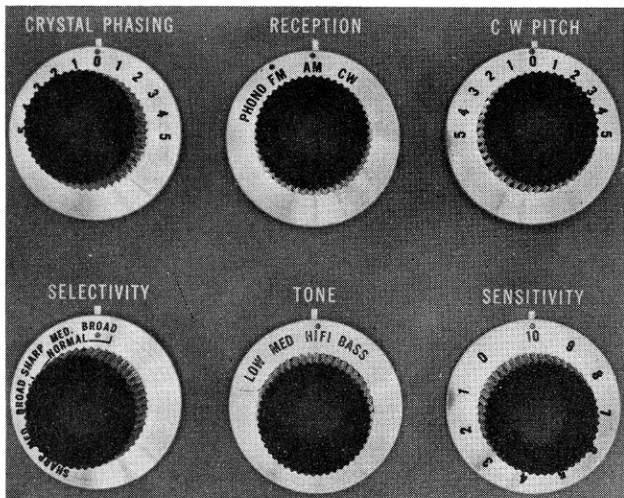

Figure 5. View showing six right hand controls

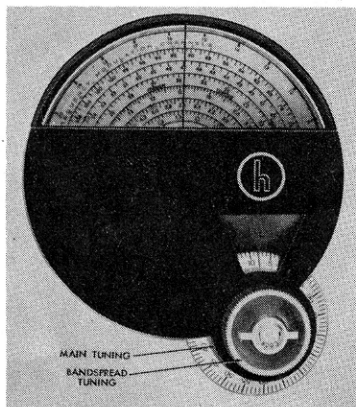
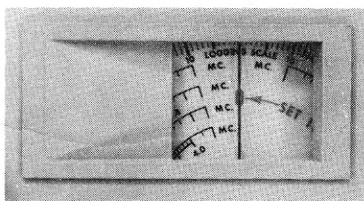

Figure 6. View showing Bandsread and Main Tuning Dials

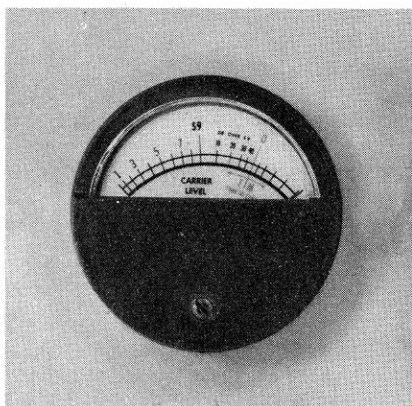

Figure 7. View showing Carrier Meter

right. Carefully tune the receiver by causing the meter needle to move as far to the right as possible. At this point the receiver is properly tuned to the station.

7. To control the volume, adjust the VOLUME control (See Fig. 2.) by turning it to the right for a louder signal or to the left for a softer signal.

8. The frequency calibration on the main tuning dial for the broadcast band is shown on the scale at the bottom of the dial. (See Fig. 6.) This scale as all other scales is calibrated in mc (megacycles) and tunes over the broadcast band from .54 to 1.62 mc (in kilocycles 540 to 1620 kc). For example, radio station WGN Chicago is 720 kc or .72 mc. Just divide kc by 1000 to get mc.

9. The next control which will be of interest to you, will be the TONE control. (See Fig. 8.) When it is set on the red dot, the receiver produces substantially all musical tones as sent out by the radio station. However, by setting this control to BASS, HI-FI, MED, or LOW, you can adjust the tone as you prefer.

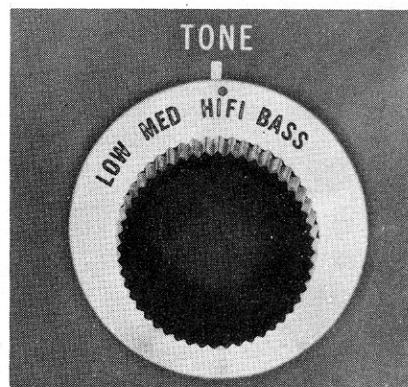

Figure 8. View showing Tone Control

10. The next control in sequence of importance is the SELECTIVITY control (See Fig. 9.). This control is very useful when it is desired to tune in a weak station on a frequency close to a powerful one, in which instance the control should be switched to MED, or in extreme cases to SHARP.

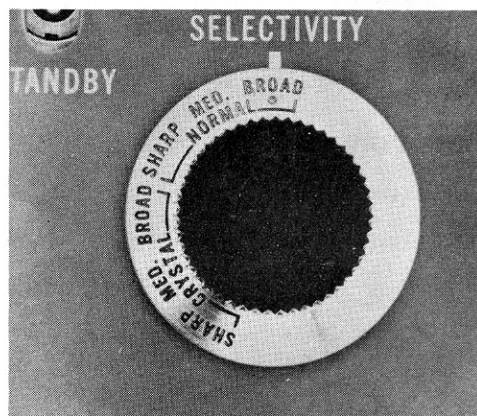

Figure 9. View showing Selectivity Control

11. The knobs for CRYSTAL PHASING, RECEPTION, CW PITCH, and SENSITIVITY should in all cases be left set at the red dot.

Thus far we have tuned the receiver for a-m reception. If it is desired to use it on f-m reception, all controls should be set as previously described with the exception of the following:

1. The RECEPTION knob should be switched to FM (green dot).
2. The BAND SELECTOR switch should be set on the green dot. This covers the band 55 to 108 mc. Most f-m stations are on this band; the few that are not can be tuned in by changing the BAND SELECTOR knob to 28 to 55 mc.
3. For a normal f-m station the position of the toggle switch marked AVC may be left in the up position; if it is a weak station, the switch should be in the down position.
4. Tune in f-m stations by turning the larger

of the tuning knobs until the main tuning dial indicates the desired f-m frequency. As the station is being tuned, the meter pointer will deflect first to one side of zero (red line marked "FM tune to 0"), return to zero, and deflect to opposite side of zero. When meter pointer returns to zero the first time, the station is tuned in.

5. The Carrier Level Meter reads the relative signal strength of received signals as well as indicating when an AM signal is properly tuned in by the maximum deflection of the meter needle. When using the carrier level meter, the AVC toggle switch must be in the "up" position (AVC OFF) and the SENSITIVITY CONTROL must be turned to the Red Dot setting. Volume is then controlled by the MANUAL VOLUME control.

So far we have covered three bands of the receiver (Broadcast, and the f-m bands 55-108 mc and 28-55 mc). For the other three bands of the set, operation is the same, the only difference being in the setting of the BAND SELECTOR switch knob, which may be turned to the desired band.

PART II

DETAILED AND TECHNICAL OPERATING INSTRUCTIONS

1. GENERAL

The Model SX-42 is a 15 tube superheterodyne radio receiver designed to provide amplitude modulated (a-m) reception over the frequency range 540 kc (kilocycles) to 110 mc (megacycles) and high fidelity, frequency modulated (f-m) reception over the frequency range 27 to 110 mc. Calibrated bandspread is provided for the 80, 40, 20, 10, and 6 meter amateur bands. The general coverage dial and bandspread dial are operated from one tuning control which consists of two independent knobs turning on concentric shafts. A dial lock is provided to lock the unused dial while tuning the receiver. This exclusive Hallicrafters feature insures accurate tuning and logging.

FREQUENCY COVERAGE

BAND	COVERAGE	TYPE OF RECEPTION
1	540 to 1620 kilocycles	AM/CW
2	1.62 to 5 megacycles	AM/CW
3	5 to 15 megacycles	AM/CW
4	15 to 30 megacycles	AM/CW
5	27 to 55 megacycles	AM/FM/CW
6	55 to 110 megacycles	AM/FM/CW

Adequate overlap is provided at ends of all bands.

The receiver as normally supplied is designed to operate from a 105 to 125 volts 50/60 cycle, single phase source of a-c power. These operating instructions also cover Universal Models which operate from a 105 to 250 volts, 25/60 cycle single phase a-c source.

2. A-C OPERATION

Be sure line voltage is 105 to 125 volts and frequency is 50 to 60 cycles before inserting power cord plug into power outlet. Be sure all tubes are securely inserted in their proper sockets before receiver power is turned on. The chart below lists the current and voltage data.

Power Consumption	110 Watts
Frequency	50/60 Cycles
Line Voltage.	117 Volts
Line Current.	0.93 Amperes

During a-c operation, the shorting plug supplied with the receiver must be in the octal socket on the rear apron of the chassis.

3. D-C OPERATION

The receiver may be operated from a 6 volt d-c source, generally a storage battery, and a 270 volt d-c supply in the form of "B" batteries or vibrator type power pack. Consult the chart on power requirements at the end of this paragraph and provide battery or power pack facilities capable of supplying these demands. The receiver is connected to the d-c supply as follows:

1. Remove the octal shorting plug for a-c operation from the socket SO-1 located on the rear apron of the receiver chassis.

2. Wire an octal plug, as shown in Fig. 10, and plug it into socket SO-1. Use #19 (AWG) wire leads for the 270 volt "B" supply connections to pins #3 and #5, and #12 (AWG) wire leads for the 6 volt battery connections to pins #1, #7, and #8. **CAUTION:** Check the wiring carefully before connecting to the battery supply. The chart below lists the current voltage data.

"B" Voltage	270 Volts
"B" Current	150 ma.
Filament Voltage.	6 Volts
Filament Current.	5 Amperes

Total battery drain when operating from a 6-volt vibrator power supply is approximately 16 amperes.

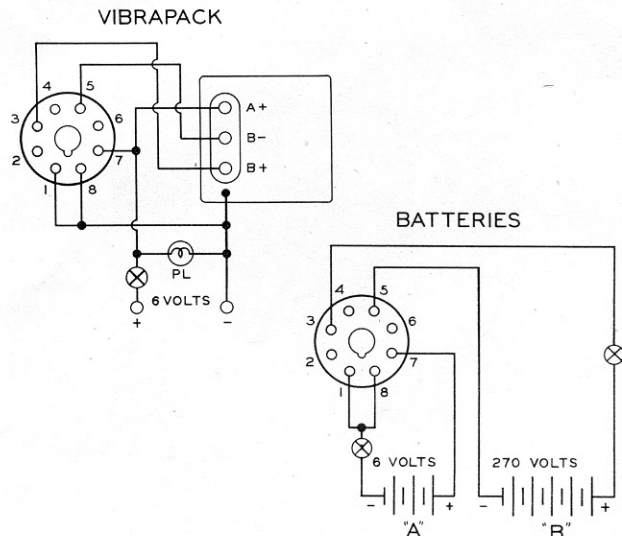

Figure 10. Octal plug wiring diagram

4. OUTPUT CONNECTIONS

Output connections for the speaker are provided for on the rear apron of the chassis. Two output impedances are available. Either the 500/600 or the 5000 ohm speaker connection may be used according to the output impedance desired. This arrangement of dual output impedances will accommodate most requirements. The Hallicrafters Model PM-23 speaker requires 5000 ohms impedance; the Hallicrafters Model R-42, R-44, R-75, or R-80 requires 500/600 ohms. However, any standard type, permanent magnet dynamic speaker with output transformer may be connected to the output terminals. If the permanent magnet dynamic speaker impedance is unknown, try the 5000 ohm and then the 500/600 ohm impedance, and use the one which gives the better tone quality and volume.

5. PHONO INPUT CONNECTION

A receptacle is provided on the rear apron of the chassis for connecting a phonograph record player to the receiver. This receptacle is designed to accommodate a Cinch, type M-93, pin connector plug. (See Fig. 11. for diagram)

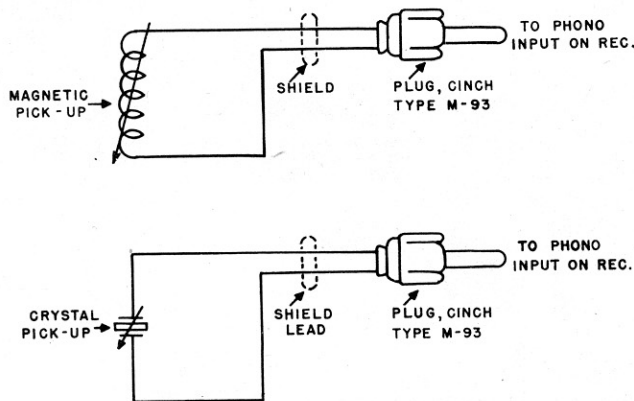

Figure 11. Phono input diagram

6. ANTENNA AND GROUND CONNECTIONS

The Model SX-42 is designed for a 300 ohm antenna impedance. The antenna impedance is not critical and excellent reception can be obtained from an antenna of from 50 to 600 ohm impedance. For maximum performance, the best possible antenna should be employed.

The antenna terminals on the Model SX-42 are arranged for any type of antenna from those requiring a ground to those using a transmission line. The transmission type of antenna connects to the A-1 and A-2 terminals whereas a single wire antenna utilizes terminal A-1 for the antenna lead. A-2 and GND terminals must be connected together and connected to a good ground.

7. DETAILED OPERATIONS

a. *Controls and Their Functions.* In order to obtain the desired results from the receiver, it is recommended that you become familiar with the function of each control. Red indicators on the controls for broadcast reception and green for f-m reception are there to simplify operation. Controls and their functions are as follows:

(1) BAND SELECTOR. The BAND SELECTOR knob operates the bandswitch to select the desired band of frequencies. The frequency range covered by each band is read directly on the BAND SELECTOR knob.

(2) General Coverage Tuning and Bandsread Tuning Control. The larger of the two concentric knobs tunes the receiver to the desired frequency. The smaller knob provides bandsread action or fine tuning as indicated on the bandsread scale. The winged knob in the center alternately locks the general coverage and the bandsread dials so that one

remains fixed while the other one is being tuned. The knob should be rotated in a clockwise direction only, locking first one dial and then the other as it is turned through one complete revolution. Note that the locked dial knob is free to turn, but that the dial itself is locked in position.

(a) General Coverage Dial. The general coverage dial has six calibrated scales and a logging scale. All six scales are calibrated in mc. The calibrated metal skirt of the general coverage dial knob acts as the vernier calibration for the logging scale. The outer logging scale (on the general coverage dial) is divided into 21 divisions, each division representing one revolution of the vernier dial which also carries a logging scale divided into 100 divisions, thus providing 2100 divisions for logging use. The dial settings for the various amateur bands are indicated on the main tuning dial by black dots and the abbreviations 80M, 40M, etc. directly below the dot. When tuning the amateur bands with the calibrated bandsread dial, the general coverage dial must be set and locked at the setting corresponding to the amateur band desired.

For a reference when tuning in foreign broadcast stations, the word FOREIGN has been placed at the appropriate positions along the dial scales. The f-m channel 88 to 108 mc has been divided into 100 divisions by the scale above it marked 0, 10, 20, 30, etc. in green numbers which correspond with the frequency modulated channel assignments. Since the general coverage and bandsread tuning systems are electrically related, it is necessary to set the bandsread dial at "0" when tuning the receiver with the general coverage dial control to obtain correct receiver frequency readings on the general coverage dial.

(b) Bandsread Dial. The bandsread dial has five scales calibrated for the amateur bands and a 100 division logging scale. The five scales are calibrated to read receiver frequency directly in mc when the general coverage dial has been set to the corresponding indexing dot and locked in position.

(3) AVC-OFF Switch. This switch when set at AVC, provides a relatively constant volume level at the speaker for reasonable variations in signal strength at the antenna by automatically controlling the sensitivity of the receiver. Best results are obtained when the SENSITIVITY control is set at maximum sensitivity. The AVC switch must be set at OFF for c-w code reception.

(4) NOISE-LIMITER-ON Switch. This switch opens or closes the noise limiter circuit and is to be set at ON when the operator

wishes to limit excessive noise resulting from automobile ignition and other forms of noise interference.

The noise limiter circuit "clips" the intermittent noise peaks down to the level of the desired signal where they tend to become unnoticeable. (See Fig. 12 for illustration on noise limiter action.)

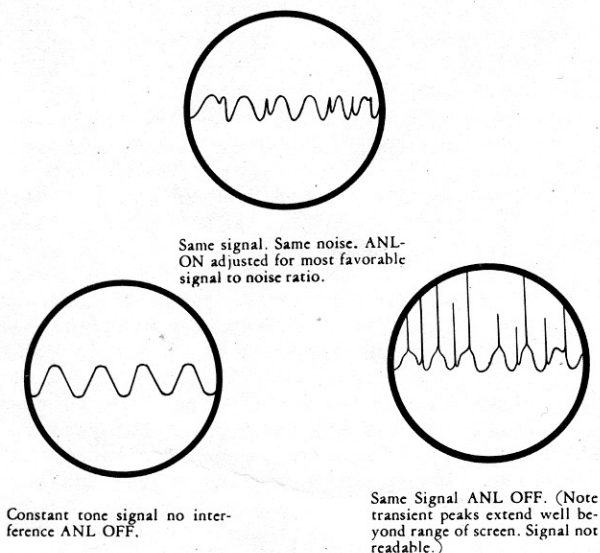

Figure 12.

Illustration showing Noise Limiter action

(5) RECEIVER-STANDBY Switch. When set at STANDBY, this switch renders the receiver inoperative, while transmitting or for any other purpose, although the tube heaters remain hot and ready for instant use.

(6) CRYSTAL PHASING Control. This control permits the discrimination of code signals whose frequencies are very nearly the same. The SELECTIVITY control must be set at one of its three crystal selectivity positions when using the phasing control.

It is extremely simple to attain single signal c-w reception with the SX-42. First, set the RECEPTION switch at CW and the SELECTIVITY control at CRYSTAL SHARP. Pick a good solid c-w signal, preferably a commercial station because a commercial is likely to stay on long enough for you to complete the phasing adjustment for single signal reception.

You will find on tuning across this signal that it has two amplitudes. Tune first to the weaker of these two amplitudes. Now, turn the CRYSTAL PHASING control until the weaker of the two amplitudes is reduced to a minimum. Then, tune to the stronger of the two amplitudes and adjust the PITCH control to a tone most pleasing to you. This adjustment for single signal selectivity will hold with no further adjustment unless you change the phasing control. (See Fig. 13 for an illustration of single signal operation.)

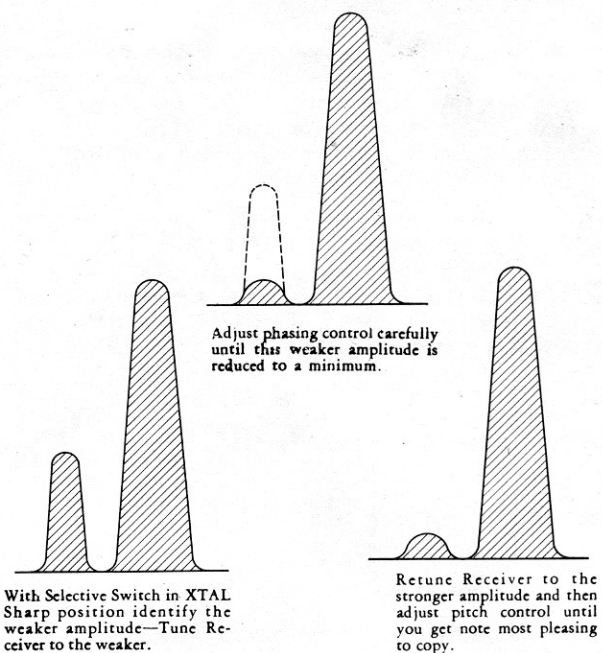

Figure 13.

Illustration showing Single Signal Operation

(7) SELECTIVITY Control. This control determines the sharpness of the response. Six degrees of selectivity are provided, ranging from CRYSTAL SHARP for c-w code reception under difficult receiving conditions to NORMAL BROAD response for high fidelity reception. (See Fig. 14 for i-f selectivity curves.)

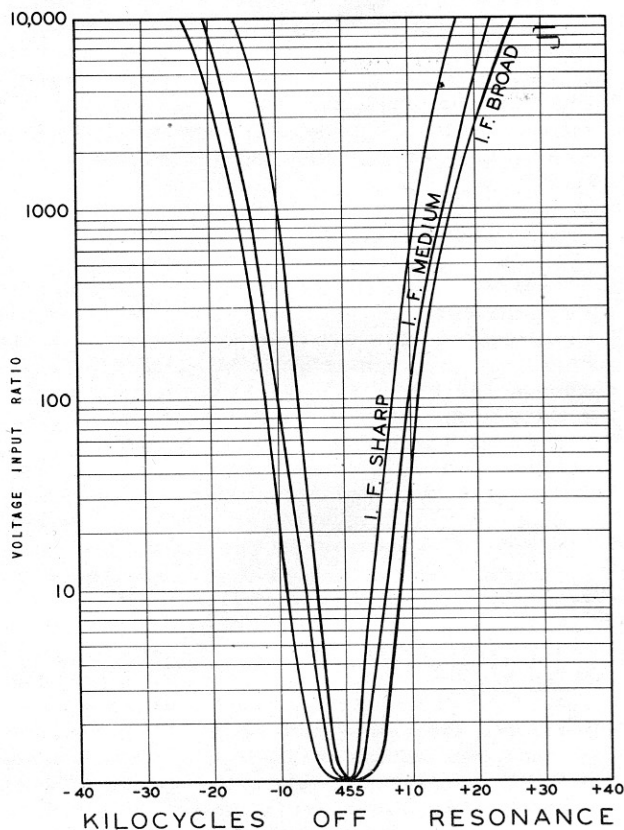

Figure 14. Selectivity Curves

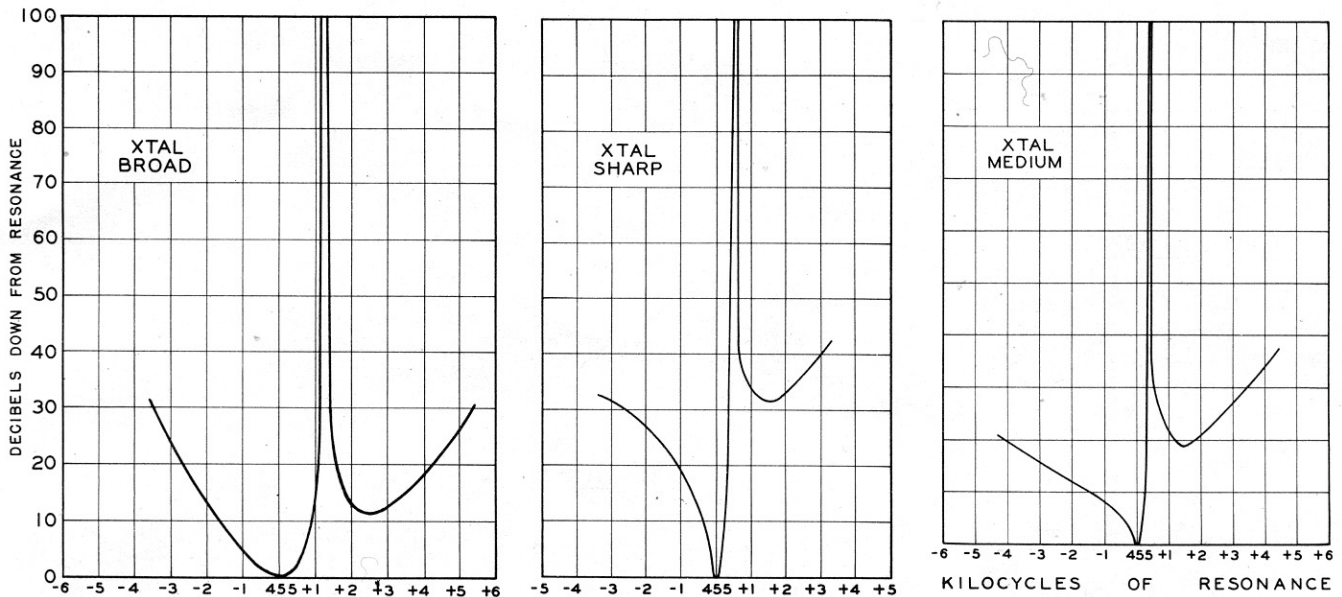

Figure 15. Crystal Curves

1. BROAD I-F (for high fidelity reception)
 2. MEDIUM I-F (more selectivity, less highs)
 3. SHARP I-F (reduces adjacent channel interferences and gives less highs)
 4. CRYSTAL BROAD (similar to sharp i-f but sharper cutting on sidebands)
 5. CRYSTAL MEDIUM (greatly increased sideband cutting very little highs present)
 6. CRYSTAL SHARP (position of extreme selectivity - practically no sideband content)
- (See Fig. 15 for crystal filter selectivity curves.)

(8) TONE Control. This control selects the tone qualities desired by the operator. The four types of response available are LOW, MED, HI FI, and BASS.

(a) LOW. The bass and high audio frequencies are attenuated to provide a minimum response for voice reception when the background noise level is objectionably high.

(b) MED. The bass and high frequencies are attenuated somewhat less than for the LOW position providing a response for more than the ordinary voice frequencies. This position is preferred for voice communication when the signal to noise ratio will permit.

(c) HI FI (High Fidelity). The bass and high frequencies are passed at the same level as the mid-frequency range thereby providing as near a true reproduction of the original signal as possible. The response is approximately uniform between 50 and 15,000 cycles per second for high fidelity reception.

(d) BASS. The response in the high frequency end of the audio range remains uniform as for the HI FI position; however, the level of the lower frequencies is boosted above the level of the medium and high frequency ranges.

Fig. 16 shows the typical audio frequency response curves for the four positions of the TONE switch.

(9) CW PITCH Control. This control varies the frequency of the beat frequency oscillator thus varying the pitch of the c-w code signal as desired.

(10) SENSITIVITY Control. This control adjusts the sensitivity by varying the resistance in the cathodes of the r-f and i-f amplifiers. Turning the control to the right increases the sensitivity. This control must be set at maximum sensitivity when using the carrier level meter. At any other setting of this control, readings of the carrier meter are meaningless.

8. "S" METER ADJUSTMENT

Adjustment of the "S" meter control is performed by varying the knurled knob located on the rear apron of the receiver chassis. This control enables you to properly set the "S" meter to zero. In order to make the adjustment correctly, advance the SENSITIVITY control to 10 (red dot). Set the AVC switch at ON position. Short the two antenna terminals to the ground terminal and tune receiver off station. Then adjust the "S" meter control until the pointer rests on left hand zero. Remove the short from the antenna terminals and the meter will indicate the relative carrier strength of each incoming signal as various signals are tuned in.

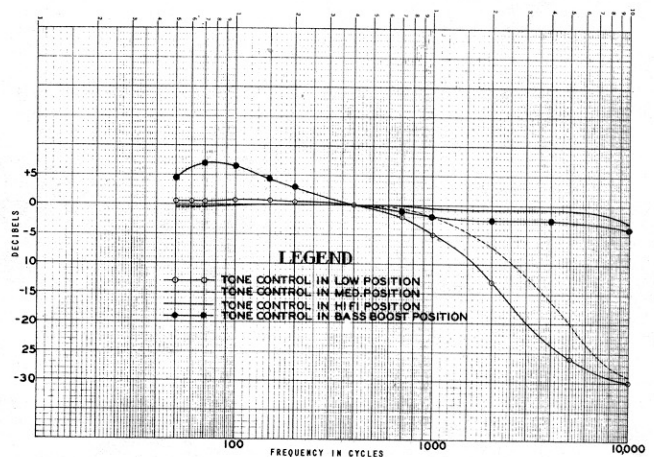

Figure 16. Tone Control Curves

PART III

SERVICE

1. REPLACING TUBES

All tubes are accessible at the top of the chassis through the hinged cover of the cabinet. When replacing tubes, check tube type carefully and replace with the correct type. Refer to top view of the chassis to determine the location of the tubes (See Fig. 17.)

2. REPLACING DIAL LAMPS

The receiver employs four dial lamps with the bayonet type sockets to illuminate the main

and bandsread tuning dials as well as the meter scale. The lamps are to be replaced with 6-8 volt, 250 ma, (blue bead) #44 G.E. type, or equivalent. The color code referred to is the color of the glass bead above the glass stem inside the envelope of the lamps.

3. SERVICE OR OPERATING QUESTIONS

If you should have any questions regarding the service or operation of your receiver do not hesitate to contact the dealer from whom the set was purchased.

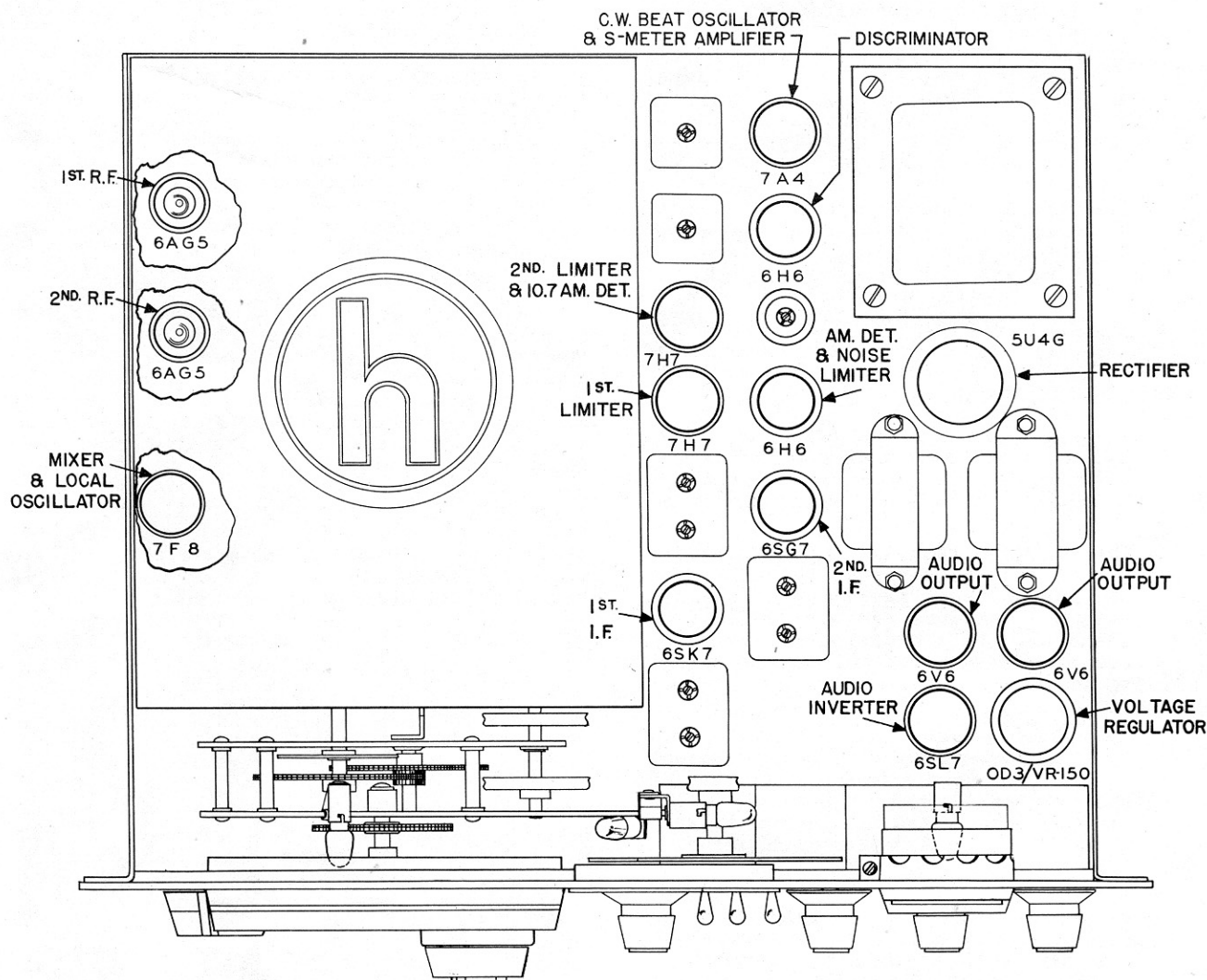

Figure 17. Top view of Chassis

REPLACEMENT PARTS LIST FOR MODEL SX-42 RADIO RECEIVER

REF. NO.	DESCRIPTION	HALLICRAFTERS PART NUMBER
<u>CAPACITORS</u>		
C-1, 2, 16, 17, 30, 31	Trimmer, Dual Mounting Assembly	44B165
C-3, 4, 6, 18, 19, 20, 21, 32, 33, 34, 35	R-F Trimmer (2-6 mmf) Ceramic	44B179
C-5	Capacitor (2 mmf 10%) Molded Bakelite	49A002
C-7	Capacitor (5 mmf ± .5 mmf .00075 T.C.) Ceramic	CC20UK050D
C-8, 11, 23, 25	Capacitor (.05 mfd 150V) Paper	46A094
C-9	Capacitor, Main Tuning	48C158
C-10	Capacitor, Bandsread	48C159
C-12, 26	Capacitor (.01 mfd ±40-15% 400V) Paper	46AB103J
C-13, 15, 27, 29, 50, 59, 63 74, 86, 87, 91, 100, 104, 109, 112	Capacitor (.02 mfd +4C-15% 400V) Paper	46AW203J
C-14, 28	Capacitor (5600 mmf 20% 500V) Mica	CM35A562M
C-22, 36	Capacitor (15 mmf 10% .00075 T.C.) Ceramic	CC20UK150K
C-24	Capacitor (.25 mfd ±40-15% 200V) Paper	46AT254J
C-37, 97	Capacitor (47 mmf 10% 500V) Mica	CM20A470K
C-38	Capacitor (.01 mfd 150V) Paper	46A095
C-39, 49, 127	Capacitor (110 mmf 5% .00075 T.C.) Ceramic	CC25UK111J
C-40, 41	Trimmer (4-20 mmf) Ceramic	44A078
C-42, 119	Trimmer (6-8 mmf) Mica	44A205
C-43, 45	Trimmer (2-6 mmf) Ceramic	44A077
C-44	Capacitor (4700 mmf 2% 500V) Mica	CM35C472G
C-46	Capacitor (1500 mmf 2% 500V) Mica	CM30C152G
C-47	Trimmer (4-20 mmf) Ceramic	44A076
C-48	Capacitor (470 mmf 2% 500V) Mica	CM20A471G
C-51	Capacitor (220 mmf 2% 500V) Mica	CM25E221G
C-52, 66, 71, 99, 108, 118, 126	Capacitor (.05 mfd +40-15% 400V) Paper	46AW503J
C-57, 105	Capacitor, Variable (CW Pitch & Crystal Phasing)	48A064
C-58, 60, 61	Trimmer Assembly (Triple)	44B164
C-62, 70, 85	Capacitor (.05 mfd +40-15% 200V) Paper	46AU503J
C-75, 79, 81, 92, 106, 121, 122	Capacitor (.01 mfd +40-15% 400V) Paper	46AW103J
C-78	Capacitor (22 mmf 10% 500V) Mica	CM20A220K
C-80, 120, 124, 125	Capacitor (7 mmf 10% .00075) Ceramic	CC20UK070K
C-82, 83, 89, 90	Capacitor (180 mmf 10% 500V) Mica	CM20A181K
C-84	Capacitor (.1 mfd +40-15% 200V) Paper	46AU104J
C-98	Capacitor (560 mmf 10% 500V) Mica	CM25A561K
C-107	Capacitor (10 mfd +75-10% 25V) Elect.	45A064
C-110	Capacitor (680 mmf 10% 500V) Mica	CM25A681K
C-111, 113, 116	Capacitor, Elect.	45A041
C-114, 115, 117	Capacitor (.01 mfd +40-15% vdcw) Paper	46AG103J
C-123	Capacitor (22 mmf 10%) Ceramic	CC20UK220K
<u>RESISTORS</u>		
R-1, 10, 51	Resistor (100,000 ohm 20% 1/2 watt) Carbon	RC20AE104M
R-2	Resistor (12 ohm 10% 1/2 watt) Carbon	RC20AE120K
R-3, 15	Resistor (150 ohm 10% 1/2 watt) Carbon	RC20AE151K
R-4	Resistor (47,000 ohm 10% 1 watt) Carbon	RC30AE473K
R-5, 9, 14, 19, 90	Resistor (15 ohm 20% 1/2 watt) Carbon	RC20AE150M
R-6, 13, 17, 20	Resistor (2200 ohm 20% 1/2 watt) Carbon	RC20AE222M
R-7, 18, 40, 67, 74, 78	Resistor (1200 ohm 10% 1/2 watt) Carbon	RC20AE122K
R-12	Sensitivity Control	25A548
P-16, 22, 32, 70, 86	Resistor (1000 ohm 20% 1/2 watt) Carbon	RC20AE102M
R-21, 48, 58	Resistor (2.2 megohm 20% 1/2 watt) Carbon	RC20AE225M
R-23	Resistor (47 ohm 20% 1/2 watt) Carbon	RC20AE470M
R-25, 56, 75, 69	Resistor (10,000 ohm 10% 1/2 watt) Carbon	RC20AE103K
R-26	Resistor (5600 ohm 10% 1/2 watt) Carbon	RC20AW562K
R-27	Resistor (470 ohm 20% 1/2 watt) Carbon	RC20AE471M
R-28	Resistor (68,000 ohm 10% 1 watt) Carbon	RC30AE683K
R-29	Resistor (120 ohm 10% 1/2 watt) Carbon	RC20AE121K

REPLACEMENT PARTS LIST FOR MODEL SX-42 RADIO RECEIVER

REF. NO.	DESCRIPTION	HALLICRAFTERS PART NUMBER
	<u>RESISTORS - Continued</u>	
R-30, 41, 42, 64, 88	Resistor (1 megohm 20% 1/2 watt) Carbon	RC20AE105M
R-31	Resistor (220 ohm 10% 1/2 watt) Carbon	RC20AE221K
R-34	Variable resistor (500 ohm) "S" type	25C022
R-36	Resistor (1.2 megohm 10% 1/2 watt) Carbon	RC20AE125K
R-37	Resistor (27 ohm 10% 1/2 watt) Carbon	RC20AE270K
R-38	Resistor (270 ohm 10% 1/2 watt) Carbon	RC20AE271K
R-39, 59, 87	Resistor (56,000 ohm 10% 1/2 watt) Carbon	RC20AE563K
R-43	Resistor (22,000 ohm 10% 1/2 watt) Carbon	RC20AE223K
R-44	Resistor (2 megohm 20% 1/2 watt) Carbon	RC20AE205M
R-45, 95	Resistor (330 ohm 20% 1 watt) Carbon	RC30AE331M
R-46, 57, 71, 94	Resistor (47,000 ohm 10% 1/2 watt) Carbon	RC20AE473K
R-49	Resistor (330,000 ohm 10% 1/2 watt) Carbon	RC20AE334K
R-50, 97	Resistor (33 ohm 10% 1/2 watt) Carbon	RC20AE330K
R-52, 53, 66	Resistor (470,000 ohm 20% 1/2 watt) Carbon	RC20AE474M
R-54	Resistor (100,000 ohm 10% 1 watt) Carbon	RC30AE104K
R-55	Resistor (33,000 ohm 10% 1/2 watt) Carbon	RC20AE333K
R-60	Resistor (330 ohm 10% 1/2 watt) Carbon	RC20AE331K
R-65	Resistor (150,000 ohm 10% 1/2 watt) Carbon	RC20AE154K
R-68, 91, 93	Resistor (4700 ohm 10% 1/2 watt) Carbon	RC20AE472K
R-72	Resistor (100 ohm 10% 1/2 watt) Carbon	RC20AE101K
R-73	Volume Control; includes power switch SW-8	25A549
R-76, 24, 92	Resistor (56 ohm 10% 1/2 watt) Carbon	RC20AE560K
R-77	Resistor (1000 ohm 10% 2 watt) Carbon	RC40AE102K
R-79, 80, 81, 83	Resistor (220,000 ohm 10% 1/2 watt) Carbon	RC20AE224K
R-82	Resistor (8200 ohm 10% 1/2 watt) Carbon	RC20AE822K
R-84	Resistor (220 ohm 10% 2 watt) Carbon	RC40AE221K
R-85	Resistor (2000 ohm 5% 10 watt) Wirewound	24BG202D
R-89	Resistor (68,000 ohm 10% 1/2 watt) Carbon	RC20AE683K
R-96	Resistor (680 ohm 20% 1/2 watt) Carbon	RC20AE681M
	<u>PILOT LAMP</u>	
LM-1, 2, 3	6-8 volt; 250 ma; bayonet type	39A018
LM-4	6-8 volt; 150 ma; bayonet type	39A019
	<u>PLUG</u>	
PL-1	Shorting Plug; octal	35A015
	<u>SWITCHES</u>	
SW-1	BAND SELECTOR	60D241
SW-2	SELECTIVITY	60A234
SW-3	RECEPTION	60C235
SW-4	TONE	60C236
SW-5, 6, 7	AVC, NOISE LIMITER, RECEIVER-STANDBY toggle; with bat handle; SPST	60A138
SW-8	POWER-OFF; not a replaceable part; shown for reference only; part of VOLUME control R-73.	
	<u>TRANSFORMERS</u>	
T-1	Antenna Coil; Band #6	51B829
T-2	Antenna Coil; Band #5	51B828
T-3	Antenna Coil; Band #4	51B827
T-4	Antenna Coil; Band #3	51B826
T-5	Antenna Coil; Band #1	51B823
T-6	R-F Coil; Band #6	51B833
T-7	R-F Coil; Band #5	51B832
T-8	R-F Coil; Band #4	51B831
T-9	R-F Coil; Band #3	51B830
T-10	R-F Coil; Band #2	51B825
T-11	R-F Coil; Band #1	51B824

REPLACEMENT PARTS LIST FOR MODEL SX-42 RECEIVER

REF. NO.	DESCRIPTION	HALLICRAFTERS PART NUMBER
	<u>TRANSFORMERS - Continued</u>	
T-12	Converter Coil; Band #6	51B845
T-13	Converter Coil; Band #5	51B844
T-14	Converter Coil; Band #4	51B843
T-15	Converter Coil; Band #3	51B842
T-16	Converter Coil; Band #2	51B841
T-17	Converter Coil; Band #1	51B840
T-18	Oscillator Coil; Band #6	51B839
T-19	Oscillator Coil; Band #5	51B838
T-20	Oscillator Coil; Band #4	51B837
T-21	Oscillator Coil; Band #3	51B836
T-22	Oscillator Coil; Band #2	51B835
T-23	Oscillator Coil; Band #1	51B834
T-24	1st I-F Transformer	50C198
T-25	2nd I-F Transformer	50C190
T-26	3rd I-F Transformer	50C197
T-27	Discriminator Transformer	50C191
T-28	BFO Transformer	54C032
T-29	Audio Output Transformer	55E077
T-30	Power Transformer	52C141
	<u>CHOKES AND COILS</u>	
L-1	R-f choke; oscillator	53B008
L-2	I-f coupling coil	53B104
L-3	Filter choke	56B067
L-4	R-f choke; filament	53E009
	<u>TERMINAL STRIPS</u>	
TS-1	Antenna-ground connections	88A567
TS-2	Same as TS-1; speaker connections	
	<u>METER</u>	
M-1	Carrier level; tuning meter	82B100
	<u>CRYSTAL</u>	
X-1	455 kc crystal	19A123
	<u>JACKS</u>	
J-1	PHONO jack	36A029
J-2	PHONES jack	36E030
	<u>LINE CORD</u>	
	A-c line cord with two prong plug	87A078
	<u>MISCELLANEOUS COMPONENTS</u>	
	Tube shield (Miniature tube)	69A065
	Adjustable tuning core	77A068
	Gear drive assembly	71C177
	Main tuning dial	83C265
	Bandspread dial	83E267
	Bandspread dial escutcheon less window	7E019
	Bandspread escutcheon window	22A160
	Main tuning dial escutcheon less pointer	7D020
	Main tuning pointer	82A110
	Main tuning escutcheon fastener clip	76A364
	Bandspread escutcheon fastener clip	76A309

REMOTE CONTROL OPERATION:

Connect a single pole single throw relay to pins #5 and 8 on PL1 located on the rear apron

of the receiver. Receiver "SEND- RECEIVE" switch is then placed in "SEND" position. When the Transmitter is turned on the Receiver is automatically disabled.

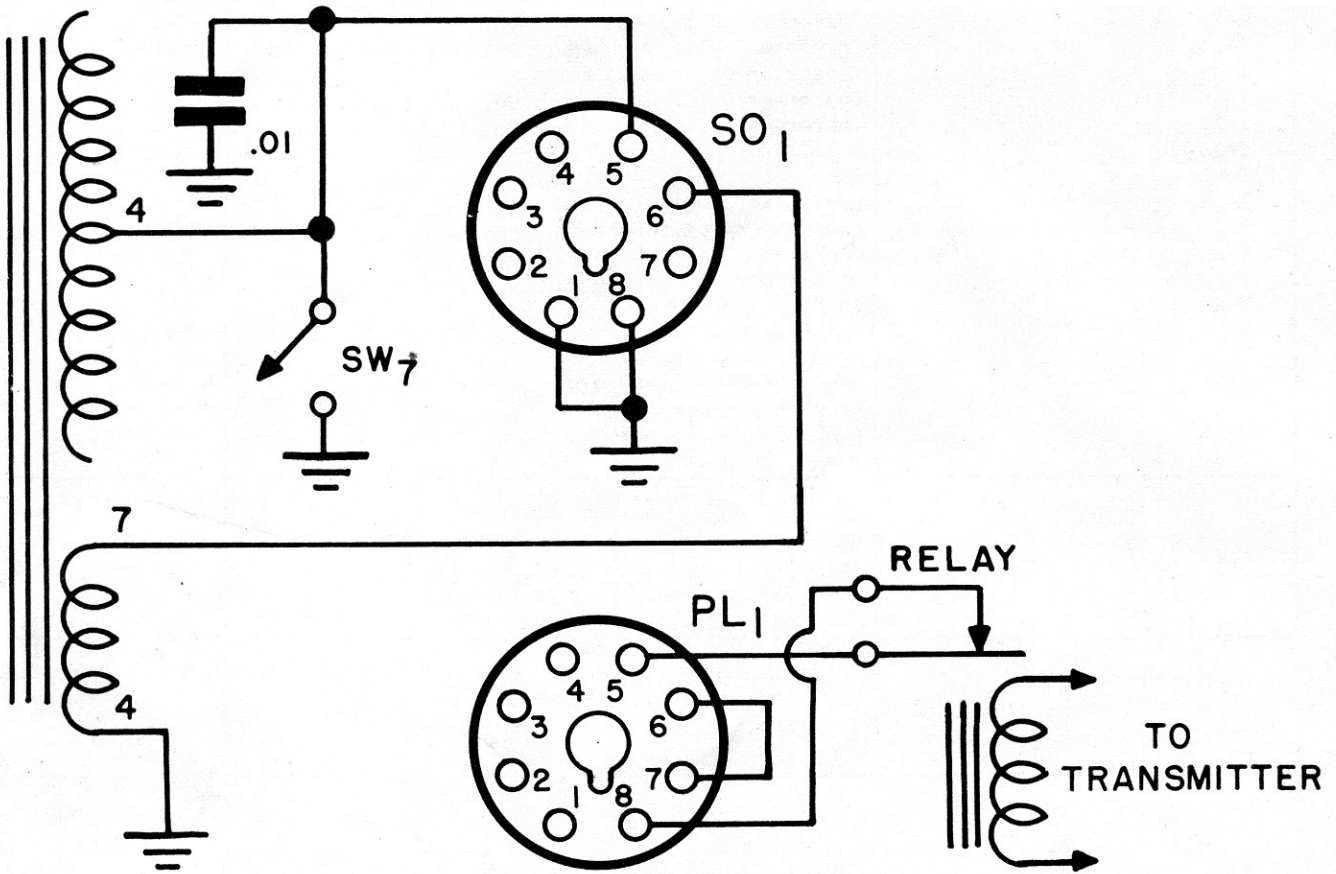

Figure 18. Schematic Remote Control Operation

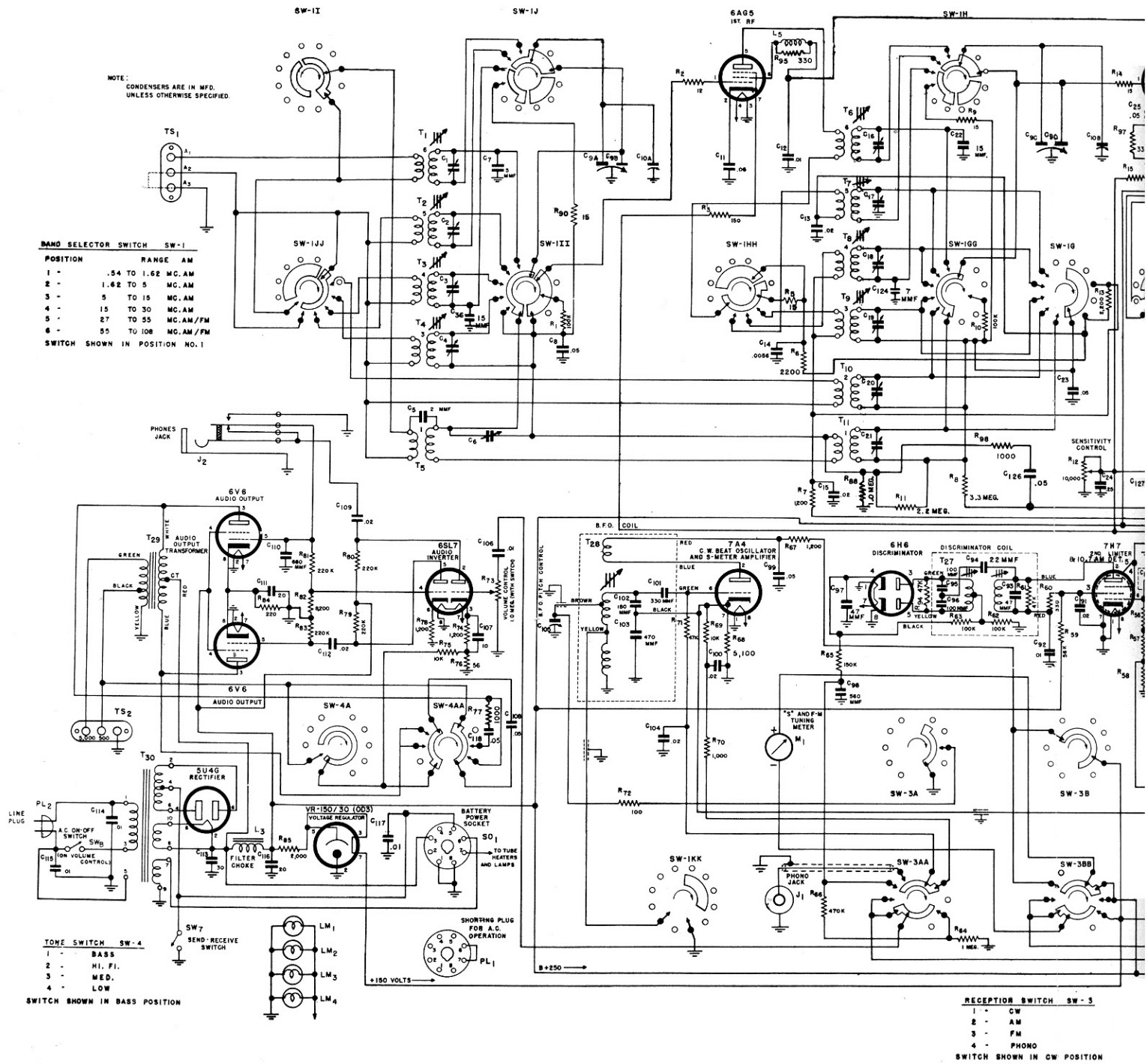
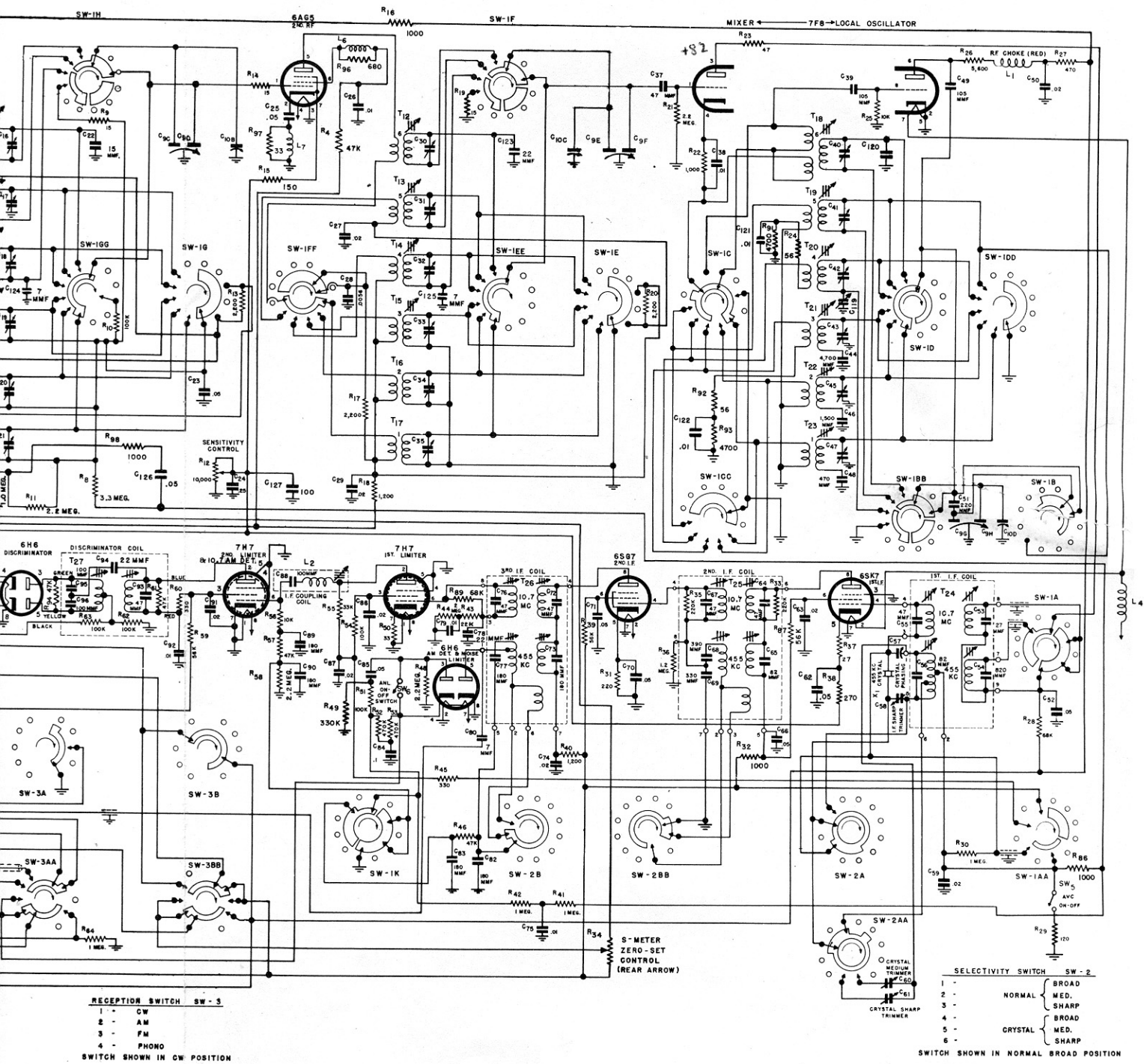

Figure 19. Model SX-42 Schematic W



RECEPTION SWITCH SW-3
 1 - CW
 2 - AM
 3 - FM
 4 - PHONO
 SWITCH SHOWN IN CW POSITION

SELECTIVITY SWITCH SW-2
 1 - BROAD
 2 - MED.
 3 - SHARP
 4 - BROAD
 5 - CRYSTAL
 6 - MED. SHARP
 SWITCH SHOWN IN NORMAL BROAD POSITION

89 D 210 - D

Model SX-42 Schematic Wiring Diagram

MODEL SX-42

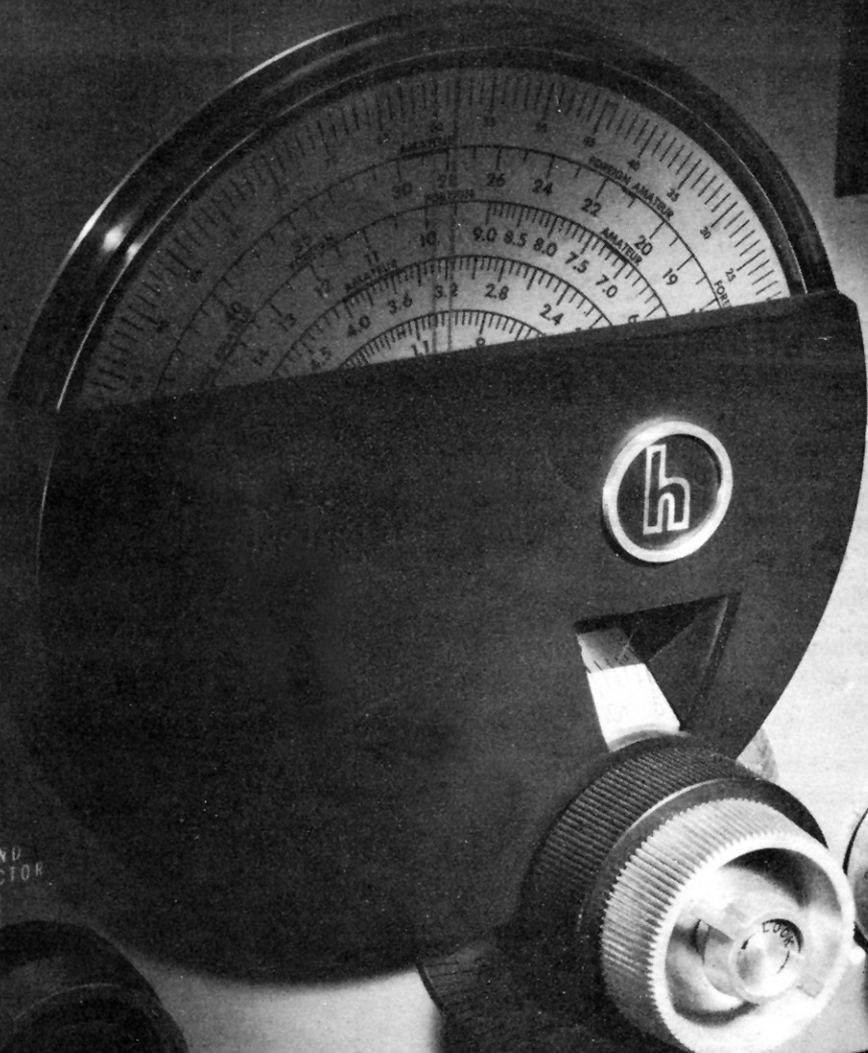

hallicrafters co. CHICAGO, ILL.

BAND SELECTOR

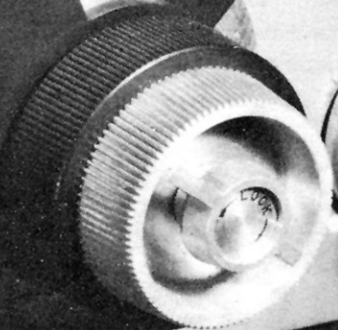
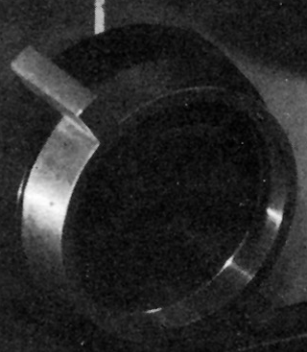

AVC



NOISE LIMITED AUTO. SEL.



450

devoted est.

VOL. XXX No.