

MICOM-H HF-SSB Transceiver

Amateur Mobile/Base Radio



Owner's Guide

Draft – October 2000

68MB000023

Table of Contents

Acronyms	v
Technical Specifications	vii
General	vii
Options	viii
Accessories	viii
Transmitter	ix
Receiver	x
Military and Industrial Standards	xi
FCC Information	xi
Information for Safe, Efficient Operation	xiii
Exposure to Radio Frequency Energy	xiii
Guidelines and Warnings	xiv
Restrictions	xiv
Before You Begin	1
Overview	3
The MICOM-H HF-SSB Radio	3
Options and Accessories	4
Transmission	4
Reception	4
Frequency Sources	5
Power Sources	5
CW Keying Operation	5
Radio Programming	5

Getting Started	7
The Front Panel	7
LED Indicators	7
Radio Display	8
Icon Indicators	8
The Rear Panel	9
Beeps	9
Basic Radio Operations	10
Function Keys	10
<i>Predetermined Numeric Value Mode</i>	10
<i>Toggle Mode</i>	10
Up/Down Scroll Keys	10
Scanning Wheel	10
Transmission/Reception Quality Aids	11
Conventions in this Manual	12
Procedures	12
Display Representation	12
Radio Operation	13
Basic Radio Procedures	13
PTT Types	14
<i>Bandwidth Filters</i>	15
Channel Mode	16
Channel Mode Options	17
Frequency Mode	18
<i>VFO Operation</i>	20
Frequency Mode Options	21
Storing Frequencies	22
Scan Mode	23
Scan Mode Options	24
Using the BITE (Built-In Test Equipment)	26
Locking the Radio	27

Display Brightness	29
Programming Mode	30
Display Language	30
Radio Programming	31
Programming Channels	32
Copying Channel Parameters	33
Erasing a Channel	34
Transmission Power Level	34
Channel Frequency	35
Band Types	36
Operating Modes	36
Automatic Gain Control (AGC)	37
Bandwidths	38
Radio Parameters	39
Baud Rate	39
Data Power	40
Microphone Side Tone	40
Accessory Side Tone	41
PTT Release Beep	41
Keyboard Beep	42
Tone Level	42
Alternate Display Time-out	43
Attenuator	43
CW Operation	44
Receive Level	44
Display Mode	45
Setting the Radio Options	46
Tuner	46
Accessory Settings	46

Maintenance	47
Preventative Maintenance	47
System Integrity	47
Periodic Calibration	47
Using BITE	47
<i>Maintenance Error Messages</i>	48
Troubleshooting	49
Service	51
Installation	53
General	53
Inspection	53
Planning the Installation of your Radio	53
Base Station Installation	54
Mobile Installation	55
Installation Procedures	55
Mobile Mounting Kit	56
DC Power Connection	57
Microphone Clip	58
Final Connections	58
External Speaker Installation	59
Operational Checks	59
Connectors	59
Microphone Connector J1	59
Antenna Connector J2	59
Accessory Connector J3	60
DC Connector J4	61
Reduction of Vehicular Noise	61
List of Procedures	lxiii

Acronyms

AGC	Automatic Gain Control
AME	Amplitude Modulation Equivalent
ARQ	Automatic Repeat Request
BITE	Built-In Test Equipment
CW	Continuous Wave
DSP	Digital Signal Processing
DTCXO	Digitally Temperature Controlled Crystal Oscillator
FEC	Forward Error Correction
FSK	Frequency Shift Keying
GND	Ground
HF	High Frequency
HSM	High Speed Modem
LED	Light Emitting Diode
LSB	Lower Side Band
LSM	Low Speed Modem
MCW	Modulated Continuous Wave
OCXO	Oven Controlled Crystal Oscillator
PEP	Peak Envelope Power
PLL	Phase Lock Loop
PTT	Push To Talk
RGC	Receiver Gain Control
RSS	Radio Service Software
RTTY	Radio Telex Teletype
SINAD	Signal to Signal Noise Distortion Ratio
SSB	Single Side Band
ULQ	Update Link Quality
USB	Upper Side Band
VFO	Variation Frequency Offset
VSWR	Voltage Standing Wave Ratio
XMIT	Transmit

Technical Specifications

General

The general technical specifications of the MICOM-H are:

Model Number	M82AMN0KV5-K				
Frequency range	Receiver: 100 kHz-30.000 MHz Transmit: 1.800-1.999999 MHz 3.500-3.999999 MHz 7.000-7.300 MHz, 10.100-10.150 MHz 14.000-14.350 MHz, 18.068-18.168 MHz 21.000-21.450 MHz, 24.890-24.990 MHz 28.000-29.700 MHz				
Number of channels	200; user programmable; simplex or half duplex				
Scanning	5 groups with up to 100 channels per group				
Frequency stability	0.6 PPM (0.1 PPM optional)				
Frequency drift (aging)	1 PPM per year				
Synthesizer lock time	10 msec max.				
Frequency resolution	10 Hz				
Audio bandwidths @ -6dB	Voice & Data:	350-2100 Hz, 350-2700 Hz, 350-3000 Hz, 350-3300 Hz			
	CW:	775-1025 Hz, 650-1150 Hz, 500-1300 Hz			
	Low speed data:	1450 to 1950 Hz			
Operating temperature range	-30°C to +60°C				
Humidity	95% @ 50°C				
Operating voltage	13.8 V DC \pm 20% Neg. Ground				
VFO	VFO operation				
Current drain @ 13.8 VDC:	Receive	Transmit			
	Squelch	Full Audio	Voice	2 Tone	1 Tone
Key down	1.7A	2.5A	14A	23A	28A
Dimensions and weight	Height	Width	Depth	Weight	
	mm/inch	mm/inch	mm/inch	Kg/Lb.	
	92/3.7	302/11.9	270/10.7	5.7/12.5	

Options

The following operational options can be added to the MICOM-H:

High stability oscillator	Enables frequency stability of 0.1 PPM. (Hardware option).
Noise Blanker	Helps to eliminate noise resulting from motor interference.
Remote control	Connection of the radio to a remote PC with radio controlled software.
Accessory Stop Scan	Enables stopping and resuming normal scanning from the accessory connector.
RS232 remote control interface	–
Linear amplifier interface	–
Phone patch interface	–
Data/Fax modem interface	–
MicomNet-internet gateway	–
Interlink interface	–
24 VDC operation	–

Accessories

The following accessories can be added to the MICOM-H

CW key and headphones	–
Phone patch	–
Interlink (FM-HF repeater)	–
Automatic Antenna Tuner	–
Continuous duty kit	–
AC power supply	–
Antennas and grounding kit	–
Data/fax modem	–
Mobile mounting kit	–
Desk Microhone	–

Transmitter

The MICOM-H transmits signals in accordance with the following specifications:

Output power	125W P.E.P. and average
Reduced power levels	25W, 62W, 100W (RSS programmable)
Audio bandwidth ripple	3 dB
Intermodulation	-31 dB/P.E.P (-35 dB/P.E.P Typical*)
Harmonic emissions	-64 dB/P.E.P (-70 dB/P.E.P Typical*)
Spurious emissions	-64 dB/P.E.P (-70 dB/P.E.P Typical*)
Carrier suppression	-50 dB/P.E.P
Undesired sideband suppression	-55 dB/P.E.P
Audio distortion	2.5%
1/2 power microphone sensitivity	25 to 125 mV (RMS)/600 Ohms
Hum & ripple	-50 dB
Inband noise	-60 dB (30 Hz BW)
Tx/Rx switching time	10 msec

*. Values noted as "Typical" are valid over 90% or more of the frequency range.

Receiver

The MICOM-H receives signals in accordance with the following specifications:

Sensitivity (SINAD) SSB (voice)	0.5 mV for 10 dB SINAD (0.35 mV Typical)* 0.1 - 1.6 MHz reduced performance
1/2 rated power sensitivity	1 mV for 2.5W audio @ speaker
Selectivity	-6 dB @ 350 to 2700 Hz -60 dB @ -1 kHz; +4 kHz
Image rejection	-80 dB
IF rejection	-85 dB
Undesired sideband rejection	-55 dB @ -1 kHz
Spurious rejection	-80 dB
Cross modulation rejection	-100 dB @ 100 kHz
Desensitization	-100 dB @ 100 kHz
Reciprocal mixing	-100 dB @ 100 kHz
Audio power @ speaker	5W @ 2.5% distortion
RGC range	5mV-1V (2 dB change in output level)
RGC time constants	
Voice	Attack time 10 msec Release time 1500 msec
CW/Data	Attack time 10 msec Release time 10 msec
Squelch	Constant SINAD (digital)
RIT variable range (Clarifier)	±200 Hz in 10 Hz steps
Preselector sections	Sub-octave (1.6 MHz to 30 MHz range)
Maximum antenna input	20 kV maximum transient, 100V RMS for 2 minutes

*. Values noted as "Typical" are valid over 90% or more of the frequency range.

Military and Industrial Standards

The MICOM-H meets the following US military and industrial standard requirement for adverse environmental conditions (without the need of external shock mounts)

Environmental Condition	US Military STD 810C	US Military STD 810D	US Military STD 810E
Vibration	Method 514.2	Method 514.3	Method 514.4
Shock	516.2	516.3	516.4
Rain	506.1	506.2	506.3
Dust	510.1	510.2	510.3
Salt Fog	509.1	509.2	509.3

The MICOM-H also meets the EIA-RS152B for shock, vibration and applicable test procedures, US FCC for channel occupancy, spurious, interference and frequency tolerance. It is manufactured according to the demanding standards of ISO 9000 and EMC (Electromagnetic Compatibility).

FCC Information

The following FCC information is applicable for the MICOM-H:

Emissions	J3E, R3E, H3E, J2A, J2B
FCC applicable parts of rules	15, 18, 90
FCC type acceptance number	ABZ9QCC1635
With high stability option	ABZ9QCC1634

Information for Safe, Efficient Operation

Exposure to Radio Frequency Energy

In August 1996, the Federal Communications Commission (FCC) adopted updated RF energy exposure guidelines for wireless products regulated by the FCC. These guidelines are consistent with the safety standards previously set by both U.S. and international standards bodies. The design of your Motorola radio complies with the FCC guidelines and these standards:

- American National Standards Institute (C95.1-1992)
- National Council on Radiation Protection and Measurements (NCRP-1986)
- International Commission on Non-Ionizing Radiation Protection (ICNRP-1986).

To assure optimal radio performance and to ensure that exposure to RF energy is within the guidelines in the above standards, install antennas correctly, following recommended installation procedures.

Guidelines and Warnings

Symbols



The Warning symbol denotes a hazard. It calls attention to a procedure or practice that could result in personal injury, damage to the radio or loss of programmed information, if not performed correctly.



The Important symbol denotes a procedure or practice to which a particular attention should be paid.



The Note symbol calls your attention to additional information.

Restrictions

Because this radio contains a transmitter, federal law prohibits unauthorized, non-licensed personnel from adjusting or maintaining it. If any operational difficulties should arise while using this product, report them to authorized service personnel as soon as possible.



Do not attempt any unauthorized modification to the radio.

Before You Begin

This manual is designed to acquaint you with the features, care, and installation of your radio, to better serve your communication needs.

The manual includes general descriptions as well as step-by-step procedures.

Before you begin using the radio, we recommend that you read the following chapters:

- Overview
- Getting Started
- Operating Instructions

Theoretical explanations are included in Overview, and later sections of this manual assume familiarity with these functions.

Basic aspects of radio use, for instance keypad functionality, are covered in detail in Getting Started. Later sections of this manual assume familiarity with such functions, and do not repeat instructions for common actions.

Overview

Welcome to the Motorola HF-SSB radio family! Your choice of a MICOM-H radio means that you have selected the highest of standards in design, quality, and performance.

The compact sized MICOM-H is an advanced ruggedized Digital Signal Processing (DSP) HF all-band transceiver intended for very wide area radio communications. It combines sophisticated voice, data, fax and e-mail solutions with a high signal quality and reliability, while remaining very simple to operate.

The MICOM-H HF-SSB Radio

Your radio includes the following features:

- Scanning wheel
- Ruggedized mobile/fixed transceiver
- High MBTF
- Variable bandwidth for optimal signal processing
- Digital Signal Processing (DSP)
- Selectable front-end attenuator
- Excellent frequency stability
- Small size, light weight
- Sub-octave pre-selector
- RF power indicator
- Programmable channel scan
- Automatic IF shift
- Excellent transmitter and receiver performance
- Conforms to MIL-STD 810 and EIA specifications
- Meets FCC and EMC standards
- VFO operation
- Adaptable internal configuration options
- Security access code
- Multi-language Liquid Crystal Display (LCD)
- Built-In Test Equipment (BITE)
- Enhanced voice quality
- Selectable power output
- Variable notch filter
- Front panel programming
- Voice-activated digital squelch
- Priority and guard channels
- Digital noise blanking and clarifier
- 200-channel capacity, simplex or half-duplex
- Complies with ISO 9001 requirements

Options and Accessories

You can add the following operational options and/or accessories to your radio:

- High frequency stability option
- Linear amplifier interface
- Data/fax modem interface
- RSS for PC
- Phone patch
- Automatic antenna tuners
- AC power supply
- Antennas and grounding
- CW key and headphones
- RS232 remote control interface
- Phone patch interface
- Interlink interface
- High (0.1 PPM) frequency stability
- Interlink
- Continuous duty data trans. kit
- 1 KW amplifier
- Data/fax modems
- 24V Operation kit

Transmission

The maximum output power of the transmitter is 125W PEP (Peak Envelope Power), with an average transmission duty cycle of 1 to 4, thus enabling even the CW (Continues Wave) signal to be transmitted at the maximum available power. Output power can be preprogrammed to one of four possible levels: 25W, 62W, 100W and 125W. Accurate sensors are used to keep the output power within the nominal value.

The radio includes mismatch protection. If the VSWR (Voltage Standing Wave Ratio) rises to more than 2:1, the transmitter is inhibited in order to avoid any damage and a relevant message is displayed.

The transmitter is thermally protected. If the transmitter internal temperature exceeds the maximum permitted temperature, the output power is automatically reduced to avoid any fault due to excessive heat.

Reception

The radio utilizes Digital Signal Processing (DSP) to implement reception functions such as demodulation, narrow filtering, automatic gain control, noise blanking and squelch.

The automatic digital noise blanker is activated whenever repetitive noise (e.g. ignition spikes) is encountered in the received signal. The digital syllabic (speech identifier) squelch is activated whenever speech is identified, thus opening the audio path. However, if speech is not received, the audio path is muted, thus preventing background noise from disturbing the operator.

Frequency Sources

Two types of frequency sources are available for the MICOM-H radio. The standard 0.6 PPM DTCXO frequency source which assures a frequency stability of better than ± 18 Hz. For frequencies lower than 10 MHz, it assures a frequency stability of better than ± 6 Hz.

When higher frequency stability is required, the G478 0.1 PPM OCXO frequency source can be ordered. It will assure a frequency stability of better than ± 3 Hz at 30 MHz.

Power Sources

The radio is designed for $13.8\text{ V} \pm 20\%$ negative-ground operation and may be connected to a standard 12 V battery, or with the optional kit to a power supply of $24\text{ V} \pm 25\%$.

CW Keying Operation

When the CW key is pressed, the radio transmits a continuous wave (at the full programmed power) and stops transmission when the key is released.

CW keying operation is enabled by connecting the Morse key between CW (pin #10) and ground (pin #18) at the accessory connector. If you wish to operate CW keying with external headphones, use the CW cable supplied with the radio. This will enable a standard PL55 headphone and standard PL99 Morse key to be connected to the accessories connector.

Radio Programming

The following radio features can be programmed:

- Up to 200 simplex/half duplex channels at SSB (J3E), AME (H3E), or Pilot (R3E) modes of transmission.
- Up to four levels of output power (up to 125W PEP and average).
- Five scanning groups of up to 200 channels, each with a guard channel.

Most radio functions can be programmed directly from the front panel of the radio as described in the *Radio Programming* chapter.

Getting Started

The Front Panel

The MICOM-H includes a 5W external speaker and a scanning wheel, as well as the following controls:

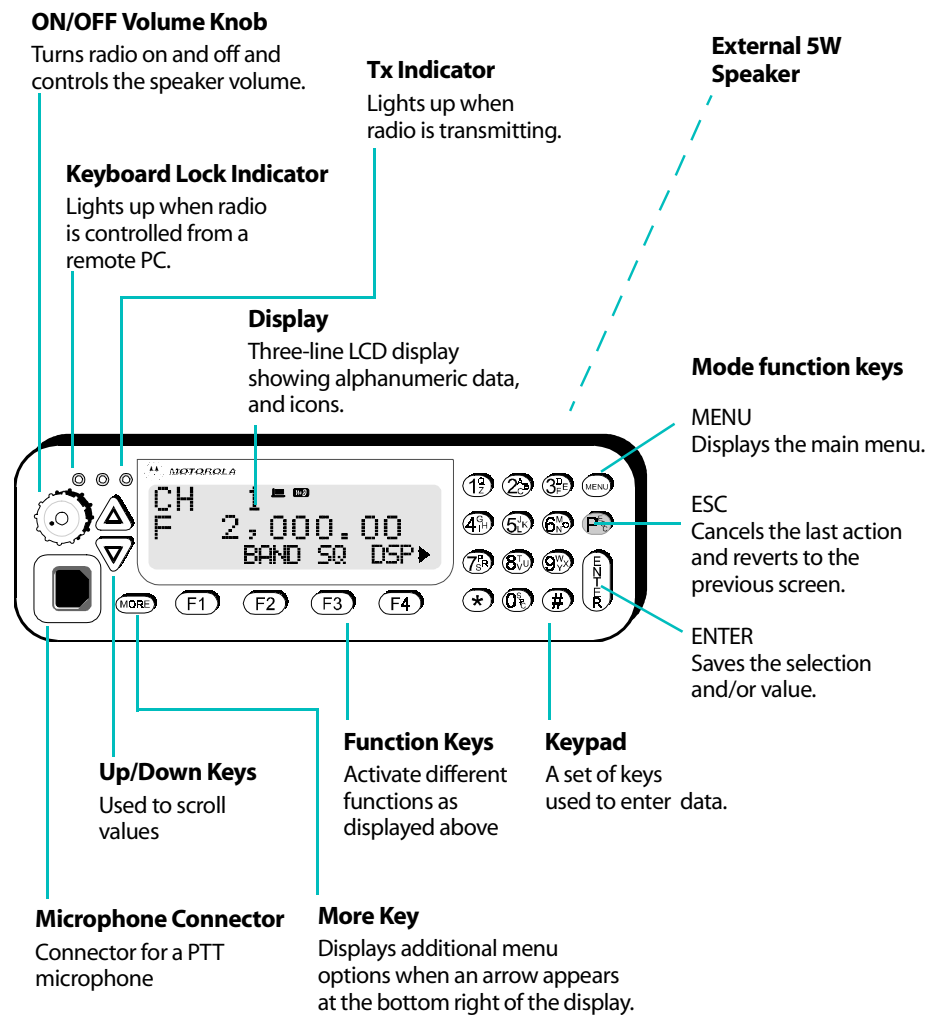

Figure 1: Radio Front Panel

LED Indicators

The LEDs, located on the left hand-side of the control head, indicate radio operating conditions (from left to right):

Color	LED	Indicates
Yellow	Remote control	Keyboard lock
Orange		(not used)
Red	Tx	Transmission

Radio Display

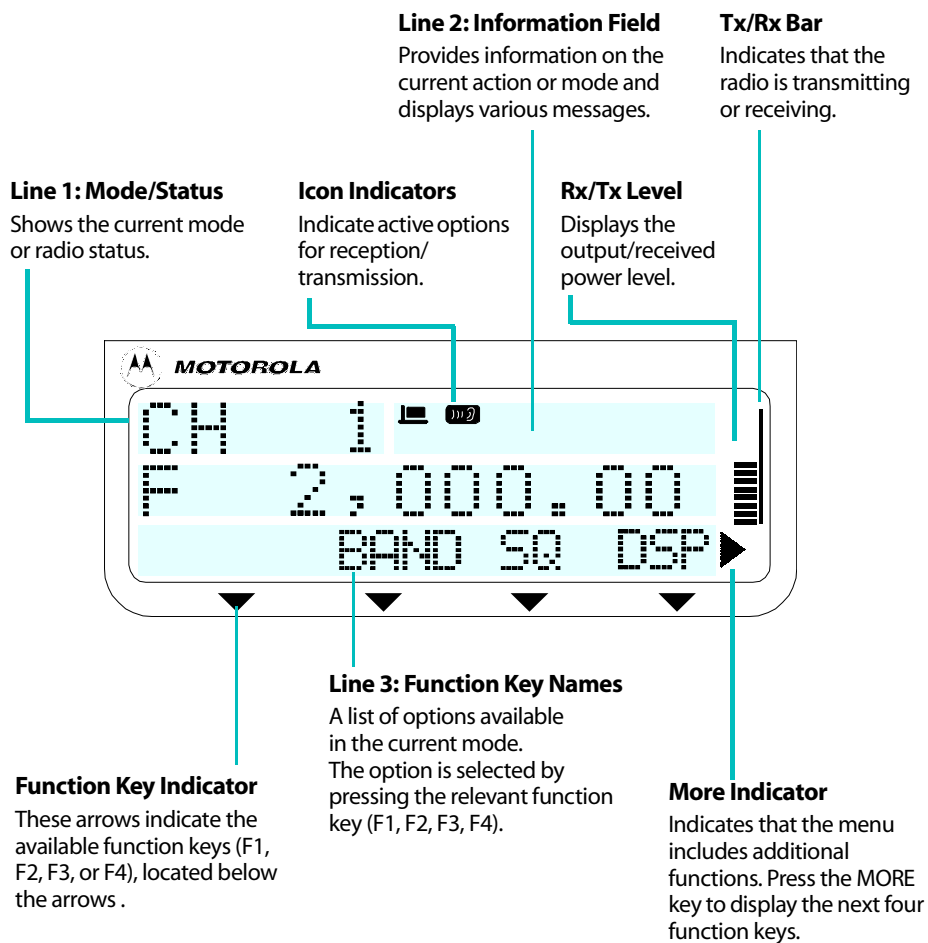

Icon Indicators

There are nine icons that can appear in the upper right area of the display. The icons appear in the following order:

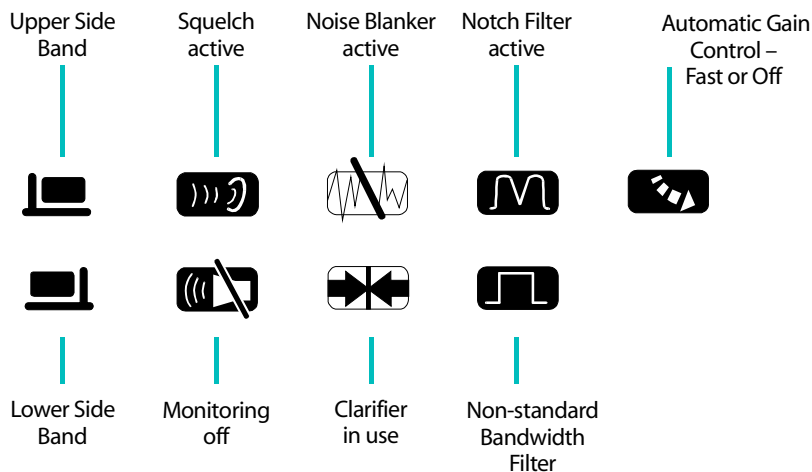

The Rear Panel

The rear panel of the MICOM-H includes the following connectors:

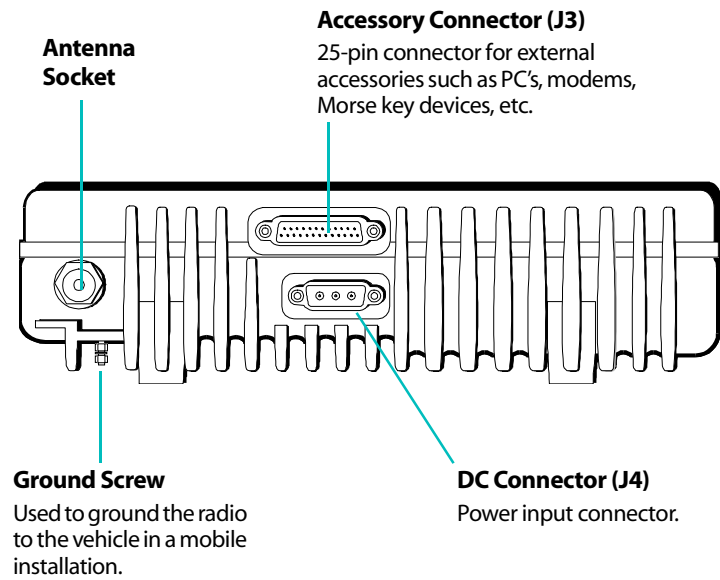

Beeps

The MICOM-H can be set to beep when the keys on the front panel are pressed, indicating that the key press has been registered. A different beep can be heard when the PTT button of the remote radio is released, indicating that the other party to the call has completed transmission and that you can now transmit.

You can enable or disable these beeps, and can set their volume (PTBP and KBBP functions in Radio Programming).

Basic Radio Operations

Function Keys

The function keys (F1, F2, F3, F4) are used to select a wide variety of options, which depend on the current radio mode. An acronym or abbreviation denoting the current function is displayed in the bottom line of the display, above the relevant key.

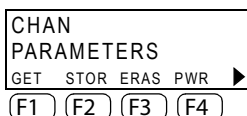

If a certain function key is not available (for instance if the radio is locked), the space above the key will remain blank, and the key will not function.

Predetermined Numeric Value Mode

When there is a parameter for which there are predetermined values, F1 enters the lowest possible value (minimum or OFF); F4 enters the highest possible value and F2 and F3 increment or decrement the value.



 *You can not use the keypad to enter the value for this type of parameter.*

Toggle Mode

When the function being set is a yes/no toggle, one function key will be **YES** and another **NO**.

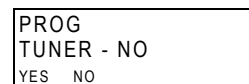

Up/Down Scroll Keys

The **UP/DOWN** scroll keys are used to scroll between values that are already programmed into the radio.

For example, in Channel mode you can view the programmed channels: A single keypress on the **UP/DOWN** scroll keys displays the next or previous channel respectively; pressing either key continuously browses among the channels, four channels per second.

In Frequency mode the **UP/DOWN** scroll keys are used to change the frequency.

When programming, you can use the **UP/DOWN** scroll keys to scroll between the different programmable parameters.

Scanning Wheel

The scanning wheel is used to scan the available frequencies. It can also be used instead of the **UP/DOWN** scroll keys to scroll between values that are already programmed into the radio.

Transmission/ Reception Quality Aids

The MICOM-H offers you a variety of aids which can be used in different circumstances to improve the quality of transmission/reception. When these options are activated, the appropriate icon appears in the icon display.

Squelch

When Squelch is activated, the radio switches the speaker on only when it identifies speech, silencing reception noise at all other times.

Noise Blanker

Reduces repetitive cyclic noise such as motor interference when the radio is working in a vehicle.

Clarifier

When there is a deviation in the frequency of the broadcasting radio, the receive frequency can be modified using the clarifier.

Notch Filter

When an undesired continuous tone is evident in reception, the Notch Filter can eliminate that specific tone, retaining all other tones.

Non-Standard Bandwidth Filter

Adapts the reception/transmission bandwidth in accordance with the type of signal received/transmitted.

Automatic Gain Control Fast/Off

The Fast AGC function can be used for receiving certain types of data in order to prevent data distortion. When receiving a voice message, the AGC should be set to slow (icon not displayed).

Conventions in this Manual

Procedures

Procedures are step-by-step instructions that tell you how to operate specific aspects of the radio. Procedures in this manual have a bold-face heading beginning with the word “**To...**”.

Steps are accompanied by a representation of the radio’s display, to the right of the step. These representations always reflect the state of the radio display *after* the relevant step has been made.

When front panel keys are to be pressed to execute a step, the keys are highlighted in this manner: **ENTER**. When function keys are used, the function itself, as displayed on the screen, is highlighted, in this manner: **CHAN** (F1).



When you can perform a step in more than one way, you will see the word “or” on its own line, and then an alternate method of performing the step.

When a procedure begins with a series of steps common to all procedures in that section, the series of steps is represented in an abbreviated manner, with a > sign indicating the next step.

For instance, the following string represents five key presses:
MENU > MORE > PROG (F2) > **RAD** (F1) > **CHAN** (F1).

Display Representation

The display is presented in schematic form. The icons are enlarged in order to facilitate easy identification, so that they do not represent the actual position of the icon on the radio display.

CH 1		
BW 2.7		
2.1	2.7	3.0 3.3

Radio Operation

This chapter provides instructions on operation of the MICOM-H, and includes subjects such as turning the radio on, transmitting and receiving, channel mode, frequency mode, scan mode, built in test equipment, radio locking, display language and display brightness.

Basic Radio Procedures

To turn the radio on:

Turn the **ON/OFF/VOLUME** knob clockwise until it clicks.



The words SELF TEST are displayed for about three seconds.



When the self-test procedure is completed, the display enters the last operating mode used: CH, SCAN, or FREQ.



If the self-test procedure fails, the first line indicates the error number. The second line blinks, with a short description of the error (see page 48 for a list of error messages).

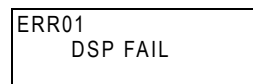

Use the **UP/DOWN** keys to scroll to additional messages, if any.

To Transmit:**Note**

Before transmitting, ensure that the RF output of the radio is connected to a tuned antenna or to a dummy load.

To transmit, press and hold down the Push-To-Talk (PTT) button on the side of the handset and speak slowly and clearly. This method of transmission is used regardless of the type of transmission (voice, data or Morse), and regardless of whether you are in Channel, Frequency or Scan mode.

The Tx LED will remain lit until the PTT button is released to indicate that you are transmitting.

When you press the PTT button, the RF power and Tx bar are displayed.

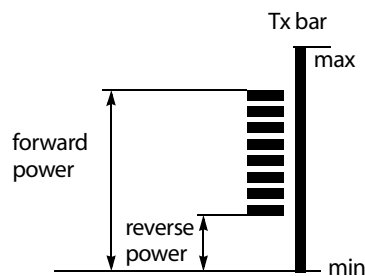
**To Receive:**

The default radio mode is Receive mode.

You can program the radio to display an Rx bar similar to the Tx bar, see “Receive Level” (page 44).

PTT Types

The radio can receive and transmit four different types of PTT:

Data PTT, Voice PTT, CW PTT or MIC PTT.

The radio automatically identifies the transmitted PTT type according to the type of device connected to the accessory port, and identifies MIC if a microphone is connected to the front panel.

**Note**

When using CW PTT, the squelch should be set to OFF.

Bandwidth Filters

Unless a particular filter is set for the current channel, the radio retains the previously used filter. When a new type of call is received or sent, the bandwidth filter changes automatically, depending on the PTT source (voice, data or CW), and the programmed bandwidth for the channel being used.

Bandwidth set to:	Filter changes after:
LSM (data modem)	first data PTT
2.1 K (voice + data)	microphone or voice PTT
2.7 K (voice + data)	microphone or voice PTT
3.0 K (voice + data)	microphone or voice PTT
3.3 K (voice + data)	microphone or voice PTT
CW (Morse)	first CW PTT

When the bandwidth filter is set to CW, the following CW bandwidths can be set in the radio's Programming mode, see "CW Operation" (page 44):

- 0.25 K
- 0.5 K
- 0.8 K

Channel Mode

Channel mode is used to select a channel which is already programmed in the radio, in order to transmit/receive calls on that channel.

You can also operate a variety of functions and options to facilitate good transmission and reception.

To choose a channel:



Note

*In order to choose the priority channel, you must be in Channel mode. To enter channel mode, press **MENU** > **CHAN** (F1) and confirm by pressing **ENTER**. To access the priority channel preprogrammed by the RSS, press **ESC** momentarily.*

1. If you are not in Channel mode, press **MENU** to display the menu screen, and press **CHAN** (F1).

MENU
CHAN FREQ SCAN BIT

The last active channel number is displayed, blinking.

2. If you wish to use the displayed channel, press **ENTER**.

CH 1

OR

Select a channel by pressing the **UP/DOWN** keys until you reach the required channel, or use the keypad to enter the channel number.

CH 2
BACK CLR

The channel number blinks, indicating that the selection has not yet been confirmed.



Note

If you enter a channel that is not programmed, a “NOT PROG” message appears. To program a new channel, see “Programming Channels” (page 32), or use the RSS software.

3. When the desired channel is displayed, press **ENTER** to confirm your choice.

To transmit in Channel mode:

1. If you are not in Channel mode, press **MENU** to display the menu screen, and press **CHAN** (F1).

MENU
CHAN FREQ SCAN BIT

2. Choose a channel (see above).

3. To initiate transmission, press the PTT button.

Channel Mode Options

In Channel mode, you can operate functions and options to eliminate noise and assist reception and/or transmission. The icon display reflects the options selected.



Note

The change of channel options is temporary. When you next change the currently used channel, all current parameters will be lost.

TXM (F1) enables you to view and listen to the channel transmit frequency (visible for duplex and Tx only channels).

BAND (F2) toggles between upper side band (USB) and lower side band (LSB).

SQ (F3) toggles the squelch (on/off).

DSP (F4) accesses the Digital Signal Processing menu, which includes:

- **CLAR** (F1) clarifier (off/less/more)
* not available for Tx Only channels
- **NF** (F2) notch filter (off/less/more)
* not available for CW or Tx Only channels
- **CLIP** (F3) clipper (on/off)
- **NB** (F4) noise blanker (on/off)
* optional, to be purchased separately
- **ATTN** (MORE, F2) attenuator (on/off).

PWR (MORE, F1) power level selection (low, med, high or max).

MODE (MORE, F2) operation mode selection (SSB, AME or PLT).

AGC (MORE, F3) automatic gain control (fast/slow/off).

BW (MORE, F4) bandwidth selection (2.1 K, 2.7 K, 3.0 K, 3.3 K, LSM or CW; CW includes bandwidths 0.25 K, 0.5 K and 0.8 K, see “CW Operation” (page 44)).

RCLV (MORE, MORE, F1) displays the reception level when F1 is pressed.
*If the reception is programmed as OFF, this option does not appear, see “Receive Level” (page 44).

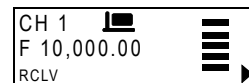
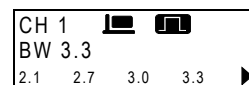
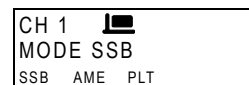
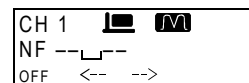
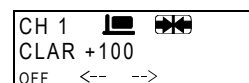

Frequency Mode

Frequency mode is used to receive and transmit on a specific frequency. You can select the frequency type, change the frequency being used, and operate a variety of functions and options to facilitate good transmission and reception. You can also store the frequency in a channel of your choice.



Notes

- Frequency mode is accessible only if the radio is not locked.
- When setting a new frequency, use the * key on the keypad as a decimal point.

There are four frequency types:

- *SMPX (Simplex Frequency)* – the same frequency is used for transmission and reception. The frequency can not be zero.
- *DPLX (Duplex Frequency)* – transmits on one frequency and receives on a different frequency. The frequencies can not be zero.
- *R XO (Receiving Only Frequency)* – defines a frequency for reception only.
- *T XO (Transmitting Only Frequency)* – defines a frequency for transmission only.

The available frequency ranges are:

Reception: 100 kHz-30.000 MHz

Transmission: 1.800-1.999999 MHz

3.500-3.999999 MHz

7.000-7.300 MHz, 10.100-10.150 MHz

14.000-14.350 MHz, 18.068-18.168 MHz

21.000-21.450 MHz, 24.890-24.990 MHz

28.000-29.700 MHz

To enter frequency mode:

1. Press **MENU** to display the Menu screen.

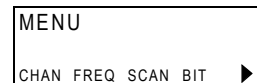

2. Press **FREQ (F2)**. The last active frequency blinks, and the frequency type is displayed in the top line.



The letter preceding the frequency in the second line of the display indicates whether the frequency is Transmission (T), Reception (R) or both transmission and reception (F).

3. If you wish to use the displayed frequency and frequency type, press **ENTER**.

OR

Change the frequency type and the frequency as required (see “To change the current frequency/frequencies” (page 19)).

To change the current frequency/frequencies:

1. If you are not in frequency mode, press **MENU** to access the menu screen, and press **FREQ** (F2).

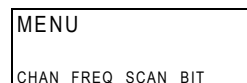

The last active frequency blinks, and the frequency type is displayed in the top line.

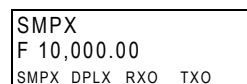

OR

If you are already in frequency mode, press **MORE** until the T/R function appears above the F1 function key, and press **T/R** (F1).



The current frequency type is displayed in the top line, and the used frequencies are displayed.

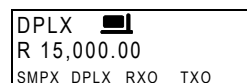

2. If necessary, change the frequency type by pressing the relevant function key:

SMPX (F1), **DPLX** (F2), **RXO** (F3) or **TXO** (F4).



Note

Different frequency types may have default frequency setting which will appear automatically when that frequency type is selected.

3. If you are using SMPX, RXO or TXO frequency type, and you wish to use the displayed frequency, press **ENTER**.
OR use the scanning wheel, keypad or **UP/DOWN** keys to enter a new frequency.

The frequency number blinks, indicating that the selection has not yet been confirmed.
Press **ENTER** to confirm your choice.

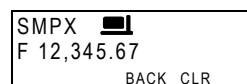

4. If you are using DPLX frequency type, the frequency displayed first is the Rx frequency. If you want to use the displayed frequency, press **ENTER**.

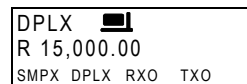

OR use the scanning wheel, keypad or **UP/DOWN** keys to enter a new frequency.

The frequency number blinks, indicating that the selection has not yet been confirmed.
Press **ENTER** to confirm your choice.

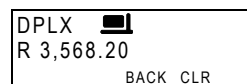

After confirmation of the Rx frequency, the display blinks with the Tx frequency. If you want to use the displayed Tx frequency, press **ENTER**.



OR use the scanning wheel, keypad or **UP/DOWN** keys to enter a new frequency.

The frequency number blinks, indicating that the selection has not yet been confirmed.
Press **ENTER** to confirm your choice.



5. Press **ENTER** to confirm the frequency type and the frequencies you have set.



VFO Operation

VFO (Variation Frequency Offset) is available in Simplex mode, and enables you to operate simultaneously on two different channels (A and B).

Using the A/B function, you can “freeze” the frequency of channel A, switch to channel B and return to channel A again.

Using the A=B option, you can copy the frequency in the current channel to the alternate channel.

1. If you are not in frequency mode, press **MENU** to access the menu screen, and press **FREQ** (F2).

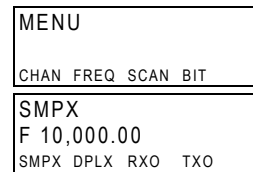

The last active frequency blinks, and the frequency type is displayed in the top line.

OR

If you are already in frequency mode, press **MORE** until the T/R function appears above the F1 function key, and press **T/R** (F1).

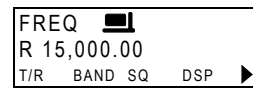

The current frequency type is displayed in the top line, and the used frequencies are displayed.

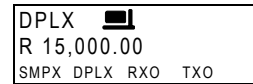

2. If necessary, change the frequency type to Simplex by pressing **SMPX** (F1).
3. If you wish to use the displayed frequency, press **ENTER**.

OR use the scanning wheel, keypad or **UP/DOWN** keys to enter a new frequency.

The frequency number blinks, indicating that the selection has not yet been confirmed.

When the desired frequency is displayed, press **ENTER** to confirm your choice.



4. Press **MORE** until the A/B and A=B functions appear above the F1 and F2 function keys.

Press **A/B** (F1) to alternate between the two channels.

Press **A=B** (F2) to copy the frequency of the current channel to the alternate channel.

Press **<--** (F3) and **-->** (F4) to move the cursor backwards and forwards.

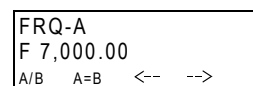

When these arrows are used in conjunction with the scanning wheel or the **UP/DOWN** scroll keys, the frequency scrolls according to the location of the cursor, enabling you to change the frequency with greater ease.

For instance, if the frequency is 7,500.54 and the cursor is at the hundreds location (7,_00.54), pressing the scanning wheel or the **UP/DOWN** scroll keys will scroll the hundreds values to 7,400.54; 7,600.54; 7,700.54 and so on.

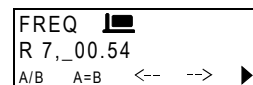

Frequency Mode Options

In Frequency mode, you can operate functions and options to eliminate noise and assist reception and/or transmission. The icon display reflects the options selected.

T/R (F1) sets the transmit and receive frequencies and frequency type.



BAND (F2) toggles between upper side band (USB) and lower side band (LSB).



SQ (F3) toggles the squelch (on/off).



DSP (F4) accesses the Digital Signal Processing menu, which includes:



- **CLAR** (F1) clarifier (off/less/more)
* *not available for Tx Only channels*

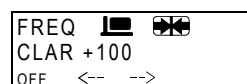

- **NF** (F2) notch filter (off/less/more)
* *not available for CW or Tx Only channels*

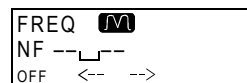

- **CLIP** (F3) clipper (on/off)



- **NB** (F4) noise blanker (on/off)
* *optional, to be purchased separately*



- **ATTN** (MORE, F2) attenuator (on/off).

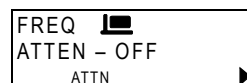

PWR (MORE, F1) power level selection (low, med, high or max).



MODE (MORE, F2) operation mode selection (SSB, AME or PLT).



AGC (MORE, F3) automatic gain control (fast/slow/off).



BW (MORE, F4) bandwidth selection (2.1 K, 2.7 K, 3.0 K, 3.3 K, LSM or CW; CW includes bandwidths 0.25 K, 0.5 K and 0.8 K, see “CW Operation” (page 44)).

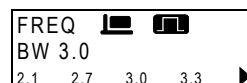

RCLV (MORE, MORE, F1) displays the reception level when F1 is pressed.

**If the reception is programmed as OFF, this option does not appear, see “Receive Level” (page 44).*

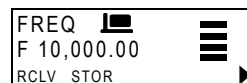

STOR (MORE, MORE, F2) stores the frequency parameters in the selected channel.



Storing Frequencies

You can store specific frequencies and frequency parameters in channels which you have programmed (see “Programming Channels” (page 32)).

To store a frequency in a channel:

1. If you are not in Frequency mode, press **MENU** to display the Menu screen.

```
MENU
CHAN  FREQ  SCAN  BIT  ►
```

2. Press **FREQ** (F2).
The last active frequency blinks, and the frequency type is displayed in the top line.

```
SMPX
F 10,000.00
SMPX  DPLX  RXO  TXO
```

3. If you wish to use the displayed frequency and frequency type, press **ENTER**. If the Frequency type is Duplex, press **ENTER** twice to accept both transmission and reception frequencies.

OR

Change the frequency type and the frequency as required (see “To change the current frequency/frequencies” (page 19)).

4. If necessary, set other parameters, using the **MORE** key and pressing the required function keys (see “Frequency Mode Options” (page 21)).
5. Press **MORE** twice, and press **STOR** (F2).

```
FREQ  [BLINK]
R 15,000.00
RCLV  STOR  ►
```

6. Select a channel using the scanning wheel, keypad or **UP/DOWN** keys until you reach the required channel, or use the keypad to enter the channel number.

```
FREQ  [BLINK]
STORE CH 5
BACK  CLR
```

7. When the desired channel is displayed, press **ENTER** to confirm your choice.

```
FREQ
STORING
```

The frequency parameters are stored in the selected channel.

Scan Mode

In Scan mode, the radio scans the programmed scan channels. Up to five scan groups (A to E) can be created via the RSS, each containing up to 200 channels. When a guard channel is selected, it is monitored after every other scanned channel.

To use scan mode:

1. Press **MENU** to display the menu screen.



2. Press **SCAN** (F3).
The last active group blinks (A).

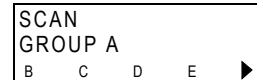

Note

If there are no defined groups, the message “NO GROUPS” appears in the display.

3. If you want to use the currently displayed scan group, press **ENTER**

OR

Press the function key beneath the group you want to choose and press **ENTER** to confirm your choice.



Notes

1. In scan mode, one of the five groups is always selected, and the other four groups are displayed over the function keys.
2. If the selected group is not programmed, the message “GRP X EMPTY” appears in the display (X being the selected group).

Scan Mode Options

In Scan mode various parameters and options can be set, using the function keys.



Note

The change of options is temporary. When you resume scanning, all changed parameters will be lost.

To select scan mode options:

STOP (F1) stops scanning.

```

STOP  █
GROUP A 59
SCAN BAND SQ GRP ▶
  
```

SLOW (F2) decreases the scan speed.

FAST (F3) increases the scan speed.

```

SCAN  █
RATE 4 sec
STOP SLOW FAST GRP ▶
  
```



Note

The scan speed can be: 1 to 5 seconds, 1 second per step; or 150 to 950 milliseconds, 50 milliseconds per step.

```

SCAN  █
RATE 900 ms
STOP SLOW FAST GRP ▶
  
```

GRP (F4) enables selection of a scan group.

```

SCAN
GROUP A
B   C   D   E
  
```

When scanning has been stopped, you can use the following options:

SCAN (F1) activates scanning.

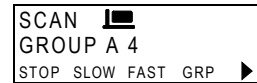

BAND (F2) toggles between upper side band (USB) and lower side band (LSB).

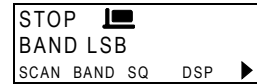

SQ (F3) toggles the squelch (on/off).



DSP (F4) accesses the Digital Signal Processing menu, which includes:



- **CLAR** (F1) clarifier (off/less/more)
* *not available for Tx Only channels*

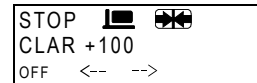

- **NF** (F2) notch filter (off/less/more)
* *not available for CW or Tx Only channels*

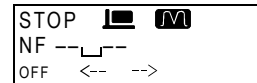

- **CLIP** (F3) clipper (on/off)



- **NB** (F4) noise blanker (on/off)
* *optional, to be purchased separately*



- **ATTN** (MORE, F2) attenuator (on/off)



PWR (MORE, F1) power level selection (low, med, high or max)



MODE (MORE, F2) operation mode selection (SSB, AME or PLT)



AGC (MORE, F3) automatic gain control (fast/slow/off)



BW (MORE, F4) bandwidth selection (2.1 K, 2.7 K, 3.0 K, 3.3 K, LSM or CW; CW includes bandwidths 0.25 K, 0.5 K and 0.8 K, see "CW Operation" (page 44)).

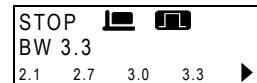

Using the BITE (Built-In Test Equipment)

BITE is a testing tool used for radio maintenance and troubleshooting.

To run BITE:

1. Press **MENU** to display the menu screen.

```
MENU
CHAN  FREQ  SCAN  BIT  ►
```

2. Press **BIT** (F4).

In BITE mode, you can run the following tests:

```
BITE
FULL  CHAN  L.RF
```

- **FULL** (F1) runs a full test of the hardware device
- **CHAN** (F2) tests the device on the current channel frequencies
- **L.RF** (F3) low RF; tests the low RF path.

3. While BITE is in progress, the message “IN TEST...” is displayed. The number of periods indicates the progress of the test.

```
BITE
IN TEST...
```

4. If the test passes successfully, the name of the test and the word PASS are displayed.

```
BITE
L.RF – PASS
FULL  CHAN  L.RF
```

5. If BITE detects a malfunction, the error number is displayed in the first line of the display and a short description of the error appears in the second line. See page 48.

```
ERR23
PRESELECTOR
EXIT
```

6. Press the **UP/DOWN** scroll keys to see if there are additional error messages.
7. Press **EXIT** (F1) to exit Error mode.

Locking the Radio Lock mode enables you to lock the radio using a password, so that programming and frequency modes are not accessible.

The lock password is a number of up to six digits. The default factory-defined password is 123456. See “To change the password” (page 28) for details on defining a new password.



Note

If you enter the wrong password, the error message “WRONG PSW!” is displayed.

To lock the radio:

1. Press **MENU** to display the menu screen.
2. Press **MORE** to scroll to the second menu screen.
3. Press **LOCK** (F1).
4. Enter the password to lock the radio.
5. Press **O.K.** (F1) or press the **ENTER** key to confirm.

```
MENU
CHAN  FREQ  SCAN  BIT  ►
```

```
MENU
LOCK  PROG  PSW  DIM  ►
```

```
LOCK
PSW:
```

```
LOCK
PSW:*****
O.K.  <--  CLR
```

```
LOCK
  LOCKED
```

To unlock the radio:

1. Press **MENU** to display the menu screen.

```
MENU
CHAN          SCAN  BIT  ►
```



Note

*When the radio is locked, not all functions are available. For instance, the F2 key, which is usually used to access **FREQ**, is blank.*

2. Press **MORE** to scroll to the second menu screen.
3. Press **OPEN** (F1).
4. Enter the password number to unlock the radio.
5. Press **O.K.** (F1) or press the **ENTER** key to confirm.

```
MENU
OPEN          PSW  DIM  ►
```

```
UNLCK
PSW:
```

```
UNLCK
PSW:*****
O.K.  <--  CLR
```

```
UNLCK
  UNLOCKED
```

To change the password:

For security reasons, you may want to change your password, used to lock the radio.

1. Press **MENU** to display the menu screen.

```
MENU
CHAN  FREQ  SCAN  BIT  ►
```

2. Press **MORE** to scroll to the second menu screen.

```
MENU
LOCK  PROG  PSW  DIM  ►
```

3. Press **PSW** (F3).

```
PSW
OLD:
```

4. Enter the old password, using the keypad.

```
PSW
OLD:*****
O.K.  <--  CLR
```

**Notes**

– If you have not yet set a password, the radio has a factory-defined password which is 123456.

– When you enter the correct password, you are prompted to enter your new password.

5. Enter the new password, using the keypad.

```
PSW
NEW:*****
O.K.  <--  CLR
```

6. Press **ENTER** to confirm.

```
PSW
PSW SAVED
```

Display Brightness

The DIM function can control the brightness of the display. There are four levels of brightness, ranging from 0 (dimkest) to 3 (brightest).



Note

You can only change the display brightness if the display is programmed to DIM. If the display is programmed as ALT (see “Display Mode” (page 45)), the display is normally turned off, and automatically turns on at a predetermined level when the radio detects any type of activity (scanning wheel, keypad, PTT, incoming call, etc.).

To change the display brightness level:

1. Press **MENU** to display the menu screen.
2. Press **MORE** to scroll to the second menu screen.
3. Press **DIM** (F4) repeatedly until you reach the desired brightness level.

```
MENU
CHAN  FREQ  SCAN  BIT  ►
```

```
MENU
LOCK  PROG  PSW  DIM  ►
```

```
MENU
DIM LEVEL 3
LOCK  PROG  PSW  DIM  ►
```

Programming Mode

Most programmable parameters are accessible through programming mode.

In programming mode you can set radio programmable parameters (see “Radio Programming” (page 31)) and the display language.

Display Language

The radio display can be in the following languages:

- English
- French
- Spanish

To change the radio language:

1. Press **MENU** to display the menu screen.
2. Press **MORE** to scroll to the second menu screen.
3. Press **PROG** (F2) to enter Program mode.
4. Press **LANG** (F3) to display the Language screen.
5. Press **ENG** (F1) for English.
Press **FRNC** (F2) for French.
Press **SPAN** (F3) for Spanish.
6. Press **ENTER** to confirm.

```
MENU
CHAN  FREQ  SCAN  BIT  ►
```

```
MENU
LOCK  PROG  PSW  DIM  ►
```

```
PROG
RAD      LANG
```

```
LANG
ENGLISH
FRNC  SPAN
```

Radio Programming

The MICOM-H is already configured for use at the time of purchase. However, you may wish to change the configuration to suit your own needs or to reflect changes in the environment or networks. The radio can be programmed through the front panel (if the radio is not locked), or using the appropriate RSS (Radio Service Software).



If the message “NOT PROGRAM” is displayed after the self test, you cannot enter programming mode, and the radio must be programmed through the RSS.

The following sections relate to programming of radio parameters using the front panel.

After locating the required radio parameter in the programming menu, you can change it by pressing the function key under the parameter name

OR

you can press the **UP/DOWN** keys to scroll through the parameters.

To enter Radio Programming mode:

1. Press **MENU** to display the menu screen.
2. Press **MORE** to scroll to the second menu screen.
3. Press **PROG** (F2) to enter Program mode.
4. Press **RAD** (F1) to enter Radio Programming mode.

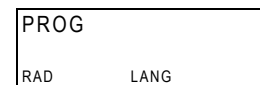
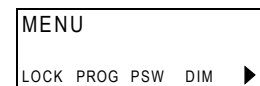
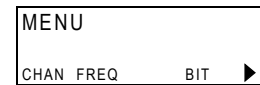

In this menu, you can program:

- channels
- radio parameters
- radio options

The following sections explain the programming procedures in detail.

Programming Channels

When programming channels, you can use the following options:

- GET – Retrieve preprogrammed channel parameters
- STOR – Store channel parameters
- ERAS – Erase programmed channel
- PWR – Tx power level
- FREQ – Frequency
- BAND – Band type
- MODE – Mode of operation
- AGC – Automatic Gain Control
- BW – Bandwidth

The use of each option is explained in the following sections.

When you enter Channel programming, the channel parameters have the following default values:

- Rx Frequency – 15,000.00 kHz
- Tx Frequency – 15,000.00 kHz
- Band – USB
- Bandwidth – 2.7
- Tx Power – Max
- AGC Type – Slow
- Mode – SSB

When programming a new channel, you do not need to define all parameters – change only those for which the default values are not suitable.

Copying Channel Parameters

GET and **STOR** are used to copy all channel parameters from one channel to another.

To copy channel parameters:

1. Access the Channel Programming menu:
MENU > MORE > PROG (F2) > RAD (F1) > CHAN (F1).

```
CHAN 
PARAMETERS
GET  STOR ERAS PWR ▶
```

2. Press **GET** (F1) to retrieve all parameters from an existing channel.
The last active channel number is displayed, blinking.

```
PROG
GET CHAN 1
```

3. With the keypad, enter the number of the channel whose parameters you want to copy.

```
PROG
GET CHAN 13
      BACK CLR
```

OR

Use the scanning wheel or the **UP/DOWN** scroll keys to select the channel whose parameters you want to copy.

4. Press **ENTER** to confirm.

```
CHAN 
PARAMETERS
GET  STOR ERAS PWR ▶
```

5. Press **STOR** (F2) to store the retrieved channel parameters in a different channel.

```
PROG
STORE CH 1
```

The last active channel number is displayed, blinking.

6. With the keypad, enter the number of the channel into which you wish to save the copied parameters.

OR

Use the scanning wheel or the **UP/DOWN** scroll keys to select the channel into which you wish to save the copied parameters.

7. Press **ENTER** to confirm.

```
PROG 
      STORING
```

Erasing a Channel

ERAS is used to delete a channel from the radio.

To erase a channel:

1. Access the Channel Programming menu:
MENU > MORE > PROG (F2) > RAD (F1) > CHAN (F1).

```
CHAN  █
PARAMETERS
GET  STOR ERAS PWR ▶
```

2. Press **ERAS (F3)**.

The last active channel number is displayed, blinking.

```
PROG  █
ERASE CH 1
```

3. With the keypad, enter the channel number you want to delete.

```
PROG  █
ERASE CH 31
      BACK CLR
```

OR

Use the scanning wheel or the **UP/DOWN** scroll keys to select the channel you wish to delete.

4. Press **ENTER** to confirm.

```
PROG  █
      ERASING
```



Notes

- If the channel is not programmed, you will receive a "NOT PROG" message.

In all these cases, the erase request is rejected by the radio.

Transmission Power Level

You can set one of four transmission power levels for a programmed channel:

- LOW – 25W
- MED – 62.5W (medium)
- HIGH – 100W
- MAX – 125W (maximum)

To set the channel's transmission power level:

1. Access the Channel Programming menu:
MENU > MORE > PROG (F2) > RAD (F1) > CHAN (F1).

```
CHAN  █
PARAMETERS
GET  STOR ERAS PWR ▶
```

2. Press **PWR (F4)** to access the power level options.

```
PROG  █
POWER LOW
LOW  MED  HIGH  MAX
```

3. Press the function key that appears below the power level of your choice:
LOW (F1), MED (F2), HIGH (F3) or MAX (F4).

4. Press **ENTER** to confirm.

Channel Frequency

The Channel Frequency setting enables you to determine the specific frequency for each channel, and the frequency type:

Simplex Frequency (SMPX) – transmits and receives on the same frequency.

Duplex Frequency (DPLX) – transmits on one frequency and receives on a different frequency.

Receiving Only Frequency (RXO) – restricts a frequency for reception only.

Transmitting Only Frequency (TXO) – restricts a frequency for transmission only.

To set a channel's frequency:

1. Access the Channel Programming menu:
MENU > **MORE** > **PROG** (F2) > **RAD** (F1) > **CHAN** (F1).



2. Press **MORE** to scroll to the second menu screen.



3. Press **FREQ** (F1) to access the frequency options.



4. Press the function key below the frequency type of your choice:
SMPX (F1), **DPLX** (F2), **RXO** (F3) or **TXO**(F4).



Note

When the DPLX function is selected, the F2 key toggles between Rx and Tx frequencies.

5. Use the keypad to enter the frequency of your choice.



Note

*Use the * key as a decimal point if you need to program the 100 Hz and 10 Hz digits after the decimal point.*

6. Press **ENTER** *twice* to confirm.

Band Types

MICOM-H has two band types:

- USB – upper side band
- LSB – lower side band.

To set the channel band type:

1. Access the Channel Programming menu:
MENU > MORE > PROG (F2) > RAD (F1) > CHAN (F1).
2. Press **MORE** to scroll to the second menu screen.
3. Press **BAND (F2)** to access band type options.
4. Press the function key below the option of your choice (**USB** or **LSB**).
5. Press **ENTER** to confirm.

```

CHAN  █
PARAMETERS
GET  STOR ERAS PWR ▶

```

```

CHAN  █
PARAMETERS
FREQ BAND MODE AGC ▶

```

```

PROG  █
BAND - LSB
USB  LSB

```

Operating Modes

The MICOM-H offers three operating mode options:

- SSB – single side band
- AME – amplitude modification equivalent
- PLT – pilot mode.

To set the operating mode:

1. Access the Channel Programming menu:
MENU > MORE > PROG (F2) > RAD (F1) > CHAN (F1).
2. Press **MORE** to scroll to the second menu screen.
3. Press **MODE (F3)** to access operation mode options.
4. Press the function key below the operation mode of your choice:
SSB (F1), AME (F2) or PLT(F3).
5. Press **ENTER** to confirm.

```

CHAN  █
PARAMETERS
GET  STOR ERAS PWR ▶

```

```

CHAN  █
PARAMETERS
FREQ BAND MODE AGC ▶

```

```

PROG  █
MODE SSB
SSB  AME  PLT

```

Automatic Gain Control (AGC)

The MICOM-H supports two AGC speeds: slow and fast, or the AGC can be turned off.

To set the AGC speed:

1. Access the Channel Programming menu:
MENU > MORE > PROG (F2) > RAD (F1) > CHAN (F1).



2. Press **MORE** to scroll to the second menu screen.



3. Press **AGC (F4)** to access AGC speed settings.



4. Press the function key below the AGC speed of your choice:
SLOW (F1), FAST (F2) or OFF (F3).



Note

If you choose FAST, the AGC FAST icon will be visible.



5. Press **ENTER** to confirm.

Bandwidths

The MICOM-H offers the following bandwidths:

- 2.1 K
- 2.7 K
- 3.0 K
- 3.3 K
- LSM – Low Speed Modem
- CW – Continuous Wave, including:
 - 0.25 K
 - 0.5 K
 - 0.8 K

To set the channel bandwidth:

1. Access the Channel Programming menu:
MENU > MORE > PROG (F2) > RAD (F1) > CHAN (F1).



2. Press **MORE** twice to scroll to the third menu screen.



3. Press **BW** (F1) to access the bandwidth options.

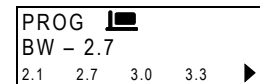

4. Press the function key below the bandwidth of your choice:
2.1 (F1), 2.7 (F2), 3.0 (F3) or 3.3 (F4).

5. If you want to set the radio to **LSM** or **CW**, press the **MORE** key.
Select **LSW** (F1) or **CW** (F2).



6. Press **ENTER** to confirm.



Note

The standard bandwidth is 2. If you choose any other bandwidth, the Non-Standard bandwidth icon will be visible.

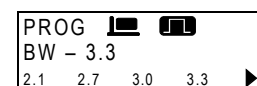

Radio Parameters You can program the following radio parameters:

- BAUD – Baud rate
- DPWR – Data power
- MST – Microphone Side Tone
- AST – Accessory Side Tone
- PTBP – PTT Release Beep
- KBBP – Keyboard Beep
- TONE – Tone level
- ADT – Alternate Display Time-out
- ATTN – Attenuator
- CW – Continuous Wave
- RCLV – Receive Level
- DIM – Dimming Mode

The definition of each of the parameters is explained in the following sections.

Baud Rate

The MICOM-H provides four baud rates:

- 1200 bps
- 2400 bps
- 4800 bps
- 9600 bps.

These baud rates are used when the radio is to communicate with external devices such as: RSS, E-mail and remote control.

To set the baud rate:

1. Access the Radio Parameters Programming menu:
MENU > MORE > PROG (F2) > RAD (F1) > PRMT (F2).
2. Press **BAUD (F1)** to access baud rate options.
3. Press the function key below the baud rate of your choice:
 - 1.2 (F1)** - 1200 bps
 - 2.4 (F2)** - 2400 bps
 - 4.8 (F3)** - 4800 bps
 - 9.6 (F4)** - 9600 bps
4. Press **ENTER** to confirm.

RADIO
PARAMETERS
BAUD DPWR MST AST ▶

PROG
BAUD – 2400
1.2 2.4 4.8 9.6

The message “WAIT...” appears on the display for a few seconds.

PROG
WAIT . . .
1.2 2.4 4.8 9.6

Data Power

The MICOM-H provides four data power levels:

- LOW – 25W
- MED – 62.5W (medium)
- HIGH – 100W
- MAX – 125W (maximum).

When data PTT is used, the radio sets the transmitter power level to the minimum possible value between the determined data power value and the power level of the currently used channel.

To set the data power level:

1. Access the Radio Parameters Programming menu:
MENU > MORE > PROG (F2) > RAD (F1) > PRMT (F2).
2. Press **DPWR (F2)** to access the data power options.
3. Press the function key below the power level of your choice:
LOW (F1), MED (F2), HIGH (F3) or MAX(F4).
4. Press **ENTER** to confirm.

```
RADIO
PARAMETERS
BAUD DPWR MST AST ▶
```

```
PROG
DT PWR – LOW
LOW MED HIGH MAX
```

Microphone Side Tone

You can enable or disable the microphone side tone, which echoes the transmitted voice from the MIC PTT to the speaker.

To enable/disable the Microphone Side Tone (MST):

1. Access the Radio Parameters Programming menu:
MENU > MORE > PROG (F2) > RAD (F1) > PRMT (F2).
2. Press **MST (F3)** to access the Microphone Side Tone options.
3. Press **YES (F1)** to enable or **NO (F2)** to disable the microphone sidetone.
4. Press **ENTER** to confirm.

```
RADIO
PARAMETERS
BAUD DPWR MST AST ▶
```

```
PROG
MIC ST-NO
YES NO
```

Accessory Side Tone You can enable or disable the accessory side tone, which echoes the transmitted voice from the accessory entry to the speaker.

To enable/disable the Accessory Side Tone (AST):

1. Access the Radio Parameters Programming menu:
MENU > MORE > PROG (F2) > RAD (F1) > PRMT (F2).

RADIO
PARAMETERS
BAUD DPWR MST AST ▶

2. Press **AST (F4)** to access the Accessory Side Tone options.

PROG
ACC ST-NO
YES NO

3. Press **YES (F1)** to enable or **NO (F2)** to disable the accessory sidetone.
4. Press **ENTER** to confirm.

PTT Release Beep

You can enable or disable the transmission of a beep when the push-to-talk (PTT) button is released. The PTT release beep function is used to indicate to the remote station that the local radio has returned to receive mode, (i.e. that it can begin transmitting).

To enable/disable the PTT Release Beep (PTBP):

1. Access the Radio Parameters Programming menu:
MENU > MORE > PROG (F2) > RAD (F1) > PRMT (F2).

RADIO
PARAMETERS
BAUD DPWR MST AST ▶

2. Press **MORE** for the second menu screen.

RADIO
PARAMETERS
PTBP KBBP TONE ADT ▶

3. Press **PTBP (F1)** to access the PTT Beep Release options.

PROG
PTT BP-NO
YES NO

4. Press **YES (F1)** to enable or **NO (F2)** to disable the beep.
5. Press **ENTER** to confirm.

Keyboard Beep

You can enable or disable the keypad beep, which beeps every time a valid key is pressed.

To enable/disable the Keyboard Beep (KBBP):

1. Access the Radio Parameters Programming menu:
MENU > MORE > PROG (F2) > RAD (F1) > PRMT (F2).

```
RADIO
PARAMETERS
BAUD DPWR MST AST ▶
```

2. Press **MORE** for the second menu screen.

```
RADIO
PARAMETERS
PTBP KBBP TONE ADT ▶
```

3. Press **KBBP (F2)** to access the Keyboard Beep options.

```
PROG
KYB BP-NO
YES NO
```

4. Press **YES (F1)** to enable or **NO (F2)** to disable the keypad beep.
5. Press **ENTER** to confirm.

Tone Level

You can set the tone level (volume) to high or low.

To set the tone level:

1. Access the Radio Parameters Programming menu:
MENU > MORE > PROG (F2) > RAD (F1) > PRMT (F2).

```
RADIO
PARAMETERS
BAUD DPWR MST AST ▶
```

2. Press **MORE** for the second menu screen.

```
RADIO
PARAMETERS
PTBP KBBP TONE ADT ▶
```

3. Press **TONE (F3)** to access the Tone options.

```
PROG
TONE - HIGH
LOW HIGH
```

4. Press **LOW (F1)** to set to low volume or **HIGH (F2)** to set to high volume.
5. Press **ENTER** to confirm.

Alternate Display Time-out

You can define the number of seconds that elapse before the menu display returns to the previous screen.

To set the display time-out:

1. Access the Radio Parameters Programming menu:
MENU > MORE > PROG (F2) > RAD (F1) > PRMT (F2).
2. Press **MORE** to scroll to the second menu screen.
3. Press **ADT (F4)** to access the time-out setting display.
4. Press **<-- (F2)** to decrement the displayed value by 1.
Press **--> (F3)** to increment the displayed value by 1.
Press **1 (F1)** to quick-set the value to 1.
Press **10 (F4)** to quick-set the value to 10.
5. Press **ENTER** to confirm.

```
RADIO
PARAMETERS
BAUD DPWR MST AST ▶
```

```
RADIO
PARAMETERS
PTBP KBBP TONE ADT ▶
```

```
PROG
ADT - 5 SEC
1 <-- --> 10
```

Attenuator

You can enable or disable the attenuator.

To enable/disable the attenuator:

1. Access the Radio Parameters Programming menu:
MENU > MORE > PROG (F2) > RAD (F1) > PRMT (F2).
2. Press **MORE** *twice* to scroll to the third menu screen.
3. Press **ATTN (F1)** to access the attenuator options.
4. Press **YES (F1)** to enable or **NO (F2)** to disable the attenuator.
5. Press **ENTER** to confirm.

```
RADIO
PARAMETERS
BAUD DPWR MST AST ▶
```

```
RADIO
PARAMETERS
ATTN CW RCLV DIM ▶
```

```
PROG
ATTEN - NO
YES NO
```

CW Operation

You can select one of three CW frequency filters: 0.25 K, 0.5 K or 0.8 K.

To select a CW frequency filter:

1. Access the Radio Parameters Programming menu:
MENU > MORE > PROG (F2) > RAD (F1) > PRMT (F2).
2. Press **MORE** *twice* to scroll to the third menu screen.
3. Press **CW** (F2) to access the CW filters.
4. Press **0.25** (F1), **0.5** (F2) or **0.8** (F3) as required.
5. Press **ENTER** to confirm.

```
RADIO
PARAMETERS
BAUD DPWR MST AST ▶
```

```
RADIO
PARAMETERS
ATTN CW RCLV DIM ▶
```

```
PROG
CW - 0.8
0.25 0.5 0.8
```

Receive Level

You can enable or disable the Receive Level (Rx) bar.

To enable/disable the receive level bar:

1. Access the Radio Parameters Programming menu:
MENU > MORE > PROG (F2) > RAD (F1) > PRMT (F2).
2. Press **MORE** *twice* to scroll to the third menu screen.
3. Press **RCLV** (F3) to change the Rx bar status.
4. Press **YES** (F1) to enable or **NO** (F2) to disable the Rx bar.
5. Press **ENTER** to confirm.

```
RADIO
PARAMETERS
BAUD DPWR MST AST ▶
```

```
RADIO
PARAMETERS
ATTN CW RCLV DIM ▶
```

```
PROG
Rx LEVEL - NO
YES NO
```

Display Mode

You can select one of two display modes:

Dimming mode enables you to select one of four constant display light levels.

In **Alternate mode** the display is normally turned off, and automatically turns on at a predetermined level when the radio detects any type of activity (scanning wheel, keypad, PTT, incoming call, etc.).

To select the Dimming or Fixed display modes:

1. Access the Radio Parameters Programming menu:
MENU > MORE > PROG (F2) > RAD (F1) > PRMT (F2).
2. Press **MORE** *twice* to scroll to the third menu screen.
3. Press **DIM** (F4) to select the display mode.
4. Press **YES** (F1) for Alternate mode or **NO** (F2) for Dimming mode.
5. Press **ENTER** to confirm.

```
RADIO
PARAMETERS
BAUD DPWR MST AST ▶
```

```
RADIO
PARAMETERS
ATTN CW RCLV DIM ▶
```

```
PROG
DISPLAY - ALT
YES NO
```

Setting the Radio Options

The MICOM-H offers the following programmable radio options:

- TUNE – Tuner
- ACC – Accessory

Tuner

The radio can be set to work with or without a tuner. If you are using a tuner, you must set this option to YES.

To set the tuner on or off:

1. Access the Radio Options Programming menu:

MENU > **MORE** > **PROG** (F2) > **RAD** (F1) > **OPTS** (F3).

RADIO
OPTIONS
TUNE ACC

2. Press **TUNE** (F1) to access the tuner options.

PROG
TUNER – NO
YES NO

3. Press **YES** (F1) to set the tuner option on or **NO** (F2) to set the tuner option off.
4. Press **ENTER** to confirm.

Accessory Settings

The radio can be set to work with or without a 400W/1KW amplifier.

To set the amplifier option on or off:

1. Access the Radio Options Programming menu:

MENU > **MORE** > **PROG** (F2) > **RAD** (F1) > **OPTS** (F3).

RADIO
OPTIONS
TUNE ACC

2. Press **ACC** (F2) to access the accessory options.

PROG
ACC – NONE
AMP ACC1 ACC2 NON

3. Press the function key below the option of your choice:
AMP (F1), **ACC1** (F2), **ACC2** (F3).

Press **NON** (F4) if there is no accessory being used.



Note

***ACC1** (F2) and **ACC2** (F3) are for future use.
Selecting these options will have no effect.*

4. Press **ENTER** to confirm.

Maintenance

This section provides maintenance information for the MICOM-H. Correct installation and maintenance will ensure on-going operation of your radio set.

If an internal problem is suspected, the BITE (Built In Test Equipment) will assist you in locating the source of the problem and in informing your service representative.

Preventative Maintenance

System Integrity

Periodically check the integrity of your system, by examining the power source, cables, coaxes, connectors, antenna tuner (if used) and antenna. Carefully check that no damage has been caused to your cables, pay extra attention to runway through holes and bent cables.

Periodic Calibration

To maintain the frequency accuracy of your radio, the internal frequency source must be calibrated after 3, 6 and 12 months of operation in the first year, and once a year thereafter. Please ensure that your radio is calibrated on time.

Using BITE

Every time the radio is turned on, a self-test procedure is activated. If an internal malfunction is found, an error message will be displayed. Please contact your service representative and report the indicated malfunction or error. A list of possible error messages is given on page 48.

Maintenance Error Messages	
No.	Description
00	O.K. - no errors
01	DSP boot checksum fail (download)
02	DSP PLL unlock
03	DSP external RAM memory
04	(Not applicable)
05	DSP internal RAM memory
06	(Not applicable)
07	(Not applicable)
08	HC16 flash memory checksum
09	HC16 RAM memory
10	No 16.8 MHz clock
11	Battery low
12	Control head wake-up
13	Control head is not responding
14	Radio not programmed
15	Database fail
16	VCO 1 first injection
17	VCO 2 first injection
18	VCO 3 first injection
19	VCO second injection
20	Synthesizer unlock
21	Receiver failure
22	Preselector range 1
23	Preselector range 2
24	Preselector range 3
25	Preselector range 4
26	Preselector range 5
27	Preselector range 6
28	Preselector range 7
29	Preselector range 8
30	Exiter test
31	Antenna mismatch
32	Harmonic filter range 1
33	Harmonic filter range 2
34	Harmonic filter range 3
35	Harmonic filter range 4
36	Harmonic filter range 5
37	Harmonic filter range 6
38	Harmonic filter range 7
39	Power amplifier fail

Troubleshooting

If the radio is malfunctioning, try to solve the problem as follows:

Problem	Troubleshooting
<i>Blank Display</i>	Check whether: <ul style="list-style-type: none"> • DC power cable is connected properly to the radio and battery. • A 7.5A fuse is installed in the fuse holder located on the green wire of the DC power cable.
<i>Display present but weak or no receive signal or noise</i>	Check whether: <ul style="list-style-type: none"> • Connection of antenna to antenna tuner and antenna tuner to radio cables (loose or broken connections). • Correct programming of operating channel (frequency, mode of operation, etc.).
<i>Engine noise picked up by the antenna</i>	Determine by observing difference in the reception by turning the Engine ON/OFF. Verify that: <ul style="list-style-type: none"> • The ground leads are properly connected, all power wires and ground leads are as short as possible • The Noise Blanker (if installed) is enabled. If the problem persists: <ul style="list-style-type: none"> • Install noise reduction Kit TLN8845.
<i>Poor or no transmission</i>	Check whether: <ul style="list-style-type: none"> • A 30A fuse is installed in the fuse holder located on the red wire of the power cable. • Proper grounding cables are connected from the radio and from the antenna tuner to the vehicle chassis. • While speaking, check RF power bars for activity. The resulting RF power output is displayed in approximately 15 W increments (bars) being added from the bottom of the display upwards. • Three or more bars disappear from the RF power bar display. There may be a problem in the antenna system. If the antenna cabling or the antenna mast rigging position has changed since the antenna was last tuned, the antenna tuner will not be adjusted automatically. To retune the antenna tuner, press the ENTER key. If transmission is still poor, inspect the tuner, antenna and ground plane for loose connections or misplaced parts. If no loose connections are found, call your service representative for assistance.
	<ul style="list-style-type: none"> • There are no bars at the RF power bar graph. Indicates low transmitter power, which can be caused by a faulty microphone, faulty transmitter, overheating, or defective antenna system.

In case of a failure during operation, one of the following messages may appear on the display:

Message	Troubleshooting
NO CLOCK	Check whether: <ul style="list-style-type: none"> • A 30A fuse is installed in the fuse holder on the red wire of the power cable.
SYN FAIL	Perform a built-in test (BITE) for more information.
PW LATCH	Perform a built-in test (BITE) for more information.
OVER TMP	Check whether: <ul style="list-style-type: none"> • There is any fan obstruction • Perform a built-in test (BITE) for more information.
CU-LIMIT	Check whether: <ul style="list-style-type: none"> • The radio is programmed to TUNER OFF if your antenna system is not equipped with an ATU • A short circuit occurred in the antenna's coax • The ATU is in working condition.
NOT PROG <i>(This message appears if there is a failure in the DC power to the radio during RSS programming)</i>	Check whether: <ul style="list-style-type: none"> • The radio is not programmed and the baud rate is 1200 bit/sec. If necessary, program the radio parameters (from RSS).

Service

Proper repair and maintenance procedures will ensure efficient operation and long life for this product. A Motorola maintenance agreement will provide expert service to keep this and all other communication equipment in perfect operating condition. Through its maintenance and installation program, Motorola makes available the finest service to those desiring reliable, continuous communications on a contract basis.

Motorola's Customer Service Division is the largest service organization specializing in mobile communications. It includes over 900 authorized or company-owned stations. In addition, our products are serviced throughout the world by a wide network of company or authorized independent distributor service organizations. For a contract service agreement, please contact your nearest Motorola service representative, or Motorola sales representative. If you suspect a radio problem, check the following items before requesting service.

Phone line support:

Motorola Radio Support Center
3761 S. Central Avenue
Rockford, IL 61102
USA

Phone:

International: 847-725-4830
Domestic USA: 1-800-227-6772

For customers of the US Federal Market, phone line support is available at:

Motorola USFG Depot
7940 Penn Randall Place
Upper Marlboro, MD 20772
USA

Phone:

International: 301-736-4300 (Fax: 301-735-7414)
Domestic USA: 1-800-969-6680 (Fax: 800-784-4133)

Installation

General

This section describes the installation of the radio.

Inspection

Carefully inspect the radio immediately upon receipt, and notify the shipper of any damage incurred in transit.

Planning the Installation of your Radio

Before installing the radio, familiarize yourself with the installation procedure detailed.

Select the mounting location taking into account convenience of access to electrical connections and maintenance. The selected location should be clean, dry and well ventilated. Do not mount the unit in close proximity to strong electrical fields produced by brush motors and generators, welders, etc.

The antenna, antenna tuner and associated cable kits are provided separately, and these should be installed before the radio itself is installed. Follow the instructions included with the units and kits.

The radio may be placed on any sturdy, flat surface. An accessory mounting tray (included in the Mobile Mounting Kit, FLN2272) allows the radio to be mounted in any position.

No preliminary internal wiring connections are required before installing the radio.

Base Station Installation

You can use either an AC power supply or a 12 V battery as the radio power supply . (It is possible to connect a backup battery to the battery terminals on the power supply). Power Supply model F2369 for 220 V AC, 50 Hz, field programmable for 110 VAC, 60 Hz should be used for this purpose.

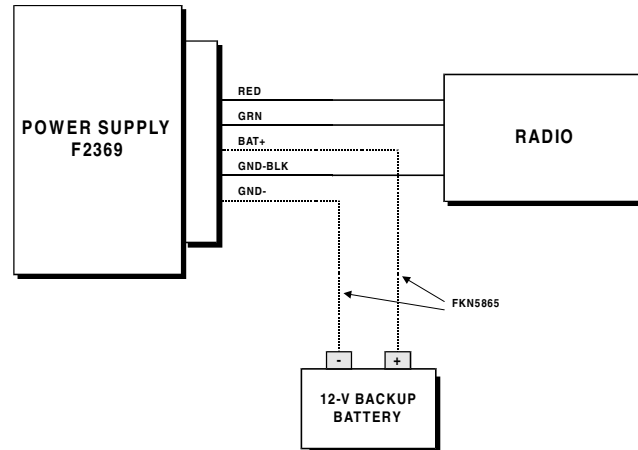

Figure 2: Power Supply

This power supply also serves as a charger for the external backup 12V battery, if connected. When AC power failure occurs, the battery functions as the main power source. When AC power is again available, the power supply charges the battery.

The cable and connector supplied with the power supply enable connecting the supply directly to DC connector J4 at the radio rear panel. (The DC Power Cable supplied with the radio is not used in this installation).

Mobile Installation

Figure 3 illustrates the installation procedure, and shows the location of the installed components inside a vehicle.

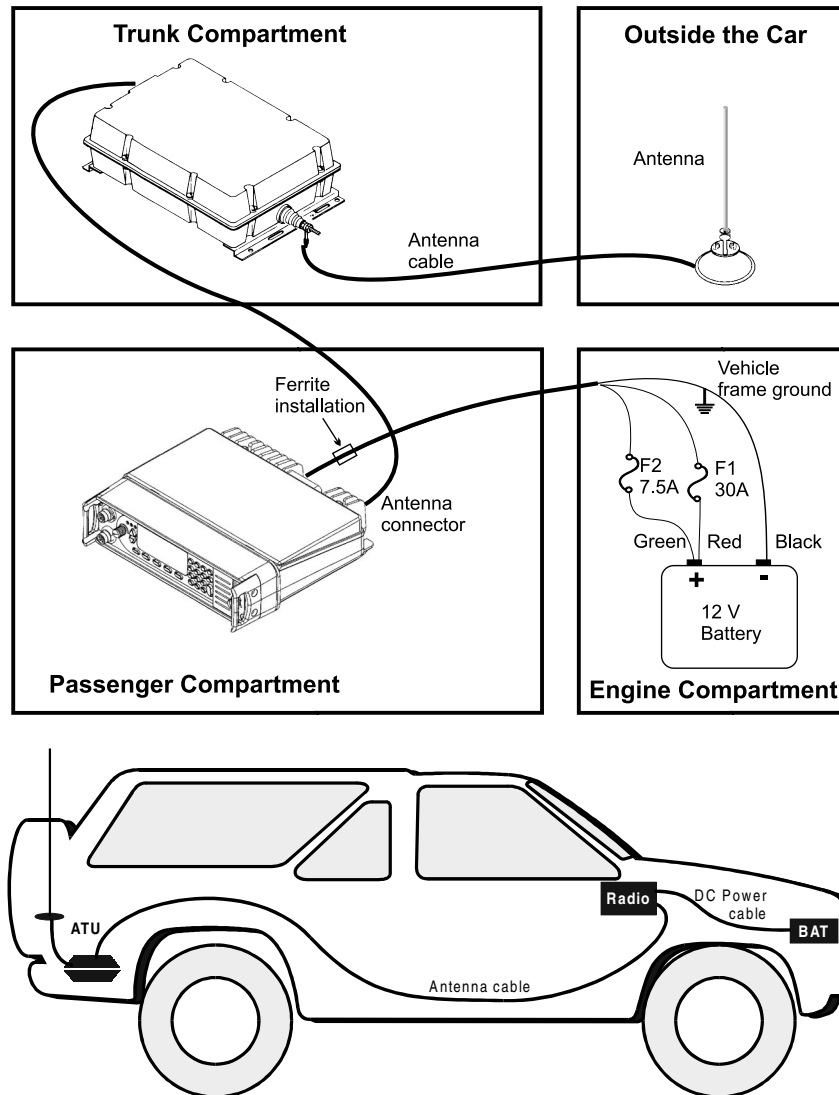

Figure 3: Front Model Installation

The radio is installed on the dashboard of the vehicle inside the passenger compartment. The other components connect to the power source, the battery, and to the antenna, which enables the radio to transmit and receive. If the battery is located in the rear section of the vehicle, the power cable extends to the battery location in the rear.

Installation Procedures

Follow these procedures to install the radio in the desired location. If the accessory mounting tray is not used, ignore the steps pertaining to it.

- Mobile Mounting Kit**
1. Mount the accessory mounting tray in the desired location. Use the tray as a template if holes must be drilled.

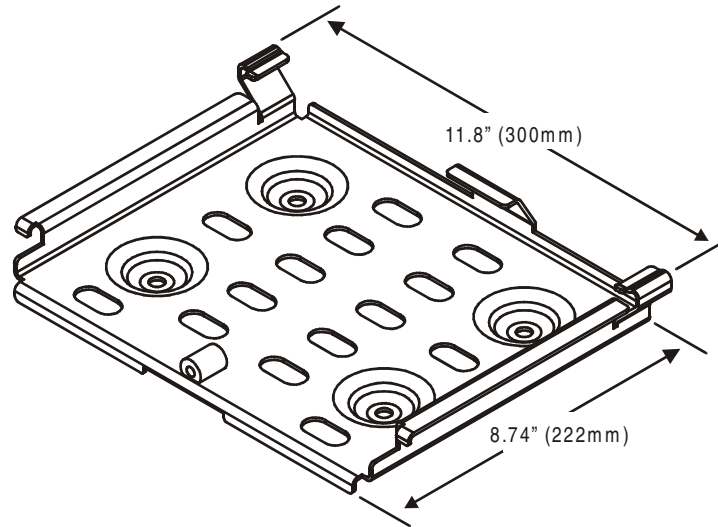

Figure 4: Accessory Mounting Tray

2. Use the four supplied screws to fasten the mounting tray bracket to the bottom of the radio housing.
3. Drill an additional hole for the grounding bolt.
4. If a mounting tray is used, slide the radio with the bracket into the tray and fasten the bracket to the tray with the supplied screw.

DC Power Connection

To connect a 12V negative-ground vehicular battery.

1. Lead the power connector on the DC Power Cable to the DC connector on the radio, but do not attach it. Lead the three heavy wires (red, green and black) to the 12V battery, threading them through the access holes as required.

The wires must be as short as possible. Cut off any excess wire.

2. Thread the red and green wires from the power connector through the two fuse holder caps; separate the fuse clips and solder or crimp them to the wires.
3. Install the 30A fuse in the fuse holder on the red wire, and the 7.5A fuse in the fuse holder on the green wire.
4. Crimp or solder the supplied lugs to the red, green, and black wires.
5. Connect the lugs on both red and green cables to the battery's positive terminal. Then connect the lug on the black wire to the battery's negative terminal.

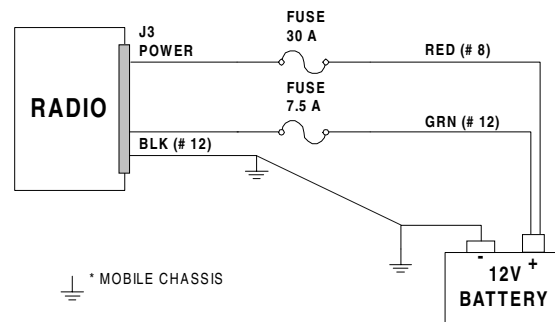

Figure 5: DC Power Connection



Note

- Connect the grounding (black wire) to the vehicle chassis, as close as possible to the radio.
- In front installation, add one ferrite (supplied with the installation radio kit) on the DC cable as close as possible to the radio.
- In trunk mount installation, add one ferrite (supplied with installation kit) on the DC cable as close as possible to the radio and one ferrite on the control cable, halfway between the control head and the radio.

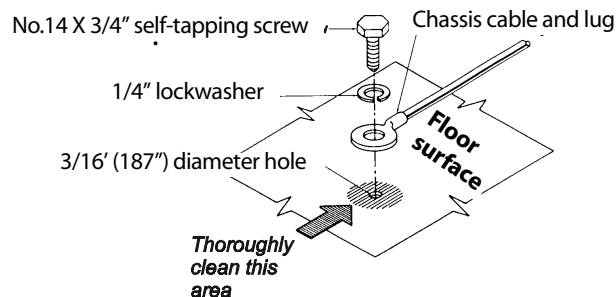

Figure 6: Wire Attachment to Chassis

Microphone Clip

The microphone cable enables placing the microphone clip in any convenient location up to five feet from the radio. To install the clip, use it as a template to drill two holes to receive self-threading sheet-metal screws. Mount the clip using the supplied screws.

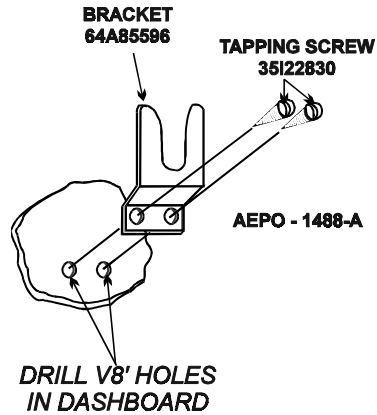

Figure 7: Microphone Clip

Final Connections



Warning

Ensure that the radio is off before making these connections.

1. Connect the power cable to DC connector J4 and connect the antenna RF cable to antenna connector J2.
If an antenna tuner is used, connect the antenna to the tuner, connect the tuner RF cable to connector J2, located on the radio rear panel.
2. If a mounting tray is used, slide the radio with the bracket into the tray and fasten the bracket to the tray with the supplied screw.
3. Use the tie straps included with the Cable Kit to tie loose cables out of the way.
4. Connect a ground lead from the GND screw on the radio rear panel to the chassis of the vehicle.



Important

Special attention should be given to locating an appropriate vehicle ground. Optimum radio performance can only be achieved with a ground connection having a very low resistance.

The vehicle frame makes the best ground, but body structural reinforcement members are also suitable for grounding purposes. The ground lead should be as short as possible.

External Speaker Installation

An external speaker can be connected to the radio. Any speaker with an impedance greater than 8Ω can be used, and is connected through the accessory connector (pin 1,3).

Operational Checks

When installation is complete, carefully check all operating functions (refer to the Operation section). In case of malfunctioning, refer to the sections on Troubleshooting and Tuning the Antenna in this manual.

Connectors

Microphone Connector J1

The microphone connector is located on the lower part of the radio front panel. Table 1 lists the functions of the microphone connector pins.

Table 1. Connector J1, Pin Connections

No.	Pin Name	Description
1	SWA+	Microphone Power
2	RXD	Serial communication
3	TXD	Serial communication
4	GND	Ground line
5	MIC AUDIO	Input audio signals generated by the microphone (600Ω impedance, 100 mV 1 KHz tone is required for full output power)
6	PTT MIC	Activates transmission by short to ground
7	MONITOR	Mutes the speaker before transmission is enabled (short momentary to ground to open speaker)
8	AUDIO OUT	Receive audio 600Ω (300 mVRMS)

Antenna Connector J2

The “N type” antenna connector is located on the rear panel of the transceiver and is used to connect the antenna.

Accessory Connector J3

Accessory connector J3 is a 25-pin D-type plug located on the rear panel of the radio. It is used with external accessories such as a modem, a linear amplifier, a phone patch, etc.

If you wish to connect Morse key and headphones using their standard connectors, use interface cable FKN4403.

To connect up to four devices simultaneously, use FLN2271.

Table 2 lists the pin connections of Connector J3.

Table 2. Connector J3, Pin Connections

No.	Pin Name	Description
1	SPKR- (Do not connect to GND)	Differential output to the external 8Ω, 5W speaker
2	OPTION	Option dependent
3	SPKR+	Differential output to the external 8Ω, 5W speaker
4	RX AUDIO+	Differential output received audio signals (0 dBm; 600Ω; not controlled by volume)
5	RX AUDIO- (Do not connect to GND)	Differential output received audio signals (0 dBm; 600Ω; not controlled by volume)
6	TX AUDIO+	Differential input received audio signals (600Ω input impedance, 0 dBm is required for full power)
7	TX AUDIO- (Do not connect to GND)	Differential input received audio signals (600Ω input impedance, 0 dBm required for full power)
8	PTT IN VOICE	Xmit command (by short to ground) for voice signals
9	PTT IN DATA	Xmit command (by short to ground) for data signals
10	PTT IN CW	Xmit command (by short to ground) for CW (Morse)
11	SWA+	13.8V (nominal) current limited
12	KW C C	KW option channel change
13	KW ON/OFF	KW option power ON/OFF
14	AGC FAST/SLOW	AGC fast or slow release
15	RXD	Point to point communication line to HOST/HLC
16	TXD	Point to point communication line to HOST/HLC
17	RESET	External RESET
18	GND	Ground
19	KW PTT	KW PTT
20	EXT ALARM	External Alarm Operation (open collector –pulled to ground when external alarm is activated)
21	VPP	Flash programming voltage
22	KW ALC	KW ALC
23	SQ GATE	Squelch Indication
24	FAN ON/OFF	FAN ON/OFF
25	KW TUNE	KW tune

DC Connector J4

DC connector J4 is mounted on the rear panel of the radio. It is used to feed the radio with the required power from an AC to 13.8V power supply or from the battery. The following table lists the function of the DC connector lines.

Table 3. Connector J4, Pin Connections

No.	Pin Name	Description
1	TX Power	Used to deliver high currents (up to 28 Amp) to the radio, mainly for the transmitter circuitry
2	Ground	Used as return line for receive and transmit lines
3	RX Power	Used to deliver relatively low currents (up to 3 Amp) to the radio, mainly for the receiver circuitry

Reduction of Vehicular Noise

Most vehicles are subject to several noise sources which greatly disturb a received signal. The most noisy sources are the high voltage ignition sparks that are produced at the vehicle's plugs. Alternator activity also generates significant noise.

By following these insulation guidelines, and if necessary by adding certain damping components, it is usually possible to reduce vehicular noise:

1. Keep your antenna tuner and antenna as far as possible from the engine compartment.
2. Connect the primary power lead of the radio directly to the battery instead of the starter relay. The battery acts as a large capacitor (about one farad for 50 A-H capacity batteries) by passing the noise to ground.
3. If necessary, connect 0.01 - 0.1 mF capacitors across the primary leads of the coil and across the alternator output.
4. Keep your DC and RF cables as short as possible.
5. If your vehicle does not have a resistive ignition wire, it is recommended to replace it with such a wire.
6. The MOTOROLA RF noise reduction kit for alternator equipped vehicles (TLN8845) includes some useful accessories for noise reduction, including a resistive ignition coil suppressor cable. In severe noise conditions, you may find this kit helpful.

List of Procedures

To turn the radio on	13
To Transmit	14
To Receive Calls	14
To choose a channel	16
To transmit in Channel mode	16
To enter frequency mode	18
To change the current frequency/frequencies	19
To store a frequency in a channel	22
To use scan mode	23
To select scan mode options	24
To run BITE	26
To lock the radio	27
To unlock the radio	27
To change the password	28
To change the display brightness level	29
To change the radio language	30
To enter Radio Programming mode	31
To copy channel parameters	33
To erase a channel	34
To set the channel's transmission power level	34
To set a channel's frequency	35
To set the channel band type	36
To set the operating mode	36
To set the AGC speed	37
To set the channel bandwidth	38
To set the baud rate	39
To set the data power level	40
To enable/disable the Microphone Side Tone (MST)	40
To enable/disable the Accessory Side Tone (AST)	41
To enable/disable the PTT Release Beep (PTBP)	41
To enable/disable the Keyboard Beep (KBBP)	42
To set the tone level	42
To set the display time-out	43
To enable/disable the attenuator	43
To select a CW frequency filter	44
To enable/disable the receive level bar	44
To select the Dimming or Fixed display modes	45
To set the tuner on or off	46
To set the amplifier option on or off	46
To connect a 12V negative-ground vehicular battery.	57

