

INSTRUCTION MANUAL

FT - 250

SOMMERKAMP ELECTRONICS GMBH

GERMANY

FT-200/250 BLOCK DIAGRAM

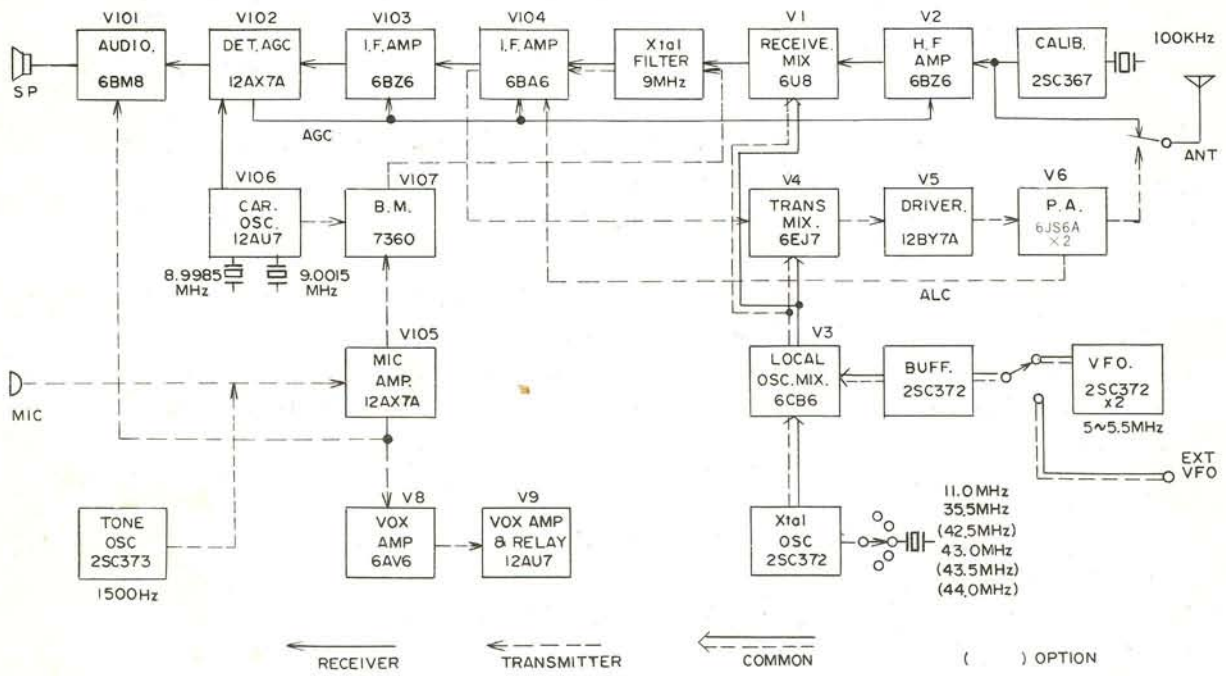

FT-200/250 SSB TRANSCEIVER

The FT200/250 Transceiver, for HF amateur bands 80 through 10 meters, is a precision built high performance transceiver providing SSB (USB and LSB selectable), CW and AM modes of operation, with a single-tone power of 240W (approx. 300W speech peak input).

High stability is obtained by use of a well designed heterodyne VFO, and the specially designed 9 MC crystal filter ensures good voice quality.

Its compact size, light weight, and attached carrying handle make it very suitable and convenient for both home, portable, and mobile use.

Other features include VOX, 100 kc calibrator, ± 5 kc receiver offset (clarifier) tuning and easy connection for use of a Linear Amplifier.

FP-200/250 matching AC power supply with built-in speaker is especially designed for use with the Transceiver, A 12V DC supply; the DC-200/250 provides for mobile or field use.

GENERAL SPECIFICATIONS

Modes	SSB (USB-LSB), CW, AM
Input power	240W
Frequency range	3.5-4; 7-7.5; 14-14.5; 21-21.5; 28.5-29. (crystals optionally available for ranges 28-28.5; 29-29.5; 29.5-30 MC)
Antenna impedance	50-100 ohms
Frequency stability	After warm-up, within 100 cps/ every 30 minutes
Carrier suppression	-40 dB
Sideband suppression	-50 dB at 1000 cps
Third order intermodulation products	-30 dB (P.E.P.)
A.F. bandwidth	300-2700 cps
Receiver sensitivity	0.5 uV input S/N 10 dB
Selectivity	2.4 kc (-6 dB), 4 kc (-60 dB)
I.F. interference ratio	50 dB
Image ratio	50 dB
Audio output	1W at 10% distortion
Audio output impedance	8 ohms
Power supply	AC or DC with separate power supplies
Tubes & semiconductors	16 tubes, 15 diodes, 7 transistors
Dimensions	13 $\frac{1}{4}$ " wide, 5 $\frac{1}{2}$ " high, 11" deep
Weight	17.5 lbs. (8kg)

FP-200/250 SPECIFICATIONS

Semiconductors	9 diodes
Dimensions	8" wide, 5½" high, 11" deep
Weight	Approx. 22 lbs. (10kg)
Speaker (built-in)	5" x 3", 8 ohms
Supply voltage	100V/110V/117V/200V/220V/234V 50-60 cps

DC-200/250 SPECIFICATIONS

Matching DC power supply	
Semiconductors	4 transistors, 9 diodes
Dimensions	8" wide, 2¾" high, 8 ⁷ / ₈ " deep
Weight	Approx. 6.6 lbs. (3kg)
Power source	DC-12V, 12.5A (receive), 15A (transmit), 27A (transmit 100W peak)

CIRCUIT DESCRIPTION

It can be seen from the block diagram that many sections are common for both receiving and transmitting. For an easier understanding of the operation, the receiving and transmitting sections will be described separately.

Receiving Section

Signal from ANT terminal passes through antenna RX/TX relay to ANT input tuned circuit to grid 1 of RF amplifier tube V2, 6BZ6. Signal is amplified and through the next tuned circuit on the grid of receiver mixer tube V1, 6U8, pentode section. Local oscillator signal is applied to cathode of this mixer and the I.F. signal appears at mixer plate. The I.F. signal then passes through the 9 MC crystal filter to the two stage amplifier V104, 6BA6, V103, 6BZ6 and thence to V102A, ½12AX7 power grid detector. This detector acts as a product detector, with BFO signal applied to its cathode, when receiving CW and SSB. V102B, ½12AX7 functions as an anode detection type amplifier of AGC. With no signal applied, plate current is zero with plate voltage zero. When signal is applied, plate current develops, resulting in a negative plate voltage which is applied through diode D103 to AGC line. Circuit provides suitable AGC characteristics of fast attack, slow decay for SSB and CW. Internal resistance of diode is low in forward direction and high in reverse direction. AGC voltage is applied to RF and IF stages so that a wide range of signal levels can be handled. Detector output is fed to silicon diodes D101, D102, ANL, then via AF gain control, through 6BM8 AF output tube to speaker or headphones.

Transmitting Section

Output of carrier oscillator V106, 12AU7 is injected to first grid of V107, 7360 balanced modulator and audio signal from mic. Amp. to modulating grid of BM. Suppressed carrier

DSB is developed at plate of BM. This signal then passes through the crystal filter XF101, which eliminates one sideband, thus resulting in a SSB signal, 9 MC.

For AM transmission (sideband with carrier insertion) the BM becomes unbalanced because of switching circuitry, permitting carrier to pass through, and also carrier frequency is shifted by means of a varicap diode circuit so that carrier passes freely through filter pass-band. Amount of carrier insertion level is adjustable by AM carrier control VR8.

For CW transmission, audio is disabled, and similarly as for AM, the BM is unbalanced and carrier frequency shifted to allow full carrier to pass through filter.

In the TUNE condition, a 1500 cps signal from the audio tone oscillator TR503 is applied to the BM. This provides a convenient tuning signal near filter center frequency. Level of signal is controlled by mic. gain control.

The 9 MC signal, after passing through the filter, is amplified by IF amplifier tube V104, 6BA6, thence to grid of mixer tube V4, 6EJ7, together with local oscillator signal. The resultant difference between these two frequencies appears at plate tuned circuit of mixer and is the transmitting ham band output signal frequency. On 14 MC band, additive mixing is used.

This signal is amplified by V5, 12BY7 tuned driver and finally to power amplifier tubes V6/V7, 2 x 6JS6A, and antenna. Power amplifier V6/V7 operates in class AB2 for maximum power output.

The AC audio component of PA grid current, when overdriven by signal peaks, is rectified by diodes D4/D5 to provide an ALC (Automatic Level Control) voltage to the IF amp. stage thus reducing its gain and maintaining low distortion.

The PA Pi network plate circuit provides attenuation to the higher order harmonics and enables easy, flexible adjustment of impedance matching to antenna feedline.

On phone, PTT and VOX control is available. On VOX, a sample of signal from microphone is applied to grid of V8 and then to V9A, rectified by diode D2, SH-1, producing a positive bias on the grid of V9B relay tube, causing plate current to flow and relay to actuate. On CW, "straight" or "break-in" keying methods are available. Break-in is produced by keying audio oscillator tone applied to VOX amp. as well as transmitter bias line. The relay switches bias on V107, V4, V5, V6 and V7.

Tone signal also can be heard from speaker while keying, thus providing sidetone monitoring.

OSCILLATOR CIRCUITS

In the FT-200/250 crystal oscillators are used for carrier generation and the bandswitched heterodyne oscillator, together with a self-controlled oscillator for VFO, which is at a frequency low enough to obtain good stability. Other oscillators included are 100 kc crystal calibrator and audio tone oscillator. An external VFO model FV-200 is available to provide additional operational flexibility and split frequency operation.

1. **Carrier crystal oscillator**

V106, 12AU7 double triode with crystals 8998.5 kc and 9001.5 kc, one in each triode section. With sideband selector switch at NORMAL, carrier crystal 8998.5 is operative for 7 and 14 MC band and 9001.5 for 3.5, 21 and 28 MC. When the selector switch is in REVERSE position, then the carrier crystal oscillator sections are changed.

Carrier oscillator operates like the BFO when in receive mode.

On AM & CW, crystal 9001.5 is used and its frequency is lowered 200 cps by diode switch D104, 1S1007, bringing carrier into filter passband.

2. **Bandswitched heterodyne oscillator**

This is a crystal oscillator using silicon type 2SC372 transistor, and it is operative on bands 7, 21 and 28 MC. 10 M band crystal is included for 28.5–29 MC, and positions are available for other three optional ranges for full coverage of 10 M.

3. **VFO self-oscillator**

The VFO is a transistorized Colpitts circuit with 2SC372 oscillator and 2SC372 buffer. It has linear tuning over the range 5 – 5.5 MC. A passband filter circuit at output is tuned to pass the 5 – 5.5 MC range. Varicap diode D401, 1S145 permits receiver off-set tuning control ± 5 kc on receiving.

4. **Crystal calibrator oscillator**

Transistor oscillator 2SC367 with 100 kc crystal, and diode type 1S1007 harmonic generator provides accurate check points every 100 kc on main dial.

5. **AF oscillator**

The phase shift type with 2SC372 transistor, generating audio tone signal at 1500 cps, supplies transmitter tune-up signal and CW sidetone monitoring. This oscillator also actuates VOX relays for semi-automatic break-in CW operation.

LOCAL OSCILLATOR MIXER CIRCUIT

VFO output is applied to grid 1 of V3, 6CB6 mixer and heterodyne oscillator output to cathode. Resultant beat frequency is selected in plate tuned circuit.

METER CIRCUIT

Meter is 1 mA movement, and it is connected to 2nd IF stage to read change in cathode voltage of V103, resulting from variations of AGC voltage, to indicate receiver "S" units.

Meter is automatically switched by relay RL101, on transmitting, to indicate relative power output (PO) PA cathode current (IC) and ALC voltage. Meter scale is fully calibrated, and transmitter metering functions PO, IC and ALC, are selected by panel mounted slide switch.

VOLTAGE REGULATOR CIRCUIT

The voltage regulator circuit, mounted on a print board, provides 9 volts for all transistor oscillators. Two transistors are used, 2SC372 and 2SC367, together with two zener diodes, 1S331 and 1S336, and voltage level can be set by adjustment of variable resistor VR501.

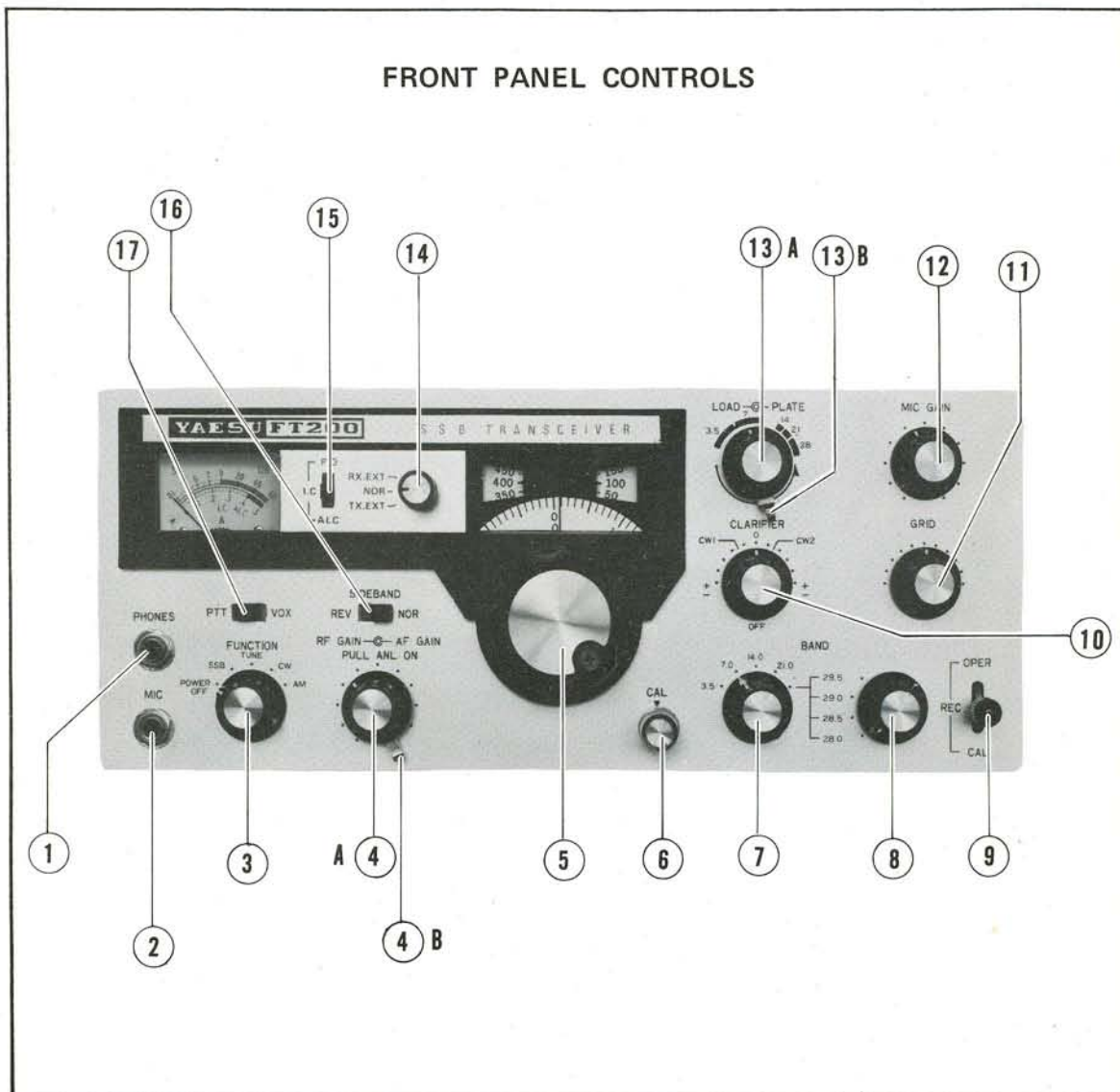

Meter is automatically switched by relay RL101, on transmitting, to indicate relative power output (PO) PA cathode current (IC) and ALC voltage. Meter scale is fully calibrated, and transmitter metering functions PO, IC and ALC, are selected by panel mounted slide switch.

VOLTAGE REGULATOR CIRCUIT

The voltage regulator circuit, mounted on a print board, provides 9 volts for all transistor oscillators. Two transistors are used, 2SC372 and 2SC367, together with two zener diodes, 1S331 and 1S336, and voltage level can be set by adjustment of variable resistor VR501.

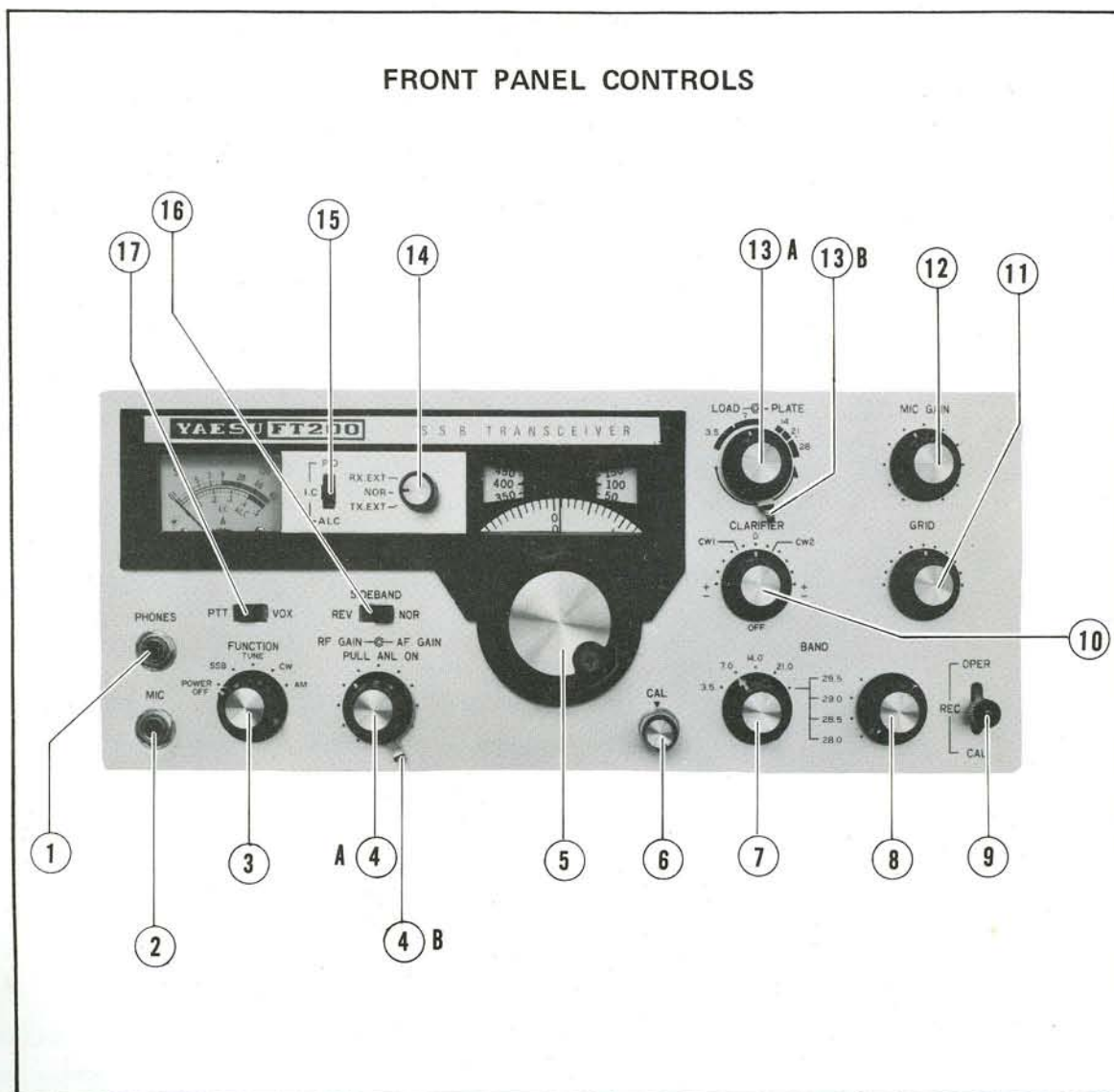

- | | | |
|--------|---------------------------|---|
| 1. | Phones | Headphone socket. Impedance 600 ohms.
When plug is inserted into socket, speaker is automatically disconnected. |
| 2. | Mic. | Microphone socket. Standard ¼" 3 contact T.R.S. type. High impedance. Tip relay control. Ring microphone audio. Sleeve ground. |
| 3. | Function | Function switch.
OFF AC power removed from power supply.
SSB Selects SSB operation.
TUNE Places TX in tune-up condition.
CW Selects CW operation.
AM Selects AM operation. |
| 4A. | AF Gain, Pull-ANL-On | Knob |
| 4B. | RF Gain | Level control |
| 5. | VFO | Control knob and vernier drive.
One revolution of knob covers approx. 15 kc. Upper windows give 50 kc points with 0-500 markings. The vernier scale is marked in 1 kc steps, 0-100. |
| 6. | Cal | This is a locking knob used to set dial calibration in conjunction with the 100 kc calibrator. With transceiver in receiving condition, the vernier dial is turned to "O" and locked by a half turn of the CAL locking knob. 100 kc calibrator is switched on with control No. 9. Then the VFO knob is rotated to a 100 kc point so that calibrator beat note is heard. It is then adjusted for zero beat. Locking knob is then released. |
| 7 & 8. | Band | Bandswitch, marked for bands in MC. Red colors indicate that red scale is to be used on VFO dial. The various 28 MC ranges are selected by knob No. 8 when No. 7 is at its full clockwise position. |
| 9. | Oper-Rec-Cal | Lever switch. Selects functions of calibrator receiving and transmitter operation. |
| 10. | (Receiver off-set-tuning) | Clarifier adjustment. It provides ±5 kc variation of receiver tuning ("off-set-tuning"). When switched to OFF, the receiving and transmitting frequencies are the same. |

- | | | |
|------|------------|---|
| 11. | Grid | Controls RF tuning of receiver and drive tuning of transmitter. |
| 12. | Mic. Gain | Controls microphone amp. level. On TUNE it becomes a tuning level control. |
| 13A. | Plate | Knob. Adjusts PA plate tuning. |
| 13B. | Loading | Lever. Adjusts PA plate loading. |
| 14. | VFO Select | For switching from internal to external VFO. NOR is transceive on internal VFO. RX EXT is receive on external VFO, transmit on internal VFO. TX EXT is transmit on external VFO, receive on internal VFO. |
| 15. | PO-IC-ALC | Meter selector switch. Switches meter functions for transmitter metering. |
| 16. | Sideband | Sideband selector slide switch. In the NORMAL position, LSB is produced on 3.5 and 7 MC, and USB on 14, 21 and 28 MC. In the REV position, USB is produced on 3.5 and 7 MC and LSB on 14, 21 and 28 MC. |
| 17. | PTT-VOX | Slide switch. Selects PTT or VOX functions. |

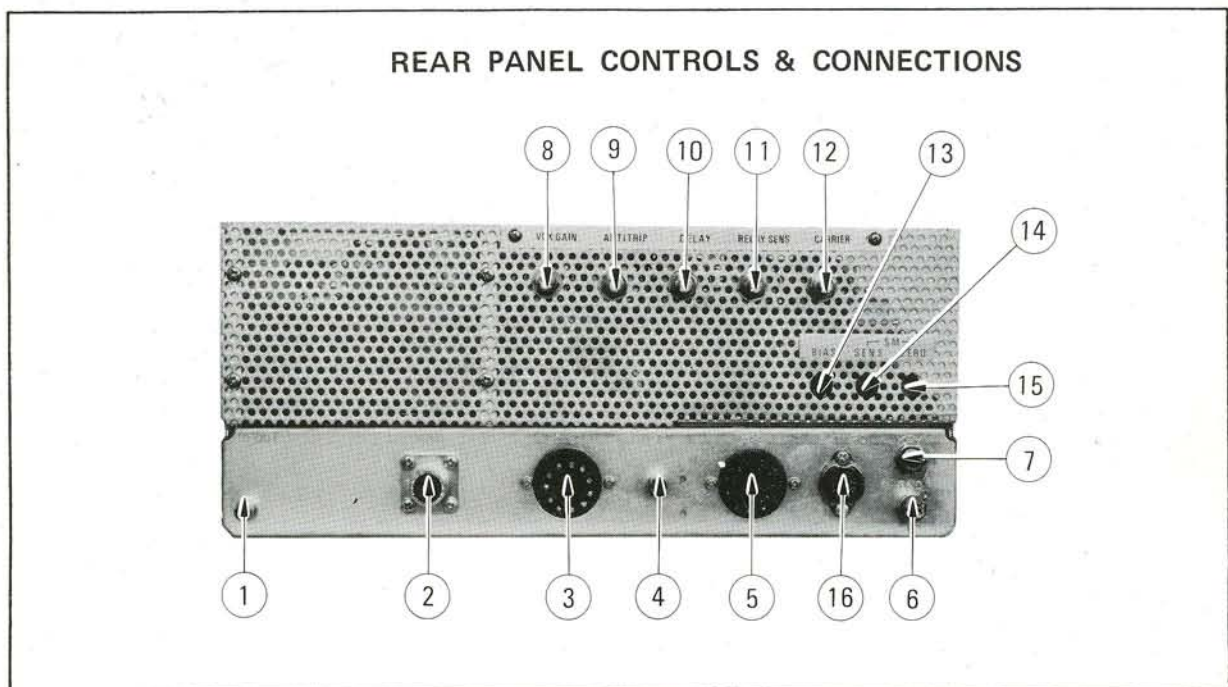

- | | | |
|-----|------------------------|---|
| 1. | R.F. Out | Provides low level R.F. drive for VHF transverter. |
| 2. | ANT | Antenna coax socket. |
| 3. | Power Supply Connector | (see P. 15 for details) |
| 4. | Speaker Socket | 8 ohms |
| 5. | Accessory Socket | (see P. 15 for details) |
| 6. | Earth Terminal | |
| 7. | Key Socket | |
| 8. | VOX Gain | Adjusts VOX sensitivity. |
| 9. | Anti-Trip | Adjusts VOX anti-trip level. |
| 10. | Delay | Adjusts "hold-in" time of VOX |
| 11. | Relay Sens | Adjusts operating level of VOX relay. |
| 12. | Carrier | Adjusts level of re-inserted carrier for AM/CW operation. |
| 13. | Bias | Adjusts bias on PA tubes. |
| 14. | Meter Sens | S-meter sensitivity control. |
| 15. | Meter Zero | Adjusts S-meter zero setting. |
| 16. | Aux | External VFO socket. |

OPERATION

Step 1 of Operation

FUNCTION	POWER OFF
RF-AF-GAIN	RF maximum clockwise AF about half on
BAND	Set to desired band
CLARIFIER (Receiver offset tuning)	OFF
PLATE	Set to desired band
LOADING	Minimum loading
METER SWITCH	IC
OPER-REC	REC
SIDEBAND	NORMAL
MIC GAIN	OFF
CAL	In released position
VFO SELECT	NOR

1. Set controls as shown below

First check that all cable connections are correct and that antenna of correct frequency and impedance within the range of the Pi-net (50 100 ohms) (coax output) is connected to the transceiver. AC power plug should not be connected until all preliminary checks are carried out. Aux plug provided should be inserted in auxiliary VFO socket if external VFO, FV-200 is not used. Turn power on with function switch to SSB position. Panel lamps should light and S-meter needle will show a full scale reading. Then slowly return to "O" as set warms up. This can be accepted as an indication that the set is then ready for operation. Tune GRID for noise peak.

Adjust main tuning dial for signal.

Peak GRID for maximum S-meter reading.

Careful tuning is necessary to obtain correct tone of SSB signal. If the received signal is on opposite sideband, then move REV-NOR switch to REV.

A beat note indicates that an AM signal is being received. In this event turn function switch to AM. Adjust AF gain for comfortable listening volume. Sometimes a slight reduction of RF gain will obtain clearer reception.

2. Transmitter tuning

Transmitter should be tuned into a 50 ohm dummy load, but it may be tuned on an antenna provided that the band is clear; and no interference will result to other stations. Take care to ensure that transmitter frequency is adjusted within frequency limits of band in use.

DO NOT OPERATE TRANSMITTER with no load connected; otherwise PA tubes could be damaged.

Disconnect microphone, meter switch to IC, MIC gain off, control switch to PTT, function SSB. Then when REC-OPER switch is moved to OPER, and using power supply of 600V HT, the meter will indicate the PA resting current.

This should be 60 MA; if not, then adjust bias control at rear.

Now turn FUNCTION switch to TUNE, advance MIC gain to obtain a small increase in meter reading, up to about 100 MA, and adjust GRID for maximum IC. Note that the setting for the GRID control will be virtually the same as was found for receiving. Reduce MIC gain if IC rises abnormally high.

Adjust PLATE for minimum dip in IC. Switch meter to P.O. and adjust PLATE and LOAD controls in turn for maximum RF power out. IC should dip to about 70/80% of the off-tune current for best loading condition. At maximum input the IC is about 350 MA, but refrain from using this high current for longer than a few seconds; therefore make all adjustments quickly. During tune-up, switch REC-OPER switch off periodically to reduce the time transmitter is on with high IC.

While it is permissible to tune transmitter, using meter on P.O. position, it is recommended that an external SWR meter be connected between antenna socket and feedline, not only to check matching of transceiver to antenna feedline and observation of transmitter RF output, but so that transceiver meter can be left in IC position for constant monitoring of PA current. Any abnormal rise-in IC can then be noted and quickly corrected.

3. Transmission

SSB

Insert microphone plug of PTT microphone. (If microphone does not have a PTT switch, then short out PTT terminals on plug and control transceiver with REC-OPER panel switch.) Turn REC-OPER switch to OPER.

While speaking, adjust MIC gain for correct IC meter "kick-up". Switch meter to ALC and check that needle does not rise above limit of green section of scale on speech peaks. Indicated IC will be about half the tuning IC, i.e. about 150 MA on peaks. Attempting to obtain more power by "forcing" or overdriving the transmitter will obtain only an insignificant increase in strength and will result in a distorted signal with possible radiation of spurious emissions. Keep MIC gain down, speak fairly close to microphone to reduce background noise pick up, and try to maintain an even level of speech.

Do not have VOX gain control set too high; otherwise operation will be unstable. If anti-trip control is advanced too far, then VOX will lose sensitivity. Set anti-trip to a position where it is just preventing speaker noise from "triggering" the VOX. If VOX fails to function, check that microphone has sufficient sensitivity and if OK then replace V9 and re-adjust relay sensitivity control.

CW

Remove microphone plug. For CW operation on 7 and 14 MC, place Sideband switch in REV position; otherwise drive will be low. The varicap diode is connected to only one carrier crystal (9001.5 kc) and this diode's operation shifts carrier within filter passband. Use clarifier control only for changing or tuning-in the received signal, e.g. small readjustment to return a drifting signal or adjusting pitch of received signal. Once main VFO control has been set to frequency of desired contact, it should not normally be altered; otherwise each station will be retuning and moving through the band.

For break-in operation set control switch to VOX and adjust VOX delay, etc. to suit requirements. Do not hold key down for long periods; otherwise PA tubes can be damaged. Use CW IC at 250 MA. MIC gain will control sidetone level.

AM

Place function switch on AM, MIC gain to "O". Set AM carrier control at rear to give IC of 150 MA. Adjust MIC gain so that speech deflects meter a further 5-10 MA. As for CW, set control to REV for 7 and 14 MC bands. PTT or VOX can be used in the same way as for SSB operation.

ALIGNMENT

The FT-200/250 has been correctly aligned at factory and, under normal circumstances, realignment should not be necessary except after a long period of use. The alignment of such modern, sophisticated equipment as this requires the correct test instruments and should not be attempted unless one has had a reasonable amount of experience in such alignment techniques.

CAUTION – Before any work is attempted, remember that high voltages are employed in this equipment, so – TAKE CARE!

1. Equipment required

VTVM with RF probe
RF standard signal generator
AF signal generator
Circuit tester
Frequency meter
Dummy load 50 ohms
Suitable alignment tools

2. Voltage and resistance measurement

Refer to tables on Page 17

Note that measurement figures obtained could vary slightly from those shown, particularly if a low resistance testing meter is used. Always turn off power, remove AC plug, and completely discharge all filter condensers before taking measurements.

3. Voltage regulator

The V.R. is mounted on a printed circuit board and supplies a regulated output of 9V, adjustable by the pre-set type miniature pot VR501. If output cannot be brought up to the 9V level it may be due to a fault in components on the printed circuit board, e.g. transistors or zener diode, or supply voltage below 11V.

4. VFO alignment

On the red scale, "O" = 5 MC and "500" = 5.5 MC.

Switch off crystal heterodyne oscillator by placing bandswitch on 3.5 or 14 MC band. (Receiver offset tuning) OFF.

Use frequency meter for alignment, although this can be done, with care, if beats are heard every 100 kc using the crystal calibrator.

Coarse alignment is by adjustment of trimmer TC401.

The piston type trimmer TC402 is for adjustment of temperature compensation. If turned clockwise, then compensation becomes greater. If TC402 is adjusted, then TC401 must be re-adjusted to maintain calibration.

For precise adjustment of dial linearity, careful adjustment (by bending) of end rotor plates of main tuning condenser is necessary.

VFO injection to grid 1 of V3, 6CB6 should be 0.5V or more over full VFO range, measured with VTVM and RF probe. To obtain same frequency of clarifier at "O" as at "OFF", adjust VR7.

5. Heterodyne crystal oscillator

Apply RF probe to Pin 2 of V3, and with bandswitch at 28.5, adjust L202 for maximum meter reading.

On 21 MC band adjust TC202.

On 7 MC band adjust TC201

If optional 10 meter range crystals are added, use type HC18U crystals with wire leads soldered into marked positions on heterodyne oscillator print board.

Adjust appropriate trimmer condensers for 10 meter crystals.

6. Calibrator 100 kc

Adjust frequency with TC301 by checking against WWV, with aid of separate receiver.

7. Pre-mixer (VFO mixer)

This is V3, with output plate tuned circuit to select resultant beat of VFO and heterodyne oscillator (or VFO frequency in case of 3.5 and 14 MC bands).

This alignment should be carefully done as other frequencies can appear at output, VFO, etc. This alignment is explained in transmitter alignment section. Refer to chart, below, for correct output frequencies.

Band	Mixed Frequency
3.5	5 – 5.5 MHz
7.0	16 – 16.5 MHz
14.0	5 – 5.5 MHz
21.0	30 – 30.5 MHz
28.0	37.0 – 37.5 MHz
28.5	37.5 – 38 MHz
29.0	38 – 38.5 MHz
29.5	38.5 – 39 MHz

RECEIVER ALIGNMENT

1. Audio output stage

Connect audio generator with 1000 cps output of 0.1V level to moving arm terminal of AF gain control, and with control at maximum volume, an output of 1 watt should be obtained from the 6BM8, V101.

2. AGC

Function switch to AM, RF gain maximum, then S-meter should read "O" with antenna socket shorted. Set VR102 (AGC adjust) so that it is at a point just before S-meter needle commences to rise above "O". Now adjust meter sensitivity control so that, with S.G. 50 uV signal to antenna socket, meter will read S9. Open circuit output

of S.G. will be 100 uV, dropping to 50 uV when S.G. is connected to antenna socket, because of loading effect of receiver. Now set function switch to SSB, short out antenna socket, and meter should read "O"; but if not, then adjust the compensation capacitance (C165) between pin 2 and pin 8 of V102 to make meter read minimum deflection.

3. I.F. amplifier

Connect signal generator at 9,000 kc and adjust tuning for maximum S-meter reading at center of filter passband by observing S-meter at same time as tuning S.G. frequency. Now adjust L101, L102, L103, L104 for maximum meter reading.

4. Receiver mixer

This is V1 6U8 (alternative types 6EA8, 6GH8). Connect RF probe to pin 8, cathode of triode section, and adjust grid tuning. Oscillator injection should read greater than 0.5V on every band. Adjust trap coil L22 for minimum beat at 21.3 MC. This adjustment should occur within one turn of the core slug. L1 is trap coil for 3.5 and 14 MC bands and should be adjusted so that no oscillation occurs in these bands. Use a plastic alignment tool so that no damage will result to the internal hexagon type slugs.

5. RF amplifier

Connect S.G. to antenna. On 3.5 MC band set VFO to "O" on black scale and GRID to second point up from its counterclockwise position. Apply 3500 kc signal and adjust L7 and L12 for maximum S-meter reading. Use plastic alignment tool. 7 MC band, VFO to "O" on red scale, GRID at same point as for 3.5 MC, S.G. at 7000 kc. Adjust TC1 and TC2 for maximum.

14 MC band, VFO to 250, GRID at center position, S.G. at 14250 kc. Adjust L10 and L15 for maximum.

21 MC band, VFO to 250, GRID at center, S.G. at 21250 kc. Adjust L9 and L14 for maximum.

28.5 MC band, VFO to 500, GRID at center, S.G. at 29,000 kc. Adjust L3, L8 and L13 for maximum.

On 7 MC band, VFO to 500, apply 9 MC signal of sufficient level to give an S-meter reading; then adjust L2 for minimum dip in S-meter reading.

TRANSMITTER ALIGNMENT

The transmitter uses many common receiver circuits; therefore it is necessary to first correctly align the receiver section. A 50–75 ohms dummy load must be used on the transmitter during transmitter alignment. Take care to avoid touching H.V. points!

1. Balanced modulator

Function switch to TUNE, meter to P.O., tune transmitter for maximum reading. (Keep IC down by use of MIC gain).

Now function to SSB, MIC gain to zero, and adjust VR106 for minimum reading. For most sensitive indication, connect RF probe to dummy load, or use another receiver and observe its S-meter reading.

Then switch to opposite sideband position, and readjust VR106. Repeat several times for best result. If there is a marked difference between the two positions, then adjustment of carrier oscillator or crystal filter may be required.

2. Crystal filter

The filter is aligned once in receiver alignment, but further alignment in this section (transmitting) is necessary.

At the TUNE position adjust L103, L104 and L105 for maximum output. Keep drive reduced to a fairly low level for the most accurate determination of the maximum peak. In order to examine filter characteristics, set function to SSB and connect an A.F. generator to MIC jack, then take a curve of the A.F. response (in effect, the filter passband), by plotting between 300–2500 cps. If output level changes no more than 3 dB, then it is OK. Repeat on reverse sideband. If the two curves do not match, then a slight adjustment of each carrier crystal frequency is necessary to bring the two curves together in their frequency limits. If carrier is too close to 9000 kc filter center frequency, then high audio frequencies will be attenuated. If carrier is too far removed, then low frequencies will be attenuated. Carrier frequency adjustment is by TC101 and TC102.

3. Driver stage

Set up transmitter on TUNE, but keep level down to safe limit by adjustment of MIC gain control; then adjust driver coils and trimmer condensers for peak in output, as in receiver section alignment.

4. FINAL AMPLIFIER NEUTRALIZATION

When replacing the final amplifier tubes, it may be necessary to reset the bias to give correct idle current and check neutralization. Using the procedure outlined below will guarantee maximum output and long tube life.

CAUTION

HIGH VOLTAGES ARE PRESENT ON UNDERSIDE OF CHASSIS AND INSIDE OF FINAL COMPARTMENT. USE GREAT CARE WHILE MAKING ADJUSTMENTS WITH WIRING EXPOSED.

- (1) Connect a dummy load to antenna, and set meter to IC.
- (2) Locate TC-3 the neutralization variable capacitor shaft in the final amplifier compartment.
- (3) Check final amplifier idle current in USB or LSB position and adjust as described before.
- (4) Tune up the transceiver at 21.5 MHz, with MODE switch at AM position, and advance CARRIER potentiometer ⑫ or the rear panel until meter IC reads 150 MA.

(5) Rotate PLATE tuning control and observe dip as indicated on the meter. If the dip is not prominent, reduce loading control slightly for better indication. As the PLATE control is rotated the meter should rise equally and smoothly on either side of maximum dip indication.

(6) Determine which side of the dip rises abruptly. Set PLATE control slightly to this side of dip keeping the meter reading below 150 MA.

(7) Using no metallic tuning wand, rotate neutralization capacitor shaft very slightly in the direction which reduces the current shown on the meter. Repeat steps 6 and 7 until the meter indicates a smooth and equal rise on either side of the maximum dip point.

The final compartment cover must be in place to supply the RF shielding required during the neutralization procedure.

IMPORTANT:

Heater voltage to final tubes 6JS6A is supplied through a jumper wire between pin 1 and 2 of accessory plug, so the accessory plug must be placed in the accessory socket to provide this heater voltage.

Auxiliary VFO plug provided must be placed in the auxiliary VFO socket when external VFO, FV-200 is not used.

**Plug connection
ACCESSORY SOCKET CONNECTIONS**

- | | |
|-----------------|---|
| 1. 6JS6A heater | 8. Ground |
| 2. 12.6V heater | 9. Relay close on transmit
—use to control linear
amplifier |
| 3. +150V | 10. Relay common |
| 4. +300V | 11. Relay close on receive |
| 5. +600V | |
| 6. -100V | |
| 7. ALC input | |

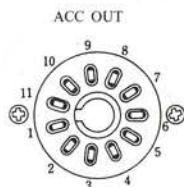

Power socket connections

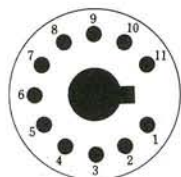

- | |
|---------------|
| 1. -100V |
| 2. E |
| 3. +300V |
| 4. +600V |
| 5. H COMMON |
| 6. H AC 12.6V |
| 7. SPEAKER |
| 8. H AC 12.6V |
| 9. LINE |
| 10. LINE |
| 11. +150V |

EXT VFO



- | |
|--------------------|
| 1. 12VAC |
| 2. GROUND |
| 3. EXT VFO INPUT |
| 4. GROUND |
| 5. INT VFO CONTROL |
| 6. 9VDC OUT |
| 7. 9VDC OUT |

Mic Plug (PTT)

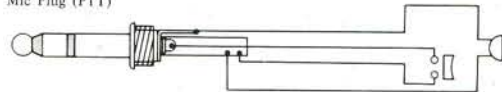

Mic Plug

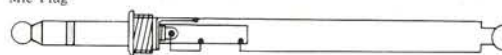

Key Plug

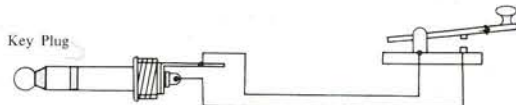

RECEIVE 7MHz SSB NORMAL

(v)

	TUBE	PIN											
		1	2	3	4	5	6	7	8	9	10	11	12
V 1	6U8	150	-1.8	33	AC 6.3	0	145	1	14.5	13.5			
V 2	6BZ6	-0.1	0.8	AC 12.6	AC 6.3	140	60	0					
V 3	6CB6	-0.2	2	AC 6.3	0	145	40	0					
V 4	6EJ7	0	-90	0	AC 12.6	AC 6.3	0	145	0	0			
V 5	12BY7A	0	-90	0	AC 12.6	0	—	350	320	0			
V 6	6JS6A	AC 6.3	0	150	0	-90	—	—	—	-90	0	150	AC 12.6
V 7	6JS6A	0	0	150	0	-90	—	—	—	-90	0	150	AC 6.3
V 8	6AV6	0	1	0	AC 6.3	—	—	110					
V 9	12AU7	25	-0.5	0	AC 6.3	AC 6.3	140	0.35	55	AC 12.6			
V101	6BM8	0	10	0	AC 6.3	AC 12.6	330	140	1	65			
V102	12AX7	-0.2	-95	-95	AC 12.6	0	150	-1.5	0	—			
V103	6BZ6	-0.1	1	AC 6.3	AC 12.6	145	100	1					
V104	6BA6	-0.1	1.2	0	AC 6.3	145	110	1.2					
V105	12AX7	110	0	1	AC 12.6	0	140	0	0	—			
V106	12AU7	0	3.5	6	0	0	130	0.15	6	AC 6.3			
V107	7360	0	150	-95	AC 6.3	0	150	150	30	30			

TRANSMIT 7MHz SSB NORMAL

(v)

	TUBE	PIN											
		1	2	3	4	5	6	7	8	9	10	11	12
V 1	6U8	150	-80	145	AC 6.3	0	150	0	0	-60			
V 2	6BZ6	-60	0	AC 12.6	AC 6.3	145	0	0					
V 3	6CB6	-0.2	2	AC 6.3	0	145	40	0					
V 4	6EJ7	2.2	0	2.2	AC 12.6	AC 6.3	0	145	120	0			
V 5	12BY7A	5	0	0	AC 12.6	0	—	330	240	0			
V 6	6JS6A	AC 6.3	0	150	0	-50	—	—	—	-50	0	150	AC 12.6
V 7	6JS6A	0	0	150	0	-50	—	—	—	-50	0	150	AC 6.3
V 8	6AV6	0	1	0	AC 6.3	—	—	110					
V 9	12AU7	25	-0.5	0	AC 6.3	AC 6.3	100	0.4	PTT15 VOX15	AC 12.6			
V101	6BM8	-80	10	0	AC 6.3	AC 12.6	330	140	1.5	140			
V102	12AX7	-0.2	-95	-95	AC 12.6	0	120	-1.5	0	—			
V103	6BZ6	-60	0	AC 6.3	AC 12.6	150	120	0					
V104	6BA6	0	1.2	0	AC 6.3	140	110	1.2					
V105	12AX7	105	0	1	AC 12.6	0	105	0	1	—			
V106	12AU7	0	3.5	6	0	0	130	0.15	6	AC 6.3			
V107	7360	1.8	90	-1.3	AC 6.3	0	110	110	30	30			

RESISTANCE 7MHz SSB NORMAL

(Ω)

	TUBE	PIN											
		1	2	3	4	5	6	7	8	9	10	11	12
V 1	6U8	8K	500K	500K	0	0	9K	1K	1K	100K			
V 2	6BZ6	3.5M	100	0	0	9K	20K	0					
V 3	6CB6	1.5K	1K	0	0	9K	280K	0					
V 4	6EJ7	470	220K	470	0	0	0	9K	18K	0			
V 5	12BY7A	200	170K	0	0	0	0	∞	∞	0			
V 6	6JS6A	0	0	8K	0	100K	—	—	—	100K	0	8K	0
V 7	6JS6A	0	0	8K	0	100K	—	—	—	100K	0	8K	0
V 8	6AV6	0~250K	2.2K	0	0	—	—	110K					
V 9	12AU7	110K	3.3M	0	0	0	15K	1~3M	8K	0			
V101	6BM8	470K	390	220K	0	0	∞	9K	4.7K	220K			
V102	12AX7	3.3M	1.3M	330K	0	0	∞	100K	4	0			
V103	6BZ6	3.3M	75	0	0	9K	15K	0					
V104	6BA6	3.3M	100	0	0	9K	15K	0					
V105	12AX7	110K	0~250K	2.2K	0	0	110K	220K	2.2K	0			
V106	12AU7	∞	85K	1K	0	0	10K	85K	1K	0			
V107	7360	1K	160K	600K	0	0	35K	35K	55K	55K			

C-CAPACITOR				→117, 123, 137, 138, 139, 148, 502		
63, 161	FM-MICA	500WV	5P ±10%	29, 41, 122, 504, 602	½W	1.5KΩ ±10%
402	"	"	8P "	3, 27, 43, 54, 59,	"	2.2KΩ "
12, 17, 42, 44, 112,	"	"	10P "	134, 160, 405, 409	"	"
139, 201, 306	"	"	"	402, 802	"	3.3KΩ "
11, 119, 132, 141, 403, 417	"	"	20P "	102, 126, 147, 159, 201	"	4.7KΩ "
406	"	"	30P "	505, 509	"	"
602, 99	"	"	40P "	406	"	8.2KΩ "
22, 23, 36, 138	"	"	50P "	1, 9, 46, 52, 62, 64, 72, 73	"	10KΩ "
28, 91, 92, 604	"	"	60P "	111, 114, 118, 163, 302, 401	"	"
38	"	"	70P "	403	"	18KΩ "
134	"	"	80P "	130, 154, 202, 512	"	22KΩ "
16, 20, 31, 35, 49, 89, 90, 113	"	"	100P "	801	"	27KΩ "
116, 117, 122, 123, 127, 142	"	"	"	36, 38, 404, 506, 511	"	33KΩ "
154, 166	"	"	"	37, 39, 40, 42, 47, 119, 143	"	47KΩ "
39, 148, 149, 204, 305	"	"	150P "	144, 146, 149, 151, 152, 153	"	"
605	"	"	170P "	164, 165, 166, 507	"	"
32, 40	"	"	200P "	2, 5, 6, 19, 44, 56, 65, 110	"	100KΩ "
408	"	"	250P "	112, 128, 131, 132, 133, 136	"	"
37, 133, 140, 511	"	"	300P "	140, 155, 156, 303	"	"
30, 601, 603	"	"	350P "	150	½W	150KΩ ±10%
2, 43, 64, 109, 110, 128, 163	"	"	470P "	103, 104, 108, 116, 121	"	220KΩ "
168, 169, 172, 303, 409, 410	"	"	"	125	"	330KΩ "
61, 415	"	"	680P "	20, 23, 26, 105, 135	"	470KΩ "
60	"	"	1000P "	141, 142, 157, 158	"	"
33, 34, 301	"	"	2000P "	7, 8, 127	"	1MΩ "
67	MYLAR	250WV	0.047μ	18, 51	"	1.5MΩ "
7, 8, 106, 107	"	50WV	0.1μ	107, 109	"	2.2MΩ "
124, 302	"	"	"	4, 124, 129	"	3.3MΩ "
151	OIL	400WV	0.047μ	67, 69	1, W	56Ω "
103	"	"	0.01μ	60	"	120Ω "
6	MP	250WV	0.047μ	101	"	390Ω "
41	MICA	1.5KWV	50P	57	"	10KΩ "
55	"	1KWV	100P	33	"	18KΩ "
58	"	3KWV	500P	11, 407, 603, ※75	2 W	22KΩ "
98	CERAMIC	AC3KV	100P	77	5 W	5.6KΩ "
※413	"	500WV	3~5P UJ	55	10W	5KΩ "
※414	"	"	7~10P UJ	VC-VARIABLE CAPACITOR		
404	"	"	20P UJ	1	RPESELECTOR	(330P+20P)×3
420, 421	FEEDTHROUGH BYPASS	500WV	1000P ^{+20%} / ₋₀	2	PLATE	300P MAX
131, 160	ELECTROLYTIC	10WV	10μ	3	LOAD	340P×2
155, 502, 503, 508, 5	"	16WV	10μ	4 0 1	VFO OSC	37P×2
29	"	300WV	20μ	TC-TRIMMER CAPACITOR		
85, 93	"	150WV	1μ	1, 2	KT-G-50P (MICA)	
101	"	15WV	30μ	3	150C 10P 1.5KV AIR	
104	"	150WV	30μ	101, 102	1ZW-10P CERAMIC	
111	"	350WV	10μ	201~206	1ZW-20P CERAMIC	
501	"	16WV	470μ	301	DT-120 50P	
506	CERAMIC DISC	50WV	0.002μ	401	30P AIR	
164	"	500WV	0.0047μ	402	10P×2 AIR	
59, 70, 71, 76	"	14KV	4700P	TR-TRANRISTOR		
46, 50, 202, 401, 405	"	50WV	0.01μ	201, 401, 402, 502, 801	2SC372Y	
407, 411, 416, 418, 504	"	"	"	301, 501	2SC367Y (25C735Y)	
505, 507, 509, 510	"	"	"	503	2SC373 (25C828 Q)	
4, 14, 18, 68, 144	CERAMIC DISC	500WV	0.001μ	D-DIODE		
157, 1008	"	"	"	1~5, 101~103, 106	SH-1 (1S1941) SILICON	
3, 9, 13, 15, 19, 24, 25, 27,	"	500WV	0.01μ	6, 7, 104, 105, 301	1S1007 GER.	
45, 47, 48, 51, 53, 54, 56, 57	"	"	"	401	1S145 VARI CAP.	
65, 66, 69, 73, 75, 78, 87, 88	"	"	"	501	1S336 11V ZENER	
94, 100, 1001, 1007, 102, 105	"	"	"	502	1S336 6V ZENER	
108, 114, 115, 118, 120, 121	"	"	"	VR-VARIABLE RESISTOR		
125, 126, 129, 130, 136, 137	"	"	"	1	AF+RF GAIN	500K-A+10K-C
143, 145, 146, 147, 150, 152	"	"	"	2	MIC GAIN	500K-A
153, 156, 158, 159, 162	"	"	"	3	ANTI TRIP	100K-B
72, 74, 80~83, 95, 96, 97	"	"	"	4	VOX GAIN	500KA
203, 205, 206, 207, 304, 419	50WV	0.047μ	"	5	DELAY	3M-B
R-RESISTOR				6	CLARIFIER	50KB+SW
63	½W	22Ω ±10%	"	7	(RFA)	50K-B (20KB)
66, 68, 70, 71	"	56Ω "	"	8	CARRIER	3M-B
115	"	68Ω "	"	9	RELAY SENS	3K-B
10, 25, 120, 411, 412, 805, 513	"	100Ω "	"	101	(ALC ADJ)	2K-B
48, 510, 803	"	150Ω "	"	102	(AGC ADJ)	10K-B
301, 408, 410, ※78, 804	"	220Ω "	"	103	BIAS	20K-B
145, 203, 204	"	330Ω "	"	104	SM-SENS	5K-B
501	"	390Ω "	"	105	SM-ZERO	500-B
45	"	470Ω "	"	106	CARRIER BALANCE	5K-B
503	"	560Ω "	"	501	(VOLT ADJ)	1K-B
76	"	680Ω "	"	502	(TONE OUT ADJ)	10K-B
21, 22, 28, 32, 53 →	"	1KΩ "	"	503	(TONE F ADJ)	10K-B
				504	(TONE OSC ADJ)	10K-B

RL-RELAY			L-INDUCTOR		
1	(ANT)	AE3254 DC100V	1	TRAP (9MHz)	USTC 0.06/4 40T
2		AE3218 DC12V	2	"	"
101	(VOX)	AE3254 DC100V	3	10M (LOCAL OSC) (BPF COIL)	0.6φ 3T, S
XF-CRYSTAL FILTER					
101		XF-9 9MHz	4	15M	" 0.6φ5T; 5 ³ / ₄ T
X-CRYSTAL					
101	(LSB)	HC/18U 9001.5KHz	5	40	" 0.4φ8T; 8 ³ / ₄ T
102	(USB)	" 8998.5KHz	6	80/20"	" 0.06/4 97T; 1/2W1.5KΩ
201	7.0	HC/18U 11MHz	7	80/40"	RF COIL 0.06/4 23T
202	21.0	" 33.5MHz	8	10	" 0.6φ 5T, S
203	28.0 (OPTION)	" 42.5MHz	9	15	" 0.3φ 8T
204	28.5	" 43.0MHz	10	20	" 0.3φ 8T
205	29.0 (OPTION)	" 43.5MHz	11	RFC	TV-245
206	29.5 (")	" 44.0MHz	12	80/40M	RF COIL 0.06/4 23T; 0.3φ5T
301	CALIB	HC/13U 100KHz	13	10	" 0.4φ 5T
PL-PILOT LAMP					
1, 2		15V SWAN	14	15	" 0.3φ 8T
T-TRANSFORMER					
1	(OPT)	5K; 600 8Ω	15	20	" 0.3φ 8T
M-METER					
1		TYPE 45 500μA (SHUNT)	16, 18, 24	PARASTIC COIL	1/2W56Ω 4TS 0.6φ
PB-PRINTED BOARD					
PB-1046	GENERATOR		17, 19	"	1W 56Ω 4TS 1φ
" 1061	VFO		20	PLATE RFC	0.29φ 12φ×75
" 1068	CALIBRATOR		21	TANK COIL	1.2φ 30φ×65
" 1044	VFO BPF		101	IFT (9MHz)	0.3φ 15T 9.5TAP
" 1066	VOLT REG+TONE OSC		102	" "	0.3φ 15T
" 1041	HETERODYNE OSC		103	FILTER OUT	0.16φ 8T; 0.3φ 17T
" 1093	BUFF		104	" IN	0.3φ 13T
S-SWITCH					
1	BAND 1	5-10-5	105	BM-T	0.16φ 4T; 0.3φ 18T
2	" 2	1-2-4	23, 106, 107, 201, 403	MICRO INDUCTOR	250μH
3	FUNCTION	4-8-5	202	HET OSC OUT	
4	SIDE BAND	MS-102-1	401	VFO OSC (15φ×32)	
5	PTT/VOX	"	601, 607	BAND PASS (VFO)	0.08 50T
6	OPER/REC/CAL		301		4mH
7	ALC/IC/PO	SS(H) 23 08	(AC POWER SUPPLY)		
8	VFO SELECT	ESR-E1-4-3	C-CAPACITOR		
9	POWER	AM5206 (S3)	101, 102	ELECTROLYTIC	
V-VACUUM TUBE					
1		6U8	103~105	450WV 47μ×2 or (40μ×2)	
2, 103		6BZ6	106	450WV 33μ×3 or (40+40+20)	
3		6CB6	107	ELECTROLYTIC	
4		6EJ7	108	300WV 47μ (40μ)	
5		12BY7A	109, 110, 514, 515	ELECTROLYTIC	
6, 7		6JS6A	501~504, 509~5	160WV 22μ (20μ)	
8		6AV6	509~512	CERAMIC DISC	1.4KV DC 0.01μ
9, 106		12AU7	513	CERAMIC DISC	1.4KV DC 4700P
101		6BM8	517	CERAMIC DISC	500WV 0.01μ
102, 105		12AX7A	R-RESISTOR		
104		6BA6	101, 102, 501, 503	1/2W 470KΩ±10%	
107		7360	505, 507	"	
VS-VACUUM TUBE SOCKET					
1, 4, 5, 9		(9P) SB-1222	516	1 W 22KΩ±10%	
8		(7P) SB-0822	513	" 4.7KΩ "	
2, 3		(7P) S7-201Y-04	517	4 W 5.6Ω	
6, 7		(12P) SB-0703	D-DIODE		
101, 102, 105, 106		(9P) SB-1307-2	501, 503, 505, 507	SILICON 10D10	
103, 104		(7P) SB-0905-2	509~512	"	1S1944
107		(9P) SB-1330-2	513	"	1S1943
J-JACK					
1	PHONES	SG-7615 2P	T-TRANSFORMER		
2	SP	RCA-7017	101	POWER TRANS	
3	MIC	SG-7814-1 3P	CH-FILTER CHOKE		
4	KEY	SG-7615 2P	101, 102	2.5H 150mA	
5	RF OUT	RCA-7017	SP-SPEAKER		
6	ANT	JSO-239 (INCH)	SP	VC8Ω 1.5W	
7	POWER	PA-603B (11P)	FH-FUSE HOLDER		
8	ACC	SA-602B (11P)	101	S-N1001	
9	EXT VFO	SB-0821 (7P)	F-FUSE		
P-PLUG					
1, 4		S-H3001 (2P)	101	117V 5A	
2, 5		RCA-7017	PRINTED BOARD		
3		S-H3601 (3P)	PB-1004-2		
6		M-P-7 (INCH)	J-JACK		
7		FS-A604B (11P)	101	(POWER)	SA-602B (11P)
8		PA-602B (11P)			
9		S-I 7302 (7P)			

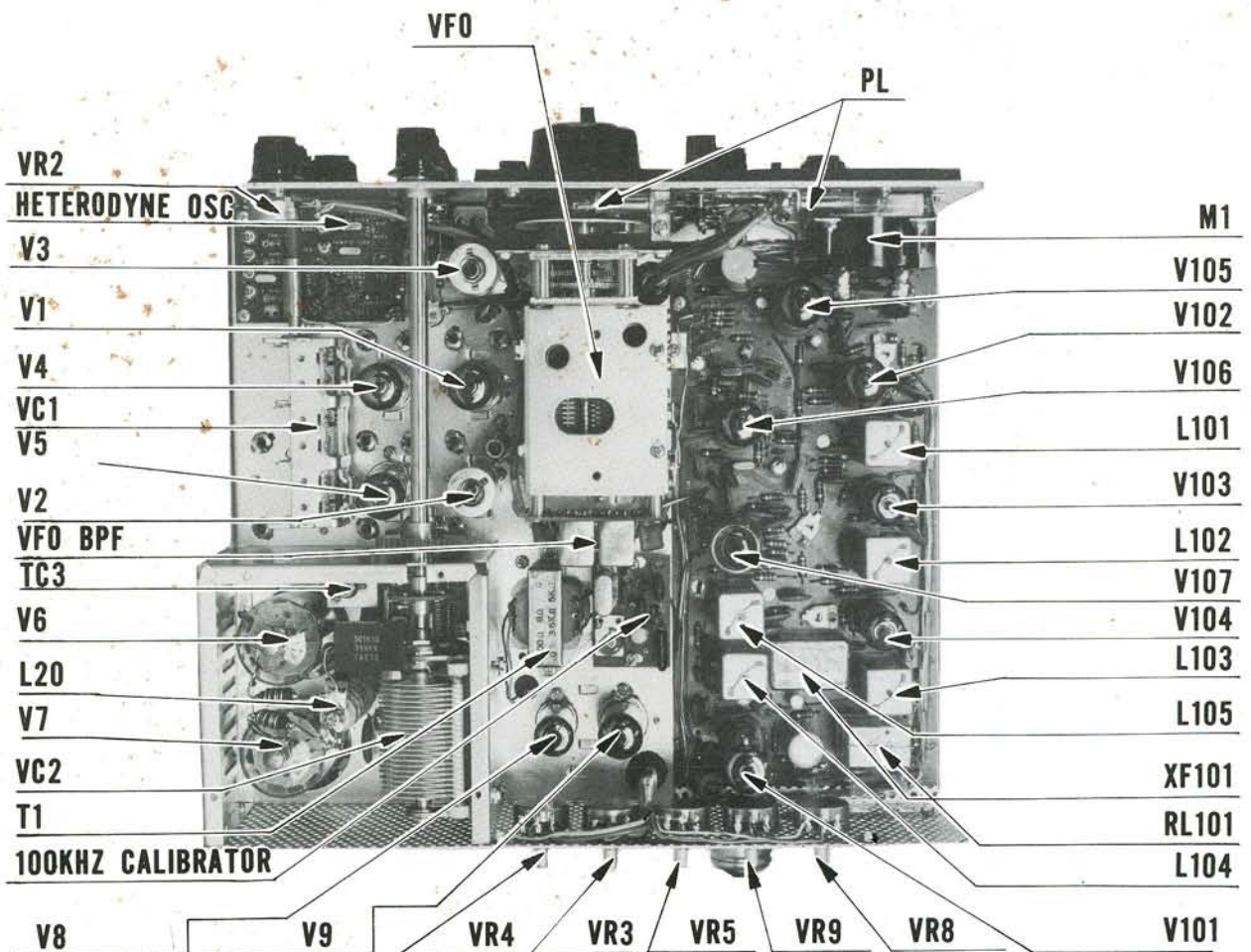
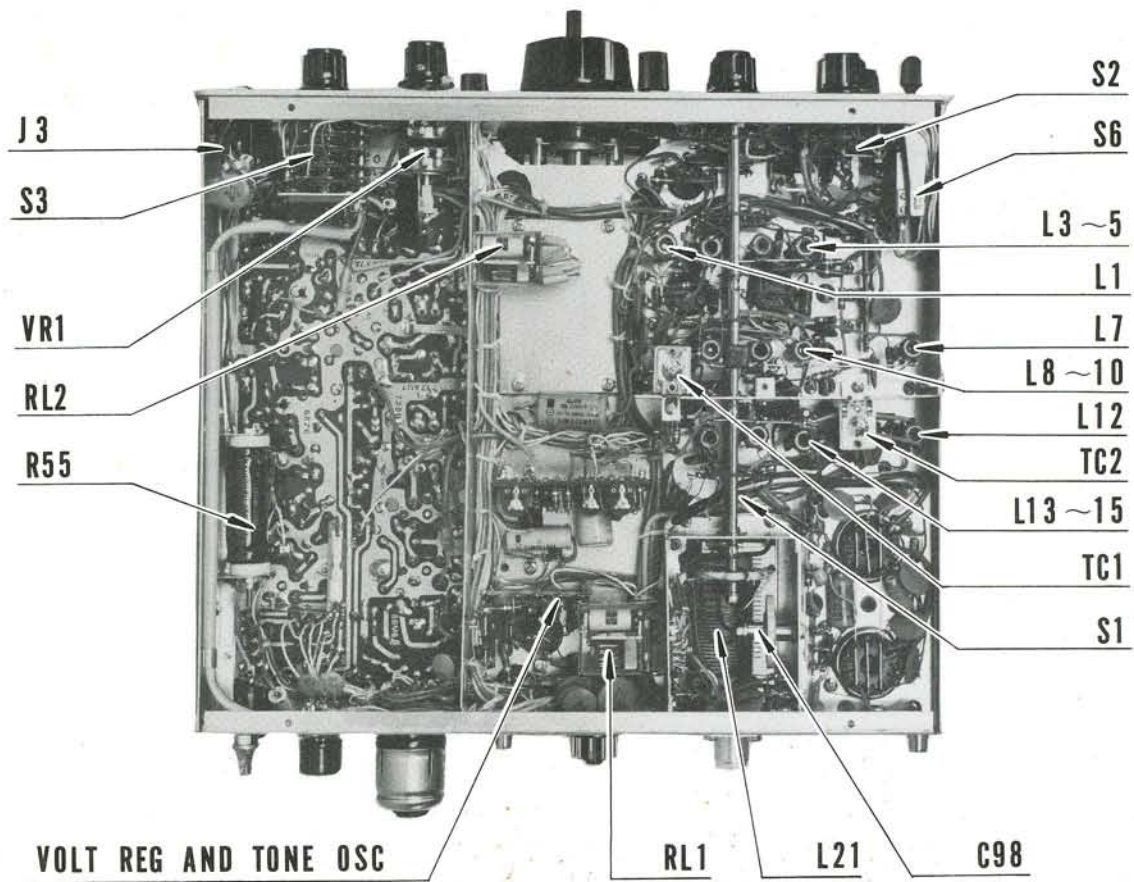

DC - 200 / 250 DC POWER SUPPLY

The DC-200/250 DC mobile supply is designed for the FT-200/250 Transceiver. This supply provides all necessary voltages from 12 volt battery for mobile operation.

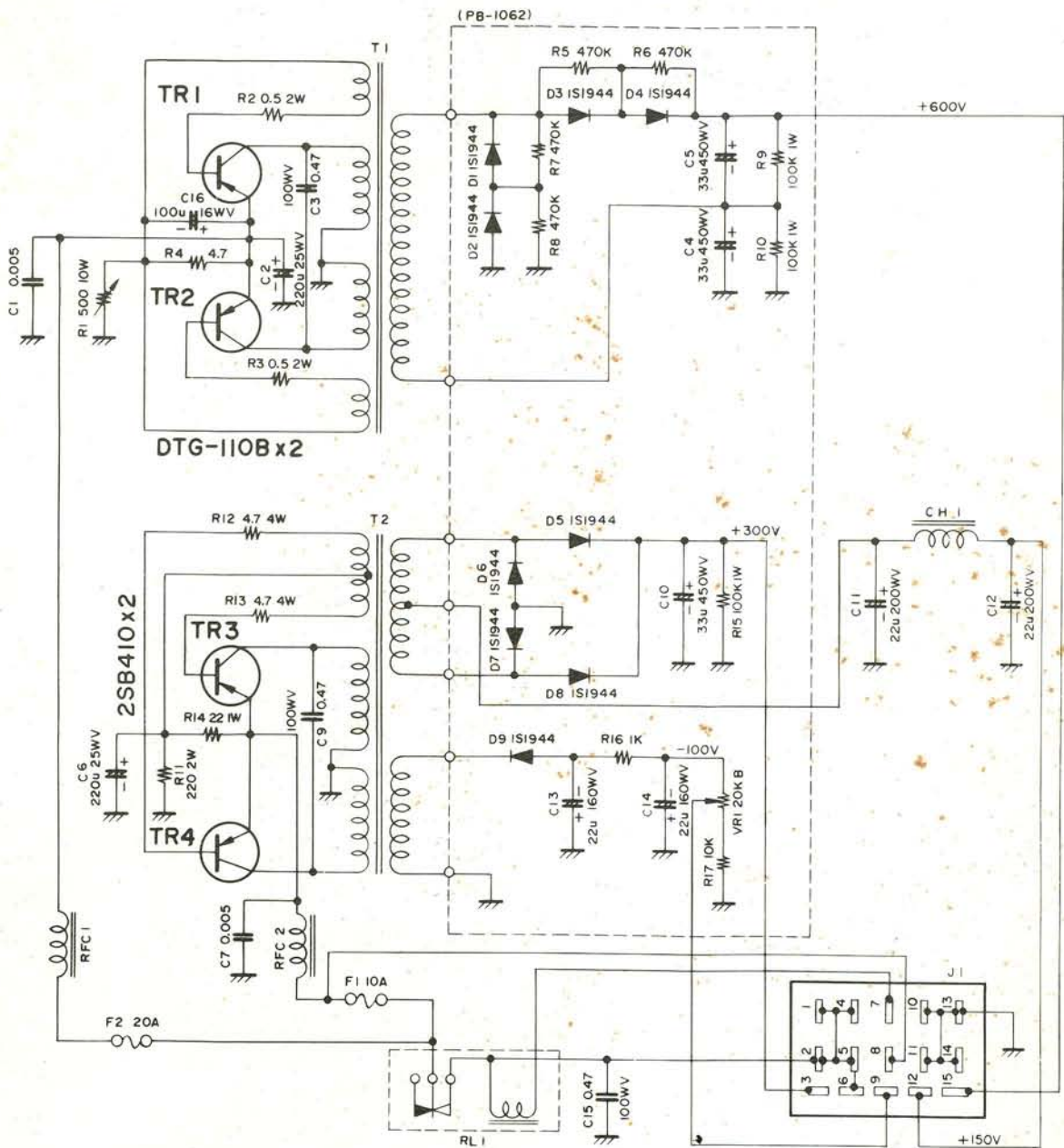
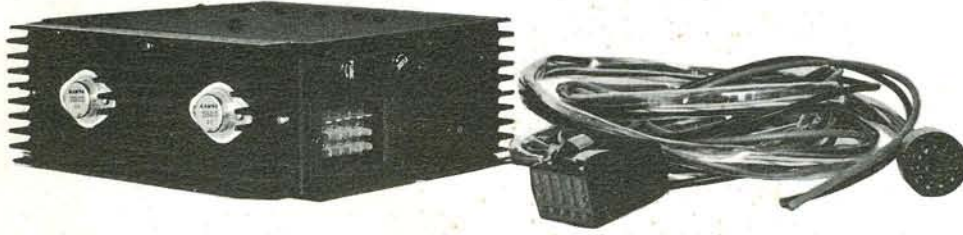

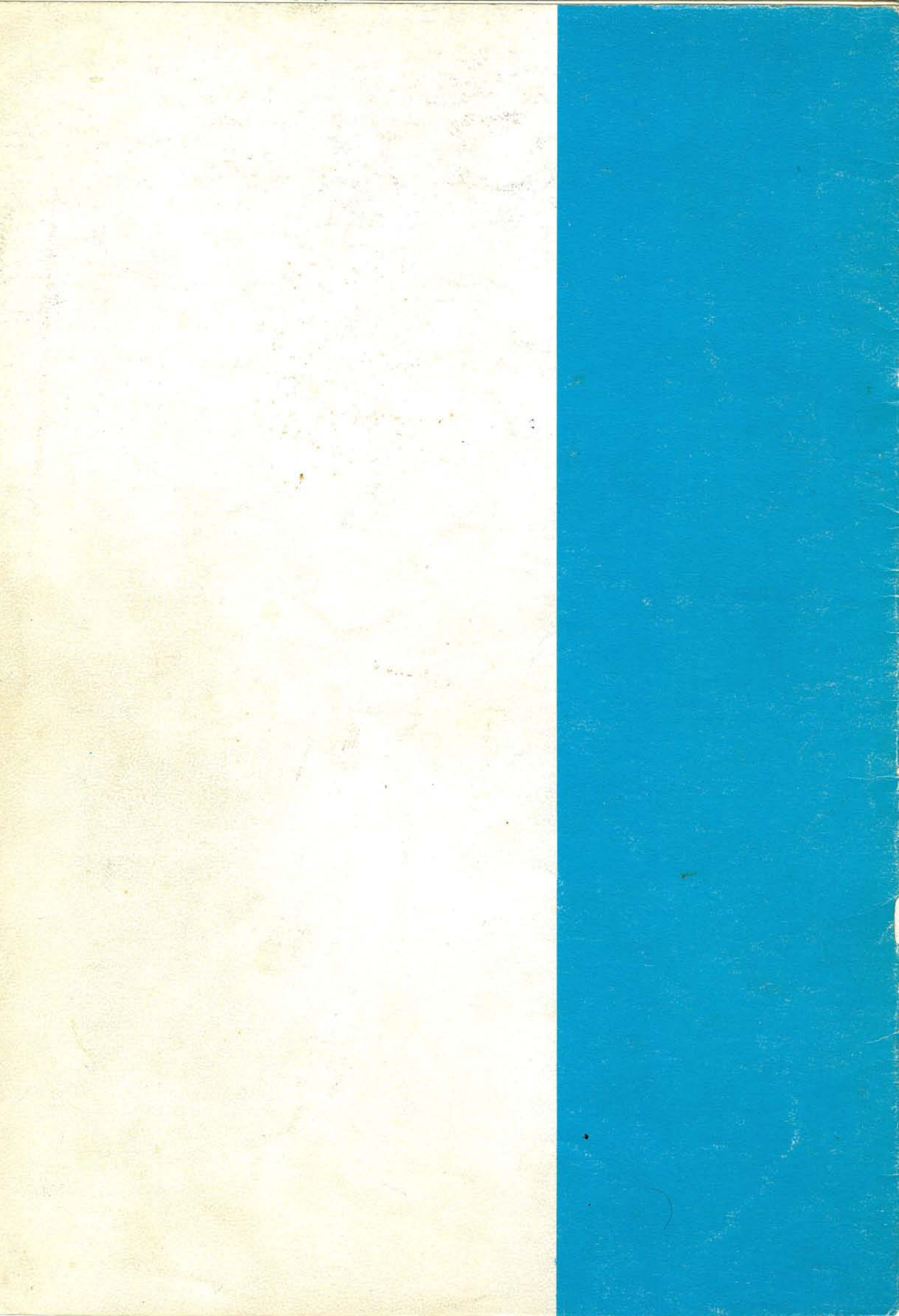

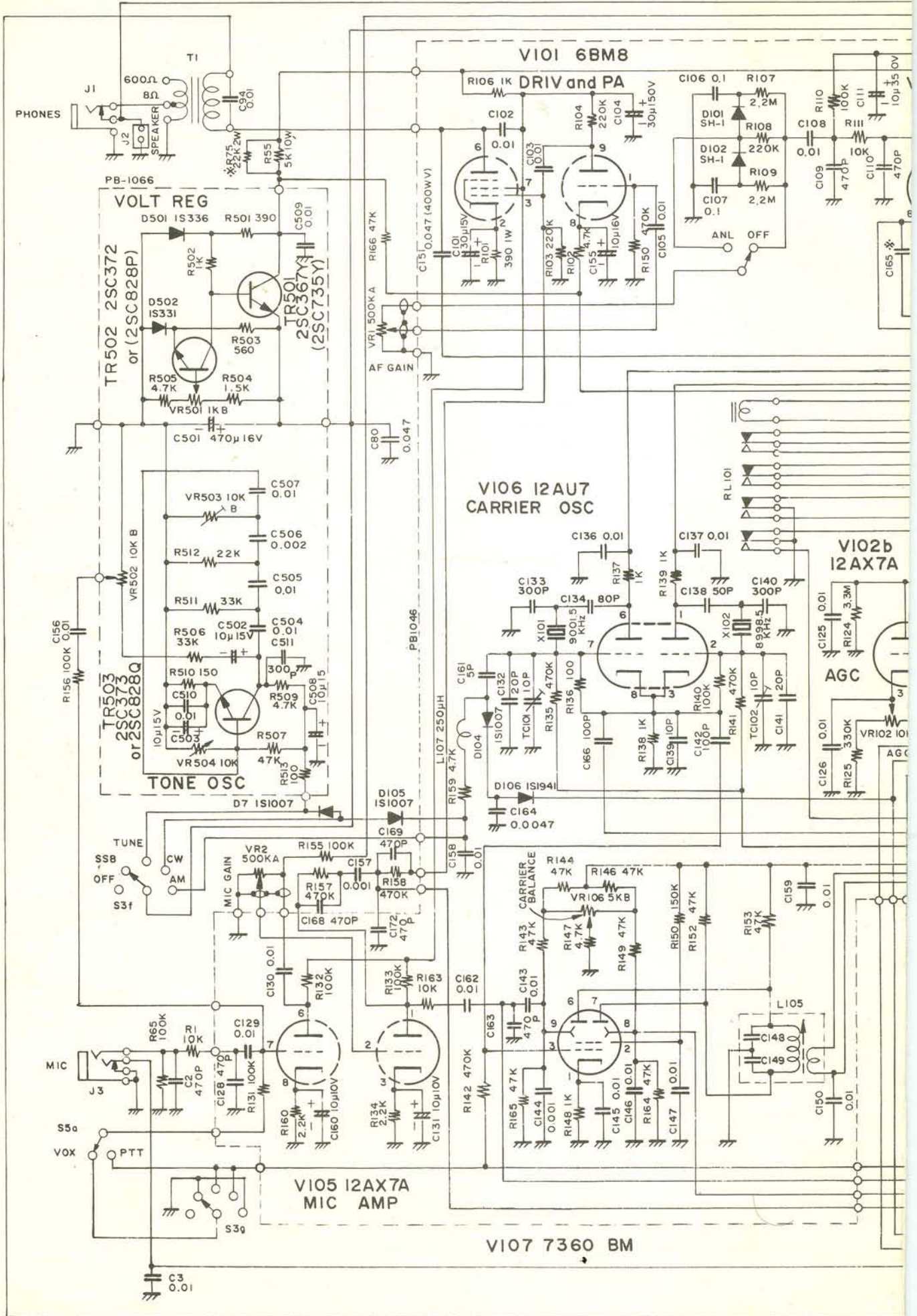

102a 12AX7A
SSB CW DET

V103 6BZ6
2nd IF AMP

V104 6BA6
1st IF AMP

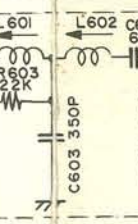
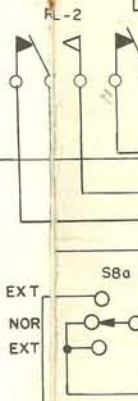
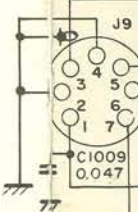
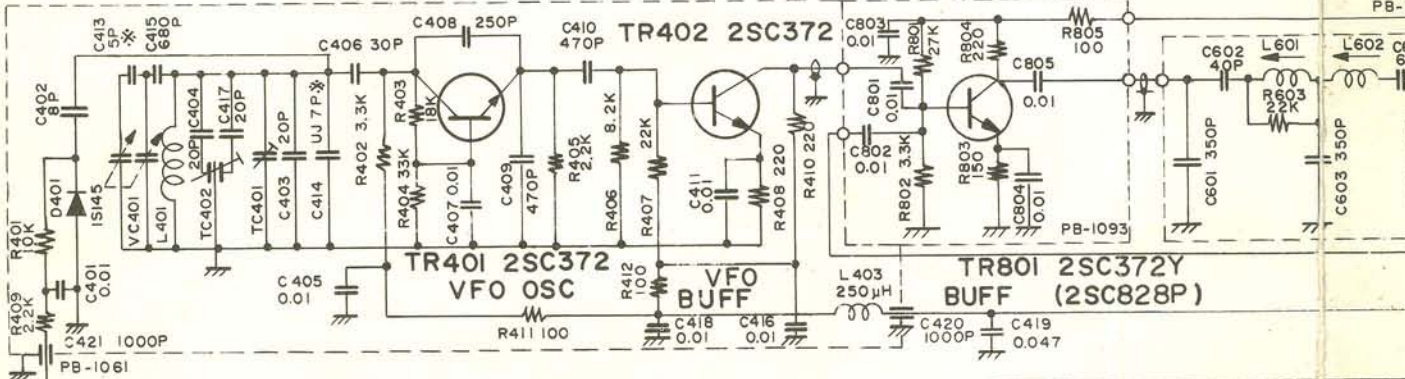
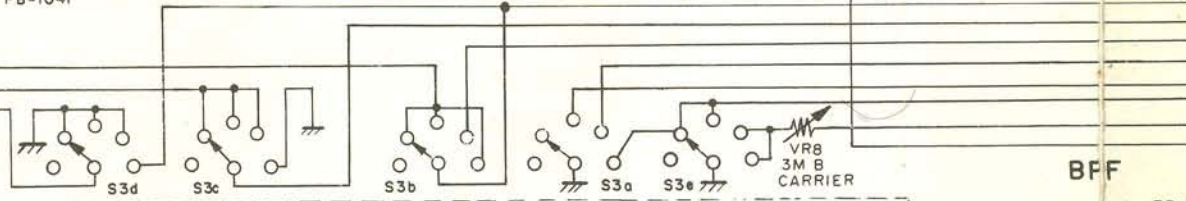
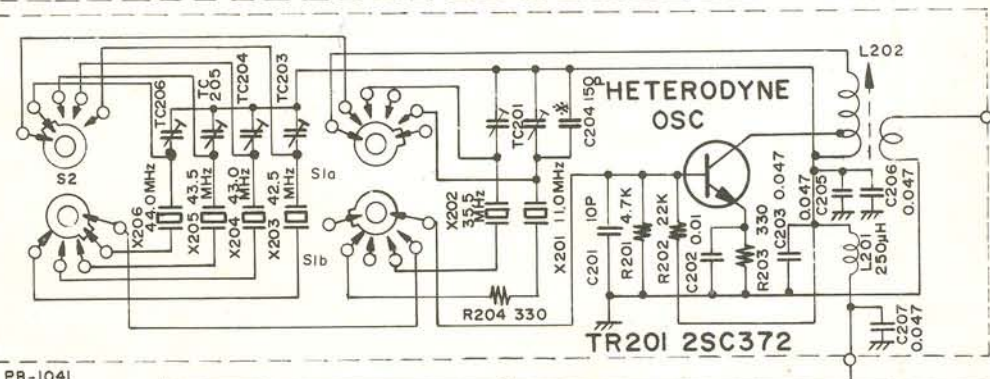
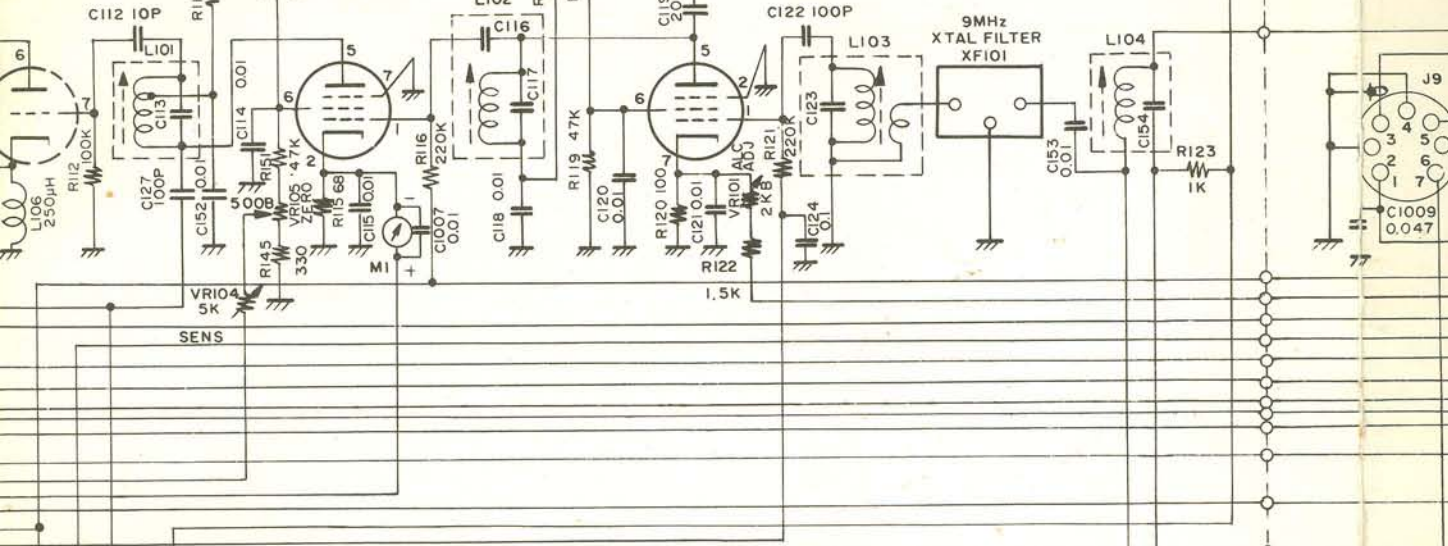

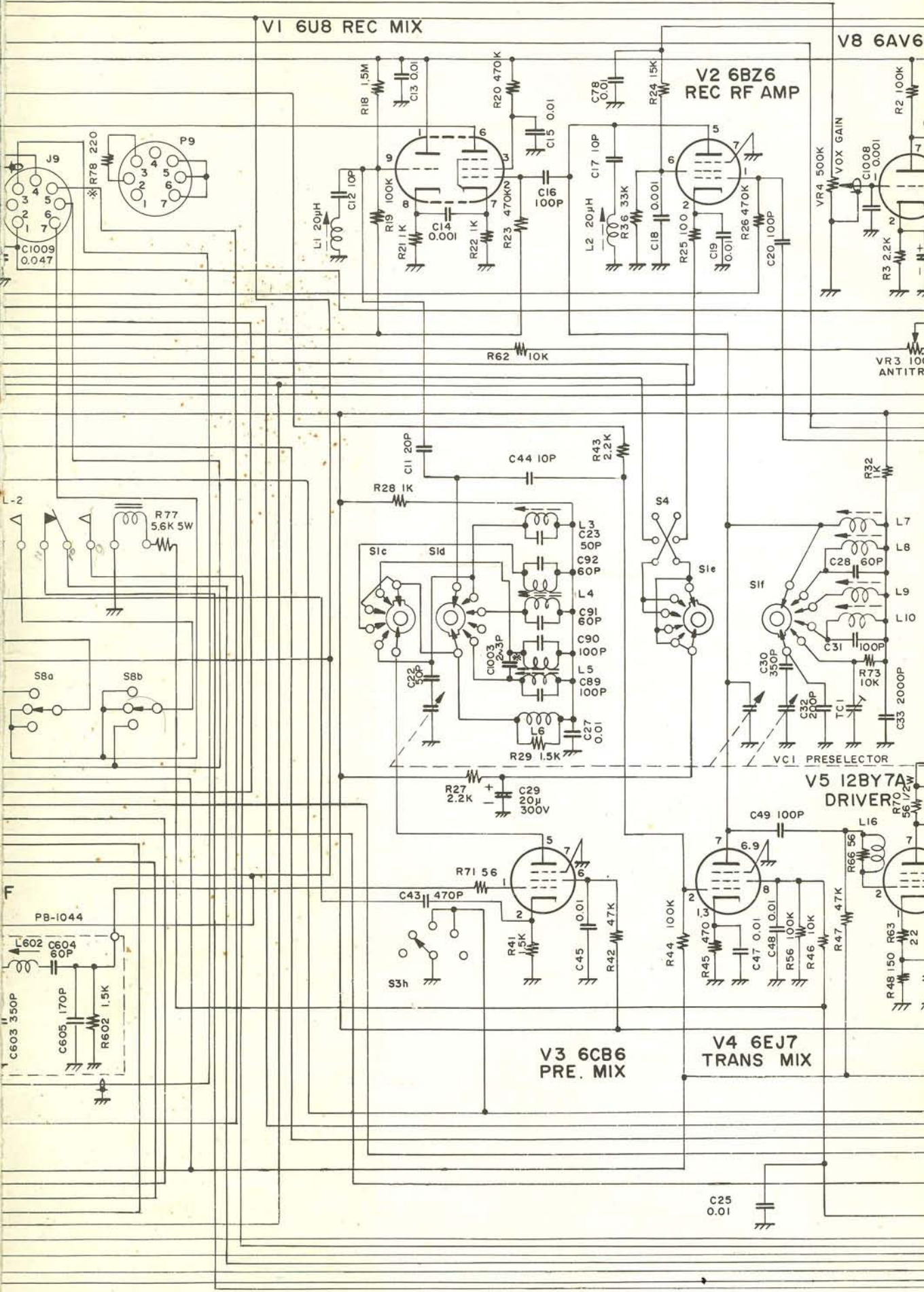

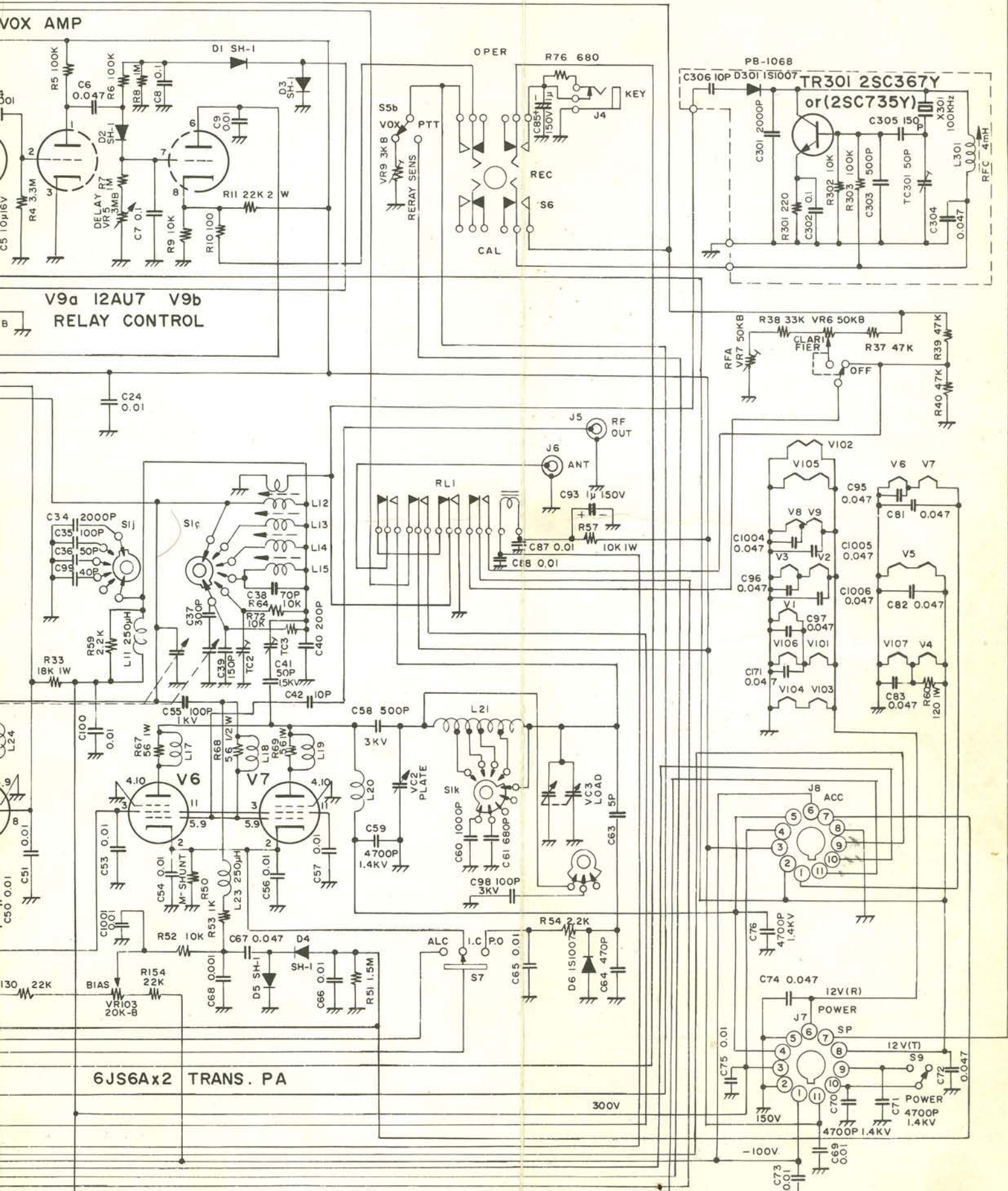

D1 ~ D5 }
 D101 ~ D103 } SH-1 or 1S1941
 D106 }

- NOTES:
1. ALL RESISTORS IN OHM 1/2W ± 10% UNLESS OTHERWISE NOTED.
 2. ALL CAPACITORS IN μF UNLESS OTHERWISE NOTED.
 3. * VALUE IS NOMINAL.

FT-200/250

CIRCUIT DIAGRAM