

DJ-S41

Lift the bottom tab and lift the battery-case cover. Insert three AA drycells or NiCd battery cells here; close, and lock with the bottom tab.

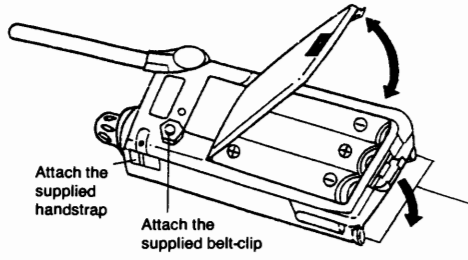

Charger terminals: Be careful not to touch with metals/conductives.

DISPLAY

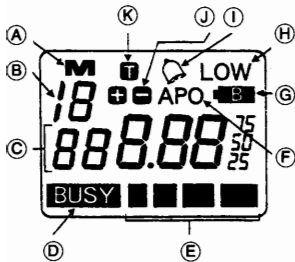

- A "M" is displayed continuously on a programmed memory channel. The "M" flashes on a memory channel not yet programmed.
- B Memory channel number.
- C Frequency (and other parameters when programming functions)
- D "BUSY" appears upon receiving a signal.
- E S-meter/RF output power meter
- F Auto Power Off enabled
- G Low Battery Indicator (Flashes when needs replacement or charge)
- H Low Power Output mode indicator
- I Alarm function ON
- J Offset shift direction
- K CTCSS tone encoder ON

QUICK REFERENCE CHART

Condition Key	Pressed alone	Pressed while F is pressed	Press and hold and turn the power on
F	if released quickly, freq. change by digits		reset
MONI	unmutes squelch	keylock/unlock	beep on/off
PTT	transmits		
V/M	VFO ← → Memory	Mem. write mode: Select CH by UP/DOWN key, & press V/M to write.	Channel Indication Mode
UP	freq./mem up (scans if pressed a while) (If pressed with PTT, emits alert tone.)	channel step	Courtesy beep ON
DOWN	freq./mem down (scans if pressed awhile) (If pressed with PTT, emits alert tone.)	tone freq. change	Courtesy beep OFF
CALL	call channel	alarm on/off	alert/1750Hz
SCAN	scan start With PTT, toggles power Hi/Low	offset programming	
LAMP	lamp on/off	Auto Power Off	change lamp mode

FEATURES

Antenna I

Rotate and let the antenna stand up when operating.

External Power Terminal I

Do not connect any power supply when dry cells are installed in the radio.

If NiCd batteries are installed, charging* can be done through this terminal using the EDH-18, EDC-78/79 charger, or an external regulated 5.5V DC source (negative ground).

(Do not use any other types of charger unless the radio will be damaged and warranty will be void.)
*Applicable only for charge-capable version radio with "C" marked in the lower-right corner of the back sticker.

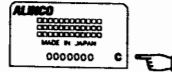

External Microphone Jack I

Connect to this jack when using an optional microphone (e.g. EMS-9, EME-12, etc.)

External Speaker Jack I

Connect to this jack when using an optional speaker (e.g. EMS-9, EME-12, etc.)

PTT I

Press-to-talk switch.

MONITOR I

Press this switch to unmute the preset squelch and monitor weak signals. Press and hold the F-key and press this key to lock/unlock the keys to avoid unintended key entries. ("L" is displayed during the keylock.)

Function (F) I

Press and hold this key and press another key to activate the secondary function. Press and release this key quickly to change the blinking frequency digit; the blinking digit can be changed with the UP/DOWN keys (DJ-S41T only).

V/M/MW I

Changes between VFO and memory channel. To program a memory channel, (1) in the VFO mode, press and hold the F-key and press this key, (2) Use the UP/DOWN key to select a memory channel number, (3) Press this key again to memorize the displayed frequency (including the offset and tone encoder) to that channel. Memory channels available are: c, 0 - 19.

DOWN/tone I

Press this key to change frequency/channel downwards. Press this key while pressing the F-key to enter programming mode for the CTCSS encoder. Then press this key to change the encoding tone frequency. Press the F-key with this key again to the display/erase the  in the LCD that turns on/off the encoder. Press PTT to exit.

Pressing the UP or DOWN key while transmitting will emit 1750Hz tone or the alerting ring to raise the attention of the called party. This sound can be toggled between 1750Hz or the alerting ring by press and holding the CALL key (see below) and turning on the power. Press the UP or DOWN key for a few seconds to start scanning.

UP/step I

Press this key to change frequency/channel upwards. Press this key while pressing the F-key to enter programming mode for the channel step. Press this key to change the channel step. Press PTT to exit.

Microphone I

Speaker I

LAMP/APO I

Press this key to illuminate the LCD for 5 seconds. Press and hold the F-key and press this key to toggle the APO (auto-power-off); Use the UP/DOWN keys to change the automatic power off timer from OFF to 120 min. in 30 min. step. Press and hold this key and turn the power on, then the 5 second illumination timer is disabled; the lamp is toggled on/off with the key regardless of the time passed.

LCD I

SCAN/SHIFT I

Press this key to scan. Press and hold the F-key and press this key to set the semi-duplex offset frequency. Each press of the key in the offset setting mode changes the shift direction + or -. Press PTT to exit.

DJ-S41T only:
While pressing PTT, press this key to toggle transmission output High/Low (LOW appears in the LCD when in Low power mode).

CALL/BELL I

Pressing this key changes your operating frequency to memory ch "C". Pressing again resumes the original frequency. Press and hold the F-key and press this key to turn on/off the alarm function; the function alarm: you with an electronic sound when a signal is received. ( appears in the LCD.)

Power switch and Volume I

< General >

- Frequency range/DJ-S41T 425.000 ~ 449.995MHz, DJ-S41(C) 433.050 ~ 434.790MHz • Modulation/F3E • DC power source/3.6 ~ 4.5V (internal battery), 5.5V (external regulated source)
- Current TX/approx. 260mA (30mA S-41(c)) @4.5V DC, RX/approx. 33mA (squelched) • Dimensions/55(W) x 100(H) x 28(D)mm without projections • Weight/approx. 185g (with three AA drycells)

< Transmitter >

- Output Power/approx. 340mW (10mW S-41(c)) @4.5V DC
- Modulator/Variable reactance • Max. deviation/±5kHz

< Receiver >

- Configuration/Double conversion superheterodyne • I.F./1st: 23.05MHz/2nd: 450kHz • Sensitivity/better than -15dBμ (12dB SINAD) • AF output/not less than 100mW (10% distort. @8Ω)

ALINCO, INC.

Head Office: "TWIN 21" MID Tower Building 23F
1-61, 2-Chome, Shiromi, Chuo-ku, Osaka 540, Japan
Phone: 06-946-8150 Fax: 06-946-8175 Telex: 63088
E-mail: 101243.1446@compuserve.com

PS0270
Printed in Japan

OTHER FUNCTIONS

- **Courtesy Beep:** A short beep is emitted on your transmitting signal upon each release of the PTT key, to let the other party "goahead" and talk. To toggle on this function, press and hold the UP key and turn on the power. To toggle off, do the same with the DOWN key.

- **Reverse:** To monitor the uplink frequency of the repeater (when an offset has been programmed), press F + SCAN, then press and hold the MONITOR key. Releasing the MONITOR key will cancel the reverse reception and pressing PTT will bring back to the original state.

- **Key Stroke Beep Sound:** The beep heard with each stroke of keys can be toggled on/off, by pressing and holding the MONITOR key and turning the power on.

- **Channel Display Mode:** Only the memory channel number (and not the frequency) is displayed. If your operation is limited on your "usual" channels only, this setting may be useful. This mode can be entered/exited by press/holding the V/M key and turning the power on.

Resetting: Press and hold the F-key and turn on the power.

OPTIONS

- Battery Charger MW818 (220V AC input)
- Headset with VOX EME-12 (Earpad type)
EME-13 (Earphone type)
- Tie-pin mic. and earphone with VOX EME-15
- Speaker Microphone EMS-9
- Earphone Mic. EME-4
- Soft Case ESC-27
- Car lighter DC cable with voltage conversion to 5.5V DC EDH-18
- Mobile bracket EBC-6

EC10

Lift the bottom tab and lift the battery-case cover. Insert three AA drycells or NiCd battery cells here; close, and lock with the bottom tab.

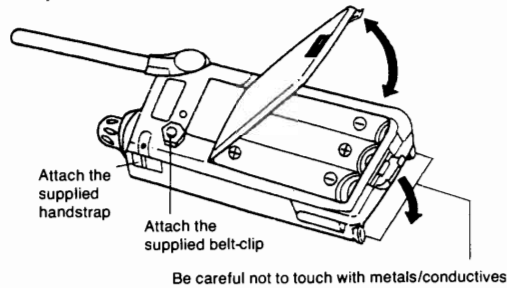

■ DISPLAY

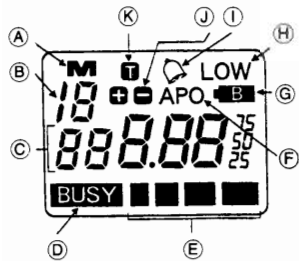

- A "M" is displayed continuously on a programmed memory channel. The "M" flashes on a memory channel not yet programmed.
- B Memory channel number.
- C Frequency (and other parameters when programming functions)
- D "BUSY" appears upon receiving a signal.
- E S-meter/RF output power meter
- F Auto Power Off enabled
- G Low Battery indicator (Flashes when needs replacement or charge)
- H Low Power Output mode indicator
- I Alarm function ON
- J Offset shift direction
- K CTCSS tone encoder ON

■ QUICK REFERENCE CHART

Condition Key	Pressed alone	Pressed while F is pressed	Press and hold and turn the power on
F			reset
MONI	unmutes squelch	keylock/unlock	beep on/off
PTT	transmits		
V/M	VFO ← → Memory	Mem. write mode: Select CH by UP/DOWN key, & press V/M to write.	Channel Indication Mode
UP	freq./mem up (scans if pressed a while) (If pressed with PTT, emits alert tone.)		Courtesy beep ON
DOWN	freq./mem down (scans if pressed awhile) (If pressed with PTT, emits alert tone.)	tone freq. change	Courtesy beep OFF
CALL	call channel	alarm on/off	alert/1750Hz
SCAN	scan start	offset programming	
LAMP	lamp on/off	Auto Power Off	change lamp mode

Copyright © 1996 Alinco, Inc., Osaka, Japan. All rights reserved. No part of this manual may be reproduced, copied, translated, or transcribed in any form or by any means without the prior written permission of Alinco, Inc. Names of products used in this manual are for identification or description purpose only and may be trademarks or registered trademarks of their respective company.

■ FEATURES

Telescopic Antenna I

Rotate, stand up and extend fully when operating

External Power Terminal I

Do not connect any power supply when dry cells are installed in the radio.
If NiCd batteries are installed, charging can be done through this terminal using the EDH-18, EDC-79 charger, or an external regulated 5.5V DC (negative ground). (Do not use any other types of charger or else the radio will be damaged and warranty will be void.)

External Microphone Jack I

Connect to this jack when using an optional microphone (e.g. EMS-9, EME-12, etc.)

External Speaker Jack I

Connect to this jack when using an optional speaker (e.g. EMS-9, EME-12, etc.)

PTT I

Press-to-talk switch.

MONITOR I

Press this switch to unmute the preset squelch and monitor weak signals. Press and hold the F-key and press this key to lock/unlock the keys to avoid unintended key entries. ("L" is displayed during the keylock.)

Function (F) I

Press and hold this key and press another key to activate the secondary function. Press and release this key quickly to change the blinking frequency digit; the blinking digit can be changed with the UP/DOWN keys.

V/M/MW I

Changes between VFO and memory channel. To program a memory channel, (1) in the VFO mode, press and hold the F-key and press this key, (2) Use the UP/DOWN key to select a memory channel number, (3) Press this key again to memorize the displayed frequency (including the offset and tone encoder) to that channel. Memory channels available are: c, 0 - 19.

DOWN/tone I

Press this key to change frequency/channel downwards. Press this key while pressing the F-key to enter programming mode for the CTCSS encoder. Then press this key to change the encoding tone frequency. Press the F-key with this key again to the display/erase the **1** in the LCD that turns on/off the encoder. Press PTT to exit.
Pressing the UP or DOWN key while transmitting will emit 1750Hz tone or the alerting ring to raise the attention of the called party. This sound can be toggled between 1750Hz or the alerting ring by press and holding the CALL key (see below) and turning on the power. Press the UP or DOWN key for a few seconds to start scanning.

UP I

Press this key to change frequency/channel upwards. Press this key while pressing the F-key to enter programming mode for the channel step. Press this key to change the channel step. Press PTT to exit.

Microphone I

Speaker I

UHF FM MINI POWER TRANSCEIVER

■ SPECIFICATIONS:

< General >

- Frequency range / 433.0625 - 434.7750MHz
- Modulation / F3E
- DC power source / 3.6 - 4.5V (internal battery), 5.5V (external regulated source)
- Current TX / approx. 30mA @ 4.5V DC, RX / approx. 33mA (squelched)
- Dimensions / 55(W) x 100(H) x 28(D)mm without projections
- Weight / approx. 185g (with three AA drycells)

< Transmitter >

- Output Power / approx. 10mW @ 4.5V DC
- Modulator / Variable reactance
- Max. deviation / ± 5kHz

< Receiver >

- Configuration / Double conversion superheterodyne
- I.F. / 1st: 23.05MHz / 2nd: 450kHz
- Sensitivity / better than -15dBμ (12dB SINAD)
- AF output / not less than 100mW (10% distort. @ 8Ω)

ALINCO, INC.

Germany: Eschborner Landstrasse 55, 60489 Frankfurt am Main, Germany
Phone: 069-786018 Fax: 069-789-60766
Head Office: "TWIN 21" MID Tower Building 23F
1-61, 2-Chome, Shiromi, Chuo-ku, Osaka 540, Japan
Phone: 06-946-8150 Fax: 06-946-8175 Telex: 63086
E-mail: 101243.1446@compuserve.com PS0246
Printed in Japan

■ OTHER FUNCTIONS

- **Courtesy Beep:** A short beep is emitted on your transmitting signal upon each release of the PTT key, to let the other party "go ahead" and talk. To toggle on this function, press and hold the UP key and turn on the power. To toggle off, do the same with the DOWN key.
- **Key Stroke Beep Sound:** The beep heard with each stroke of keys can be toggled on/off, by pressing and holding the MONITOR key and turning the power on.
- **Channel Display Mode:** Only the memory channel number (and not the frequency) is displayed. If your operation is limited on your "usual" channels only, this setting may be useful. This mode can be entered/exited by press/holding the V/M key and turning the power on.

Resetting: Press and hold the F-key and turn on the power.

■ OPTIONS

- Battery Charger EDC-79 (220V AC input)
- Headset with VOX EME-12 (Earpad type)
EME-13 (Earphone type)
- Tie-pin mic. and earphone with VOX EME-15
- Speaker Microphone EMS-9
- Earphone Mic. EME-4
- Soft Case ESC-27
- Car lighter DC cable with voltage conversion to 5.5V DC EDH-18
- Mobile bracket EBC-6

■ СВОДНАЯ ТАБЛИЦА ДЛЯ ПОЛЬЗОВАТЕЛЯ

Кнопка	Нажатие на кнопку	Нажатие на кнопку при нажатой кнопке F	Включение питания при нажатой кнопке
F (функция) "Function"	изменение одного из разрядов частоты (при коротком нажатии)		возврат к предыдущим установкам
КОНТРОЛЬ "MONI"	открытие шумоподавителя	блокировка или разблокировка кнопок	включение или выключение звуковых сигналов
ПЕРЕДАЧА "PTT"	передача		
ЧАСТОТА-ПАМЯТЬ "V/M"	переключение частота — канал	запись в память: выбрать каналов по "UP/DOWN", и нажмите V/M снова.	режим индикации каналов
ВВЕРХ "UP"	увеличение частоты или канала. При длительном нажатии — сканирование. При нажатии вместе с кнопкой ПЕРЕДАЧА передается сигнал тревоги	шаг канала	включения зуммера перехода на приём
ВНИЗ "DOWN"	уменьшение частоты или канала. При длительном нажатии — сканирование. При нажатии вместе с кнопкой ПЕРЕДАЧА передается сигнал тревоги	изменение частоты тона	выключение зуммера перехода на приём
ВЫЗОВ "CALL"	вызывной канал	включение-выключение звонка	тревоги ◀▶ 1750Гц
СКАН. "SCAN"	сканирование с кнопкой ПЕРЕДАЧА, большой/малую (Low) мощности	установка сдвига	
ПОДСВЕТКА "LAMP"	включение-выключение подсветки дисплея	отключение автовыключателя	изменение режима подсветки дисплея

■ DJ-S41 UHF 手持台使用方法

按 键	单独按下	与 F 键一起使用	按下并开启电源
F	瞬息间的按下即改变频数位		重置
MONI	声听	锁键 / 开放锁键	Beep 声开 / 关
PTT	发射		
V/M	VFO 与记忆信道转换	编写记忆信道: 使用 UP/DOWN 键 信道选择后, 再按 V/M 键	信道显示与频率显示互换
UP	1. 频率与信道上升 2. 长按为扫描功能 3. 与 PTT 一起使用发呼叫震铃讯号	编频步进级数	Beep 声守候开启
DOWN	1. 频率与信道下降 2. 长按为扫描功能 3. 与 PTT 一起使用发呼叫震铃讯号	CTCSS 语音频设定	Beep 声守候开启
CALL	呼叫信道	警号开 / 关	转响与 1750Hz 引导译号互换
SCAN	扫描 与 PTT 一起使用发射输出 互换高 / 低 (Low)	发射移频设定	
LAMP	夜光显示开 / 关	自动关机设定	改变夜光显示模式

■ MODE D'EMPLOI

Touche	Pressez seulement	Maintenez F et pressez	Maintenez la touche et remettez l'appareil
F (fonction)	Pressez pour l'instant, pour changer la fréquence en digit de 1MHz		Reinitialisation (Reset)
MONI	Ouvrir le squelch pour écouter les signaux faibles	Verrouillage	désactiver/activer Bip
PTT	émitter		
V/M	VFO (commande crantée) ← → Mémoire	Mise en mémoire: choisir le canal par UP/DOWN, et appuyer V/M encore.	mode d'affiche Nr. de Canal
UP	fréq./mém. vers en haut (balayage si maintenu). Si pressée avec PTT, émettra sono d'alerte.	pas des canaux	activer le bip de commence d'écoute
Down	fréq./mém. vers en bas (balayage si maintenu) Si pressée avec PTT, émettra sono d'alerte.	Sélection des tons CTCSS pour codage	désactiver le bip de commence d'écoute
CALL	canal "C"	activer/désactiver l'alarme	changer entre ton-alert et 1750Hz
SCAN	commence balayage (scan start). Avec PTT, changer la puissance Haut (Hi)/Bas (Low).	Décalage relais	
LAMP	éclairer le LCD	Arrêt automatique (APO)	changer chronograph de la lampe

■ OPERACION BASICA

teclado	pulse solamente	empuje cuando F está empujado	empujado este teclado, enciende el radio
F (Función)	Pulse rápidamente para cambiar la frecuencia en digit de 1MHz		re-inicio
MONI	abrir el squelch para escuchar los señales debiles	bloqueo/libre de teclado	tonos de aviso desactivar/activar
PTT	Transmitir		
V/M	VFO (Dial por sintonizar) ← → Memoria	programe la mem.: Elige CH por UP/DOWN, y empuje V/M otra vez.	modo de indicación del nro. de canal
UP	aumentar el Nr. de frec./mem. (cuando empujado por segundos y si empujado con PTT, transmite el tono de alerta)	paso de sintonía	activer el tono de sintonía
Down	disminuye el Nr. de frec./mem. (cuando empujado por segundos y si empujado con PTT, transmite el tono de alerta)	Selección de subtonos CTCSS	desactiver el tono de sintonía
CALL	canal "C"	activer/desactiver el alarma	cambio tono-alerta/1750Hz
SCAN	comenzar barrido (scan). Con PTT, cambio potencia de salida Hi (Alta)/Low (Baja)	frecuencia de desplazamiento (off-set)	
LAMP	iluminar la pantalla LCD	desconexión automática (APO)	cambio tiempo por iluminar

El mercado CE que aparece en los productos indica que se han certificado de acuerdo con la Directiva EMC 89/336/CEE y la Directiva sobre Bajo Voltaje 73/23/CEE, en los casos en los que les sea aplicable. Los productos satisfacen la Normativa de Compatibilidad Electromagnética: EN 50081, Normativa General sobre Emisiones y Compatibilidad Electromagnética; EN 50082, Normativa General sobre Inmunidad.

CPU Unit

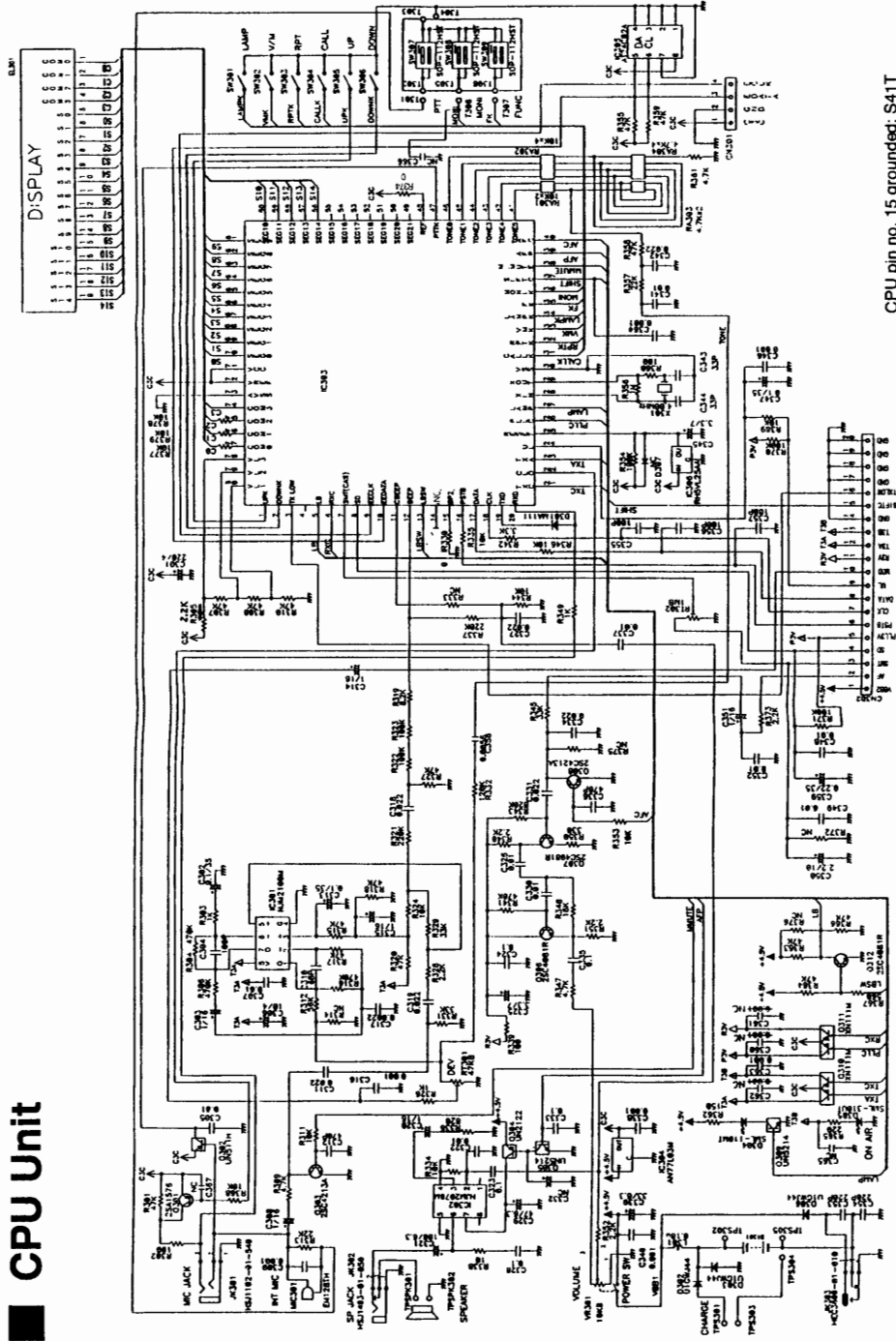

CPU pin no. 15 grounded: S41T
CPU pin nos. 14 & 15 grounded: S41(C)

RF Unit

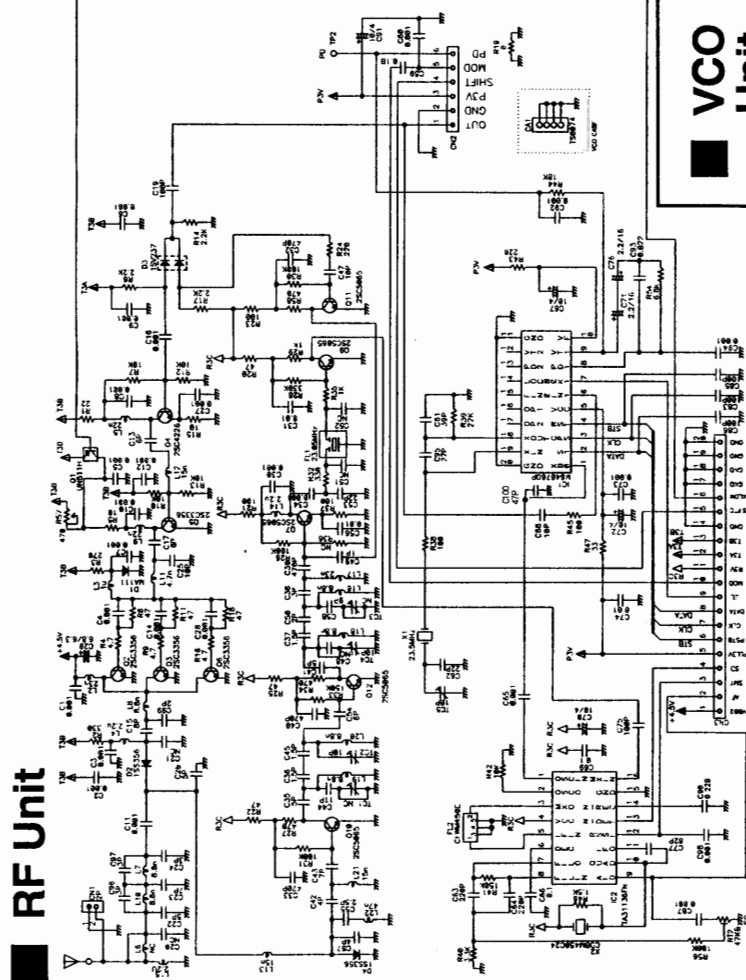

NOTE: This equipment has been tested and found to comply with the limits for a Class B digital device, pursuant to part 15 of the FCC Rules. These limits are designed to provide reasonable protection against harmful interference in a residential installation. This equipment generates, uses, and can radiate radio frequency energy and, if not installed and used in accordance with the instruction manual, may cause harmful interference to radio communications. However, there is no guarantee that interference will not occur in a particular installation. If this equipment does cause harmful interference to radio or television reception, which can be determined by turning the equipment off and on, the user is encouraged to try to correct the interference by one or more of the following measures:

- Reorient or relocate the receiving antenna.
- Increase the separation between the equipment and receiver.
- Connect the equipment into an outlet on a circuit different from that to which the receiver is connected.
- Consult the dealer or an experienced radio/TV technician for help.

VCO Unit

