

# ALINCO

## WIDE RANGE SCANNING RECEIVER

# DJ-X2000

## Instruction Manual

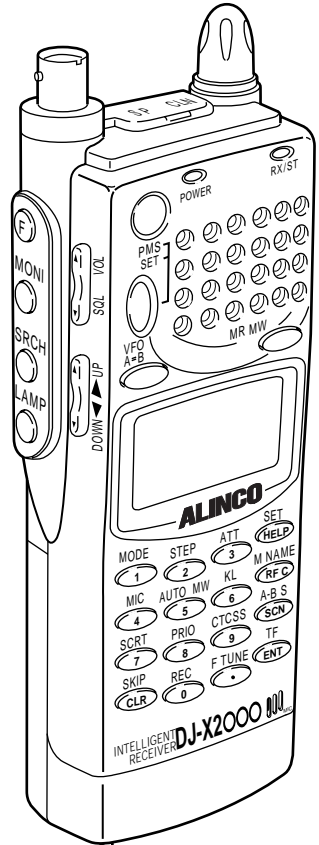

Thank you for purchasing this ALINCO receiver. The DJ-X2000 instruction manual contains important safety and operating instructions. Read this manual carefully before using the product.

# Features

The Alinco DJ-X2000 is a professional multifunctional receiver which covers a wide band of radio media from the low-frequency band (LF) to ultrahigh-frequency (UHF) band. It has the following features:

- 1. Wide frequency range** The DJ-X2000 covers a wide frequency range from 0.1 to 2149.999950 MHz.
- 2. Three operating modes** The DJ-X2000 has three basic operating modes: Dual VFO, Memory (MR), and Scan Programming (PMS). The modes can be switched by one-touch operation.
- 3. LARGE Memory capacity** Memory function allows you to program up to 2000 channels. (40 ch × 50 banks)
- 4. Scanning** Various kinds of scanning are available: Program scan (PMS), Memory scan, Mode-select scan, VFO scan, VFO-linked scan, and Priority scan.
- 5. 20 scan programs** The PMS mode has a total of 20 programmable bands.
- 6. Channel Scope™** The search function checks frequencies in set frequency steps and displays signals within a 40-channel or 7-channel range at one time.
- 7. Battery-save function** The battery-save function automatically saves battery power whenever keys are not used or a signal is not picked up for a certain amount of time.
- 8. Cloning** You can copy the settings stored in memory from one DJ-X2000 to another. Moreover, you can connect the DJ-X2000 to a personal computer and copy the settings.
- 9. All mode reception** You can select a modulation mode from AM, NFM, WFM, LSB, USB, CW, and AUTO. When AUTO is selected, the DJ-X2000 automatically determines the most suitable modulation mode for the currently received frequency.
- 10. Channel step** Channel step is selectable from 23 fixed steps, or you can choose any step between 50 Hz - 500 kHz. In addition, the DJ-X2000 determines the most suitable channel step for the currently received frequency when AUTO is selected.



**11. Frequency editing**

You can copy the content of one memory channel to another, or rename memory channels.

**12. Transweeper™**

The DJ-X2000 detects a listening microphone which transmits a radio wave from a hidden transmitter. If a listening microphone is found, the DJ-X2000 will alert you with a display and warning sound.

**13. Recording function**

The DJ-X2000 records the sound of a currently received signal or sound from the microphone, and replays it. The maximum recording time is 160 seconds.

**14. Descrambler**

The DJ-X2000 can return scrambled voice transmission to normal voice reception.

**15. Flash tune**

If there are signals around the DJ-X2000, it tunes to the strongest frequency in a flash.

**16. RF checker**

This function allows you to use the DJ-X2000 as a radio frequency counter.

**17. Electric field strength meter**

The DJ-X2000 can measure relative electric field strength and indicate it on the display.

**18. Directional microphone**

The built-in microphone picks up sound and amplifies it.

**19. Receives FM radio in stereo**

The DJ-X2000 receives stereo FM when stereo headphones are used.

**20. CTCSS decoder**

The DJ-X2000 decodes CTCSS tones.

**21. A/B squelch**

This function cancels the squelch when there is no modulation signal of 2300Hz.

**22. Help-navigator**

The Help-navigator displays how to use each function of the DJ-X2000. Moreover, you can jump to setting the currently displayed function from the help menu, and execute the function.

**23. Exceedingly sensitive antenna for HF and MF**

Newly developed antenna is included.

**24. DC switching power supply**

DC switching power supply conserves battery power.

**25. 2-level attenuator**

High (20 dB) and Low (10 dB) attenuators are included.

# Contents

<b>Features</b>	<b>1</b>
<b>Contents</b>	<b>3</b>
<b>How to read this manual</b>	<b>6</b>
<b>1. Before use</b>	<b>7</b>
<b>1.1 Unpacking the receiver</b>	<b>7</b>
<b>1.2 Precautions in use</b>	<b>7</b>
<b>1.3 Names of parts and their functions</b>	<b>8</b>
1.3.1 Top, front and left side panels	8
1.3.2 Rear and right panels	10
1.3.3 Display	11
1.3.4 Key pad	12
<b>1.4 Setting up the DJ-X2000</b>	<b>13</b>
1.4.1 Attaching the antenna	13
1.4.2 Attaching the belt clip	13
1.4.3 Attaching the wrist strap	13
<b>1.5 About the batteries</b>	<b>14</b>
1.5.1 Attaching the battery pack	14
1.5.2 About the battery pack	15
1.5.3 Ni-Cd battery charger	16
1.5.4 Battery low alarm	18
<b>2. Basic operations</b>	<b>19</b>
<b>2.1 POWER switch</b>	<b>19</b>
<b>2.2 Volume control</b>	<b>19</b>
<b>2.3 Squelch control</b>	<b>20</b>
<b>2.4 Setting frequency</b>	<b>20</b>
<b>2.5 Switching frequency band</b>	<b>22</b>
<b>2.6 Copying frequencies from one band to the other</b>	<b>22</b>
<b>2.7 Scanning</b>	<b>22</b>
<b>2.8 Searching(Channel Scope™)</b>	<b>23</b>
<b>2.9 Monitoring(Squelch OFF)</b>	<b>24</b>
<b>2.10 Turning backlight ON/OFF</b>	<b>25</b>
2.10.1 Turning backlight ON/OFF manually	25
2.10.2 Turning backlight ON/OFF based on the setting	25



<b>2.11 Turning beep ON/OFF</b> .....	<b>26</b>
<b>2.12 Locking/Unlocking</b> .....	<b>27</b>
<b>2.13 Setting the clock</b> .....	<b>27</b>
2.13.1 Setting the OFF timer .....	27
2.13.2 Setting the ON timer .....	28
<b>2.14 Basic modes</b> .....	<b>29</b>
2.14.1 VFO mode .....	29
2.14.2 PMS mode .....	30
2.14.3 MR mode.....	30
<b>2.15 Using HELP menu</b> .....	<b>31</b>
<b>3. Other Useful Functions</b> .....	<b>32</b>
<b>3.1 Functions common to all modes</b> .....	<b>32</b>
3.1.1 Selecting a modulation mode .....	32
3.1.2 Setting the frequency step.....	32
3.1.3 Attenuating interference from other channels(ATT) .....	33
3.1.4 Battery Save .....	34
3.1.5 Copying data between two receivers(CLONE) .....	35
3.1.6 Selecting a communication speed .....	36
3.1.7 Selecting a language mode .....	37
3.1.8 Field-strength meter .....	37
3.1.9 Displaying battery voltage .....	39
3.1.10 Setting the reception tone .....	39
3.1.11 Selecting the BELL mode.....	40
3.1.12 Changing the initial message .....	40
3.1.13 Resetting the receiver .....	41
3.1.14 Tuning in frequencies in the PMS/MR modes(M.TUNE) .....	42
3.1.15 Setting scan resume condition(SCAN MODE) .....	42
3.1.16 Setting scan signal level .....	43
3.1.17 Setting the scanning pause period .....	44
3.1.18 Turning the priority function ON/OFF .....	45
3.1.19 Selecting a priority option .....	45
3.1.20 Setting a priority channel .....	46
3.1.21 Specifying a priority interval .....	47
3.1.22 Setting search resume condition(SRCH MODE) .....	48
3.1.23 Flash tune .....	49
3.1.24 Descrambler .....	51
3.1.25 CTCSS decoding function .....	52



3.1.26 A/B squelch .....	54
3.1.27 Transweeper™ .....	55
3.1.28 Recording function .....	57
3.1.29 Sound pickup .....	59
3.1.30 Directly changing the settings.....	60
<b>3.2 Functions in the VFO mode .....</b>	<b>61</b>
3.2.1 VFO link function .....	61
3.2.2 Scanning between VFO's A and B(AB SCAN) .....	62
3.2.3 Copying frequencies from memories to the VFO .....	62
3.2.4 Copying frequencies from the PMS mode to the VFO .....	63
<b>3.3 PMS mode functions .....</b>	<b>64</b>
3.3.1 Programmed scan operations .....	64
3.3.2 Setting scan pass-frequency.....	65
3.3.3 Setting program link .....	66
3.3.4 Copying scan programs.....	66
3.3.5 Moving a scanning program .....	67
3.3.6 Deleting scan programs.....	68
<b>3.4 MR mode functions .....</b>	<b>69</b>
3.4.1 Memorizing frequencies .....	69
3.4.2 Setting the auto memory write function .....	70
3.4.3 Setting memory scan skip .....	70
3.4.4 Setting memory scan radio system(MODE SEL) .....	71
3.4.5 Using the Bank Link function.....	72
3.4.6 Selecting memory channels for scanning .....	72
3.4.7 Scanning the memory channels selected in the PMR screen .....	74
3.4.8 Copying memory banks .....	74
3.4.9 Copying memory channels .....	75
3.4.10 Moving a memory bank .....	76
3.4.11 Moving a memory channel .....	77
3.4.12 Deleting memory banks .....	79
3.4.13 Deleting and restoring memory channels.....	80
3.4.14 Searching for a memory tag .....	81
<b>4.Appendix.....</b>	<b>82</b>
<b>4.1 Specifications .....</b>	<b>82</b>
<b>4.2 Troubleshooting .....</b>	<b>83</b>
<b>4.3 Optional items .....</b>	<b>83</b>
<b>4.4 List of Help menu items .....</b>	<b>84</b>

# How to read this manual

The following typographical and graphic conventions are used in this instruction manual.

**Bold typeface** indicates titles of chapters and sections as well as messages shown on the display.

When used to indicate displayed messages, only the part of the message that is pertinent to the explanation is given. Actual messages may however contain more characters.

Plain typeface text enclosed in " " indicates sections in this instruction manual you should refer to for further information. Only in a few cases are quotation marks used to identify terminology.



*CAUTION:* The caution icon contains information which, if ignored or not followed correctly, could result in product damage. Always read and observe these items.



*Note:* The note icon contains additional information pertinent to product use, which is helpful but not necessarily known.

# 1. Before use

## 1.1 Unpacking the receiver

The DJ-X2000 should come with the following accessories. Check that nothing is missing when you first open the package.

- Antenna (EA-94) × 1
- Charger (EDC-88) × 1
- Ni-Cd battery pack (EBP-37N) × 1
- Belt clip with two screws (EBC-3) × 1
- Wrist strap × 1
- DJ-X2000 Instruction Manual (This manual) × 1

Standard accessories may differ depending on the version.

## 1.2 Precautions in use

- Do not use or store the receiver in dusty places, where exposed to direct sunlight, near sources of heat, or in other adverse environments.
- Attach the included antenna securely to the receiver.
- Use only the EDC-36 car lighter cable (with active filter) to draw power from an automobile.
- If the receiver emits smoke or strange odors, shut power OFF immediately and promptly contact an authorized dealer.
- Do not disassemble or tamper with the receiver. The DJ-X2000 is not warranted for troubles or accidents resulting from unauthorized modifications, regardless of the warranty period. Alinco dealer also reserves the right to refuse to service the receiver in such event.
- Obtain approval from the proper authorities before using this receiver on board aircraft or in hospitals.
- Do not use 9.6 V or higher voltage batteries (e.g. EBP-36N).



# 1.3 Names of parts and their functions

This section describes parts by name and function.

## 1.3.1 Top, front and left side panels

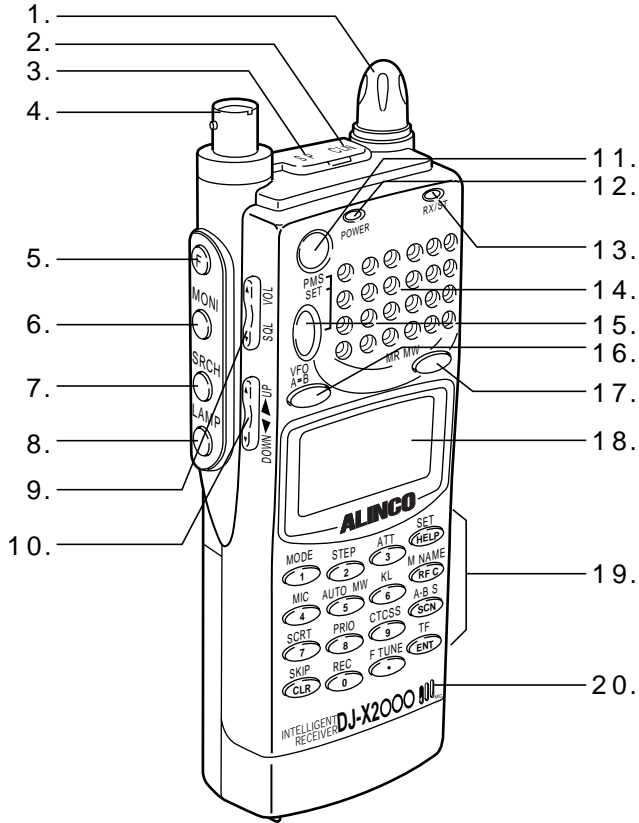

- 1. Dial** Use to switch frequency and memory channel, to adjust the audio volume and squelch level, and to make other settings.
- 2. CLN terminal** Use to clone settings between two DJ-X2000s, and to connect with the PC editor.
- 3. SP terminal** Connect an external speaker with amplifier or earphone here. Stereo FM radio can be received in stereo when stereo speakers or stereo earphones are connected.
- 4. Antenna connector** BNC connector. Attach the included antenna here.

5. **F (Function) key** Use this key in combination with other keys to call up specific functions.
6. **MONI key** Temporarily cancels the squelch for the duration it is held down. Used independent of squelch level.
7. **SRCH key** Press to start scanning within a 40-channel range. Use in combination with **F** key to start scanning in a 7-channel range.
8. **LAMP key** Turns the key backlight ON/OFF.
9. **VOL/SQL key** Use to adjust the audio volume and squelch level.
10. **UP/DOWN key** Use to set frequency, to adjust the audio volume and squelch level, to control various settings, and to select an item in the menu display.
11. **POWER switch** Turns power ON/OFF.
12. **Hardware reset key** Press to reset all functions to their factory-settings. However, data stored in memory is not deleted. Settings might return to the settings when power was turned ON the last time.
13. **Busy lamp** Lights green when a signal is picked up and stays lit while the signal is active. Lights orange when receiving FM radio in stereo (using stereo earphones). In Transceiver mode, lights red while transmitting.
14. **Speaker** Sound is produced from here.
15. **PMS SET key** Shifts to the scan programming mode. If pressed in combination with the **F** key, the scan program can be saved in memory.
16. **VFO A=B key** Engages the dual VFO mode. If pressed in combination with the **F** key, the frequency displayed in the top band is copied to the bottom band.
17. **MRMW key** Use to access the memory. If pressed in combination with the **F** key, frequencies and other data can be saved in memory.
18. **Display** Displays frequency, operating status and other information pertinent to use.
19. **Key pad** In the VFO mode, use these keys to directly input the frequency you want. Press in combination with the **F** key to access other functions.
20. **Built-in microphone** Use to pick up sound and record it.



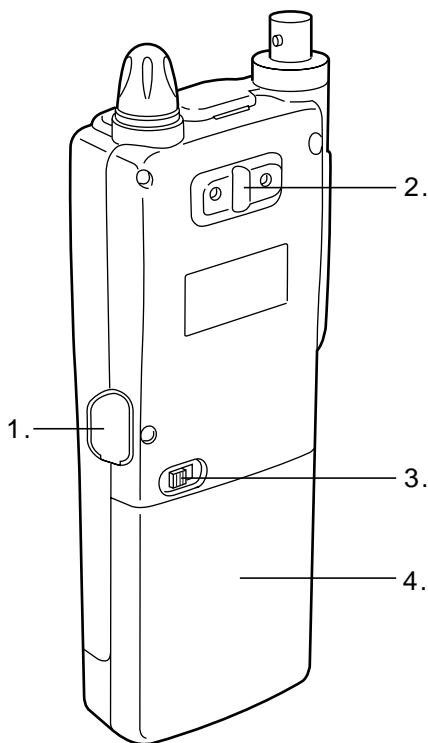



## 1.3.2 Rear and right panels

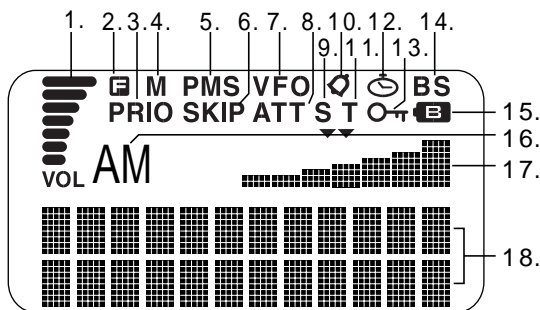

















- 1. DC-IN**                      Connect an external DC supply here (10 - 16 V).
- 2. Holes for attaching belt clip**                      Screw the included belt clip to the DJ-X2000 here.
- 3. Battery case lock**                      Slide to the right to detach the battery case.
- 4. EBP-37N battery pack or dry cell case**                      The dry cell case can hold four AA batteries.

## 1.3.3 Display



- |  |  |
|--|--|
| <p>1.  VOL</p> <p>2.  F</p> <p>3. <b>PRIO</b></p> <p>4. <b>M</b></p> <p>5. <b>PMS</b></p> <p>6. <b>SKIP</b></p> <p>7. <b>VFO</b></p> <p>8. <b>ATT</b></p> <p>9. <b>S</b></p> <p>10.  B</p> <p>11. <b>T</b></p> <p>12.  T</p> <p>13.  K</p> <p>14. <b>BS</b></p> <p>15.  B</p> <p>16. <b>AM</b></p> <p>17. <b>S-meter</b></p> <p>18. <b>Dot-matrix display</b></p> | <p>Meter for displaying sound level.</p> <p>Displayed when the  key has been pressed to indicate that you can access the subfunctions of the keys.</p> <p>Displayed while the priority function is ON.</p> <p>Displayed in the MR mode.</p> <p>Displayed in the PMS mode.</p> <p>Displayed for memory channels which are skipped in memory scans. Skip is user-set.</p> <p>Displayed in the VFO mode.</p> <p>Displayed when the attenuator is ON.</p> <p>Displayed when a frequency indivisible by the set frequency step is entered.</p> <p>Displayed when the bell function is ON.</p> <p>Displayed when the CTCSS decoder is ON.</p> <p>Displayed when On-timer or Off-timer is ON.</p> <p>Displayed while keys are locked.</p> <p>Displayed when the battery-save function is ON.</p> <p>Displayed when battery power is low. Promptly replace the batteries if this icon is displayed.</p> <p>Modulation mode is displayed. When the audio volume or squelch level is being adjusted, either of them is displayed.</p> <p>S-meter. Depending on settings, the time or the Channel Scope™ setting is also displayed here.</p> <p>This is where band, channel name and frequency are displayed in the various modes.</p> |
|--|--|

## 1.3.4 Key pad

1.  Inputs **1**. Press in combination with the **F** key to switch the modulation mode.
2.  Inputs **2**. Press in combination with the **F** key to set the frequency step.
3.  Inputs **3**. Press in combination with the **F** key to turn the attenuator ON/OFF.
4.  Inputs **4**. Press in combination with the **F** key to turn the directional microphone function ON.
5.  Inputs **5**. Press in combination with the **F** key to turn the auto memory write function ON/OFF.
6.  Inputs **6**. Press in combination with the **F** key to lock/unlock keys.
7.  Inputs **7**. Press in combination with the **F** key to set the Descrambler.
8.  Inputs **8**. Press in combination with the **F** key to turn the priority function ON/OFF.
9.  Inputs **9**. Press in combination with the **F** key to set the CTCSS decoder.
10.  Clears settings. In VFO mode, press in combination with the **F** key to set VFO-link. In PMS and MR modes, press in combination with the **F** key to set the scan pass frequency and skip channel.
11.  Inputs **0**. Press in combination with the **F** key to turn the recording function ON.
12.  Inputs **•** (decimal point). Press in combination with the **F** key to set the Flash tune function.
13.  Press to call up the Help-navigator. Press in combination with the **F** key to call up menus.
14.  Press to turn the RF checker ON. Press in combination with the **F** key to turn the Memory search function ON.
15.  Starts scanning. Press in combination with the **F** key to scan between band A and band B.
16.  Enters input values. Press in combination with the **F** key to turn the Transweeper ON.

## 1.4 Setting up the DJ-X2000

Before using your receiver, attach the included antenna securely. If you want to use the belt clip or wrist strap, attach them too.

### 1.4.1 Attaching the antenna

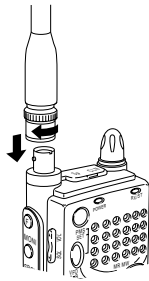

Fit the base of the antenna over the projections on the connector, press downward and turn clockwise. Check to be sure the antenna is securely attached.

### 1.4.2 Attaching the belt clip

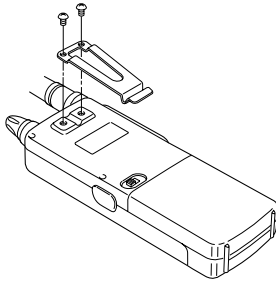

Screw the belt clip onto the rear panel (screws x 2). Check to be sure the clip is securely attached before use.

### 1.4.3 Attaching the wrist strap

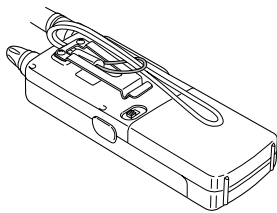

Fit the wrist strap under the belt clip and pull it through its own loop.

## 1.5 About the batteries

### 1.5.1 Attaching the battery pack

- To detach the battery pack

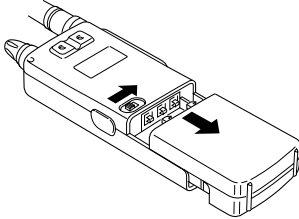

Slide the battery pack lock on the case to the right and pull the case downward to detach.

- To attach the battery pack

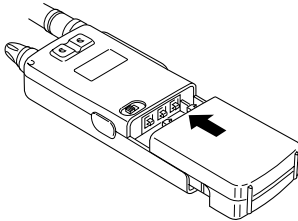

Fit the battery pack into the holes on the DJ-X2000 and push in the direction of the arrow until the case snaps into the place.

## 1.5.2 About the battery pack

Before using the included EBP-37N battery pack, please note the following:

1. The battery pack is not charged before it is shipped from the factory. Charge the pack before using the DJ-X2000 for the first time.
2. Approximately 1 hour is required to fully charge the battery pack with the charger.
3. Charge batteries only in temperatures from 0°C to 40°C (32°F~104°F).
4. DANGER! Do not disassemble, tamper with, heat or wet the battery pack.
5. Do not short-circuit battery pack terminals. This can generate heat inside the pack resulting in burns and/or damage to the pack.
6. Do not overcharge the battery pack. Overcharging can lead to battery performance loss.
7. Store the battery pack in a cool, dry place where temperature is between -20°C and 45°C(-4°F~113°F). Environments outside this range can cause battery acid to leak and metal parts to rust.
8. The battery pack can be fully recharged approximately 300 times. When a fully charged battery pack lasts considerably less than expected, it is time to replace it with a fresh pack.
9. Do not throw away dead Ni-Cd battery packs. They can be recycled. Give them to stores which accept old batteries.
10. Do not charge an unexhausted battery pack repeatedly. It may shorten the operating time of a battery pack.

### • To prevent battery pack short-circuiting

When carrying the battery pack, be extremely careful not to short-circuit the terminals. If short-circuited, the high surge in current could heat up the pack, resulting in burns or fire.

1. Keep the battery pack away from metal objects such as necklaces, etc.
2. Do not keep the battery pack inside bags with metal-plated linings or wrap it in handkerchiefs with metallic thread or print.
3. Do not leave the battery pack in proximity of electro-conductive materials or metal objects such as nails or chains.
4. Place the battery pack in an electrically-insulated bag or wrap it in a handkerchief before putting it in your handbag, etc.
5. Place the battery pack on an electrically-insulated mat when setting it on a flat surface.



## 1.5.3 Ni-Cd battery charger

The supplied battery charger (EDC-88) is designed exclusively for use with our NiCd battery pack.

### Precautions in using the charger

1. The battery charger is designed exclusively for use with our NiCd battery pack. Never use it to recharge any other rechargeable battery or dry cell.
2. Do not use the battery charger as a power source for any appliance.
3. Do not disassemble the battery charger.
4. Do not put any metal piece or wire in the battery charger, nor short-circuit the recharging terminals.
5. Do not use the battery charger in a location where the temperature rises high, e.g., near a heater or under direct sunlight, or where the dust or humidity level is high.

### • Parts designation and function

#### ① Lamp

Indicates the status of the battery charger.

Lamp status	Battery charger status	Handling the battery pack
Illuminated in red	Quick recharge is in progress.	Leave it until it has been recharged completely.
Illuminated in green	Supplemental recharge is in progress.	It may be removed.
Blinking in green	Supplemental recharge is completed.	Remove it.
Blinking in red	Supplemental recharge is in progress for the completely discharged battery pack.	Leave it until it has been recharged completely.
Blinking alternately in red and green	An irregular battery pack is in place.	Remove it immediately.

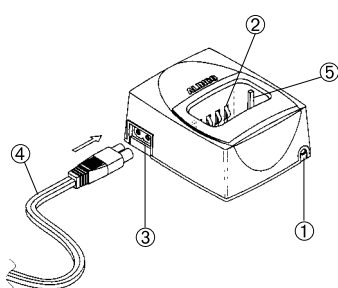

#### ② Recharging terminals

Used for recharging the battery pack.

#### ③ AC power socket

Used to plug the AC power cord.

#### ④ AC power cord

Used to supply AC power.

#### ⑤ Guides (on the right and left sides)

Used to guide the transceiver when inserting it into the battery charger.

## • Recharging procedure

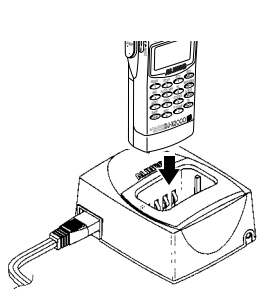

- 1** Plug the AC power cord into the AC power socket on the battery charger.
- 2** Insert the battery pack being recharged, along the guides provided on both sides of the battery charger. The lamp will be illuminated in red, and quick recharge will be started.
- 3** When the quick recharge is completed, the lamp changes its color to green, indicating that supplemental recharge (\*) has started.
- 4** About four hours after the quick recharge has started, the lamp starts blinking in green, indicating that the supplemental recharge has been completed.



*Note: The supplemental recharge means recharging the battery pack with a small electric current to prevent its capacity from decreasing due to the self-discharge. This does not overcharge the battery pack.*

## • Battery pack vs. recharging time

The battery packs applicable to each battery charger model and their recharging time are shown below:

Battery pack	Battery capacity	Recharging time
EBP-33N	4.8V 650mAh	Approx. 1 hour
EBP-34N	4.8V 1200mAh	Approx. 1.5 hours
EBP-35N	7.2V 900mAh	Approx. 1.2 hours
EBP-37N	4.8V 700mAh	Approx. 1 hour
EBP-47N	7.2V 700mAh	Approx. 1 hour

### Precautions in recharging

1. Ensure that the transceiver is OFF when recharging the battery pack. The use of the transceiver during recharging can cause the transceiver to malfunction.
2. The battery charger is designed to be used at an ambient temperature between 10°C and 40°C (50°F and 104°F). Avoid recharging the battery pack at any temperature outside this range.
3. Do not repeatedly recharge a fully recharged battery pack. This can cause the performance of the battery pack to deteriorate. The battery pack can be recharged up to 300 times when it is used normally. If the life of the completely recharged battery pack becomes markedly shorter, the battery pack is considered to have been exhausted. Please purchase a new battery pack.
4. Do not insert the battery pack in a reverse direction.
5. When the battery pack has been recharged completely, with the lamp blinking green, remove the battery pack from the battery charger.
6. If the battery charger is not used for a long period of time, disconnect the AC power cord from the wall socket, and remove the battery pack from the battery charger.
7. If you recharge a battery pack of which voltage has abnormally dropped due to discharge, the lamp starts blinking red and a preliminary recharge initiates immediately after you have started recharging the battery pack. Subsequently, the lamp will be illuminated red, indicating that the quick recharge has started.
8. If any irregular battery pack is set in place, the lamp will blink alternately in red and green.

## 1.5.4 Battery low alarm

When batteries get low, the  icon appears on the display to the sound of a repeated siren-like alarm.

Change the batteries as soon as possible.

However, the alarm is not emitted if the beep function is turned OFF.

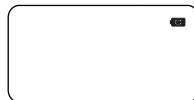

*Note: If you use the DJ-X2000 with the exhausted batteries being mounted in a state of unable to turn on the power switch. It may become unable to accept any external power. If the DJ-X2000 will not start even when you press the power switch, press the hardware reset key or detach the battery case more than 10 seconds before connecting any external power.*

## 2. Basic operations

This chapter describes the basic operations for the DJ-X2000.

### 2.1 POWER switch

To turn ON/OFF the DJ-X2000, perform the following operation:

#### • Turning ON

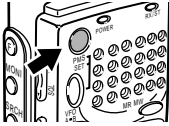

Hold down the POWER switch for approx. 1 second until the message "ALINCO INTELLIGENT RECEIVER™" appears on the display.

#### • Turning OFF

Hold down the POWER switch until the display goes out.



*Note:* The message that appears on the display may be changed (see "3.1.12 Changing the initial message" on page 40).

### 2.2 Volume control

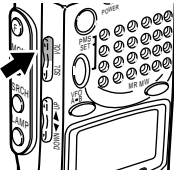

To turn up the volume, press the **VOL** key located on the left side of the body, and then press the **UP** key or turn the dial clockwise. To turn down the volume, press the **VOL** key, and then press the **DOWN** key or turn the dial counterclockwise.

The  bars on the display will increase/decrease with the adjacent number changed between V00 and V32 as you control the volume.

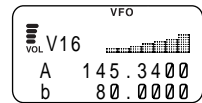

*Note:* To disengage the squelch (the mute function) temporarily, press and hold the  key on the left panel. This will enable you to set the volume setting without changing the squelch setting (see "2.3 Squelch control" page 20).

## 2.3 Squelch control

Squelch is used to mute the speaker noise when no signal is being received. Squelch level can be selected between S00–S32. Setting is made as follows. A squelch level can be selected from the range between S00 and S32.

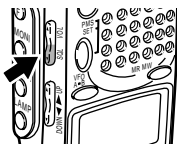

To select a squelch level, press the **SQL** key located on the left side of the body, and then press the **UP/DOWN** key or turn the dial. The squelch level will be shown on the display in accordance with the setting.

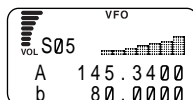

- Note:**
- Higher squelch levels require higher signal levels to release the muting. Set the squelch to a level at which the noise just disappears.
  - The level at which to release the muting varies depending on the received frequency even if the electric field strength remains the same. Adjust the squelch at the most suitable level for the frequency to be received.
  - If the squelch level is too high, weak incoming signals may not be heard from the speaker.

## 2.4 Setting frequency

Frequency can be set in any of four ways: By using the numeric keys, the UP/DOWN key, the dial, or the combination of the **F** key and the dial.

### • Setting by numeric keys

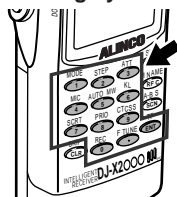

Input the frequency directly from the numeric keys and then press the **ENT** key.

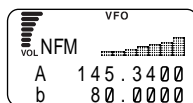

**Example 1** To set 145.3400 MHz, press the **MODE** **1**, **MIC** **4**, **AUTO MW** **5**, **F TUNE** **.**, **ATT** **3**, **MIC** **4**, and **TF ENT** keys in the given order.

The **00** on the end can be omitted.

**Example 2** To set 0.5580 MHz (that is, 558 kHz), press the **REC** **0**, **F TUNE** **.**, **AUTO MW** **5**, **AUTO MW** **5**, **PRIO** **8**, and **TF ENT** keys in the given order.

The **0** on the end can be omitted.



Note: If you enter any frequency that cannot be divided by the set frequency step, "S" appears on the display.

### • Setting with the UP/DOWN key

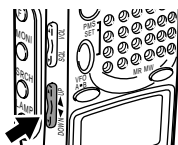

For higher frequencies, press the **UP** key. For lower frequencies, press the **DOWN** key. The frequency will increase/decrease in the set frequency steps.



Note: For changing the frequency step, see "3.1.2 Setting the frequency step" (page 32).

### • Setting from the dial

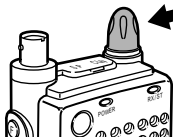

For higher frequencies, turn the dial clockwise. For lower frequencies, turn it counterclockwise. The frequency will increase/decrease in the set frequency steps.



Note: For changing the frequency step, see "3.1.2 Setting the frequency step" (page 32).

### • Setting with the combination of the **F** key and the dial

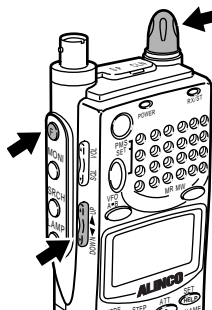

Press the **F** key, and then press the **UP/DOWN** key while **F** is shown on the display. An under-bar will appear at the digit of 100, 10, or 1 MHz. Now turning the dial allows you to change the number at that digit. Pressing the **UP/DOWN** key shifts the digit at which the number can be changed.

## 2.5 Switching frequency band

The DJ-X2000 uses a dual VFO system, so that a frequency change can be done smoothly by inputting a new frequency on the second band in advance. The frequency currently being monitored is displayed next to the capital letter on the top line of the display. Frequency band can be switched as follows.

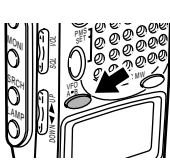

Press the **VFO** key. The frequencies on the top and bottom lines will switch places, with the letters changing between capital and lower case.

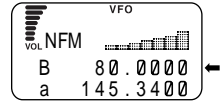

## 2.6 Copying frequencies from one band to the other

The frequency on the currently used band can be copied into the other band as follows.

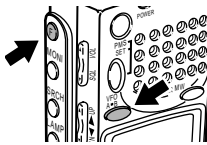

Press the **F** key, and then press the **VFO** key while **F** is shown on the display.

This will copy the frequency on the currently used band (displayed on top line next to capital letter) into the other band (displayed on bottom line next to small case letter).

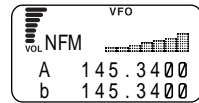

## 2.7 Scanning

Scanning is used to locate frequencies with signals present. Basic scanning operations are as follows.

### • To scan

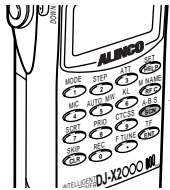

Press the **A-B S (SCN)** key. Scanning will start and will proceed in the set frequency steps.

While scanning, an arrow icon is displayed next to the frequency on currently used band (displayed on top line next to capital letter). The arrow points to the left while scanning towards the higher frequencies.

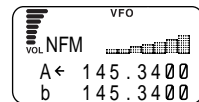

*Note:* If CTCSS or A/B Squelch is selected, the scan may be delayed since it takes some time to match the selected parameters.

If live frequencies are received, scanning is temporarily stopped. To resume scanning, turn the dial or press the **UP/DOWN** key. Scanning can be automatically resumed by specifying scan resuming conditions. For further details, see "3.1.15 Setting scan resume condition (SCAN MODE)" (page 42).

• **To switch scanning direction**

While scanning, press the **DOWN** key. The arrow icon will face right and scanning will proceed toward the lower frequencies. To scan toward the higher frequencies, press the **UP** key. The scanning direction can also be changed by turning the dial.

• **To cancel scanning**

Press the  key again.

## 2.8 Searching (Channel Scope™)

The search function, or Channel Scope of the DJ-X2000 checks frequencies in the set frequency steps, and displays signals within a 40-channel or 7-channel range at one time. The function is useful for checking the spectrum occupancy at a glance. It is used as follows.

• **40-channel search**

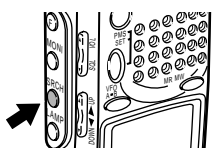

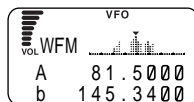

Press the  key on the left side panel. The DJ-X2000 will start searching for signals within a 40-channel range of the currently received frequency. The search proceeds in set frequency steps with the displayed frequency in the center under ▼ mark. The higher channel spectra are displayed towards the right, and the lower to the left. Vertical length of each spectrum indicates relative strength of the signals.

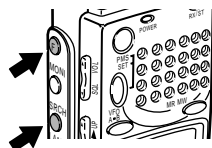

• **7-channel search**



Press the  key to display . Then, press the  key on the left side panel. The DJ-X2000 will start searching for signals within a 7-channel range of the currently received frequency. The search proceeds in the set frequency steps with the displayed frequency in the center under ▼ mark. The higher channel spectra are displayed towards the right, and the lower to the left. Vertical length of each spectrum indicates strength of the signals.

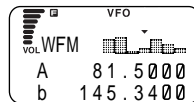



• To tune in live frequencies



To move live frequencies to the left, turn the dial clockwise or press the **UP** key. To move them to the right, turn the dial counterclockwise or press the **DOWN** key.

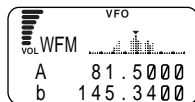

• To cancel the search

Press the  key again. This will cancel the search.





- Note:*
- For specifying search resuming conditions, see "3.1.22 Setting search resume condition (SRCH MODE)" (page 48).
  - The search resume condition factory-setting is **INTERVAL**. Sound is muted during the search. The search operation is performed every 10 seconds.
  - It may be difficult to read a value from the S meter during scanning in the Channel Scope mode, because the speed is fast.
  - The graph displayed in the Channel Scope mode is only in the range of the currently received radio type. For example, if search is performed around 76.5 MHz of WFM, no channel less than 76.0 MHz, which is NFM, is displayed.
  - If the Channel Scope mode is selected, the battery saving function is disabled.
  - If the search function is turned ON in the MR mode, it may take some time for a full display of the search.
  - If scanning is started with the search function turned ON, it may take some time to start scanning.

## 2.9 Monitoring (Squelch OFF)

The monitor function is used to pick up weak signals .

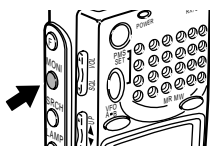



• To turn the monitor ON

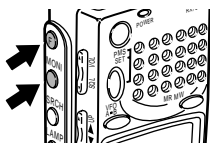

Hold down the  key. While the key is depressed, the squelch is turned OFF and weak signals can be picked up. (Noise is heard if no signal is being received.) When the  key is released, the squelch comes back ON and the DJ-X2000 returns to its original state.

• To keep the monitor ON at all times



Press the  key, and then press the  key while  is shown on the display. The squelch will remain OFF even after the  key has been released. Pressing the  key a second time will reactivate the squelch.

## 2.10 Turning backlight ON/OFF

The DJ-X2000 has a backlight to make it easier to use at night. The backlight can be turned ON/OFF as follows.

### 2.10.1 Turning backlight ON/OFF manually

#### • To turn the backlight ON

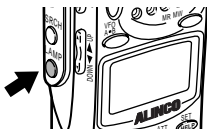

Press the **LAMP** key. The display will be lit while operating the dial or keys. Keys also light up when pressed or held down. The backlight goes OFF automatically if the controls are not used for approximately 5 seconds.

#### • To leave the backlight ON at all times

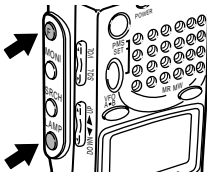

Press the **F** key, and then press the **LAMP** key while **F** is shown on the display. The backlight will remain ON until you press the **LAMP** key again.

### 2.10.2 Turning backlight ON/OFF based on the setting

The backlight can be automatically turned ON/OFF in accordance with the setting. To do so, perform the following steps:

#### 1 Call up the LAMP screen.

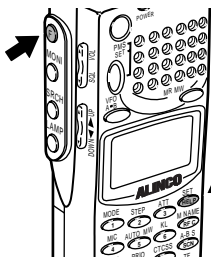

Press the **F** key, and then press the **SET/HELP** key while **F** is shown on the display. The MENU will appear. Point the arrow at **+CONFIG** using the dial or **UP/DOWN** key, and then press the **ENT** key.



The **CONFIG** menu will appear. Point the arrow at **+LAMP**, and then press the **ENT** key. The LAMP screen will appear.

## 2 Select a backlight mode as follows:

Using the dial or **UP/DOWN** key, point the arrow at a desired mode, and then press the **TF ENT** key (the initial setting is the **MOMENTARY** mode).

**AUTO:** The backlight is lit for 5 seconds after the dial or key is used.

**MOMENTARY:** The backlight remains lit only while the **LAMP** key is being held down.

**ALTERNATE:** The backlight is turned alternately **ON** and **OFF** every time the **LAMP** key is pressed.

The display will go back to the **CONFIG** menu. Point the arrow at **END**, and then press the **TF ENT** key (or alternatively, press the **F** key, and then press the **TF ENT** key with **F** shown on the display).

 *Note: If you exit the CONFIG menu by pressing the **SKIP CLR** key, the changed setting is canceled.*

## 2.11 Turning beep ON/OFF

The beep sound that is emitted when a key is pressed or a specific operation is performed can be turned **ON/OFF** and its volume can be controlled as follows:

### 1 Call up the BEEP screen.

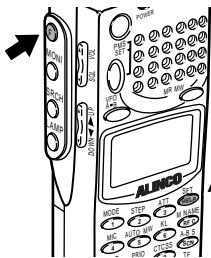

Press the **F** key, and then press the **SET HELP** key while **F** is shown on the display. The **MENU** will appear. Point the arrow at

**+CONFIG** using the dial or **UP/DOWN** key, and then press the **TF ENT** key. The **CONFIG** menu will appear.

Point the arrow at **+BEEP**, and then press the **TF ENT** key. The **BEEP** screen will appear.

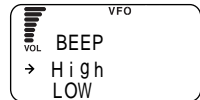

### 2 Select a beep sound mode.

Using the dial or the **UP/DOWN** key, point the arrow at a desired mode, and then press the **TF ENT** key (the initial setting is the **HIGH** mode).

**OFF:** The beep sound is turned **OFF**.

**HIGH:** The beep sound is emitted at a high level.

**LOW:** The beep sound is emitted at a low level.

The display will go back to the **CONFIG** menu. Point the arrow at **END**, and then press the **TF ENT** key (or alternatively, press the **F** key, and then press the **TF ENT** key while **F** is shown on the display.).

 *Note: • If you exit the CONFIG menu by pressing the **SKIP CLR** key, the changed setting is canceled.*

*• If stereo earphones are used, the beep sound can be heard from the left earphone only.*

## 2.12 Locking/Unlocking

This feature locks all but certain keys, preventing accidental operation of the keys. Keys can be locked/unlocked as follows.

### • To lock keys

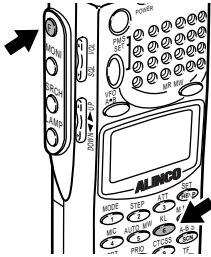

Press the **F** key, and then press the **KL 6** key while **F** is shown on the display.

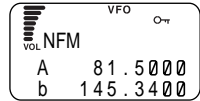

**KEY** will appear on the display and the keys will be locked except for the POWER switch, dial, and **MONI**, **VOL/SQL**, **UP/DOWN**, **F**, and **LAMP** keys.

### • To unlock keys

Again, press the **F** key, and then press the **KL 6** key while **F** is shown on the display. This will unlock the keys.

## 2.13 Setting the clock

This section describes the ON and OFF timers that allows you to automatically turn the power ON/OFF.

The ON timer allows you to set the time that will be taken until the power is automatically turned ON. The OFF timer allows you to set the time that will be taken until the power is automatically turned OFF.

Since the timers for the DJ-X2000 use a 24-hour system, the power is automatically turned ON/OFF in accordance with the time settings every day.

### 2.13.1 Setting the OFF timer

#### 1 Call up the TIMER menu.

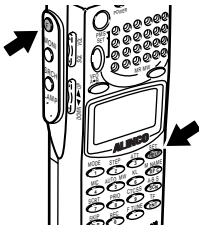

Press the **F** key, and then press the **SET/HELP** key while **F** is shown on the display. The MENU will appear. Point the arrow at **+CONFIG** using the dial or **UP/DOWN** key, and then press the **ENT** key. The CONFIG menu will appear. Point the arrow at **+TIMER**, and then press the **ENT** key. The TIMER menu will appear.

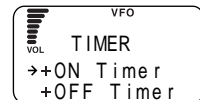

## 2 Call up the OFF timer screen.

Point the arrow at +OFF Timer using the dial or UP/DOWN key, and then press the  key.

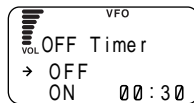



## 3 Set the OFF timer.



Point the arrow at ON using the UP/DOWN key, and then set the time that will be taken until the power is automatically turned OFF (the initial setting is OFF).

The time can be set up to 24 hours in 30-minute steps.

If OFF is selected, the OFF timer is disabled.

After finishing the setting, press the  key. The display will return to the TIMER menu. Point the arrow at END and then press the  key.



(Alternatively, you may press the  key, and then press the  key while  is shown on the display.)

-  *Note:*
- If you exit the TIMER menu by pressing the  key, the setting is canceled.
  - If you set the OFF timer again, the power is turned OFF after the set time has elapsed from the time when the  key is pressed.
  - If the battery is removed or if the hardware reset key is pressed, the setting is canceled.

## 2.13.2 Setting the ON timer

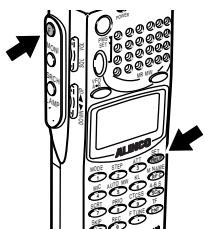
### 1 Call up the TIMER menu.



Press the  key, and then press the  key while  is shown on the display.

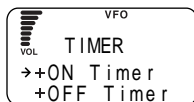

The MENU will appear. Point the

arrow at **+CONFIG** using the dial or **UP/DOWN** key, and then press the  key. The CONFIG menu will appear.

Point the arrow at **+TIMER**, and then press the  key. The TIMER menu will appear.

### 2 Call up the ON Timer screen.

Point the arrow at +ON Timer using the dial or UP/DOWN key, and then press the  key.

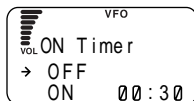

### 3 Set the ON timer.

Point the arrow at ON using the UP/DOWN key, and then use the dial to set the time that will be taken until the power is automatically turned ON (the initial setting is OFF).

The time may be set up to 24 hours in 30-minute steps.

If OFF is selected, the ON timer is disabled.

After finishing the setting, press the **SET HELP** key. The display will return to the TIMER menu. Point the arrow at END and then press the **SET HELP** key. (Alternatively, you may press the **F** key, and then press the **SET HELP** key while **F** is shown on the display.)



- Note:*
- If you exit the TIMER menu by pressing the **SKIP CLR** key, the setting is canceled.
  - If you set the ON timer again, the power is turned ON after the set time has elapsed from the time when the **SET HELP** key is pressed.
  - If the battery is removed or if the hardware reset key is pressed, the setting is canceled.

## 2.14 Basic modes

The DJ-X2000 has three basic modes: VFO, PMS, and MR. The current mode is displayed along the top of the display.

### • VFO mode

This mode is used to select a frequency with the dial or UP/DOWN key and then receive signals at that frequency. The VFO mode was selected at factory.

### • PMS (programmed scan-range) mode

This mode is for tuning in selected channels within a set scan range.

### • MR (memory) mode

This mode is for saving often used frequencies in memory. The frequencies can then be retrieved and tuned in.

### 2.14.1 VFO mode

The VFO mode has two bands: A and B.

#### • To enter the VFO mode

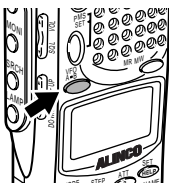

Press the **VFO A=B** key. This will engage the VFO mode. (If the VFO mode is already engaged, pressing the **VFO A=B** key will switch between bands A and B.)

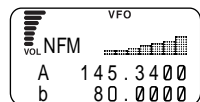

To tune in frequencies or switch bands, see "2.4 Setting frequency" on page 20 and "2.5 Switching frequency band" on page 22.

## 2.14.2 PMS mode

The PMS mode has a total of 20 programmable bands, 10 each for the capital P and lower case p.

### 1 Enter the PMS mode.



Press the  key. This will engage the PMS mode. Then, select a registered band and start scanning. Bands are preregistered before the DJ-X2000 is shipped from the factory, but they can be changed in the expert's mode. (See "3.3.1 Programmed scan operations" on page 64.)

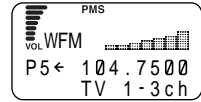

### 2 Select between P and p.

Press the  key to switch back and forth between the capital P and the lower case p.

### 3 Select a memory bank group.

Press the numeric key for the bank you want. The corresponding programmed scanning will start. The scanning direction can be changed using the dial or UP/DOWN key. If you press another numeric key, the corresponding programmed scanning will start.

## 2.14.3 MR mode

The memory mode provides five bank groups from A through E. Each bank group has 10 banks (0-9), each of which allows you to assign a maximum of 40 channels of frequencies (00-39).

### 1 Enter the MR mode.

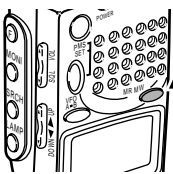

Press the  key. This will engage the MR mode and will display registered frequencies and names.

Frequencies are preregistered before the DJ-X2000 is shipped from the factory, but they can be changed in the expert's mode. (See "3.4.1 Memorizing frequencies" on page 69.)

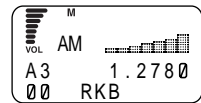

### 2 Select the memory bank group.

Press the  key to switch between memory bank groups A, B and C.

### 3 Select a bank.

Press the numeric keys for the bank No. you want in the selected group.

## 4 Select a channel.

Using the dial or UP/DOWN key, select a channel between 00 and 39. The assigned frequency will appear on the upper line of the display and its name on the lower line.

# 2.15 Using HELP menu

The HELP menu is used to display information on whatever function or operation you want to know. You can go to different setup screens from the HELP items and then set the parameters.

## 1 Display the HELP menu.

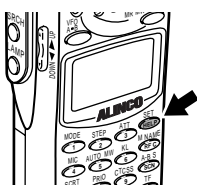

Press the **SET** **HELP** key. The HELP menu will appear.

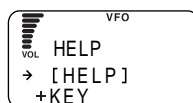

## 2 Select the function on which you want to view an explanation.

Point the arrow at the desired item using the dial or UP/DOWN key, and then press the **TF** **ENT** key. The submenu for that item will appear.

Some items marked with a plus sign (+) have a submenu below them.

Similarly point the arrow at the desired item, and then press the **TF** **ENT** key. Pressing the **SKIP** **CLR** key puts you back to the upper layer.



## 3 Select a HELP item.

Point the arrow at Inst. and then press the **TF** **ENT** key. The selected function will be explained.

Point the arrow at Set! and then press the **TF** **ENT** key. You will go to the setup screen for that function.

If you point the arrow at any item followed by "!" and then press the **TF** **ENT** key, the selected function will be executed.



## 4 Exit the HELP mode.

Hold down the **SKIP** **CLR** key until you go back to the previous screen.



- Note:
- The HELP information can be displayed in English. For further details, see "3.1.7 Selecting a language mode" (page 37).
  - Selecting the Set! item exits the HELP mode. To view the HELP information again, press the **TF** **ENT** key after establishing Set! or canceling it by pressing the **SKIP** **CLR** key.
  - A long explanation shown on the display can be scrolled up and down by pressing the UP/DOWN key.



# 3. Other Useful Functions

This chapter describes the useful functions of the DJ-X2000.

## 3.1 Functions common to all modes

This section describes the functions that are commonly available in the VFO, PMS, and MR modes.

### 3.1.1 Selecting a modulation mode

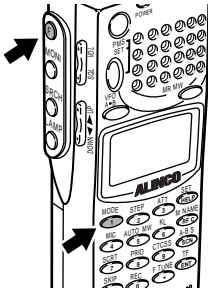

Press the **F** key, and then press the **MODE 1** key while **F** is shown on the display. The MODE menu will appear. Point the arrow at the desired modulation mode using the dial or **UP/DOWN** key, and then press the **IF ENT** key.

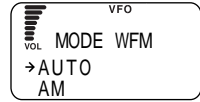

A modulation mode can be selected from AM, NFM, WFM, USB, LSB, CW, and AUTO. If **AUTO** is selected, the most suitable modulation mode will be automatically selected in accordance with the received frequency (the initial mode is **AUTO**).



*Note: In the PMS or MR mode, when DIRECT WR is turned ON (the initial setting is OFF), a signal mode can be selected. For further details, see "3.1.30 Directly changing the settings" (page 60).*

### 3.1.2 Setting the frequency step

Frequency step is the distance that the DJ-X2000 moves from one frequency to the next. It can be selected from 23 fixed settings.

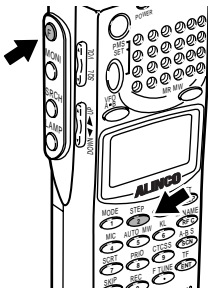

Press the **F** key, and then press the **STEP 2** key while **F** is shown on the display. This will display the STEP menu. Then, move the arrow to the frequency step you want, using the dial or the **UP/DOWN** key, and press the **IF ENT** key.

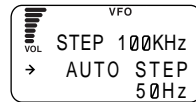

A frequency step can be selected from AUTO STEP, 50 Hz, 100 Hz, 200 Hz, 500 Hz, 1 kHz, 2 kHz, 5 kHz, 6.25 kHz, 8.33 kHz, 9 kHz, 10 kHz, 12.5 kHz, 15 kHz, 20 kHz, 25 kHz, 30 kHz, 50 kHz, 100 kHz, 125 kHz, 150 kHz, 200 kHz, 250 kHz, 500 kHz, and USER STEP.



*Note:* In the PMS or MR mode, setting DIRECT WR to ON enables selection of a frequency step and modulation mode and adjustment of the attenuator and CTCSS decoders. For further details, see "3.1.30 Directly changing the settings" (page 60).

If AUTO STEP is selected, the most suitable frequency step for the received frequency band will be automatically selected.

If USER STEP is selected, a frequency step can be selected freely in a range between 50 Hz and 499.95 kHz.

Example: To enter 150 kHz, press: **REC 0**, **F TUNE \***, **MODE 1**, **AUTO MW 5**, **TF ENT**  
 To enter 450 kHz, press: **REC 0**, **F TUNE \***, **MIC 4**, **AUTO MW 5**, **TF ENT**

Even if a frequency that cannot be divided by the selected step is entered, it is accepted. In this case, however, the beep sound is emitted and "S" appears on the display showing that the DJ-X2000 is operating in non-standard steps.

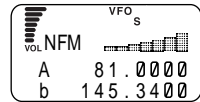

### 3.1.3 Attenuating interference from other channels (ATT)

The attenuator reduces interference from strong signals on other channels so that the signal you want is heard more clearly.

#### 1 Call up the ATT menu.

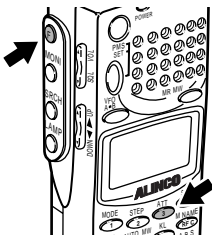

Press the **F** key, and then press the **ATT 3** key while **F** is shown on the display. The ATT menu will appear.

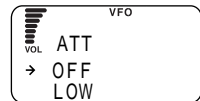

#### 2 Selecting an attenuation level

Point the arrow at the desired attenuation level using the dial or **UP/DOWN** key (the initial setting is **OFF**).

- OFF** Turns the attenuator OFF.
- LOW** Attenuates the affected signals by approx. 10 dB.
- HIGH** Attenuates the affected signals by approx. 20 dB.

**ATT** will appear on the display showing that the attenuation function is turned ON.



- Note:
- The attenuation level slightly varies depending on the frequency.
  - In the PMS or MR mode, setting **DIRECT WR** to **ON** enables selection of a frequency step and modulation mode and adjustment of the attenuator and CTCSS decoders. For further details, see "3.1.30 Directly changing the settings" (page 60).

### 3.1.4 Battery Save

When **ON**, the battery-save feature automatically saves battery power whenever keys are not used or a signal is not picked up for a certain amount of time.

**1**

#### Call up the BATT SAVE screen.

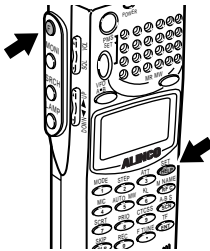

Press the **F** key, and then press the **SET (HELP)** key while **F** is shown on the display.

The **MENU** will appear. Point the arrow at **+CONFIG** using the dial or **UP/DOWN** key, and then press the **TF (ENT)** key.

The **CONFIG** menu will appear. Point the arrow at **+BATT SAVE** and then press the **TF (ENT)** key. The **BATT SAVE** screen will appear.

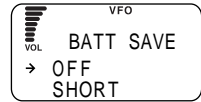

**2**

#### Select an ON/OFF ratio for the battery saving feature.

Point the arrow at the desired **ON/OFF** ratio using the dial or **UP/DOWN** key, and then press the **TF (ENT)** key (the initial setting is **NORMAL**).

The display will return to the **CONFIG** menu. Point the arrow at **END** and then press the **TF (ENT)** key (Alternatively, you may press the **F** key, and then press the **TF (ENT)** key while **F** is shown on the display).



- Note:
- If you exit the **CONFIG** menu by pressing the **SKIP (CLR)** key, the changed setting will be canceled.
  - If **LONG** is selected, the time to keep the internal power source **OFF** becomes longer. This extends the battery life, but delays receiving reaction.

### 3.1.5 Copying data between two receivers (CLONE)

You can copy settings stored in memory from one DJ-X2000 (master) to another (slave). This is referred to as "cloning". Cloning requires a cable with 2.5ø stereo plug to connect the two receivers.

#### 1 Turn ON two DJ-X2000 units and interconnect them.

Detach the cap from the top of each unit. As illustrated below, connect the cable between the CLN terminals.

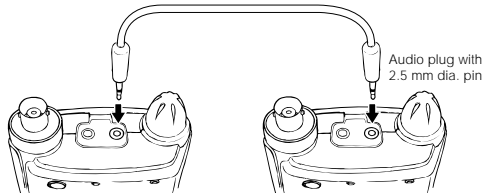

#### 2 Execute the cloning command.

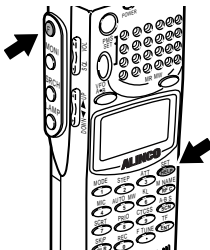

Press the **F** key, and then press the **SET (HELP)** key while **F** is shown on the display. The MENU will appear.

Point the arrow at **+CONFIG** using the dial or **UP/DOWN** key, and then press the **ENT** key. The CONFIG menu will appear. Point the arrow at **+CLONE**, and then press the **ENT** key. The CLONE menu will appear.

Point the arrow at the desired cloning command using the dial or **UP/DOWN** key, and then press the **ENT** key. This operation is not required for the slave unit.

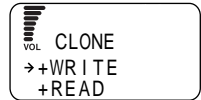

- READ** Copies the data stored in the memory from the other DJ-X2000 unit.
- WRITE** Copies the data stored in the memory to the other DJ-X2000 unit.
- END** Cancels the cloning command without copying any data.

#### • When READ is selected:

Displayed on the master unit

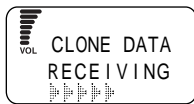

Displayed on the slave unit

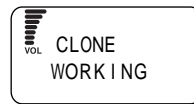

#### • When WRITE is selected:

Displayed on the master unit

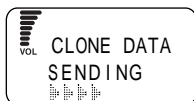

Displayed on the slave unit

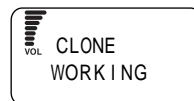

When the cloning procedure is finished, the slave unit returns to the normal screen and the master unit to the CLONE menu.

### 3 Finish the cloning procedure.

Once the cloning procedure is finished, disconnect the cable from both DJ-X2000 units. Press the **SKIP CLR** key on the master unit to exit the CLONE menu. The slave unit can be used without this operation.



**CAUTION:**

- Do not disconnect the cable, nor turn the power OFF during the cloning procedure.
- If a cloning error occurs, press the hardware reset key or remove the battery.

## 3.1.6 Selecting a communication speed

A communication speed during the cloning procedure or communication with a personal computer can be selected (the initial setting is 38400 bps).

#### • To select 38400 bps:



Turn the power ON while holding down the **ATT 3** key.

#### • To select 19200 bps:



Turn the power ON while holding down the **STEP 2** key.

#### • To select 9600 bps:

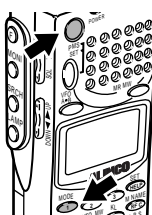

Turn the power ON while holding down the **MODE 1** key.

When the power is turned ON, the communication speed is shown on the display.



- Note:
- The cloning procedure or communication with a personal computer is not possible between DJ-X2000 units with different communication speeds.
  - The initial value is a high speed of 38400 bps. If there are too many communication errors at this speed, retry the communication at a lower speed, e.g., 9600 bps.

### 3.1.7 Selecting a language mode

The DJ-X2000 was set to the English mode at factory, but may be changed to the Japanese mode.

**1**

#### Call up the LANGUAGE screen.

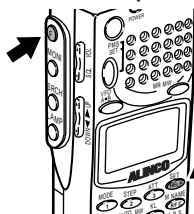

Press the **F** key, and then press the **SET** (HELP) key while **F** is shown on the display.

The MENU will appear. Point the arrow at **+CONFIG** using the dial or **UP/DOWN** key, and then press the **TF** (ENT) key.

The CONFIG menu will appear. Point the arrow at **+LANGUAGE** and then press the **TF** (ENT) key. The LANGUAGE Screen will appear.

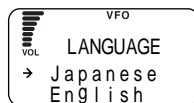

**2**

#### Select a language mode.

Point the arrow at **English** or **Japanese** using the dial or **UP/DOWN** key, and then press the **TF** (ENT) key (the initial setting is English).

The display will return to the CONFIG menu. Point the arrow at END and then press the **TF** (ENT) key (Alternatively, you may press the **F** key, and then press the **TF** (ENT) key while **F** is shown on the display).



- Note: If you exit the CONFIG menu by pressing the **SKIP** (CLR) key, the changed setting is canceled.

### 3.1.8 Field-strength meter

The level of the aperiodic field-strength meter can be set. When the electric field strength reaches the set level, the buzzer sounds. This feature can be used, e.g., to check for transmission from a bug.

The DJ-X2000 provides the following two modes to show electric field strength:

- Meter display mode** Shows changes in electric field strength using the S-meter and beep sound.
- Set level mode** Starts sounding the buzzer when electric field strength reaches the set level.

• Meter display mode

1

Call up the RF CHECK menu.

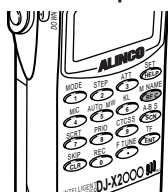

Press the <sup>M NAME</sup>  
(RFC) key. The RF CHECK menu will appear. Point the arrow at **CHECKER** using the dial or **UP/DOWN** key, and then press the <sup>TF</sup>  
(ENT) key.

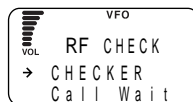

2

Measure the electric field strength.

As the electric field strength increases, the S-meter shows higher levels with faster beeping.

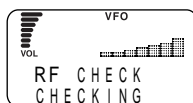

*Note: Since the electric-field meter is intended to measure nearby strong electric field strength, it reacts at a sensitivity of approximately -50 dBm minimum. The sensitivity varies depending on the frequency.*

• Set level mode:

1

Call up the CALL WAIT screen.



Press the <sup>M NAME</sup>  
(RFC) key. The RF CHECK menu will appear. Point the arrow at **CALL WAIT** using the dial or **UP/DOWN** key, and then press the <sup>TF</sup>  
(ENT) key.

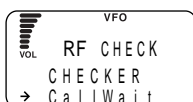



2

Set up the set level mode.

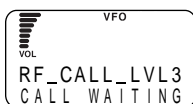
Set the level by selecting a number from 1 through 9 (the initial setting is 3) using the dial, the **UP/DOWN** key, or a numeric key.



When the electric field strength exceeds the set level, the buzzer sounds with  blinking on the display. The buzzer sounds for 10 seconds and  continues to blink.

• Canceling the set level mode

If you press the <sup>SKIP</sup>  
(CLR) key when  is blinking, this blinking stops.

If  is not blinking, pressing the <sup>SKIP</sup>  
(CLR) or <sup>M NAME</sup>  
(RFC) key cancels this mode.



*Note: In the set level mode, only the POWER switch and <sup>LAMP</sup>  
( ) key are valid.*

### 3.1.9 Displaying battery voltage

The battery voltage can be displayed as follows:

#### 1 Call up the BATT VOLT screen.

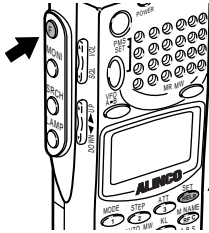

Press the **F** key, and then press the **SET HELP** key while **F** is shown on the display.



The MENU will appear. Point the arrow at **+CONFIG** using the dial or **UP/DOWN** key, and then press the **TF ENT** key. The CONFIG menu will appear. Point the arrow at **+BATT VOLT** using the dial or **UP/DOWN** key, and then press the **TF ENT** key.

The battery voltage will be shown on the display. If you press the **SKIP CLR** key, the display will return to the CONFIG menu.



- Note:
- The measured value is updated every 0.5 second.
  - If an external power source (10-16 V) is used, "OVER 8V" is displayed.

### 3.1.10 Setting the reception tone

The reception tone can be set to either of 2 levels as follows:

#### 1 Call up the TONE screen.

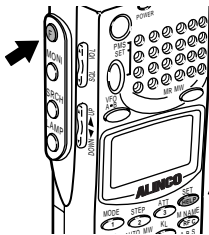

Press the **F** key, and then press the **SET HELP** key while **F** is shown on the display.

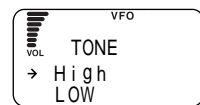

The MENU will appear. Point the arrow at **+CONFIG** using the dial or **UP/DOWN** key, and then press the **TF ENT** key.

The CONFIG menu will appear. Point the arrow at **+TONE** and then press the **TF ENT** key. The TONE screen will appear.

#### 2 Set the reception tone.

Point the arrow at **High** or **Low** using the dial or **UP/DOWN** key, and then press the **TF ENT** key (the initial setting is **High**).

The display will return to the CONFIG menu. Point the arrow at **END** and then press the **TF ENT** key (Alternatively, you may press the **F** key, and then press the **TF ENT** key while **F** is shown on the display).



- Note:
- If you exit the CONFIG menu by pressing the **SKIP CLR** key, the changed setting is canceled.



### 3.1.11 Selecting the BELL mode

In this mode, when the squelch is canceled, a buzzer sounds.

#### 1 Call up the BELL screen.

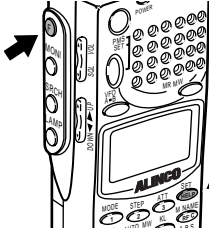

Press the **(F)** key, and then press the **(SET HELP)** key while **F** is shown on the display.

The MENU will appear. Point the arrow at **+CONFIG** using the dial or **UP/DOWN** key, and then press the **(ENT)** key.

The CONFIG menu will appear. Point the arrow at **+BELL** and then press the **(ENT)** key. The BELL screen will appear.

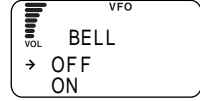

#### 2 Turn the BELL mode ON/OFF.

Point the arrow at **ON** or **OFF** using the dial or **UP/DOWN** key, and then press the **(ENT)** key (the initial setting is **OFF**).

When squelch is canceled, the buzzer sounds for 10 seconds and  starts blinking. Pressing the **(SKIP CLR)** key cancels this blinking.

The display will return to the CONFIG menu. Point the arrow at **END** and then press the **(ENT)** key (Alternatively, you may press the **(F)** key, and then press the **(ENT)** key while **F** is shown on the display).



*Note: If you exit the CONFIG menu by pressing the **(SKIP CLR)** key, the changed setting is cancelled.*

### 3.1.12 Changing the initial message

The initial message that appears after the power has been turned ON can be changed as follows:

#### 1 Call up the MESSAGE screen.

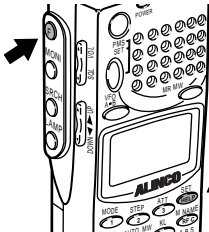

Press the **(F)** key, and then press the **(SET HELP)** key while **F** is shown on the display.

The MENU will appear. Point the arrow at **+CONFIG** using the dial or **UP/DOWN** key and then press the **(ENT)** key.

The CONFIG menu will appear. Point the arrow at **+MESSAGE** and then press the **(ENT)** key. The MESSAGE screen will appear.

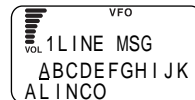





## 2 Enter a message.



Select each character by turning the dial, and then establish it by pressing the **DOWN** key. Pressing the **UP** key allows you to cancel the established character. Up to 36 characters may be entered (the initial setting is **ALINCO INTELLIGENT RECEIVER**).

## 3 Finish the setting.

After you have finished entering the characters, press the  key.

The display will return to the CONFIG menu. Point the arrow at **END** and then press the  key (Alternatively, you may press the  key, and then press the  key while  is shown on the display.



- Note:
- If you exit the CONFIG menu by pressing the  key, the changed setting is canceled.
  - If you turn the dial while holding down the  key, you can move 11 characters ahead.

### 3.1.13 Resetting the receiver

This command resets the DJ-X2000. Be careful as all settings you made up until now may be cleared from memory, depending on your selection.

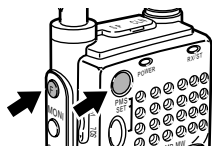

While holding down the  key, turn ON the power. When the DJ-X2000 starts up, the USER RESET menu will appear on the display.



Move the arrow to the reset command you want, using the dial or the **UP/DOWN** key. Then, press the  key. Reset commands are described here following.

- |               |  |
|---------------|--|
| <b>CANCEL</b> | Cancels the reset command entirely.  |
| <b>SYSTEM</b> | Initializes user-set functions, but it does not clear memory channels. (Choose this normally.) |
| <b>ALL</b>    | Clears all functions and memories.   |



**CAUTION:** It takes time to complete the resetting. Do not turn ON the power during the reset.

### 3.1.14 Tuning in frequencies in the PMS/MR modes (M.TUNE)

You can tune in frequencies in the PMS and MR modes. You do not have to return to the VFO mode.

• **To tune in a frequency**



While in the PMS or MR mode, press the **ENT** key. A frequency and **M.TUNE** will appear on the display. Turn the dial or press the **UP/DOWN** keys to tune in a frequency.

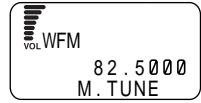

• **To cancel M.TUNE**

Press the **PMS-SET**, **VFO A-B** or **M.R.M.W.** keys.

### 3.1.15 Setting scan resume condition (SCAN MODE)

This setting determines what the DJ-X2000 does when it picks up a signal while scanning. This is referred to as the "scan mode".

**1** Call up the SCAN menu.

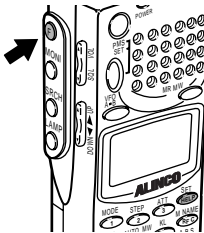

Press the **F** key, and then press the **SET/HELP** key while **F** is shown on the display.

The **MENU** will appear. Point the arrow at **+CONFIG** using the dial or **UP/DOWN** key, and then press the **ENT** key.

The **CONFIG** menu will appear. Point the arrow at **+SCAN** and then press the **ENT** key. The **SCAN** menu will appear.

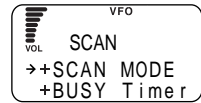

**2** Call up the SCAN MODE screen.

Point the arrow at **+SCAN MODE** using the dial or **UP/DOWN** key, and then press the **ENT** key. The **SCAN MODE** screen will appear.

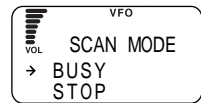

### 3 Select a scanning option.

Point the arrow at the desired option using the dial or **UP/DOWN** key, and then press the **ENT** key. The available scanning options are described below (the initial setting is **BUSY**):

- BUSY** Busy scan. The DJ-X2000 stays on any signal it locates until the signal vanishes. Once the signal disappears, scanning is resumed.
- STOP** The DJ-X2000 stops scanning on the first signal it locates. Scanning is not resumed after the signal vanishes.
- TIMER** When the currently transmitted signals of any frequency are received, scanning is paused for a given period of time. After this specific time period, scanning is resumed even if the signals are being received. For setting the pause period, see "3.1.17 Setting the scanning pause period" (page 44).

The display will return to the SCAN menu. Point the arrow at **END** using the dial or **UP/DOWN** key, and then press the **ENT** key (Alternatively, you may press the **F** key, and then press the **ENT** key while **F** is shown on the display).



*Note:* If you exit the SCAN menu by pressing the **SKIP CLR** menu, the changed setting is canceled.

## 3.1.16 Setting scan signal level

This setting specifies the minimum signal level used in scanning. Scanning will stop only when the DJ-X2000 locates a signal of this strength or stronger.

### 1

Call up the SCAN menu.

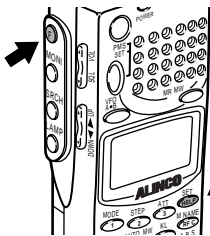

Press the **F** key, and then press the **SET HELP** key while **F** is shown on the display.

The MENU will appear. Point the arrow at **+CONFIG** using the dial or **UP/DOWN** key, and then press the **ENT** key.

The CONFIG menu will appear. Point the arrow at **+SCAN** and then press the **ENT** key. The SCAN menu will appear.

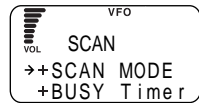

### 2

Call up the S\_LEVEL screen.

Point the arrow to **+S\_LEVEL** using the dial or the **UP/DOWN** key, and then press the **ENT** key.

The S\_LEVEL screen will appear.

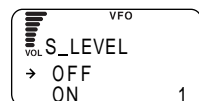

### 3 Select an S-meter level.

Point the arrow at **ON** using the **UP/DOWN** key. Select a level from 1 through 7 using the dial, and then press the  $\text{TF}$  **(ENT)** key. If you do not want to select any S-meter level, select **OFF** and then press the  $\text{TF}$  **(ENT)** key (the initial setting is **OFF**). Higher levels require stronger signals to stop scanning.

The display will return to the SCAN mode. Point the arrow at **END** and then press the  $\text{TF}$  **(ENT)** key (Alternatively, you may press the  $\text{F}$  key, and then press the  $\text{TF}$  **(ENT)** key while **F** is shown on the display).



*Note:* If you exit the SCAN menu by pressing the  $\text{SKIP}$  **(CLR)** key, the changed setting is canceled.

## 3.1.17 Setting the scanning pause period

The scanning pause period for the TIMER option can be set.

### 1

#### Call up the SCAN menu.

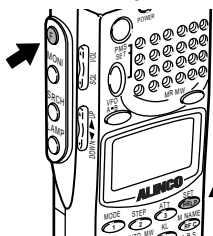

Press the  $\text{F}$  key, and then press the  $\text{SET}$  **(HELP)** key while **F** is shown on the display.

The MENU will appear. Point the arrow at **+CONFIG** using the dial or **UP/DOWN** key, and then press the  $\text{TF}$  **(ENT)** key.

The CONFIG menu will appear. Point the arrow at **+SCAN** and then press the  $\text{TF}$  **(ENT)** key. The SCAN menu will appear.

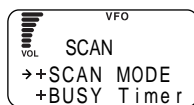

### 2

#### Call up the BUSY TIMER screen.

Point the arrow at **+Busy Timer** and then press the  $\text{TF}$  **(ENT)** key.

The BUSY TIMER screen will appear.

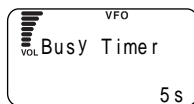

### 3

#### Set the scanning pause period.

Set the scanning pause period using the dial or **UP/DOWN** key, and then press the  $\text{TF}$  **(ENT)** key (the initial setting is 5s).

The display will return to the SCAN menu. Point the arrow at **END** and then press the  $\text{TF}$  **(ENT)** key (Alternatively, you may press the  $\text{F}$  key, and then press the  $\text{TF}$  **(ENT)** key while **F** is shown on the display).



*Note:* If you exit the SCAN menu by pressing the  $\text{SKIP}$  **(CLR)** key, the changed setting is canceled.

### 3.1.18 Turning the priority function ON/OFF

The priority function checks another channel (priority channel) every 5 seconds while monitoring the current frequency. For the settings of the priority feature, see "3.1.19 Selecting a priority option" (page 45), "3.1.20 Selecting a priority channel" (page 46), and "3.1.21 Specifying a priority interval" (page 47).

• **To turn the priority function ON**

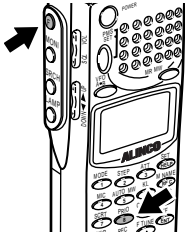

Press the **F** key, and then press the **PRIORITY** key while **F** is shown on the display. **PRIO** will appear at the top of the display. This means the priority function is ON.

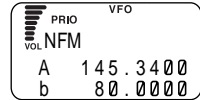

• **Turn the priority feature OFF.**

Press the **F** key, and then press the **PRIORITY** key with **F** shown on the display. "PRI" shown at the top of the screen will disappear showing that the priority feature is turned OFF.



*Note: If the priority feature is ON, the CH SCOPE mode is disabled.*

### 3.1.19 Selecting a priority option

Select an operation option of the DJ-X2000, which is applicable if signals are received on the priority channel when the priority feature is active.

**1** **Call up the PRIO menu.**

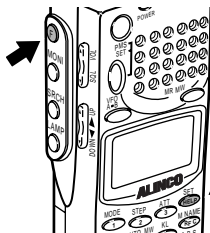

Press the **F** key, and then press the **SET/HELP** key while **F** is shown on the display.

The MENU will appear. Point the arrow at **+PRIO** using the dial or **UP/DOWN** key, and then press the **ENT** key. The PRIO menu will appear.

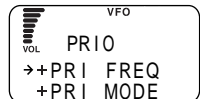

## 2 Call up the PRI MODE screen.

Point the arrow at **+PRI MODE** using the dial or **UP/DOWN** key, and then press the **ENT** key. The PRI MODE screen will appear.



## 3 Select a priority option.

Select a priority option using the dial or **UP/DOWN** key, and then press the **ENT** key. The available options are listed below (the initial setting is **STOP**).

- BUSY** When signal is received on the priority channel, the DJ-X2000 stays on the priority frequency until the signal vanishes.
- STOP** When signal is received on the priority channel, the DJ-X2000 stays on the priority frequency even after the signal vanishes.
- TIMER** Once signals are received on the priority channel, they will be received for a given interval. For specifying this interval, see "3.1.21 Specifying a priority interval" (page 47).

The display will return to the PRIO menu. Point the arrow at **END** using the dial or **UP/DOWN** key, and then press the **ENT** key (Alternatively, you may press the **F** key, and then press the **ENT** key while **SKIP CLR** is shown on the display).

 *Note: If you exit the PRIO menu by pressing the **SKIP CLR** key, the changed setting is canceled.*

## 3.1.20 Setting a priority channel

This setting allots a memory channel for the priority scan. The priority scan must be ON for this setting to be effective.

### 1 Call up the PRIO menu.

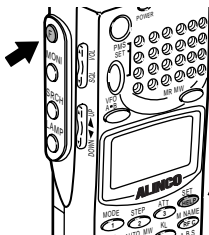

Press the **F** key, and then press the **SET HELP** key while **F** is shown on the display.

The MENU will appear. Point the arrow at **+PRIO** using the dial or **UP/DOWN** key, and then press the **ENT** key. The PRIO menu will appear.

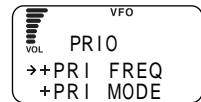

### 2 Call up the PRIO FREQ menu.

Point the arrow at **+PRIO FREQ** and then press the **ENT** key. The PRIO FREQ menu will appear.

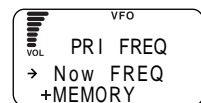





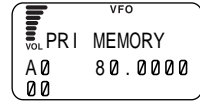

### 3 Call up the PRI MEMORY screen.

Point the arrow at **+MEMORY** using the dial or **UP/DOWN** key, and then press the  key. The PRI MEMORY screen will appear.





### 4 Select a channel.

Select the desired memory bank and channel, and then press the  key. The memory bank can be selected from A through E using the  key. The bank number can be selected using the dial or a numeric key. Pressing the **UP/DOWN** key moves the arrow, allowing you to select the channel number with the dial or a numeric key.

The display will return to the PRI FREQ menu. Point the arrow at **END** and then press the  key (Alternatively, you may press the  key, and then press the  key while  is shown on the display).







- Note:
- To select the currently received frequency for the priority channel, point the arrow at **Now FREQ** in step 2 and then press the  key (the initial setting is **Now FREQ**).
  - If you point the arrow at **Now Pri** and press the  key, the frequency currently selected for the priority channel is displayed.
  - If you exit the PRI FREQ menu the changed setting is canceled.

## 3.1.21 Specifying a priority interval

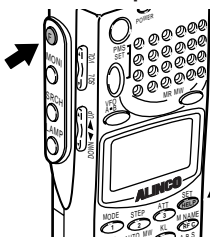
Specify an interval for activating the priority feature.

### 1 Call up the PRIO menu.



Press the  key, and then press the  key while  is shown on the display.

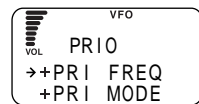

The MENU will appear. Point the arrow at **+PRIO** using the dial or **UP/DOWN** key, and then press the  key. The PRIO menu will appear.

### 2 Call up the PRI Timer screen.

Point the arrow at **+PRI Timer** and then press the  key. The PRI Timer screen will appear.

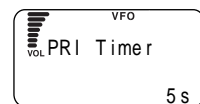



### 3 Specify a priority interval.

Specify a priority interval in a range between 1 and 20 seconds in 1-second steps using the **UP/DOWN** key, and then press the **ENT** key (the initial setting is 5s).

The display will return to the PRIO menu. Point the arrow at **END** and then press the **ENT** key (Alternatively, you may press the **F** key, and then press the **ENT** key while **F** is shown on the display).

 *Note: If you exit the PRIO menu by pressing the **SKIP CLR** key, the changed setting is canceled.*

## 3.1.22 Setting search resume condition (SRCH MODE)

For the DJ-X2000 to perform the Channel Scope function, its receiver is used for searching for signals, and the sound will be intermittent at the moment when the search takes place.

This setting determines how often the search takes place in the Channel Scope function. This is referred to as the “search mode”.

### 1 Call up the CH SCOPE menu.

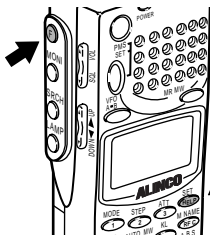

Press the **F** key, and then press the **SET (HELP)** key while **F** is shown on the display.

The MEMU will appear. Point the arrow at **+CONFIG** using the dial or **UP/DOWN** key, and then press the **ENT** key.

The CONFIG menu will appear. Point the arrow at **+CH SCOPE** and then press the **ENT** key. The CH SCOPE menu will appear.

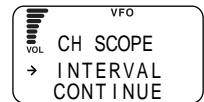

## 2 Select a search resuming option.

Point the arrow at the desired option using the dial or **UP/DOWN** key, and then press the **ENT** key. The available options are described below (the initial setting is **INTERVAL**):

- SINGLE** The search is carried out only once when the **SRCH** key is pressed. It is not carried out a second time until the first search is canceled and the **SRCH** key is pressed again.
- INTERVAL** A search is carried out once every about 10 seconds updating the spectrum condition. Sound is muted the moment the search takes place.
- CONTINUE** Searching is continuous and the spectrum condition is renewed continuously. In this case, no sound is heard from the DJ-X2000.

The display will return to the CH SCOPE menu. Point the arrow at **END** and then press the **ENT** key (Alternatively, you may press the **F** key, and then press the **ENT** key while **F** is shown on the display).



*Note:* If you exit the CH SCOPE menu by pressing the **SKIP CLR** key, the changed setting is canceled.

## 3.1.23 Flash tune

The DJ-X2000 automatically tunes in to the detected radio frequency, allowing you to instantaneously tune in to and receive unknown radio frequencies.

### • Selecting the Flash tune.

The Flash tune is available in two modes, FLASH TUNE and F COUNTER.

1

### Call up the FLASH TUNE screen.

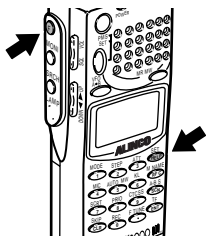

Press the **F** key, and then press the **SET HELP** key while **F** is shown on the display.

The MEMU will appear. Point the arrow at **+SPECIAL** using the dial or **UP/DOWN** key, and then press the **ENT** key.

The SPECIAL screen will appear. Point the arrow at **+FLASH TUNE** and then press the **ENT** key.

The FLASH TUNE screen will appear.

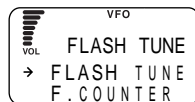

## 2 Select the Flash tune.

Point the arrow at the desired option using the dial or **UP/DOWN** key, and then press the **ENT** key (the initial setting is **FLASH TUNE**).

**FLASH TUNE** Instantaneously checks for a radio frequency and automatically tunes in to the detected frequency.

**F. COUNTER** Checks for a radio frequency and shows the detected frequency in real time (the frequency resolution is 100 Hz).

The display will go back to the CONFIG menu. Point the arrow at END, and then press the **ENT** key (or alternatively, press the **F** key, and then press the **ENT** key while **F** is shown on the display).

 *Note:* • If you exit the CH SCOPE menu by pressing the **SKIP CLR** key, the changed setting is canceled.

### • Starting the Flash tune

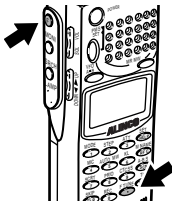

Press the **F** key, and then press the **F TUNE** key while **F** is shown on the display. The Flash tune will start.

Pressing the **SKIP CLR** key cancels the Flash tune.

 *Note:* • The operating frequencies in the FLASH TUNE and F. COUNTR modes ranges from approximately 50 MHz to 1300 MHz. The Flash tune starts with input of approximately -30 dB or more. However, if there is any strong radio or noise than the targeted radio, the Flash tune may not be activated depending on the frequency condition.

- This function is not applicable to intermittent radio in intervals of 0.1 second or less, such as digital radio.
- The Flash tune is not valid for radio that fluctuates by 1 kHz or more.
- If the Flash tune is set during scanning in the PMS or MR mode, the scanning is canceled.

## 3.1.24 Descrambler

This function descrambles the scrambled voice signals.



**Note:**

- Only the NFM type radio signals can be descrambled.
- The descrambler function on this page is not available in the DJ-X2000 which is sold in the United States. The unauthorized use of this feature in the U.S. may result in penalties (Privacy Protection Act 1986). For the other versions, it is recommended that you check local regulations before using this feature.

**1**

**Call up the SET SCRAMBLE screen and then turn ON the Descrambler.**

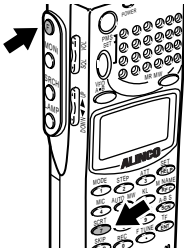

Press the  $\text{F}$  key, and then press the  $\text{SCRT}$  (7) key while  $\text{F}$  is shown on the display.

The SET SCRAMBLE screen will appear. Point the arrow at **ON** using the **UP/DOWN** key.

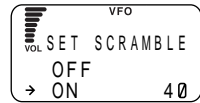

**2**

**Control the carrier.**

With the arrow pointing at **ON**, set the carrier to the state where the voice can be recognized. The carrier can be increased or decreased in a range between 0 and 125 (the initial setting is **40**).

If you press the  $\text{TF}$  ( $\text{ENT}$ ) key with the arrow pointing at **ON**, the normal screen appears with the Descrambler being active.

### • Canceling the Descrambler

Press the  $\text{SKIP}$  ( $\text{CLR}$ ) key. This will cancel the Descrambler.

### • Priority in comparison with the CTCSS decoding function and A/B squelch

The Descrambler cannot be used with the CTCSS decoding function or A/B squelch.

- If the A/B squelch is turned ON when the Descrambler is active, the A/B squelch takes priority.
- The CTCSS decoding function cannot be used when the Descrambler or A/B squelch is active.
- If the Descrambler is turned ON when the CTCSS decoding function is active, the CTCSS decoding function remains disabled until the Descrambler is turned OFF.



**Note:**

- If you press the  $\text{TF}$  ( $\text{ENT}$ ) key to display the normal screen when the Descrambler is active, the Descrambler is disabled for any modulation mode other than the NFM.
- If "VOL" is blinking on the display when the Descrambler is active, the sound volume can be controlled.

## 3.1.25 CTCSS decoding function

This function is used to receive CTCSS tones. It allows you to receive 38 CTCSS tones and even select reverse reception. The function is also applicable to taxi radio.



*Note:* Only the NFM modulation can receive CTCSS tones.

### • Setting the reception of CTCSS tones

Specify the reception frequency of CTCSS tones and turn ON/OFF their reception.

**1**

#### Call up the CTCSS MANUAL screen.

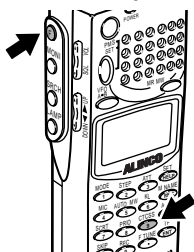

Press the **(F)** key, and then press the **(9)** key while **(F)** is shown on the display.

The CTCSS SET menu will appear.

Point the arrow at **+MANUAL** using the dial or **UP/DOWN** key, and then press the **(TF)** key.

The CTCSS MANUAL screen will appear.

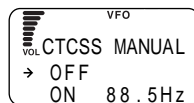

**2**

#### Select the reception frequency of the CTCSS signal.

Point the arrow at **ON** using the **UP/DOWN** key, and then select the reception frequency of CTCSS tones using the dial.

The range of selectable frequencies is between 67.0 Hz and 254.1 Hz (the initial setting is **88.5 Hz**).

If you do not want to receive CTCSS tones, select **OFF**.

Press the **(TF)** key to complete the setting.

### • Priority order in comparison with the Descrambler and A/B squelch

The CTCSS decoding function cannot be used with the Descrambler or A/B squelch.

- If the Descrambler or A/B squelch is active, the CTCSS decoding function is disabled.
- If the Descrambler or A/B squelch is turned ON when the CTCSS decoding function is active, the CTCSS decoding function is disabled during its use.



*Note:* In the PMS or MR mode, when DIRECT WR is turned ON, this setting is possible (the initial setting is ON). For further details, see "3.1.30 Directly changing the settings" (page 60).

### • CTCSS scanning

This function is used to scan for CTCSS tones.

#### 1 Call up the CTCSS SET menu.

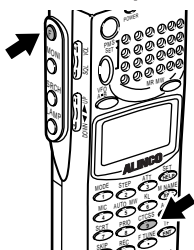

Press the **F** key, and then press the **CTCSS 9** key while **F** is shown on the display. The CTCSS SET menu will appear.

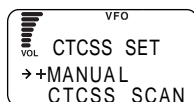

#### 2 Start scanning

Point the arrow at **CTCSS SCAN** using the dial or **UP/DOWN** key, and then press the **IF ENT** key. This will start scanning. Once CTCSS tones are detected, the scanning stops.

### • CTCSS reversing

This function used to reverse the CTCSS decoding function. When it is set to ON, the DJ-X2000 receives those signals that do not match the CTCSS tones. When the DJ-X2000 receives those signals that match the CTCSS tones, their sounds are muted.

#### 1 Call up the CTCSS REVERSE screen.

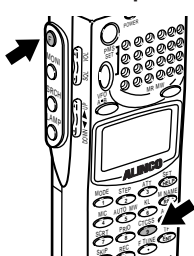

Press the **F** key, and then press the **CTCSS 9** key while **F** is shown on the display.

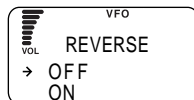

The CTCSS SET menu will appear. Point the arrow at **+REVERSE** using the dial or **UP/DOWN** key, and then press the **IF ENT** key. The CTCSS REVERSE screen will appear.

#### 2 Select ON/OFF for the CTCSS reversing function.

Point the arrow at **ON** or **OFF** using the dial or **UP/DOWN** key, and then press the **IF ENT** key.



*Note: This function may fail if signals are too weak or include too many noises.*

### 3.1.26 A/B squelch

This function is used to start squelch by detecting Continuous Carrier Repeater System (CCRS) carrier signal.

**1 Call up the A/B SQ SET screen.**

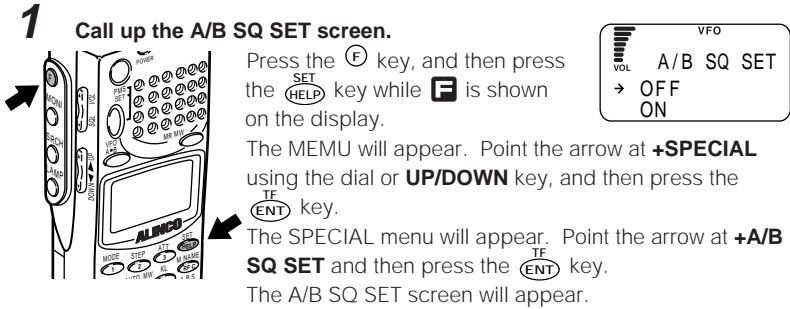

Press the **F** key, and then press the **SET (HELP)** key while **F** is shown on the display.

The MEMU will appear. Point the arrow at **+SPECIAL** using the dial or **UP/DOWN** key, and then press the **TF (ENT)** key.

The SPECIAL menu will appear. Point the arrow at **+A/B SQ SET** and then press the **TF (ENT)** key.

The A/B SQ SET screen will appear.

**2 Select ON/OFF for A/B squelch.**

Point the arrow at **ON** or **OFF** using the dial or **UP/DOWN** key, and then press the **TF (ENT)** key (the initial setting is **OFF**).

- ON** If modulation signals of 2300 Hz used for Continuous Carrier Repeater System (CCRS) are detected, the squelch is activated and the sound is muted. If those signals are no longer detected, the squelch is canceled.
- OFF** The A/B squelch is disabled.

**• Priority order in comparison with the Descrambler and CTCSS decoding function**

The A/B squelch cannot be used with the Descrambler or CTCSS decoding function.

- If the A/B squelch is turned ON when the Descrambler is active, the A/B squelch takes priority.
- If the Descrambler or A/B squelch is active, the CTCSS decoding function is disabled.
- If the A/B squelch is turned ON when the CTCSS decoding function is active, the CTCSS decoding function is canceled during its use.



- Note:*
- This function may fail if radio or modulation signals are too weak or include too many noises.
  - It is not applicable to Continuous Carrier Repeater System (CCRS) carrier signal of any frequency other than 2300 Hz.

## 3.1.27 Transweeper™

This function is used to detect a wireless microphone or any other bug using radio and locate the place where it is installed. If you previously assign any frequency expected for bugging purposes to the memory channel or auto memory channel, the DJ-X2000 will scan for that frequency. The settings for bank link and channel skipping will become valid.

### 1 Turn ON the transweeper.

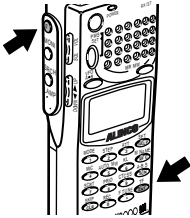

Press the **F** key, and then press the **ENT** key while **F** is shown on the display.

The transweeper will start.

The scanning varies depending on the basic mode in use.



#### VFO mode

The scanning is performed from the currently received frequency toward higher frequencies. The scanning direction is changed using the dial or **UP/DOWN** key.

#### MR mode

Only the specified bank is scanned. The settings for bank link and channel skipping become valid. Pressing the **SCN** key starts the scanning.

#### PMS mode

The scanning is performed only within the programmed scanning range that you have specified.

### 2 Check for bugging.

In this state, control the sound volume and the orientation of the DJ-X2000. If the existence of any bug is detected, the display changes as shown here.

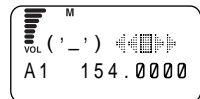

### 3 Search for the location of the bug while slowly bringing the DJ-X2000 closer to that bug.

You can find the distance to the location of the bug according to the changes on the display.

- As the DJ-X2000 comes closer to the bug.

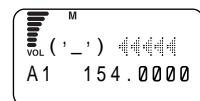



- As the DJ-X2000 goes away from the bug.

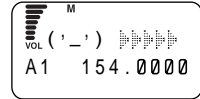

- The number of ■ shown at the lower right corner of the display tells you the distance to the location of the bug. Each ■ represents approximately 1 m. For example, 5 ■ show that the bug is located more than 5 m away.

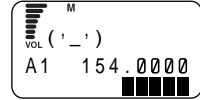

*Note: If no bug is found after the specified range has been scanned, the message "NO FOUND" appears on the display.*



- CAUTION:**
- The effective range of sound monitoring for bugs is normally between approximately 1 m and 5 m.
  - The transweeper is greatly affected by the intensity of radio from the bug and the sensitivity of the microphone. It may malfunction or fail depending on the ambient conditions (where there are too many echoes).
  - If the DJ-X2000 is suddenly moved during its transweeper process, the Doppler effect causes a malfunction.
  - The transweeper may not work normally depending on the relation between the orientation of the speaker and the location of the bug.
  - This function does not work normally when radio with modulation signals of 2300 Hz is received.

## 3.1.28 Recording function

This function is used to record the received sound or sound from the speaker using the internal IC. It allows you to record such sound for 160 seconds maximum. Recording, playback, and erasing can be repeatedly recorded approximately 10,000 times.

### • Selecting a source

Specify which sound is recorded, the received sound or the sound from the microphone.

#### 1 Call up the REC screen.

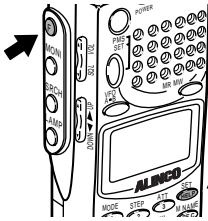

Press the **F** key, and then press the **SET** (**HELP**) key while **F** is shown on the display.

The MENU will appear. Point the arrow at **+SPECIAL** using the dial or **UP/DOWN** key, and then press the **ENT** key.

The SPECIAL screen will appear. Point the arrow at **+REC** and then press the **ENT** key. The REC screen will appear.

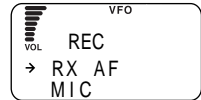

#### 2 Select the received sound or the sound from the microphone.

Point the arrow at the desired option using the dial or **UP/DOWN** key, and then press the **ENT** key (the initial setting is **MIC**).

- RX AF** The received sound is recorded.
- MIC** The sound from the microphone is recorded.

The display will return to the SPECIAL screen. Point the arrow at **END** and then press the **F** key (Alternatively, you may press the **F** key, and then press the **ENT** key while **F** is shown on the display).

### • Recording the sound

#### 1 Call up the recording screen.

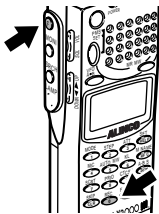

Press the **F** key, and then press the **REC** (**0**) key while **F** is shown on the display.

The recording screen will appear.

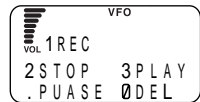

#### 2 Start the recording

Press the **MODE** (**1**) key. The recording will start and the elapsed time will appear on the display. The sound can be recorded for 160 seconds maximum.

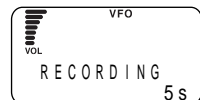

### 3 Stop or pause the recording.

To stop the recording, press the **STEP 2** key.

To pause (temporarily stop) the recording, press the **F TUNE** key. If you press the **F TUNE** key again, the recording is resumed.

When the recording time reaches 160 seconds, "END" appears on the display and the recording stops automatically.

### 4 Exit the recording mode.

Press the **SKIP CLR** key.



- Note:*
- Only a single session of sound can be recorded.
  - No other function can be used during the recording.
  - The sound volume can be controlled in the recording mode.
  - Sound can be repeatedly recorded approximately 10,000 times.
  - The RX AF recording starts when sound signal is received.

#### • Playing back the recorded sound

### 1 Call up the recording screen.

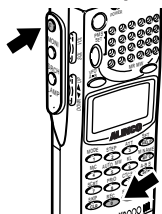

Press the **F** key, and then press the **REC 0** key while **F** is shown on the display.

The recording screen will appear.

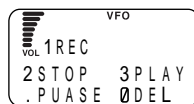

### 2 Start the playback.

Press the **ATT 3** key. The playback will start and the elapsed time will appear on the display.

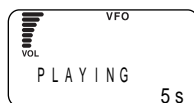

### 3 Stop or pause the playback.

To stop the playback, press the **STEP 2** key.

To pause (temporarily stop) the playback, press the **F TUNE** key.

If you press the **F TUNE** key again, the playback is resumed.

After all the recorded sound has been played back, "END" appears on the display and the playback stops automatically.

### 4 Exit the recording mode.

Press the **SKIP CLR** key.



- Note:*
- No other function can be used during playback.
  - No battery backup is required to store the recorded data.
  - If the all reset function is used, the recorded data is erased.

• Erasing the recorded data

**1** Call up the recording screen.

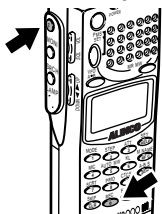

Press the **F** key, and then press the **REC** key while **F** is shown on the display. The recording screen will appear.

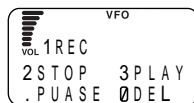

**2** Erase the recorded data.

Press the **REC** key. The recorded data will be erased.

**3** Exit the recording mode.

Press the **SKIP CLR** key.

## 3.1.29 Sound pickup

The sound picked up through the microphone can be amplified and heard using an earphone or external speaker.

• Picking up sound

**1** Connect an earphone or external speaker to the SP terminal on the top of the DJ-X2000.

**2** Start picking up sound.

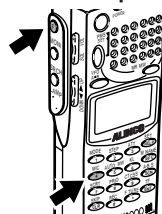

Press the **F** key, and then press the **MIC** key while **F** is shown on the display. The sound pickup will start.

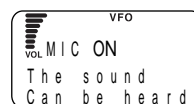

• Canceling the sound pickup

Press the **SKIP CLR** key.



- Note:
- If no earphone or external speaker is connected, the sound pickup does not function. If you try to use this function without connecting any earphone or external speaker, the beep sound is emitted and the message "INSERT EARPHONE" appears on the display.
  - Only the POWER switch, VOL key, and **SKIP CLR** key are valid during the sound pickup.
  - If howling occurs, turn down the volume or keep the earphone or external speaker away from the microphone.

### 3.1.30 Directly changing the settings

This function allows you to enable/disable the direct changes of the settings for modulation mode, frequency step, attenuator, and CTCSS decoding function in the MR or PMS modes. When it is turned ON, the settings for modulation mode, frequency step, attenuator, and CTCSS decoding function can be directly changed in the currently displayed MR or PMS mode.

#### 1 Call up the DIRECT WR screen.

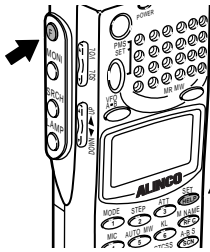

Press the  $\text{F}$  key, and then press the  $\text{SET HELP}$  key while  $\text{F}$  is shown on the display.

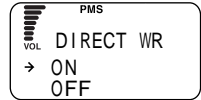

The MENU will appear. Point the arrow at **+CONFIG** using the dial or **UP/DOWN** key, and then press the  $\text{ENT}$  key.

The CONFIG screen will appear. Point the arrow at **+DIRECT WR** and then press the  $\text{ENT}$  key. The DIRECT WR screen will appear.

#### 2 Selecting ON/OFF for DIRECT WR.

Point the arrow at **ON** or **OFF** using the dial or **UP/DOWN** key, and then press the  $\text{ENT}$  key (the initial setting is **OFF**).

The display will return to the CONFIG screen. Point the arrow at **END** and then press the  $\text{ENT}$  key (Alternatively, you may press the  $\text{F}$  key, and then press the  $\text{ENT}$  key while  $\text{F}$  is shown on the display).



*Note:* If you exit the CONFIG screen by pressing the  $\text{SKIP CLR}$  key, the changed settings are canceled.

## 3.2 Functions in the VFO mode

This section describes various functions available in the VFO mode.

### 3.2.1 VFO link function

This function is used to synchronously change two VFO frequencies, the currently received frequency and another frequency.

#### 1 Call up the LINK SET screen.



Specify frequencies in bands A and B of VFO.  
Press the **F** key, and then press the **SKIP CLR** key while **F** is shown on the display.  
The LINK SET screen will appear.



#### 2 Select a type of the VFO link function.

Point the arrow at the desired option using the dial or **UP/DOWN** key, and then press the **ENT** key (the initial setting is **LINK OFF**).

- |                  |   |
|------------------|---|
| <b>AUTO LINK</b> | The frequencies in bands A and B interlock and change at the interval that was set using the auto link function.  |
| <b>USER LINK</b> | Both bands A and B are displayed in capital letters and the VFO link function becomes active. As the frequency on the upper line of the display is changed, the one on the lower line changes simultaneously. |
| <b>LINK OFF</b>  | The VFO link function is canceled.  |



*Note: The frequency on the upper line may exceed 2149.999950 MHz (the upper limit for the DJ-X2000) when it is changed. In this case, press the **VFO A-B** key toggle between bands A and B. The band shown on the upper line will be switched to the lower line. The band shown on the lower line (exceeding 2149.9999 MHz) will be included in a range between 0.1 MHz and 2149.999 MHz and then switched to the upper line while maintaining the difference between the two frequencies. The VFO link function is not canceled.*

## 3.2.2 Scanning between VFO's A and B (AB SCAN)

This function is for scanning the band between the current frequencies of VFO-A and VFO-B.

### • To scan between VFO's A and B

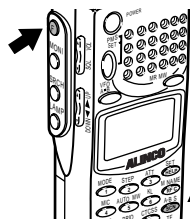

Set frequency on each band A and B.

Press the **F** key, and then press the **A-B S (SCN)** key while **F** is shown on the display.

This will start scanning and will display the arrow next to both bands.

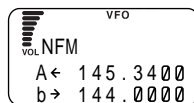

Scanning direction can be changed using the dial or the **UP/DOWN** key.

### • To cancel AB scan

Press the **A-B S (SCN)** key. This will cancel AB scanning.

## 3.2.3 Copying frequencies from memories to the VFO

You can copy frequencies from a memory channel to the VFO.

### 1 Call up the frequency in memory.

Press the **M/R/MW** key to get the MR mode. Then set the memory bank No. and channel No. you want .

### 2 Copy the frequency into the VFO.

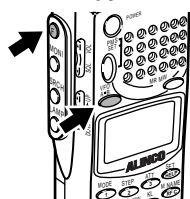

Press the **F** key, and then press the **VFO A-B** key while **F** is shown on the display.

The frequency in the selected memory channel will be displayed on the upper line (currently used) band.

### 3.2.4 Copying frequencies from the PMS mode to the VFO



You can copy frequencies in the PMS mode to the VFO.

#### 1 Call up the frequency in memory.

Press the  key to get the PMS mode. Then set the program bank No. you want to display in the VFO mode.

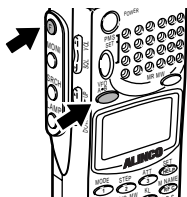
#### 2 Copy the frequency into the VFO.



Press the  key, and then press the  key while  is shown on the display.

The frequency in the selected program bank will be displayed on the upper line (currently used) band the instant that scanning picks it up.



## 3.3 PMS mode functions

This section explains operations in the PMS mode.

### 3.3.1 Programmed scan operations

This section is for programmed scan operations.

Starting the scanning frequency apply for low frequency, and ending the scanning frequency apply for high frequency in the VFO.

A modulation mode and a frequency step apply for the active VFO (indicated in uppercase A or B) settings.

#### 1 Call up the PMS SET screen.

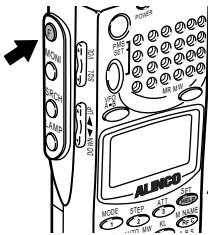

Press the **(F)** key, and then press the **(SET/HELP)** key while **F** is shown on the display.

The MENU will appear. Point the arrow at **+PMS** using the dial or **UP/DOWN** key, and then press the **(TF/ENT)** key.

The PMS screen will appear. Point the arrow at **+PMS SET** and then press the **(TF/ENT)** key. The PMS SET screen will appear.

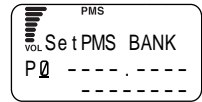

#### 2 Select the bank on which you want to store the scanning program.

Using the dial or numeric keys, select the bank on which you want to store the scanning program. Press the **(TF/ENT)** key (Pressing the **(F TUNE)** key toggles between the uppercase P and the lowercase p).

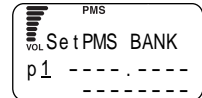

#### 3 Specify the frequency to start the scanning.

Using numeric keys, enter the frequency at which you want to start the scanning. Press the **(TF/ENT)** key.

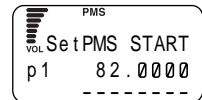

#### 4 Specify the frequency to end the scanning.

Using numeric keys, enter the frequency at which you want to end the scanning. Press the **(TF/ENT)** key.

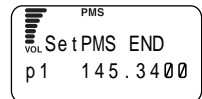

## 5 Give a name to the program.

Select each character by turning the dial and then establish it by pressing the **DOWN** key. The established character can be canceled by pressing the **UP** key. Up to 8 characters may be entered for the name.

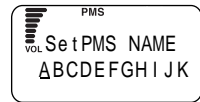

## 6 Store the scanning program.

After you have finished entering the name, press the **ENT** key. The display will return to the PMS menu. Point the arrow at **END** and then press the **ENT** key (Alternatively, you may press the **F** key, and then press the **ENT** key while **F** is shown on the display).



*Note: In naming the program, you can move 11 characters ahead by turning the dial while holding down the **F** key.*

## 3.3.2 Setting scan pass-frequency

This setting specifies frequencies to be passed in the scanning operation regardless of signal presence. As many as 50 pass frequencies can be set in a single program bank.

### • To set pass frequencies

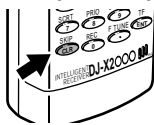

Press the **PMS-SET** key to get the PMS mode. Then set the program bank where pass frequencies are to be set. Press the **SKIP CLR** key whenever the program stops on a frequency you want to pass.

### • To clear pass settings

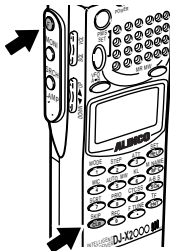

Press the **F** key, and then press the **SKIP CLR** key while **F** is shown on the display. This will display the PASS EDIT display. Then move the arrow to pass frequency settings you want to clear, using the dial or the **UP/DOWN** keys, and press the **REC 0** key. The selected frequency will disappear from the display. Press the **ENT** key to exit.

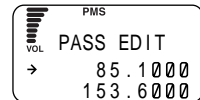

### 3.3.3 Setting program link

This function lets you scan a combination of frequency ranges.

#### 1 Call up the PMS Bank Link screen.

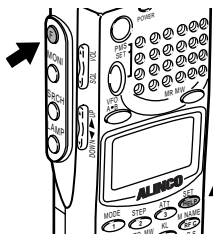

Press the **P** key, and then press the **SET** key while **F** is shown on the display.

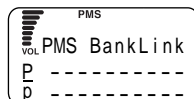

The MENU will appear. Point the arrow at **+PMS** using the dial or **UP/DOWN** key, and then press the **ENT** key.

The PMS menu will appear. Point the arrow at **+PMS LINK** and then press the **ENT** key. The PMS Bank Link screen will appear.

#### 2 Enter a program bank number.

Using a numeric key, enter the program number you want to link. Pressing the **F** key toggles between the uppercase **P** and the lowercase **p**. To link all the programs, enter all the numbers from 0 to 9.

After you have finished entering the number(s), press the **ENT** key.

The display will return to the PMS menu. Point the arrow at **END** and then press the **ENT** key (Alternatively, you may press the **F** key, and then press the **ENT** key while **F** is shown on the display).

### 3.3.4 Copying scan programs

This function copies scan programs from one bank to another.

#### 1 Call up the PMS EDIT screen.

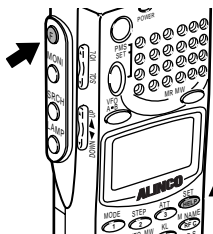

Press the **P** key, and then press the **SET** key while **F** is shown on the display.

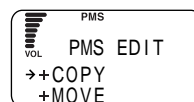

The MENU will appear. Point the arrow at **+PMS** using the dial or **UP/DOWN** key, and then press the **ENT** key.

The PMS menu will appear. Point the arrow at **+PMS EDIT** and then press the **ENT** key.

#### 2 Call up the COPY screen.

Point the arrow at **+COPY** using the dial or **UP/DOWN** key, and then press the **ENT** key.

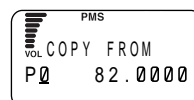

### 3 Select a source program.

Using the dial or a numeric key, select the program you want to copy. Press the **ENT** key (pressing the **TUNE** key toggles between the uppercase **P** and lowercase **p**).

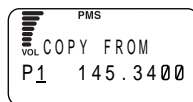

### 4 Select a destination program.

Using the dial or a numeric key, select the program to which you want to copy the source program. Press the **ENT** key (pressing the **TUNE** key toggles between the uppercase **P** and the lowercase **p**).

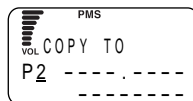

To retry the setting, press the **SKIP CLR** key.

The display will return to the PMS EDIT menu. Point the **END** and then press the **ENT** key (Alternatively, press the **F** key, and then press the **ENT** key while **F** is shown on the display).

## 3.3.5 Moving a scanning program

The selected scanning program may be moved to another program number.

### 1 Call up the PMS EDIT menu.

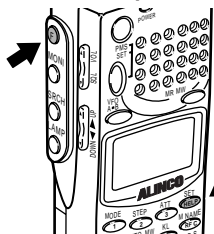

Press the **F** key, and then press the **SET (HELP)** key while **F** is shown on the display.

The MENU will appear. Point the arrow at **+PMS** using the dial or **UP/DOWN** key, and then press the **ENT** key.

The PMS menu will appear. Point the arrow at **+PMS EDIT** and then press the **ENT** key. The PMS EDIT menu will appear.

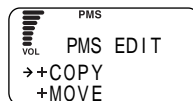

### 2 Call up the MOVE screen.

Point the arrow at **+MOVE** using the dial or **UP/DOWN** key, and then press the **ENT** key.

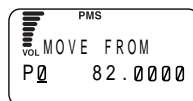

### 3 Select the program you want to move.

Using the dial or a numeric key, select the program number you want to move. Press the **ENT** key (Pressing the **TUNE** key toggles between the uppercase **P** and the lowercase **p**).

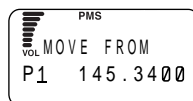

## 4 Select the desired destination program.

Using the dial or a numeric key, select the destination program number. Press the  $\text{ENT}^{\text{TF}}$  key (Pressing the  $\text{F TUNE}^{\text{F}}$  key toggles between the uppercase **P** and the lowercase **p**).

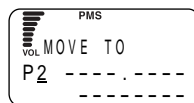

To retry the setting, press the  $\text{CLR}^{\text{SKIP}}$  key.

The display will return to the PMS EDIT menu. Point the arrow at **END** and then press the  $\text{ENT}^{\text{TF}}$  key (Alternatively, you may press the  $\text{F}^{\text{F}}$  key, and then press the  $\text{ENT}^{\text{TF}}$  key while **F** is shown on the display).

## 3.3.6 Deleting scan programs

This function deletes scan programs from the program banks.

### 1 Call up the PMS EDIT menu.

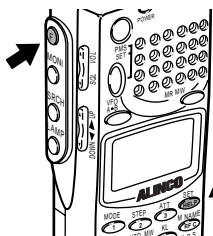

Press the  $\text{F}^{\text{F}}$  key, and then press the  $\text{SET HELP}^{\text{SET}}$  key while **F** is shown on the display.

The MENU will appear. Point the arrow at **+PMS** using the dial or **UP/DOWN** key, and then press the  $\text{ENT}^{\text{TF}}$  key.

The PMS menu will appear. Point the arrow at **+PMS EDIT** and then press the  $\text{ENT}^{\text{TF}}$  key. The PMS EDIT menu will appear.

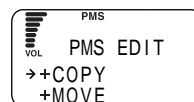

### 2 Call up the DEL screen.

Point the arrow at **+DEL** using the dial or **UP/DOWN** key, and then press the  $\text{ENT}^{\text{TF}}$  key.

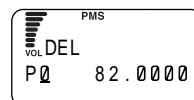

### 3 Select the program you want to delete.

Using the dial or a numeric key, select the program number you want to delete. Press the  $\text{ENT}^{\text{TF}}$  key (Pressing the  $\text{F TUNE}^{\text{F}}$  key toggles between the uppercase **P** and the lowercase **p**).

The display will return to the PMS EDIT menu. Point the arrow at **END** and press the  $\text{ENT}^{\text{TF}}$  key (Alternatively, you may press the  $\text{F}^{\text{F}}$  key, and then press the  $\text{ENT}^{\text{TF}}$  key while **F** is shown on the display).

## 3.4 MR mode functions

This section explains operations of the MR mode.

### 3.4.1 Memorizing frequencies

This function saves selected frequencies of memory channels.

#### 1 Set the frequency you want to memorize, in the VFO mode.

Press the  $\text{XFB}$  key to get the VFO mode. Then, set the frequency on the top line (currently used) band.

#### 2 Select the bank number to which you want to assign a frequency.

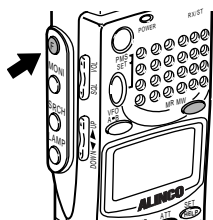

Press the  $\text{F}$  key, and then press the  $\text{MRMW}$  key while  $\text{F}$  is shown on the display.

The SET MR screen will appear.

Select the bank number using the dial or a numeric key, and then press the **DOWN** key (Pressing the  $\text{FTUNE}$  key toggles from the bank groups A through E).

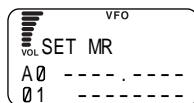

#### 3 Select a memory channel.

Using the dial or a numeric key, select the channel number to which you want to assign the frequency. Press the  $\text{TF ENT}$  key.

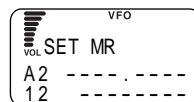

#### 4 Give a name to the memory channel.

Select each character by turning the dial, and then establish it by pressing the **DOWN** key. The established character can be canceled by pressing the **UP** key. Up to 8 characters may be entered for the name.

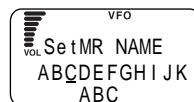

#### 5 Store the memory channel.

After you have finished entering the name, press the  $\text{TF ENT}$  key. The frequency will be assigned to the selected memory channel, and then the display will return to the VFO mode.



- Note:
- The settings for the radio, frequency step, attenuator, and CTCSS decoding function, which were completed in the VFO mode, will be stored on the memory channel.
  - In naming the memory channel, you can move 11 characters ahead by turning the dial while holding down the  $\text{F}$  key.

## 3.4.2 Setting the auto memory write function



This function is used to automatically assign a frequency that has been received during scanning in the PMS mode, to the memory bank.

### 1 Call up the scanning program.

Press the  key to enter the PMS mode. Select a program bank number. The programmed scanning will start.

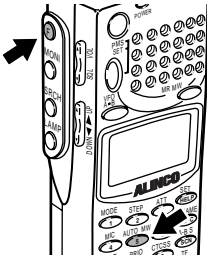
### 2 Set the auto memory write function.



Press the  key, and then press the  key while  is shown on the display.

The AUTO MEMORY WRITE (MR WR) screen will appear.

Point the arrow at **START** using the **UP/DOWN** key, and select a program bank using the dial.

Press the  key. The programmed scanning will start and the received frequency will be assigned to the automatically selected memory bank.



To stop the auto memory write function, point the arrow at STOP on the AUTO MEMORY WRITE (MR WR) screen, and then press the  key.





*Note: The settings for the modulation type, frequency step, attenuator, and CTCSS decoding function, which were completed in the PMS mode, will be stored on the memory channel.*



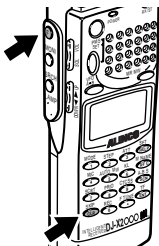

## 3.4.3 Setting memory scan skip

This setting specifies memory channels to be skipped while scanning in the MR mode. The memory scan will not stop on these frequencies even if a signal is present.

### • To skip memory channels



Press the  key to get the MR mode. Then set the memory channel where skip channels are to be set.

Press the  key, and then press the  key while  is shown on the display. (or press only the  key).

**SKIP** will be displayed to indicate the channel will be skipped during the memory scan.

Pressing the  key again will cancel the skip setting.

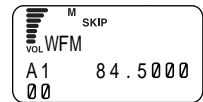







### 3.4.4 Setting memory scan radio system (MODE SEL)

By setting a mode in the "MODE SEL" menu, the DJ-X2000 will selectively scan the memory channels of the specified mode.

#### 1 Call up the MODE SEL screen.

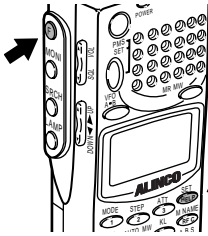

Press the **F** key, and then press the **SET** key while **F** is shown on the display.

The MENU will appear. Point the arrow at **+MR** using the dial or **UP/DOWN** key, and then press the **ENT** key.

The MR screen will appear. Point the arrow at **+MODE SEL** and then press the **ENT** key.

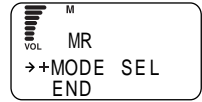

#### 2 Select the modulation mode you are scanning.

Using the dial or **UP/DOWN** key, point the arrow at the radio type you are scanning. Press the **ENT** key. The radio type can be selected from ALL, AM, NFM, WFM, USB, LSB, and CW. If **ALL** is selected, all the channels will be scanned regardless of the modulation mode (the initial setting is **ALL**).

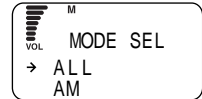

The display will return to the MR screen. Point the arrow at **END** and then press the **ENT** key (Alternatively, press the **F** key, and then press the **ENT** key while **F** is shown on the display).



### 3.4.5 Using the Bank Link function

This function lets you scan specific memory banks.

#### 1 Call up the Bank Link screen.

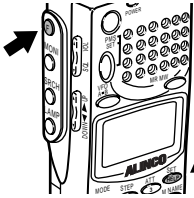

Press the **F** key, and then press the **SET/HELP** key while **F** is shown on the display.



The MENU will appear. Point the arrow at **+MR** using the dial or **UP/DOWN** key, and then press the **ENT** key.

The MR menu will appear. Point the arrow at **+MR LINK** and then press the **ENT** key.

The MR Bank Link screen will appear.

#### 2 Select the memory bank you want to use for scanning.

Using a numeric key, specify the bank number you want to link. Pressing the **F TUNE** key toggles from bank groups A through E. To use all the memory banks for scanning, select all the banks 0 through 9. After you have finished specifying the bank(s), press the **ENT** key.

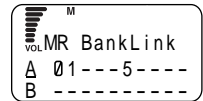

The display will return to the MR screen. Point the arrow at **END** and then press the **ENT** key (Alternatively you may press the **F** key, and then press the **ENT** key while **F** is shown on the display).

### 3.4.6 Selecting memory channels for scanning

Only the specified memory channels can be used for scanning. Up to 200 memory channels (20 programs x 10 banks) may be specified for scanning. To perform scanning on the memory channels, press the **F** key, and then press the **A-B S** **SCN** key while **F** is shown on the display.

#### 1 Call up the PMR menu.

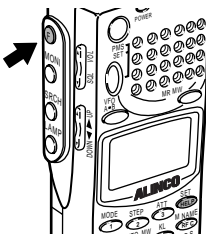

Press the **F** key, and then press the **SET/HELP** key while **F** is shown on the display.



The MENU will appear. Point the arrow at **+MR** using the dial or **UP/DOWN** key, and then press the **ENT** key.

The MR menu will appear. Point the arrow at **+PMR** and then press the **ENT** key.

The PMR menu will appear.

## 2 Select the program bank in which you want to set a memory channel for scanning.

Using the dial or **UP/DOWN** key, point the arrow at the program you want to set. Press the **ENT** key.

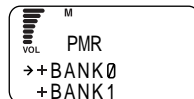

## 3 Select the program number you want to assign to a memory channel.

Using the dial or **UP/DOWN** key, point the arrow at the program number you want to select. Press the **ENT** key.

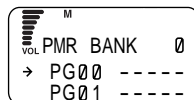

## 4 Select a memory bank.

Select a memory bank and then press the **ENT** key. Using the dial or a numeric key, specify a memory bank number (Pressing the **F TUNE** key toggles from bank groups A through E). Move the arrow back to the position pointing at the channel by pressing the **DOWN** key.

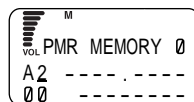

## 5 Select a memory channel.

Using the dial or a numeric key, specify a memory channel number. Press the **ENT** key (To cancel the setting, press the **SKIP CLR** key).

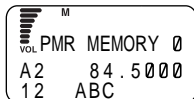

Repeat the above steps 2 through 5 to register all the channels on which you are scanning, and then press the **ENT** key.

The display will return to the PMR BANK screen. Point the arrow at **END** and then press the **ENT** key (Alternatively you may press the **F** key, and then **ENT** key while **F** is shown on the display).

### 3.4.7 Scanning the memory channels selected in the PMR screen

This function is used to scan only the memory channel selected on the PMR screen (See "3.4.6 Selecting memory channels for scanning" (page 72)).

- **Scanning only the memory channels selected on the PMR screen.**

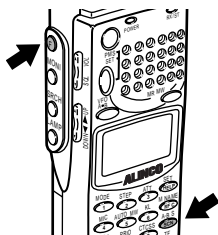

Press the **F** key in the MR mode, and then press the **A-B-S (SCN)** key while **F** is shown on the display. Only the channels selected on the PMR screen will be scanned. The scanning direction can be changed using the dial or **UP/DOWN** key.

- **Stopping the scan**

Press the **A-B-S (SCN)** key again. The scanning will stop.

### 3.4.8 Copying memory banks

This function copies channels from one memory bank to another.

**1** Call up the MR EDIT menu.

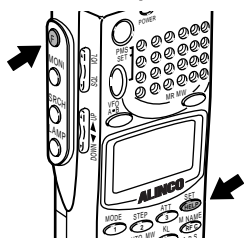

Press the **F** key, and then press the **SET (HELP)** key while **F** is shown on the display.

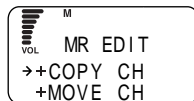

The MENU will appear. Point the arrow at **+MR** using the dial or **UP/DOWN** key, and then press the **TF (ENT)** key.

The MR menu will appear. Point the arrow at **+MR EDIT** and then press the **TF (ENT)** key. The MR EDIT menu will appear.

**2** Call up the COPY BANK screen.

Point the arrow at **+COPY BANK** using the dial or **UP/DOWN** key, and then press the **TF (ENT)** key.

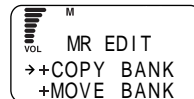

### 3 Select a source memory bank.

Using the dial or a numeric key, select the bank number you want to copy. Press the **TF ENT** key (Pressing the **F TUNE** key toggles from bank groups A through E).

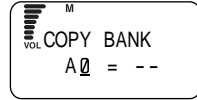

### 4 Select a destination memory bank.

Using the dial or a numeric key, select the bank number to which you want to copy the source memory bank. Press the **TF ENT** key (Pressing the **F TUNE** key toggles from bank groups A through E).

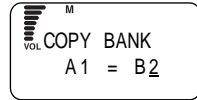

To retry the setting, press the **SKIP CLR** key.

The display will return to the MR EDIT menu. Point the arrow at **END** and then press the **TF ENT** key (Alternatively you may press the **F** key, and then press the **TF ENT** key while **F** is shown on the display).

## 3.4.9 Copying memory channels

This function copies the contents of one memory channel to another.

### 1 Call up the MR EDIT menu.

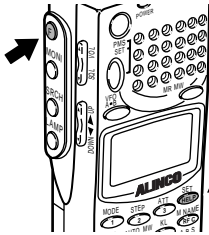

Press the **F** key, and then press the **SET HELP** key while **F** is shown on the display.

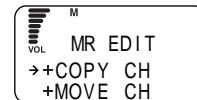

The MENU will appear. Point the arrow at **+MR** using the dial or **UP/DOWN** key, and then press the **TF ENT** key.

The MR menu will appear. Point the arrow at **+MR EDIT** and then press the **TF ENT** key.

The MR EDIT menu will appear.

### 2 Call up the COPY CH screen.

Point the arrow at **+COPY CH** using the dial or **UP/DOWN** key, and then press the **TF ENT** key.

### 3 Select the bank that includes the memory channel to be copied.

Select the bank number using the dial or a numeric key (Pressing the **F TUNE** key toggles from bank groups A through E). Move the arrow to the position pointing at the channel by pressing the **DOWN** key.

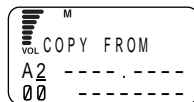

### 4 Select the memory channel you are copying.

Using the dial or a numeric key, select the channel number you are copying. Press the **TF ENT** key.

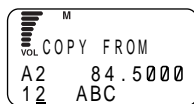

### 5 Select the bank that includes the destination memory channel.

Using the dial or a numeric key, select the bank number (Pressing the **F TUNE** key toggles from bank groups A through E). Move the arrow to the position pointing at the channel by pressing the **DOWN** key.

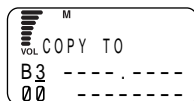

### 6 Select the destination memory channel.

Select the destination channel number using the dial or a numeric key, and then press the **TF ENT** key.

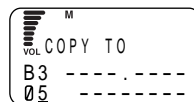

To retry the setting, press the **SKIP CLR** key.

The display will return to the MR EDIT menu. Point the arrow at **END** and then press the **TF ENT** key (Alternatively you may press the **F** key, and then press the **TF ENT** key while **F** is shown on the display).

## 3.4.10 Moving a memory bank

Any channel assigned to a memory bank can be moved to another memory bank.

### 1 Call up the MR EDIT menu.

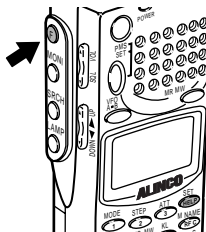

Press the **F** key, and then press the **SET HELP** key while **F** is shown on the display.

The MENU will appear. Point the arrow at **+MR** using the dial or **UP/DOWN** key, and then press the **TF ENT** key.

The MR menu will appear. Point the arrow at **+MR EDIT** and then press the **TF ENT** key.

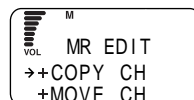

## 2 Call up the MOVE BANK screen.

Point the arrow at **+MOVE BANK** using the dial or **UP/DOWN** key, and then press the **TF ENT** key.

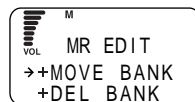

## 3 Select the memory bank you want to move.

Using the dial or a numeric key, select the memory bank you want to move. Press the **TF ENT** key (Pressing the **F TUNE** key toggles from bank groups A through E).

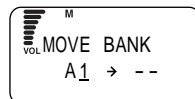

## 4 Select the destination memory bank.

Select the destination bank number using the dial or a numeric key, and then press the **TF ENT** key (Pressing the **F TUNE** key toggles from bank groups A through E).

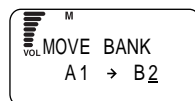

To retry the setting, press the **SKIP CLR** key.

The display will return to the MR EDIT menu. Point the arrow at **END** and then press the **TF ENT** key (Alternatively you may press the **F** key, and then press the **TF ENT** key while **F** is shown on the display).

### 3.4.11 Moving a memory channel

This function is used to move the frequency and name assigned to a memory channel to another memory channel.

#### 1 Call up the MR EDIT menu.

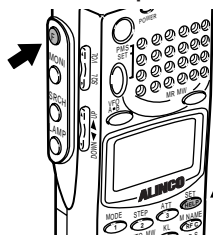

Press the **F** key, and then press the **SET (HELP)** key while **F** is shown on the display.

The MENU will appear. Point the arrow at **+MR** using the dial or **UP/DOWN** key, and then press the **TF ENT** key.

The MR menu will appear. Point the arrow at **+MR EDIT** and then press the **TF ENT** key. The MR EDIT menu will appear.

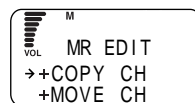

## 2 Call up the MOVE CH screen.

Point the arrow at **+MOVE CH** using the dial or **UP/DOWN** key, and then press the  key.

## 3 Select the bank that includes the memory channel you want to move.

Select the bank number using the dial or a numeric key (Pressing the  key toggles from bank groups A through E). Move the arrow to the position pointing at the channel by pressing the **DOWN** key.

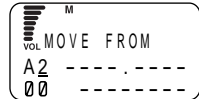

## 4 Select the memory channel you want to move.

Using the dial or a numeric key, select the channel number you want to move. Press the  key.

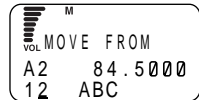

## 5 Select the bank that includes the destination memory channel.

Select the bank number using the dial or a numeric key (Pressing the  key toggles from bank groups A through E). Move the arrow to the position pointing at the channel by pressing the **DOWN** key.

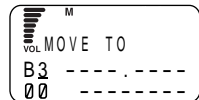



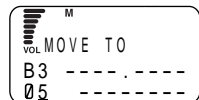

## 6 Select the destination memory channel.

Select the destination channel number using the dial or a numeric key, and then press the  key.



To retry the setting, press the  key.

The display will return to the MR EDIT menu. Point the arrow at **END** and then press the  key (Alternatively you may press the  key, and then press the  key while  is shown on the display).

## 3.4.12 Deleting memory banks

This function deletes entire memory banks.

### 1 Call up the MR EDIT menu.

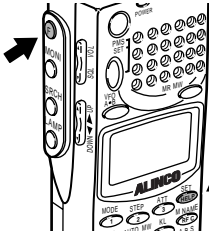

Press the  $\text{P}$  key, and then press the  $\text{SET}$  (HELP) key while  $\text{F}$  is shown on the display.

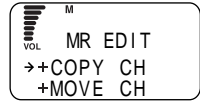

The MENU will appear. Point the arrow at **+MR** using the dial or **UP/DOWN** key, and then press the  $\text{TF}$  (ENT) key.

The MR menu will appear. Point the arrow at **+MR EDIT** and then press the  $\text{TF}$  (ENT) key. The MR EDIT menu will appear.

### 2 Call up the DEL BANK screen.

Point the arrow at **+DEL BANK** using the dial or **UP/DOWN** key, and then press the  $\text{TF}$  (ENT) key.

The DEL BANK screen will appear.

### 3 Select the memory bank you want to delete.

Using the dial or a numeric key, select the bank number you want to delete. Press the  $\text{TF}$  (ENT) key (Pressing the  $\text{F}$  TUNE key toggles from bank groups A through E).

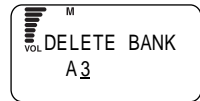

The display will return to the MR EDIT menu. Point the arrow at **END** and then press the  $\text{TF}$  (ENT) key (Alternatively you may press the  $\text{P}$  key, and then press the  $\text{TF}$  (ENT) key while  $\text{F}$  is shown on the display).



### 3.4.13 Deleting and restoring memory channels

This function is used to delete and restore the frequency and name assigned to a memory channel.

#### 1 Call up the MR EDIT menu.

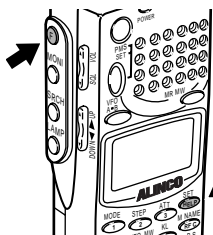

Press the **F** key, and then press the **SET** (HELP) key while **F** is shown on the display.

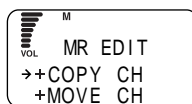

The MENU will appear. Point the arrow at **+MR** using the dial or **UP/DOWN** key, and then press the **ENT** key.

The MR menu will appear. Point the arrow at **+MR EDIT** and then press the **ENT** key. The MR EDIT menu will appear.

#### 2 Call up the DEL CH screen.

Point the arrow at **+DEL CH** using the dial or **UP/DOWN** key, and then press the **ENT** key.

#### 3 Select the bank that includes the memory channel you want to delete.

Select the bank number using the dial or a numeric key (Pressing the **F TUNE** key toggles from bank groups A through E). Move the arrow to the position pointing at the channel by pressing the **DOWN** key.

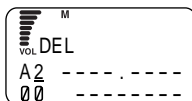

#### 4 Select the memory channel you want to delete.

Using the dial or a numeric key, select the channel you want to delete. Press the **ENT** key (Pressing the **F TUNE** key toggles from bank groups A through E).

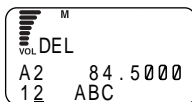

To retry the setting, press the **SKIP CLR** key.

The display will return to the MR EDIT menu. Point the arrow at **END** and then press the **ENT** key (Alternatively you may press the **F** key, and then press the **ENT** key while **F** is shown on the display).

#### • Restoring the deleted memory channel

The memory channel you have deleted can be restored. As in the above steps, call up the channel number you have deleted, and then press the **ENT** key. The previously stored channel will be restored.



*Note: If any other frequency is already assigned to the once deleted channel, the previous channel data cannot be restored.*



# 4. Appendix

## 4.1 Specifications

<b>Range of received frequencies</b>	0.1MHz ~ 2149.999950MHz	
<b>Received radio type</b>	WFM, NFM, AM, USB, LSB, CW	
<b>Frequency steps</b>	AUTO STEP, 50Hz, 100Hz, 200Hz, 500Hz, 1kHz, 2kHz, 5kHz, 6.25kHz, 8.33kHz, 9kHz, 10kHz, 12.5kHz, 15kHz, 20kHz, 25kHz, 30kHz, 50kHz, 100kHz, 125kHz, 150kHz, 200kHz, 250kHz, 500kHz, USER STEP (Only the digits of 1 MHz, 10 MHz, and 100 MHz can be changed.)	
<b>Receiving sensitivity</b>  Excluding the frequency band for electric communication business use  The typical sensitivity values are shown here.	0.1MHz ~ 5MHz	AM 1.5 $\mu$ V (10dB S/N) SSB/CW 0.6 $\mu$ V (10dB S/N)
	5MHz ~ 900MHz	AM 1.0 $\mu$ V (10dB S/N) SSB/CW 0.5 $\mu$ V (10dB S/N) NFM 0.5 $\mu$ V (12dB SINAD) WFM 2.0 $\mu$ V (12dB SINAD when stereo signal are received)
	900MHz ~ 2150MHz	SSB/CW 1 $\mu$ V (10dB S/N) NFM 2 $\mu$ V (12dB SINAD) WFM 4 $\mu$ V (12dB SINAD)
<b>Memory channel</b>	2,000 channel	
<b>Search path memory</b>	1,000 channel	
<b>Priority channel</b>	1 channel (freely selectable from 2,000 channels)	
<b>Memory banks</b>	50	
<b>1-bank channel</b>	40	
<b>Band search</b>	20	
<b>Antenna connector</b>	BNC,50	
<b>Power source</b>	4.8V DC (Ni-Cd), 7.2V DC (Ni-Cd), 6V DC (AA battery)	
<b>External power source</b>	10 ~ 16V DC	
<b>Rated output</b>	min.100 mW, 10% THD	
<b>Current consumption</b>	At rated output: Approx. 150 mA (when 6 V power source is used) At standby: Approx. 100 mA In BS mode: Approx. 50 mA	
<b>Weight</b>	Approx. 200 g	
<b>External dimensions</b>	57 x 150 x 27.5mm	
<b>Operating temperature</b>	-10°C ~ 50°C(14°F ~ 122°F)	

Note: The North American version cannot be used to receive any frequency for cellular phones.

## 4.2 Troubleshooting

Trouble	Cause	Remedial action
No sound is heard from the speaker.	The volume level is too low.	Press the VOL key on the left side of the DJ-X2000, and then turn up the volume (see page 19).
	The squelch level is too high.	Press the SQL key on the left side of the DJ-X2000, press the DOWN key to decrease the level until any noise can be heard, and then increase the level until the noise is no longer heard (see page 20).
No signal can be received.	The antenna is not properly set.	Properly attach the antenna (see page 13).
The settings for frequencies, etc. cannot be performed.	The key locking function is active.	Cancel the key locking function (see page 27).
The warning beep is emitted or the sound is distorted. The display turns OFF.	The battery has run out.	When <b>B</b> appears on the display, replace the battery.

## 4.3 Optional items

The optional items available for the DJ-X2000 are listed below:

- EBP-33N NiCd battery pack (4.8V 650mA)
- EBP-34N NiCd battery pack (4.8V 1200mA)
- EBP-35N NiCd battery pack (7.2V 900mA)
- EBP-37N NiCd battery pack (4.8V 700mA)
- EDC-36 Cigarette lighter cable with active filter
- EDC-88 Rapid recharger (120/230VAC)
- EME-6 Earphone
- ESC-28 Soft case (for use with EBP-33N)
- ESC-29 Soft case (for use with EBP-37N)
- ESC-30 Soft case (for use with EBP-34N or EBP-35N)
- EBC-6 Mobile bracket
- EDC-37 DC cable for station use

## 4.4 List of Help menu items

The list of Help menu items is given below. For the items marked with ● in the column for "Function involved", when the  $\text{ENT}^{\text{TF}}$  key is pressed, the currently displayed function or setting is executed.

For the operation procedure for the Help menu, see "2.15 Using Help menu" (page 31).

### Organization of Help menu

<b>Help</b>	Describes how to use the Help information. Point the arrow at HELP and then press the $\text{ENT}^{\text{TF}}$ key.
<b>Keys</b>	Describes each key. Point the arrow at +KEY and then press the $\text{ENT}^{\text{TF}}$ key.
<b>Function</b>	Describes the operation procedure for each function. Point the arrow at +FUNCTION and then press the $\text{ENT}^{\text{TF}}$ key.

### Keys

Menu	Function involved	Operational explanation available
[SET]		
[POWER]		
[DIAL]		
[VOL]		
[SQL]		
[F]		
[MONI]		
[F]&[MONI]		
[LAMP]		
[SRCH]		
[F]&[SRCH]		
[VFO]		
[A=B]		
[MR]		
[MW]		
[PMS]		
[ENT]		
[CLR]		

Menu	Function involved	Operational explanation available
[SCN]		
[RF C]		
[.]		
[MODE]		
[STEP]		
[ATT]		
[MIC]		
[AUTO MW]		
[KL]		
[M NAME]		
[PRIO]		
[CTCSS]		
[A ~ B S]		
[SKIP]		
[REC]		
[F TUNE]		
[TF]		
[SCRT]		

## Functions

Menu	Submenu	Function involved	Operational explanation available
VFO	Inst		
	COPY A=B		
	COPY MR. CH		
	COPY PMS		
MR	Inst		
	COPY CH		
	DEL CH		
	COPY BANK		
	DEL BANK		
	MR LINK		
	MODE SEL		
	SCAN SKIP		
	SET CTCSS		
M. TUNE			
PMS	Inst		
	SCAN PASS		
	COPY		
	DEL		
	PMS LINK		
	AUTO MR WR		
SCAN	VFO		
	MR		
	A ~ B S		
	MODE SCAN		
	PMR SCAN		
	VFO LINK		
	S_LEVEL		
	CTCSS SCAN		
	SCAN SETUP	SCAN MODE BUSY Timer RX Timer	
SRCH MODE	SINGLE		
	INTERVAL		
	CONTINUE		
	SET		



Menu	Submenu	Function involved	Operational explanation available	
LAMP	AUTO			
	MOMENTARY			
	ALTERNATE			
	Inst			
TIMER				
BEEP				
tone				
STEREO				
BELL				
BATT SAVE				
BATT VOLT				
LANGUAGE	Japanese			
	English			
	SET			
DIRECT WR				
MESSAGE				
CLONE	Inst			
	TX CLONE			
	RX CLONE			
CTCSS SET	MANUAL			
	REVERSE			
	SET			
RESET	SYSTEM			
	ALL			
SPECIAL	A/B SQ SET			
	FLASH TUNE			
	RF CHECK	CHECKER		
		CallWait		
	REC	RX AF		
		MIC		
		SET		

# **ALINCO, INC.**

**Office: "TWIN 21" MID Tower Building 25F  
1-61, 2-chome, Shiromi, Chuo-ku, Osaka, 540-8580, JAPAN  
Phone: 06-6946-8150 Fax: 06-6946-8175  
E-mail: [export@alinco.co.jp](mailto:export@alinco.co.jp)**