

TLM-202 V2

USER'S MANUAL

VHF TRANSCEIVER FOR AMATEUR USERS

VHF 144 - 146 MHz

CE 0700 !



www.luthor.es

We want to appreciate the confidence shown by purchasing this mobile transceiver LUTHOR TECHNOLOGIES model TLM-202 V2. This transceiver offers an innovative design in terms of technology and multi-functionality. Its high quality and extensive features make it one of the best equipments in its field, we trust in your total satisfaction with your expectations and communication needs.

Please read carefully the following manual before using the transceiver in order to guarantee the maximum performances. The use of the symbol  shows that this equipment it's under use restrictions in certain countries.

Countries where the use of this equipment is permitted:

AUT	BELC	HE	CYP	CZE	DEU	DNK	ESP
EST	FINF	RA	GBR	GRC	HUN	IRLI	SL
ITAL	IE	LTU	LUXL	VL	MLTN	LD	NOR
POLP	RT	SVKS	VN	SWE			

Cautions and practical advices

- Do not use the transceiver if you are driving a vehicle. To prevent accidents, focus only on driving.
- This transceiver is designed for a power supply maximum voltage of 13,8 volts. Do not use a battery with 24 volts to supply power to the transceiver.
- Do not place the transceiver on excessively dusty or wet areas, nor on unstable surfaces.
- Please, keep it away from interfering devices such as televisions, generators, etc.
- Avoid exposing the transceiver to the sun for long periods of time, or installing it nearby heating devices.
- If the transceiver emanates an strange smell or smoke, turn off the device immediately. Get in contact with your dealer.
- Avoid to transmit for long periods of time with the maximum power, the transceiver should overheat.

Contents index

- Cautions and practical advices page 2
- New functions..... page 5-6
- Main features and functions page 7-8
- Supplied accessories page 9
- Optional accessories page 10
- Installation..... page 11-21
- Accessories installation..... page 22-24
- Transceiver's description..... page 25
- Keys functions page 26-29
- Introduction to display's icons page 30-31
- Transceiver's operating modes page 32-37
- Basic functions page 38-44
- Quick access to functions through keypad page 45-51
- Function's detailed descriptions page 52-80
- Microphone functions..... page 81-90

- Cloning cable..... page 91-92
- Troubleshooting guide page 93-94
- Technical specifications page 95-96
- Table of analogical CTCSS tones..... page 97
- Table of digital DCS tones..... page 98-101
- Environment protection note..... page 102
- Declaration of conformity page 103

New functions

A transceiver with a double personality (read carefully this section before start operating with it)

In effect, the mobile transceiver LUTHOR TECHNOLOGIES TLM-202, it is manufactured using the best and more advanced technology in its sector. A modern and attractive design with a robust cage and a radiator with the same level as the most professionals, has on its inside the technology capable to offer the double personality mentioned on the statement.

The first is an easy and functional use personality, with the features and functions of any other radio of the amateur sector, allows a quick way use for the most unfamiliar users with the radio world, through an access to the configuration menus by the transceiver or the microphone's keypad. Using it on the car, 4x4, at home, etc. will be a really great experience.

The second personality is intended for the most advanced users. The transceiver provides a series of features with a really high-end technological level that in most cases requires the use of both the programming software and the programming cable (sold as an optional accessory) to connect it to the computer; that requires an advanced user and also a good knowledge in the configuration of this kind of parameters, of its meaning and its use, like are the DTMF or more complex in the case of the 5-tone and 2-tone. On this manual, all the transceiver's aspects and configurations are explained, but with this second case where the menus or configurations require an advanced level of understanding and the use of the software and the programming cable, we declare at the beginning of the sentence: **“For advanced users, requires software and programming cable”**.

Main features and functions

- Elegant and robust design where a big dimension and specially designed radiator is introduced, in order to dissipate to the maximum the heat produced by the powerful 60 watts of power that this transceiver is able to supply.
- Quick access buttons to the most important functions.
- Hand microphone with keypad.
- Backlit display to guarantee a correct screen display in dark conditions. With the chance to select three different background colours.
- 200 programmable memory channels with the capability to edit a name for a better identification.
- “Compander” function for a background noise reduction and an improvement of the audio quality.
- Scrambler function: a very practical function introduced on only a few transceivers. Gives a really high level of privacy to the conversations.
- Cloning function to copy data from one station to another.
- Special functions (only recommended for advanced users, requiring the software and

the programming cable).

- Programming through software and PC interface for all the parameters, frequencies, memories, etc.
- DTMF, 5-tone, 2-tone functions: for sending messages, emergency alarms, calling to all, calling identification, ANI, etc. (only through the programming software and a programming cable for PC)



Supplied accessories

Carefully unpack the transceiver's package content. We recommend you to identify the items listed in the following table before discarding the packing material. If any items are missing or have been damaged during shipment, please contact your dealer as soon as possible.



TLM-202 transceiver



Microphone with keypad
ref: TLMK-16



Mounting bracket
ref: TLMS-4



DC Power cord with
fuse ref: TLMC-2



Screws
(M4x8mm, M5x8mm)



User's manual



Washers



Fuses

Optional accessories



Cloning cable
ref: TLCLONE202



Programming cable
ref: TLUSB109



Cigarette-lighter cable



Programming software

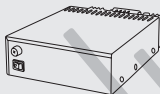

Power supply
ref: MPS2025



Desktop microphone



Car antenna



External speaker
ref: SP80

Installation

To install the transceiver, look for a suitable and secure location inside your vehicle to reduce the risks for the passengers and yourself while the vehicle is in movement. Consider to install the station in an appropriate position so that your knees and your legs will not be able to hit it during a sudden braking manoeuvre of your vehicle. Try to select a well-ventilated location that keeps it protected from direct sunlight.

1. Install the mounting bracket on your vehicle using the self-tapping screws supplied (4 units) and the spring washer (4 units).

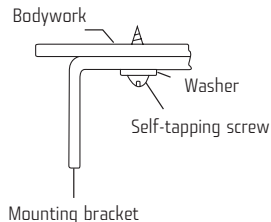
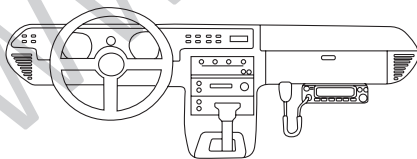
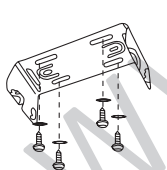

2. Place the transceiver and then insert and tighten the supplied hexagon head cap screws. Make sure that all the screws will be properly tightened to prevent that the vehicle vibrations loosen the screws.

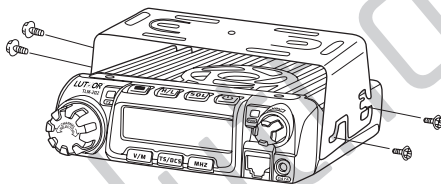

Determine the appropriate angle for the transceiver using the three possible positions for the rear screw on the mounting bracket lateral.

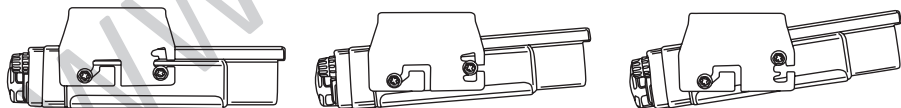

Connection for the power cable

NOTE: place the power on connector so close as possible to the transceiver.

Installation as a mobile station

The vehicle's battery must be a 12 volts battery. Never connect the transceiver to a 24 volts battery. Make sure to use a 12 volts vehicle battery which has enough power capacity. In case that the power arriving to the transceiver is not enough, the display could turn dark during the transmission, or the output power when transmitting could excessively go down.

1. Route the power cable supplied from the transceiver directly to the vehicle battery terminals using the shortest possible path.
 - We recommend you not to use the cigarette lighter socket as a power source due to some of them may have unacceptable voltage drops.
 - The power cable routing must be installed in a way that it remains isolated from heat, humidity and the engine's ignition system and its cables.
2. With the goal of avoiding the risks of short-circuiting, please, disconnect the

negative [-] cable from the battery before connecting the transceiver.

3. Confirm the right polarization from the connections, then fix the power cord to the battery terminals; the red cable must be connected to the positive [+] terminal, and the black cable must be connected to the negative [-] terminal.
 - Use the total cable length without cutting the surplus cable even if the cable is longest than necessary.

BEWARE: never remove the fuse container from the cable.

4. Connect again the negative [-] cable from the battery.

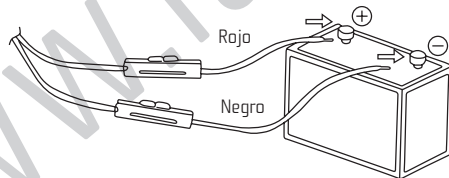

5. Connect the supplied power cable to the transceiver's power connector.
 - Press firmly the connectors until the locking flanges snap.

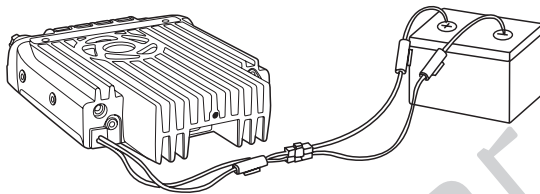

In case you want to use the power on/off function through the vehicle's ignition key (optional), use the optional cigarette-lighter cable. Connect one of the cables between the ACC terminal or one cigarette-lighter plug or a power switch from the vehicle and the "EXT POWER" connector on the back side of the transceiver.

NOTE: in many vehicles, the cigarette-lighter plug always has current. If this is the case, you could not use it for the power on/off function through the vehicle's ignition key.

6. When the ignition key turns to the ON position with the transceiver turned off, the power on button will switch on. The power button will turn off when the ignition key turns to the OFF position.

To power on the transceiver, press the power on button while it is illuminated.

(While the ignition key is into the ON position).

- When the ignition key is into the ON position and the power on button is also into the ON position, the station will automatically turn on and the power on button will illuminate. Turn the ignition key to the OFF position or press the power on button manually to turn off the transceiver.
- Without using this function, is possible to turn the radio on or off through the power on button of the radio.

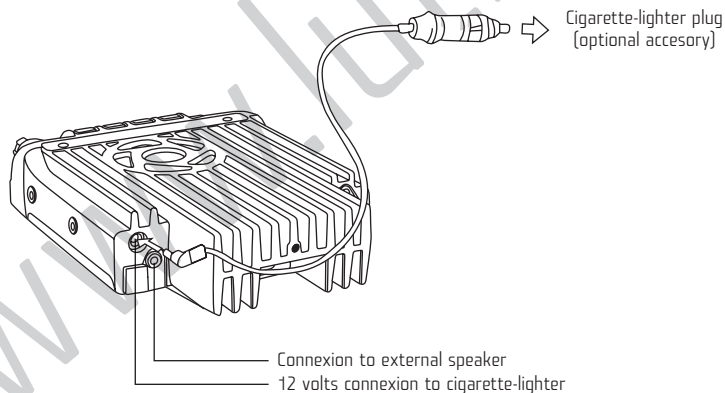

Installation as a fix station

A 13,8V DC power supply (optional, not supplied) is required. Please, contact your dealer.

The current recommended for the power supply is 15A.

1. Connect the power cord to the output terminals on the power supply and make sure the polarity is right. (Red: positive; Black: negative).
 - Do not connect the transceiver directly to a wall outlet.
 - Use the supplied power cord to connect the transceiver to a switching power supply.
 - Do not replace the supplied power cord for another one with a smaller wire size.

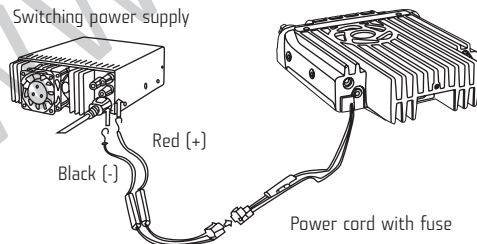

2. Connect the supplied power cord plug to the transceiver's power connector.
 - Press firmly the connectors until the locking flanges snap.

NOTE: before connecting the power cord to the transceiver, make sure to turn off both the transceiver and the power supply.

Replacing the fuses

If a fuse has blown, determine the cause, and then correct the problem. After solving the problem, replace the fuse. If the new installed fuse blows, disconnect the power cord and contact your dealer or an authorised technical service.

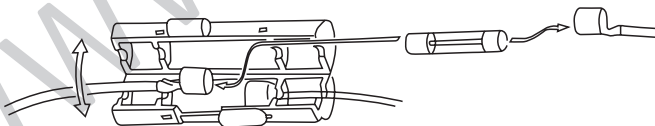



Fuse location	Fuse amperage
Transceiver	15A
Supplied power cord	20A

Use only fuses of the same type and amperage specified, in any other case the transceiver could be damaged.

NOTE: if you use the transceiver during a long period of time when the vehicle's battery is not fully charged, or when the engine is off, the battery could fully discharge, and maybe will not have enough reserve to start the vehicle. Avoid using the radio under those circumstances.

Displaying the input voltage

After connecting the transceiver to the power supply and once the radio is on, the input voltage can be viewed on the screen by pressing the  button, the  icon will be shown on the screen, then press the  button. The information on the screen change immediately while the input voltage change, additionally shows the

voltage during a transmission.

The transceiver will return to the normal mode of operation repeating the steps previously described.



13.8V

Important: the voltage range showed is only between 7V and 16V DC, because the value shown is estimated, please, use a voltmeter when you wish a more accurate voltage reading.

Antenna connection

Before using the transceiver, install a suitable antenna. The success of the installation will largely depend on the antenna type and its right installation. The transceiver could give excellent results if particular attention is paid to antenna's system and its installation.

Use an antenna with a VHF frequency range with an impedance of 50 Ω to match

the transceiver's input impedance. Connecting the antenna to the transceiver through power lines with an impedance different of 50Ω , the efficiency of the antenna system is reduced and can cause interferences to any other nearby equipment like televisions, radio receptors and other electronic equipments or even the breakdown of your own transceiver.

NOTE: transmitting without connecting any antenna or another equivalent charge can damage the transceiver. Always connect the antenna to the transceiver before transmitting.

The possible placements for the antenna on the car are the next ones:

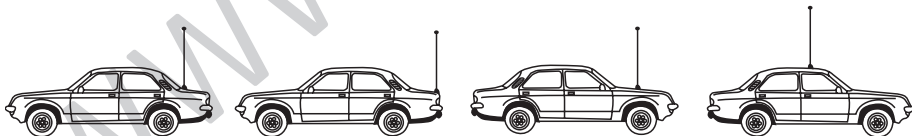

Accessories installation

External speaker (optional)

In case you want to use an external speaker, it is recommended that you choose one with an impedance of 8 Ω . The connector for external speaker accepts connections of 3,5mm (1/8") mono.

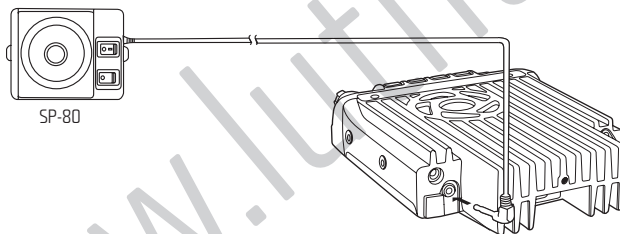

Image 1

NOTE: the speaker can not connect with the ground connection, otherwise the speaker could be damaged. The connection method showed on image 2 is wrong.

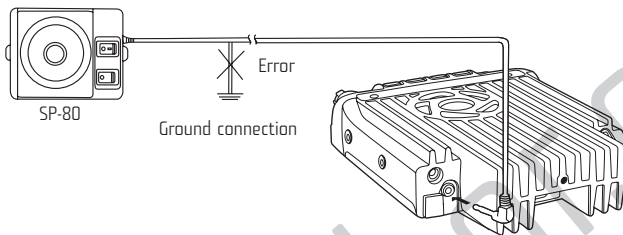
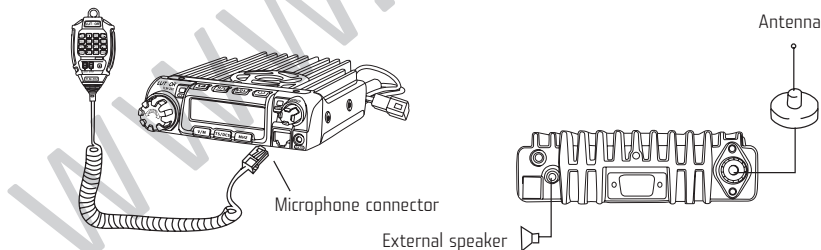

Image 2

Microphone

For voice communications, connect a microphone equipped with an 8-pin modular connector on the modular connector located on the front of the station. Press firmly the connectors until the locking flanges snap. Fix the supplied microphone on a proper place using the supplied screws.



PC connection

To use the optional software, firstly you must connect the transceiver to your PC using the programming cable TLUSB109 (optional).

Please, use only the original programming software.

NOTE: contact your dealer for buying the programming cable.





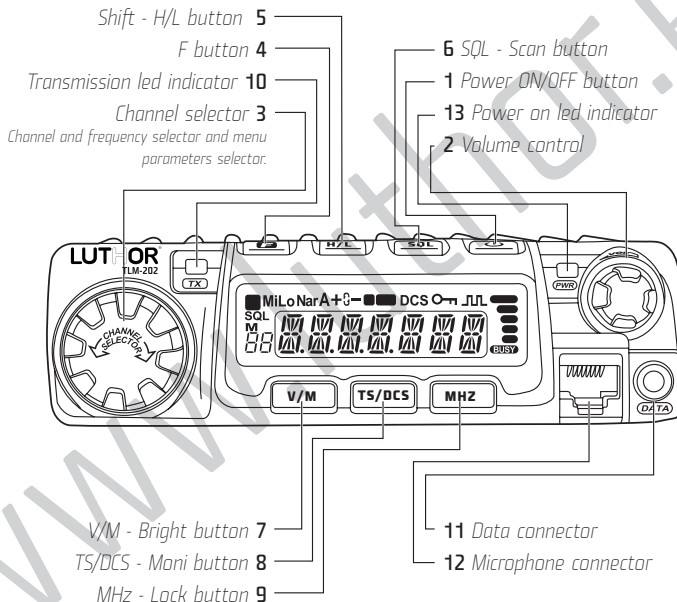

Transceiver's description

Frontal view







Keys functions



Basic functions











No.	Button	Función
1		Turning on/off the transceiver.
2	Volume	Control for adjusting the volume.
3	Channel selector	Frequencies, shannel memories,... selector
4		Button for accessing the secondary functions.
5		Power transmission: high, medium or low.
6		Squelch sensibility level.
7		Selection between VFO and memory modes.
8		Selection of CTCSS / DCS tones.
9		Selection of 1 MHz frequency step.
10	Transmission indicator	IRed colour led for transmission indication.
11	Data connector	With the programming cable: data reading/writing, cloning, alarm functions.

12	Microphone connector	Connector for the microphone.
13	Power on led indicator	Led for operation indication.

Keep pressing (during 1 second) the following buttons to access those secondary functions:

No.	Tecla	Función
5		SHIFT: frequency shift direction (+,-).
6		SCAN: for enabling the frequencies scanning function.
7		BRIGHT: for adjusting the LCD display brightness.
8		MON: monitor function for disabling the squelch.
9		LOCK: lock or unlock the station and microphone keypads.

Press the  button, the  icon will be showed on the display, sthen press the following buttons to access those secondary functions:

No.	Tecla	Función
5	 + 	CLONE: cloning function.*
6	 + 	For enabling the Compander function.
7	 + 	Copy channel
8	 + 	Delete channel
9	 + 	Shows the present battery voltage.

*WARNING: if you press the “Clone” option without having the stations ready for cloning, the transceiver will remain blocked and you should power off and then power on through the  button, that will remain as the only operating button.

Back view

External power connector:

Connection for an optional cable:
*power on/off function through the
vehicle's ignition key.*

External speaker connector:

Connection for external optional
speaker.

Antenna connector:

PL female connector for a VHF 50 Ω
antenna.

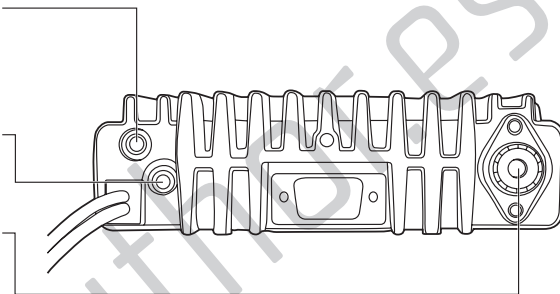

Microphone (ref. TLMK-16)

DOWN button

Decreases the frequency, channel or
adjust value.

PTT button

Press to transmit and release to
receive when your transmission is
completed.

LOCK ON/OFF

Lock or unlock the microphone
keypad.

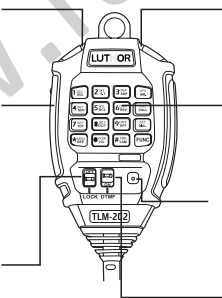

UP button

Increase the frequency, channel or
adjust value.

Numeric keypad

Keypad for access to functions or
introducing frequencies.

Microphone

Captures your voice for transmission.

DTMF ON/OFF









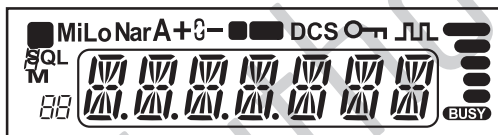









Activates the DTMF.





Introduction to display's icons

When the transceiver is powering on you can see different icons appearing on the display.

The following table will help you to identify the meaning of the display's icons.



SQL	Squelch filter activated.
M 	Channel mode activated.
 	Channel / Memory / Menu numbering.
   	Decimal point indicating that the channel skip is activated.
    	Decimal point for the tuned frequency.
    	Indicates the frequency or the memory name.
BUSY	indicates there is a receiving signal.
	Componder function activated.

	Key pad lock activated.
DCS	Digital DCS tone activated.
	Analogical CTCSS tone activated.
+ -	Shows the frequency shift direction.
	Encryption function activated.
A	Automatic power off function activated.
Nar	Narrow band activated.
LO	Low power activated.
Mi	Medium power activated.
	Access to secondary functions.
	Shows the RX and TX signal power.

Transceiver's operating modes

The TLM-202 transceiver offers the possibility for operating with four different modes, choose the one more suitable for you or toggle between the different possibilities to enjoy your transceiver. According to the mode you choose the display will show different looks.

The selection for the operating mode can be made in three ways:

- Through the transceiver's menu number 26 (see page 76).
- Through the programming software (requires the optional TLUSB109 programming cable).
- Using the quick access  button to select between Mode 1 and Mode 2 or between Mode 1 and Mode 3.

1 – VFO operating mode (frequency on screen)

In this mode the selected frequency is shown on the screen.

Any change on the frequency or any parameter adjustment

(CTCSS, DCS, TOT, Squelch level, etc.) on this mode, will be stored like the last

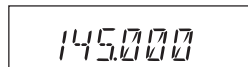

Image 1

permanent value. Once the transceiver is turned off, when you turn it on again the last adjustments will remain active.

Image 1

2 - CHANNEL NUMBER + VFO operating mode (frequency on screen)

In this mode the memory number (channel) and the frequency stored on this channel or memory number is shown on the screen.

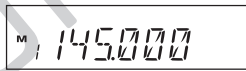

Image 2

Due to the use of an already memorized frequency in this mode, you will be able to make any parameter temporal adjustment (CTCSS, DCS, TOT, squelch level, etc.) on the channel, but all these changes will not be stored. Once you turn off the transceiver and then turn it on again, the last adjustments made before turning off will be lost, and also when you change to any other channel, returning to all the adjustments made at the moment of storing the channel.

NOTE: to use this operating mode you previously need to store on the memory at least the frequency and its parameters configuration if you needed.

3 – CHANNEL NUMBER + CHANNEL NAME operating mode

In this mode the memory number (channel) and the name that you have previously gave to the channel is shown on the screen.

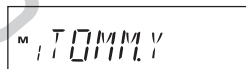



Image 3

As in the previous mode, due to the use of an already memorized frequency in this mode, you will be able to make any parameter temporal adjustment (CTCSS, DCS, TOT, squelch level, etc.) on the channel, but all this changes will be not stored. Once you turn off the transceiver and then turn it on again, the last adjustments made before turning off will be lost, and also when you change to any other channel, returning to all the adjustments made at the moment of storing the channel.

NOTE: to use this operating mode you previously need to store on the memory at least the frequency and its parameters configuration if you needed.

To be able to display the name of the channel you must previously edit it. The operation of editing the channel's name you could make through the transceiver's menu number 11 (see page 63) or through the programming software (requires the optional TLUSB109 programming cable).

The operating **MODE 1 (VFO)** may be alternated with the **MODE 2** or **MODE 3** using the quick access  button. By pressing this button you will switch to **MODE 2** or **MODE 3** depending on the selection made on menu number 26 (see page 76), pressing again the  button you will return again to **MODE 1 (VFO)**.

4 – CHANNEL NAME operating mode

In this mode the name that you have previously edited through the transceiver's menu number 11 (see page 64) or through the programming software (requires the optional TLUSB109 programming cable) is shown on the screen.



Image 4

If you have not previously edited the name of the channel the screen will show, by default, the corresponding memory number as you can see on the image.

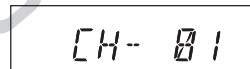

Image 5



NOTE: to use this operating mode you previously need to store on the memory at least the frequency and its parameters configuration if you needed.

In this operating mode and to make it an easier mode, the menus from number 1 to 17 are automatically hidden, consequently it will not be possible to make changes through those menus to change parameters affecting the stored channel, only will be

able to change them through the programming software or returning to any other operating modes. However, the menus from number 18 to 30 will remain enabled and any selection from them will remain, concerning the transceiver in general and some of the buttons to make its use easier, such as the channel searching, squelch level and certain other functions.

Basic functions

Turning on/off the transceiver

Depending on the option chosen during the installation to turn on the station press the  button or turn the vehicle's ignition key to the ON position. To turn off the station press the  button during one second or turn the vehicle's ignition key to the OFF position.

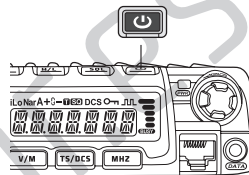

Adjusting the volume

Turn the volume control clockwise to increase the volume, and turn it counter-clockwise to decrease the volume.

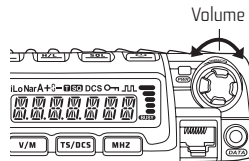

NOTE: during communication, the volume can be set more accurately.

Switching between VFO operating mode and CHANNEL NUMBER + VFO or CHANNEL NUMBER + CHANNEL NAME operating modes

In standby mode, press the **V/M** button either the **VFO MR.** button from the microphone to access to the Channel mode, on the screen the current channel will be shown. Repeat the operation to switch between the VFO and Channel modes.

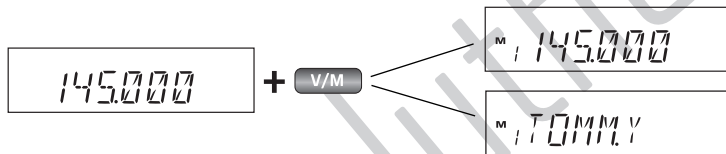

To select between one of the three possible channel modes, see menu number 26 (on page 76).

Adjusting the frequency or the channel

1. In VFO (frequency) mode, you can change the current frequency for the one you desire by turning the “Channel selector”, turning it clockwise you will increase the frequency, turning it counter-clockwise you will decrease the frequency. Every single turn will increase or decrease one point the frequency. Press the **MHZ** button to auto-hide the decimal digits from the selected frequency, that way, by turning the “Channel

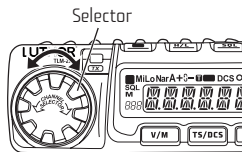

selector” or pressing the [**UP**] / [**DOWN**] buttons from the microphone you will increase or decrease the frequency in 1 MHz steps.

2. In Channel mode, you can change the current channel by turning the “Channel selector”, turning it clockwise you will increase one channel, turning it counter-clockwise you will decrease one channel.

The [**UP**] / [**DOWN**] buttons from the microphone have the same function to adjust both the frequencies and the channels.

NOTE: the frequency steps available are the following ones: 2,5k / 5k / 6,25k / 8,33k / 10k, 12,5k / 20k / 25k / 30k / 50k. (Menu number 1)

Signals reception

When the selected channel is busy, the **BUSY** icon and the signal strength are shown on the screen, this way, you can listen the call from who is transmitting.

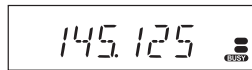

NOTE: if you have selected a high squelch level it is possible to have difficulties to listen the call.

When it is receiving a call on the current channel and the **BUSY** icon and the signal strength are shown on the screen, but you can not listen to the incoming call, may be that you are receiving a matching carrier but with different tones from those which you are using (see the section: Coding and decoding the CTCSS / DCS signals).

Signals transmission

Keep pressing the **TS/DCS** button during one second or press the ***MON BEP** button from the microphone to enable the monitor function and confirm that the channel is not busy. Press again the **TS/DCS** button during one second or press the ***MON BEP** button from the microphone to return to standby mode. And then press the PTT button and talk to the microphone.

Please, keep the microphone at approximately 2,5 – 5 cm from your mouth, and next talk to the microphone with a normal tone of voice.

NOTE: while keeping pressed the PTT button, the red colour of the transmission led indicator and the power strength on the screen will denote that you are transmitting, release the PTT button to receive an answer.

Transmitting tone-pulse (for advanced users)

While keeping pressed the PTT button, press the **DOWN** button from the microphone to transmit the selected tone-pulse signal.

Transmitting optional signals (for advanced users)

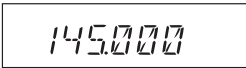

While keeping pressed the PTT button, press the **UP** button from the microphone or press the **Q** button followed by the **H/L** button or the **ONF CALL** button from the microphone to transmit the optional DTMF / 2-Tone / 5-Tone signal previously programmed through the programming software.

Storing a channel/memory

1. In VFO (frequency) mode, turn the main control to select the desired frequency or introduce the frequency using the numeric keypad on the microphone. 
2. If the frequency you want to store uses CTCSS or DCS tones you must select it on this step. (see page 47) section “Coding and decoding the CTCSS / DCS signals”). If, on the other

hand, you do not need to use sub-tones you can skip this section and go straight to step 3.



3. Press the  button, the  icon and the **M** icon and the current channel number are shown on the screen, when the **M** icon flashes means the channel is empty.

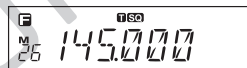

NOTE: before storing a channel make sure it is empty, not doing that you will be able to overwrite the information on a channel already stored and you will lose all the previous information. The best way to verify that a memory is empty is making sure the **M** icon is flashing above the selected channel number on the screen.

4. Turn the “Channel selector” to select the desired memory channel to store.

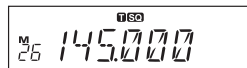

5. Press the  button, the  and **M** icons will disappear from the screen and the station will beep indicating that the channel has been successfully stored.

Deleting a channel

In Channel mode, turn the main control to select the channel you want to delete, press the  button.

Turn the main control to select the memory channel. Press the  button to confirm. Turn the “Channel selector” and the memory number will disappear from the screen.

Quick access to functions through keypad



Setting the squelch level

Function: allows silencing the background noise when no signal is received.

“0” is squelch opened and from 1 to 20 you will obtain the different levels of noise reduction, where “20” is the highest level of reduction. If you set a too high level, the signal that you will receive will be very clean of noise, but it will go to the detriment of the reception distance that will be significantly reduced. On the contrary if you set a too low level, you will count with an increased reception distance but the radio will be object to receive noises or worse quality signals (we recommend you the level “4”).

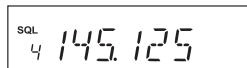
Press the  button and then turn the main control or







press the [] / [] buttons from the microphone to adjust the desired squelch level.

Press any other button except the  button or the  button to exit.

Frequencies searching mode (frequencies scanning – SCAN)

In VFO (frequency) mode, this function is designed to monitor the signals from all those frequencies according to the frequency step previously adjusted.

A rectangular digital display with a black background and white text showing the frequency 145.125.



Keep pressing the  button during 1 second to enable the searching. Once the searching has started, turn the main control or press the [] / [] buttons from the microphone to change the searching direction.

Press any other button except the  button or the  button to exit.

Channels searching mode

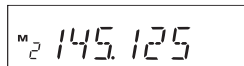
In Channel mode, this function is designed to monitor the signals from all the stored channels.

A rectangular digital display with a black background and white text showing 'M2 145.125'.

Keep pressing the  button during 1 second to enable the searching. Once the searching has started, turn the main control or press the [] / [] buttons from the microphone to change the searching direction.

Press any other button except the  button or the  button to exit.

Setting the analogical CTCSS tones and digital tones on TX and RX (with the station buttons)

In frequency (VFO) mode:

1- Press the **TS/DCS** button: The **T** icon will be shown on the screen, that indicates you have entered into the sub-menu for the analogical CTCSS (go to step 2) or digital DCS (go straight to step 3) sub-tone selection.



2- Press the **TS/DCS** button again, next right to the **T** icon will be shown the **SQ** icon and below the numbering for the 51 CTCSS groups, that indicates you can select the analogical (CTCSS from 62,5 to 254,1) desired sub-tone through the main control. Once selected the CTCSS, press the **MHZ** or **V/M** button to confirm and return to standby mode and be able to transmit or receive with the CTCSS tone activated.

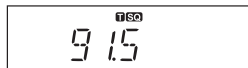

3- Press the **TS/DCS** button again until the **DCS** icon is shown on the screen and below the numbering for the 1024 DCS groups, that indicates you can select the digital (DCS from 000N to 777I)

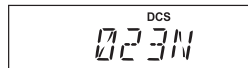

desired sub-tone through the main control. Once selected the DCS, press the **MHZ** or **V/M** button to confirm and return to standby mode and be able to transmit or receive with the DCS tone activated.

NOTE: in any of the Channel modes, this setting will be temporary, once the station will be turned off or you change to another channel, this temporary setting will be lost.

CTCSS signals searching

Press the **TS/DCS** button repeatedly until the **T** and **SQ** icons is shown on the screen, press the **FUNC** button from the microphone and then press the **4 SET SCN** button from the microphone to enter into the CTCSS signals searching mode, once a CTCSS matching signal is found, the searching will stop during 15 seconds and right after will resume the searching.

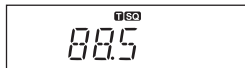

DCS signals searching

Press the **TS/DCS** button repeatedly until the **DCS** icon is shown on the screen, press the **FUNC** button from the microphone and then press the **4 SET SCN** button from the

microphone to enter into the DCS signals searching mode, once a DCS signal is found, the searching will stop during 15 seconds and right after will resume the searching.



Setting the transmission power High / Medium / Low

Press the  button to switch between the High / Medium / Low transmission power. When the **LO** icon is shown on the screen the transmission power is set to low, when the **Mi** icon is shown on the screen the transmission power is set to medium, and if none of those icons is shown on the screen the transmission power is set to high.

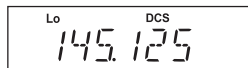
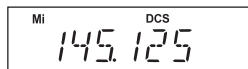
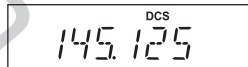

Compander function

This function reduces the background noise and improves the audio quality, particularly during long distance communications.

Press the  button, the  icon will be shown on the

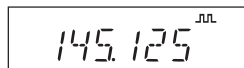

screen, then press the **SOL** button to enable or disable the compander function. The  icon will be shown on the screen when this function is enabled.

145.125

Setting the frequency shift and the shift direction

The repeater receives a signal (UP-LINK) in a frequency and re-transmits in another frequency (DOWN-LINK). The difference between those two frequencies is known as frequency shift. When the UP-LINK frequency is larger than the DOWN-LINK frequency, the direction is positive. When is lesser the direction is negative.

Keep pressing the **H/L** button during 2 seconds to adjust the frequency shift, the frequency shift and the shift direction will be shown on the screen.

Pressing the **H/L** button again the shift direction will change.

When the “**-**” icon is shown on the screen the frequency shift direction is negative.

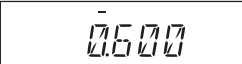
-
0.600

When the “**+**” icon is shown on the screen the frequency shift direction is positive.

+
0.600

Turn the main control or press the [**UP**] / [**DOWN**] buttons from the microphone to select the frequency shift.

Once the selection is done, press the **MHZ** or **V/M** button to confirm and return to standby mode and be able to transmit or receive signals.

Keyboard lock

To prevent from accidentally operating the device, this function lock the keyboard, the only active button is .

Keep pressing the **MHZ** button, the icon  will be shown on the screen indicating that the keyboard is locked.

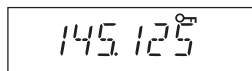





145.125^{MHz}

Repeat the same operation described above to unlock the keyboard, the icon  will disappear from the screen.

Function's detailed descriptions

Menu operation

1. In standby mode, keep pressing the  button during at least 2 seconds to enter into the menu, the selected item will be shown on the screen.
2. Press the  button or the  button to select the desired menu, the current or selected setting is shown on the screen.
3. Turn the main control to select the desired setting.
4. Press the  or  button to confirm, exit and return to standby mode in VFO or Channels.



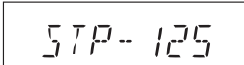

NOTE: in the Channel name mode, the menus from number 1 to 17 are automatically hidden.

01.- Setting the frequency step (STP-125 – MENU 01) (Only adjustable in VFO mode)

Function: setting the frequency steps.



Available values: 2,5k / 5k / 6,25k / 8,33k / 10k, 12,5k / 20k / 25k / 30k / 50k.

1. In VFO mode, keep pressing the  button during at least 2 seconds to enter into the menu.
2. Press the  button or the  button to select the menu number Q1, "STP-125" is shown on the screen.
3. Turn the main control to select the desired frequency step.
4. Press the  or  button to confirm, exit and return to standby mode in VFO or Channels.



NOTE: this parameter will only be able to adjust it in VFO mode, that shows the frequency.

02.- DTMF, ANI, 2-Tone and 5-Tone signals (T-DTMF – MENU Q2) (for advanced users, requires programming software and cable)

The DTMF, ANI, 2-Tone and 5-Tone signals have similarities with CTCSS / DCS signals. Without receiving the corresponding signal's tone, the speaker will remain mute. The DTMF and 5-Tone signals may apply to other advanced functionalities like ANI, PTT ID, group call, etc. The edition of those signals must be done through the programming

software (optional). Please refer to the programming software for adjusting those signals.

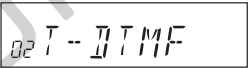

1. In standby mode, keep pressing the  button during at least 2 seconds to enter into the menu.

2. Press the  button or the  button to select the menu number 02, “T-DTMF” is shown on the screen.



02 T -- DTMF

3. Turn the main control to select the desired setting.

“DTMF”: the channel will remain mute due to a DTMF signal. The speaker will not be open until the corresponding DTMF signal will be received. Keep pressing the PTT button, then press the  button from the microphone or press directly the  button to transmit the DTMF signal previously stored through the programming software.

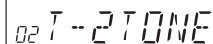

02 T -- 2TONE

“2-Tone”: the channel will remain mute due to a 2-Tone signal. The speaker will not be open until the corresponding 2-Tone signal will be received. Keep pressing the PTT button, then press the  button

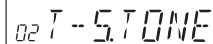

02 T -- 5TONE

from the microphone or press directly the  button to transmit the

2-Tone signal previously stored through the programming software.

“5-Tone”: the channel will remain mute due to a 5-Tone signal. The speaker will not be open until the corresponding 5-Tone signal will be received. Keep pressing the PTT button, then press the **UP** button from the microphone or press directly the **H/L** button to transmit the 5-Tone signal previously stored through the programming software.

“OFF”: no signal selected.

4. Press the **MHZ** button to confirm, exit and return to standby mode.

03.- Sending a 2-Tone signal (2TON-XX – MENU 03) (for advanced users, requires programming software and cable)

1. In standby mode, keep pressing the **P** button during at least 2 seconds to enter into the menu.

2. Press the **H/L** button or the **SQL** button to select the menu number 03, “2TON-XX” is shown on the screen.

3. Turn the main control to select the desired 2-Tone signal group. Press the PTT

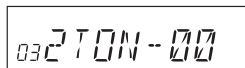

button to transmit the selected group. The total number of groups is 32, from number 00 to 31. The default group is number 00.

4. Press the **MHZ** button to confirm, exit and return to standby mode.

NOTE: the content and the name of the 2-Tone signal groups must be edited through the programming software (optional).

The transceiver can only show the group or its name, in case that a name has been previously edited, the name will be shown.

04.- Sending a 5-Tone signal (STON-XX – MENU 04) (for advanced users, requires programming software and cable)

1. In standby mode, keep pressing the **F** button during at least 2 seconds to enter into the menu.

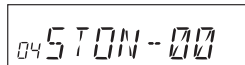
A rectangular LCD display showing the text "04 STON-00" in a digital font. The "04" is on the left, and "STON-00" is on the right.

2. Press the **H/L** button or the **SQL** button to select the menu number 04, "STON-XX" is shown on the screen.

3. Turn the main control to select the desired 5-Tone signal group. Press the PTT button to transmit the selected group. The total number of groups is 100, from

number 00 to 99. The default group is number 00.

4. Press the **MHZ** button to confirm, exit and return to standby mode.

NOTE: the content and the name of the 5-Tone signal groups must be edited through the programming software (optional).

The transceiver can only show the group or its name, in case that a name has been previously edited, the name will be shown.

05.- Sending a DTMF signal (DTMF-XX – MENU 05) (for advanced users, requires programming software and cable)

1. In standby mode, keep pressing the  button during at least 2 seconds to enter into the menu.

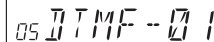

2. Press the **H/L** button or the **SQL** button to select the menu number 05, “DTMF-XX” is shown on the screen.

3. Turn the main control to select the desired DTMF signal group. Press the PTT button to transmit the selected group. The total number of groups is 16, from number 01 to 16. The default group is number 01.

4. Press the **MHZ** button to confirm, exit and return to standby mode.

NOTE: the content and the name of the DTMF signal groups must be edited through the programming software (optional).

06.- Setting the signal combination (SPK-SQ – MENU 06) (for advanced users)

Function: improve the transceiver's protection level against the reception of unwanted signals.

1. In standby mode, keep pressing the **F** during at least 2 seconds to enter into the menu.

2. Press the **H/L** button or the **SQL** button to select the menu number 06, "SPK-SQ" is shown on the screen.

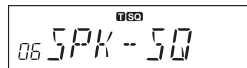

06 SPK-SQ

3. Turn the "Channel selector" control to select the desired combination.

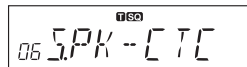

06 SPK-CTC

- If you select "SQ", means that you will be able to listen to any incoming call on the selected channel.
- If you select "CTC", means that you will be able to listen to an incoming call

only when it matches with the CTCSS / DCS selected signal.

- If you select “TON”, means that you will be able to listen to an incoming call only when it matches with the DTMF / 2-Tone / 5-Tone selected signal.



- If you select “C*T”, means that you will be able to listen to an incoming call only when it matches with both the CTCSS / DCS selected signal and with the DTMF / 2-Tone / 5-Tone selected signal.



- If you select “C/T”, means that you will be able to listen to an incoming call only when it matches with the CTCSS / DCS selected signal or with the DTMF / 2-Tone / 5-Tone selected signal.

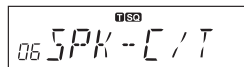

4. Press the **MHZ** or **V/M** button to confirm, exit and return to standby mode.

NOTE: this setting will be fixed when adding the optional signals and the CTCSS / DCS signals.

07.- Setting the High / Medium / Low transmission power (POW-HI – MENU 07)

Function: allows to select the High / Medium / Low transmission power depending on your environment and your needs.

Available values:

HI: high power;

MI: medium power;

LOW: low power.

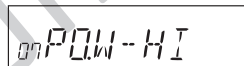



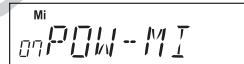

07 POW-HI

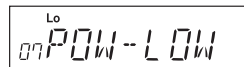

07 POW-MI



07 POW-LOW

1. In standby mode, keep pressing the  button during at least 2 seconds to enter into the menu..
2. Press the  button or the  button to select the menu number 07, “POW-HI” is shown on the screen.
3. Turn the “Channel selector” control to select the desired transmission power.
4. Press the  or  button to confirm, exit and return to standby mode.

08.- Setting the bandwidth (BAND-25 – MENU 08)

Available values:

12: narrow band 12,5KHz

20: medium band 20KHz

25: wide band 25KHz







08 BAND-12



08 BAND-20



08 BAND-25

1. In standby mode, keep pressing the  button during at least 2 seconds to enter into the menu.
2. Press the  button or the  button to select the menu number 08, “BAND-25” is shown on the screen..
3. Turn the “Channel selector” control to select the desired bandwidth.
4. Press the  or  button to confirm, exit and return to standby mode.

09.- Setting reception only (TX-ON – MENU 09)

Function: blocks the possibility of transmitting, this way, only the reception of signals is possible.

1. In standby mode, keep pressing the  button during at

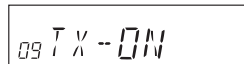

09 TX-ON

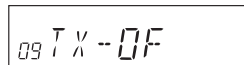

09 TX-OFF

least 2 seconds to enter into the menu.

2. Press the **H/L** button or the **SQL** button to select the menu number 09, "TX-ON" is shown on the screen
3. Turn the "Channel selector" control to select the desired setting.
4. Press the **MHZ** or **V/M** button to confirm, exit and return to standby mode.

10.- Busy channel lock-out (LOCK-OF – MENU 10)

Function: prevent the user from transmitting when the transceiver is receiving a signal. In this way, the equipment will prevent from accidentally disrupting another user that is previously talking. The equipment only will allow to transmit at the time that detects no signal or conversation.

Available values:

"BU": lock activated, if the equipment receive a signal, it will not let us transmit until the end of the reception, when pressing PTT button you will hear an error signal and it will return to reception mode.

"RL": lock activated, if the equipment receive a signal even though the CTCSS/DCS

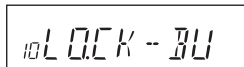



A rectangular LCD display showing the text "10 LOCK - BU" in a monospaced font. The "10" is on the left, "LOCK" is in the middle, and "BU" is on the right, all separated by spaces. The display is enclosed in a thin black border.

signal is not matching, it will not let us transmit until the end of the reception, when pressing PTT button you will hear an error signal and it will return to reception mode.

A rectangular LCD display showing the text "10 LOCK - PL" in a digital font.

“OF”: disable the busy channel lock-out.

A rectangular LCD display showing the text "10 LOCK - OF" in a digital font.

1. In standby mode, keep pressing the  button during at least 2 seconds to enter into the menu.
2. Press the  button or the  button to select the menu number 10, “LOCK-OF” is shown on the screen.
3. Turn the “Channel selector” control to select the desired setting.
4. Press the  or  button to confirm, exit and return to standby mode.

11.- Editing the channel name (_ - MENU 11)

[note: this menu is visible once there is at least one channel stored]

Function: allows to edit the name of the selected channel. (Only editable on the CHANNEL NUMBER + VFO or CHANNEL NUMBER + CHANNEL NAME operating modes).

1. In standby mode, keep pressing the  button during at least 2 seconds to enter

into the menu.

2. Press the **H/L** button or the **SQL** button to select the menu number 11, a blinking cursor “_” is shown on the screen.

3. Turn the “Channel selector” control to select the desired letter. Press the **MHZ** button to confirm the selected letter and edit the next one. Press the **V/M** button to go back on the edition.



11 B _

4. Press the **TS/DCS** button to confirm, exit and return to standby mode

To have the menu number 11 activated, you must be on channel mode and have at least one memory channel stored.

12.- Reverse transmission/reception (REV-OF – MENU 12)

Function: when enabling the reverse function it makes that the emission frequency becomes the reception frequency and the reception frequency becomes the emission frequency, in the cases where both are different. The signal will also reverse in cases where the selected channel has CTCSS/DCS signals edited.

ON: enable the reverse frequency.

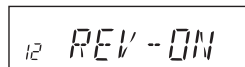

12 REV - ON

OF: disable the reverse frequency.

A rectangular LCD display showing the number '12' on the left and the text 'REV-OF' on the right.

1. In standby mode, keep pressing the button during at least 2 seconds to enter into the menu.
2. Press the button or the button to select the menu number 12, “REV-OF” is shown on the screen.
3. Turn the “Channel selector” control to select the desired setting.
4. Press the or button to confirm, exit and return to standby mode.

13.- Talk around (TALK-OF – MENU 13)

Función: allows for direct communication with another stations in cases where the repeater is not active or when the transceiver is out of the repeater’s operating range.

The transceiver will transmit through the reception frequency with its CTCSS/DCS signal.

A rectangular LCD display showing the number '13' on the left and the text 'TALK-ON' on the right.

ON: enable the Talk around function.

OF: disable the Talk around function.

A rectangular LCD display showing the number '13' on the left and the text 'TALK-OF' on the right.

1. In standby mode, keep pressing the button during at least 2 seconds to enter

into the menu.

2. Press the **H/L** button or the **SQL** button to select the menu number 13, “TALK-OF” is shown on the screen.
3. Turn the “Channel selector” control to select the desired setting.
4. Press the **MHZ** or **V/M** Turn the “Channel selector” control to select the desired setting.

14.- Compander function (COMP-OF – MENU 14)

Function: this function reduces the background noise and improves the audio quality, particularly during long distance communications.

ON: enable the Compander function.

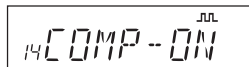

14 COMP-ON

OF: disable the Compander function.

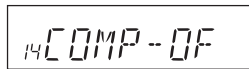

14 COMP-OF

1. In standby mode, keep pressing the  button during at least 2 seconds to enter into the menu.
2. Press the **H/L** button or the **SQL** button to select the menu number 14, “COMP-OF” is shown on the screen

3. Turn the “Channel selector” control to select the desired setting.
4. Press the **MHZ** or **V/M** button to confirm, exit and return to standby mode.

15.- Encryption function (SCR-OF – MENU 15)

Function: use this function when you want to obtain the maximum privacy in your conversations, it makes almost impossible to listen to the conversation for a non desired user. This function distorts your voice and only can be understood for another user having the same transceiver with the same encryption, otherwise, the conversation will be understandable.

ON: enable the Encryption function.

OF: disable the Encryption function.

1. In standby mode, keep pressing the **F** button during at least 2 seconds to enter into the menu.
2. Press the **H/L** button or the **SQL** button to select the menu number 15, “SCR-OF” is shown on the screen.
3. Turn the “Channel selector” control to select the desired setting: OFF (1 to 8) UDF.

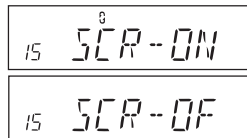

4. Press the **MHZ** or **V/M** button to confirm, exit and return to standby mode.

16.- Displaying the DTMF identifier (D-XXX – MENU 16) (for advanced users)

Function: displaying the DTMF identifier from the transceiver.

1. In standby mode, keep pressing the **F** button during at least 2 seconds to enter into the menu.

2. Press the **H/L** button or the **SQL** button to select the menu number 16, “D-XXX” is shown on the screen.

3. The XXX digits are the DTMF identifier from the transceiver.



4. Press the **MHZ** or **V/M** button to confirm, exit and return to standby mode.

17.- Displaying the 5-Tone identifier (F-XXXXX – MENU 17) (for advanced users)

Function: displaying the 5-Tone identifier from the transceiver.

1. In standby mode, keep pressing the **F** button during at least 2 seconds to enter into the menu.

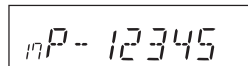

2. Press the **H/L** button or the **SQL** button to select the menu number 17, “F-XXXXX” is shown on the screen.
3. The XXXXX digits are the 5-Tone identifier from the transceiver.
4. Press the **MHZ** or **V/M** button to confirm, exit and return to standby mode.

18.- Key operation confirmation sound (BEEP-ON – MENU 18)

Function: enable/disable the key operation confirmation sound.

ON: enable the BEEP function.

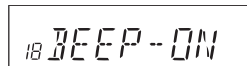
A rectangular LCD display showing the text "18 BEEP-ON" in a digital font. The number "18" is on the left, and "BEEP-ON" is on the right.



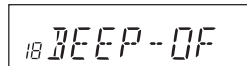

OF: disable the BEEP function.

A rectangular LCD display showing the text "18 BEEP-OF" in a digital font. The number "18" is on the left, and "BEEP-OF" is on the right.

1. In standby mode, keep pressing the **PA** button during at least 2 seconds to enter into the menu.
2. Press the **H/L** button or the **SQL** button to select the menu number 18, “BEEP-ON” is shown on the screen..
3. Turn the “Channel selector” control to select the desired setting.
4. Press the **MHZ** or **V/M** button to confirm, exit and return to standby mode.

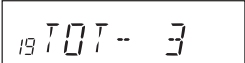
19.- Time Out Timer (TOT) (TOT-3 – MENU 19)

Function: allows limiting the maximum time for a transmission. Strongly recommended when working in groups, in this way you will be able to limit the maximum time of conversation for every person in the group and avoid a transmission monopolising by an only user. Allows to select the maximum time for a transmission from 1 to 30 minutes







1. In standby mode, keep pressing the  button during at least 2 seconds to enter into the menu. 
2. Press the  button or the  button to select the menu number 19, “TOT-3” is shown on the screen..
3. Turn the “Channel selector” control to select the desired setting.
4. Press the  or  button to confirm, exit and return to standby mode.

20.- Auto Power OFF (APO-OFF – MENU 20)

Function: prevents that the transceiver remain accidentally powered on, the transceiver will automatically power off once the pre-defined time has passed

without carrying any action.

Available values: 30 minutes / 60 minutes / 120 minutes / OFF.

1. In standby mode, keep pressing the  button during at least 2 seconds to enter into the menu 
2. Press the  button or the  button to select the menu number 20, “APO-OFF” is shown on the screen. 
3. Turn the “Channel selector” control to select the desired setting.
4. Press the  or  button to confirm, exit and return to standby mode.

21.- Transmission time for DTMF signals (SPD-50 – MENU 21) (for advanced users)

Function: adjusting the transmission time (in milliseconds) for DTMF signals and the interval between each one of the DTMF signals sent.

Available values: 30ms / 50ms / 100ms / 200ms / 300ms / 500ms.

1. In standby mode, keep pressing the  button during at least 2 seconds to enter into the menu.
2. Press the  button or the  button to select the menu number 21, “SPD-

50" is shown on the screen



3. Turn the "Channel selector" control to select the desired setting.

4. Press the  or  button to confirm, exit and return to standby mode.

22.- Setting the squelch level (SQL-04 – MENU 22) (for advanced users)

Function: allows silencing the background noise when no signal is received. "0" is squelch opened and from 1 to 20 you will obtain the different levels of noise reduction, where "20" is the highest level of reduction. If you set a too high level, the signal that you will receive will be very clean of noise, but it will go to the detriment of the reception distance that will be significantly reduced. On the contrary if you set a too low level, you will count with an increased reception distance but the radio will be object to receive noises or worse quality signals (we recommend you the level "4").

1. In standby mode, keep pressing the  button during at least 2 seconds to enter into the menu.

2. Press the **H/L** button or the **SQL** button to select the menu number 22, “SQL-04” is shown on the screen.
3. Turn the “Channel selector” control to select the desired squelch level.
4. Press the **MHZ** or **V/M** button to confirm, exit and return to standby mode.



22 SQL-04

23.- Setting the search mode (SCAN-TO - MENU 23)

There are three search options:

TO: in this mode, the search will stop in the signal found, and will stay in this signal for about 15 seconds. If you don't make any action to cancel the search during this period of time, the search will resume although the signal is still active.

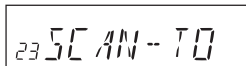

23 SCAN-TO

CO: in this mode, the search will stop in the signal found, and will stay in this signal until it ends. Once the signal ends, the search will resume.

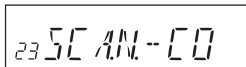



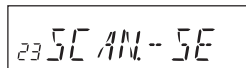

23 SCAN-CO

SE: in this mode, the search will stop in the signal found, and the search will not resume automatically, you must





23 SCAN-SE

resume the search if you want it to continue

1. In standby mode, keep pressing the  button during at least 2 seconds to enter into the menu.
2. Press the  button or the  button to select the menu number 23, “SCAN-TO” is shown on the screen.
3. Turn the “Channel selector” control to select the desired search mode.
4. Press the  or  button to confirm, exit and return to standby mode.

24.- Setting the display contrast (LAMP-1 – MENU 24)

Function: adjusting the contrast level of the display. From 1 to 32, this setting makes the display illuminating with a greater or lesser light intensity.

1. In standby mode, keep pressing the  button during at least 2 seconds to enter into the menu.
2. Press the  button or the  button to select the menu number 24, “LAMP-1” is shown on the screen.

3. Turn the “Channel selector” control to select the desired contrast level.
4. Press the **MHZ** or **V/M** button to confirm, exit and return to standby mode.

25.- Setting the display colour (COLOR-1 – MENU 25)

Function: allows selecting the display colour between blue, red and violet.

COLOR1: blue.

COLOR2: red.

COLOR3: violet.

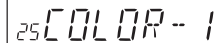
A rectangular LCD display showing the text "25 COLOR-1" in a digital font.

1. In standby mode, keep pressing the **F** button during at least 2 seconds to enter into the menu.
2. Press the **H/L** button or the **SQL** button to select the menu number 25, “COLOR-1” is shown on the screen.
3. Turn the “Channel selector” control to select the desired display colour.
4. Press the **MHZ** or **V/M** button to confirm, exit and return to standby mode.

26.- Setting the operating mode (DSP-FR – MENU 26)

Function: selecting the operating mode between the three available on mode Channel.

NOTE: see page 32 for a complete explanation of the different operating modes of the transceiver between which you will be able to select it on this menu.

FR: CHANNEL NUMBER + VFO mode

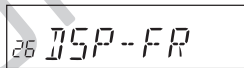

26 DSP-FR

CH: CHANNEL NUMBER mode

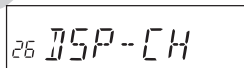



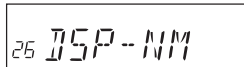

26 DSP-CH

NM: CHANNEL NUMBER + CHANNEL NAME mode



26 DSP-NM





1. In standby mode, keep pressing the  button during at least 2 seconds to enter into the menu.
2. Press the  button of the  button to select the menu number 26, “DSP-FR” is shown on the screen.
3. Turn the “Channel selector” control to select the desired operating mode.
4. Press the  or  button to confirm, exit and return to standby mode.

27.- Repeater tone calling (TB-1750 – MENU 27)

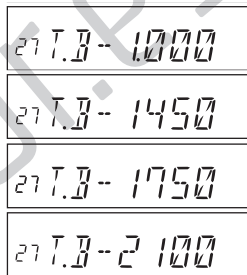
Function: some repeaters require a tone calling preceding the communication. The repeater only will be able to open to give way to the communication's signal before one particular tone that will act as a sort of key. Once the repeater is open and while the transmission lasts it will not be necessary to send the tone again.

Available values: 1000Hz / 1450Hz / 1750Hz / 2100Hz.



1. In standby mode, keep pressing the  button during at least 2 seconds to enter into the menu.
2. Press the  button or the  button to select the menu number 27, "TB-1750" is shown on the screen.
3. Turn the "Channel selector" control to select the desired setting.
4. Press the  or  button to confirm, exit and return to standby mode.





28.- Login password (CODE-OF – MENU 28)

Function: set up a login password based on a PIN code to power on the transceiver. (The changing of the PIN code is made through the programming software and optional programming cable).

A rectangular LCD display showing the text '28 CODE-OF'. The number '28' is on the left, and 'CODE-OF' is on the right, both in a digital font.

ON: enable the login password.





OF: disable the login password.

1. In standby mode, keep pressing the  button during at least 2 seconds to enter into the menu.
2. Press the  button or the  button to select the menu number 28, “CODE-OF” is shown on the screen.
3. Turn the “Channel selector” control to select the desired setting.
4. Press the  or  button to confirm, exit and return to standby mode.

29.- Address book (BOOK – MENU 29) (for advanced users)

Function: to memorise an identifier (ID) and its corresponding name on the address book. When the transceiver receives an ANI code and find its ID on the address book,

displays on the screen the corresponding name for this ID.

1. In standby mode, keep pressing the  button during at least 2 seconds to enter into the menu.
2. Press the  button or the  button to select the menu number 29, “BOOK” is shown on the screen.
3. Turn the “Channel selector” control to select the desired group between 0 and 127.
4. Press the  or  button to confirm, exit and return to standby mode.



29 BOOK



127 ID135--

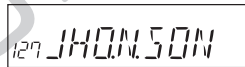

127 JHONSON

30.- Restoring initial settings (RESTORE – MENU 30)

Function: in cases where your transceiver seems to be malfunctioning, restoring the microprocessor may solve the problem. Back up important data you want to keep before performing the reset.

FACT: restore the factory defaults.

SETUP: restore the factory defaults for the menus from 18 to 28.

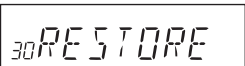



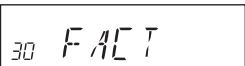

30 RESTORE

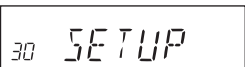

30 FACT



30 SETUP

1. In standby mode, keep pressing the  button during at least 2 seconds to enter into the menu.
2. Press the  button or the  button to select the menu number 30, "RESTORE" is shown on the screen.
3. Turn the "Channel selector" control to select the desired setting FACT/SETUP.
4. Press the  button to confirm, exit and return to standby mode.

Microphone functions

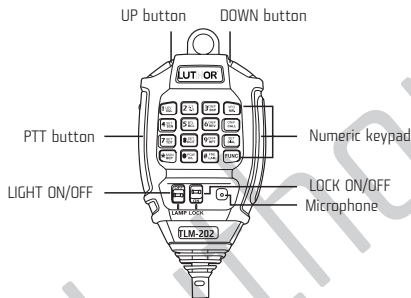

You can operate the transceiver from the numeric keypad or introduce the frequency or channel desired through the microphone.

NOTE: in the CHANNEL NAME operating mode, all the buttons will remain inactive except

PTT, [**UP**] / [**DOWN**], and .



Keypad lock

Slide up the lock switch to the “ON” position, the keypad light turns off and all the buttons are inactive except PTT button.

Transmitting DTMF signals through the microphone (for advanced users)

Slide down the DTMF switch, keep pressing the PTT button, transmit the desired DTMF signal directly from the numeric keypad. (Note: sliding up the DTMF switch in standby mode disables the keypad).

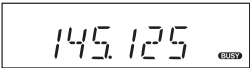
Monitor function

In standby mode, press the  button to activate the monitor function, when the **BUSY** icon blinks on the screen  means the squelch is disabled. Press again the  button to enable again the squelch and the **BUSY** icon will disappear from the screen.

Switching between VFO and CHANNEL modes

In standby mode, press the  button to switch between the CHANNEL (except CHANNEL NAME mode) and VFO operating modes. (For more information see the page xxxx: Transceiver's operating modes).

Transmitting optional signals (for advanced users)

In standby mode, press the **ONIF CALL** button to transmit the DTMF / 2-Tone / 5-Tone optional signal previously stored on the current channel.

Transmitting a DTMF code: in standby mode, press the **SET DIAL** button, the DTMF signal and the group will be shown on the screen. Press the [**UP**] / [**DOWN**] buttons to select the desired DTMF group, then press the PTT button to transmit. In the event that there is no DTMF signal on the selected group, "EMPTY" will be shown on the screen, press again the **SET DIAL** button and introduce the desired DTMF code through the numeric keypad, press the PTT button to transmit and store the DTMF data.

Setting the squelch level

In standby mode, press the **FUNC** button, then press the **1 LEV SQL** button, "SQUELCH" and the current squelch level are shown on the screen. Press the [**UP**] / [**DOWN**] buttons to adjust the desired squelch level. Press the **1 LEV SQL** button to confirm and exit.

Transmitting optional signals (for advanced users)

In standby mode, press the **FUNC** button, then press the **2nd SET** button to add an optional signal, repeat the same operation to adjust a DTMF, 2-Tone or 5-Tone signal. When the first digit of the hexadecimal code shown on the screen begins with a “D” means that the DTMF signal is active.

When the first digit of the hexadecimal code shown on the screen begins with a “T” means that the 2-Tone signal is active.

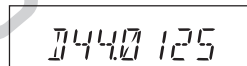
A rectangular LCD display showing the hexadecimal code "D440 125" in a digital font.A rectangular LCD display showing the hexadecimal code "T440 125" in a digital font.

When the first digit of the hexadecimal code shown on the screen begins with a “F” means that the 5-Tone signal is active.

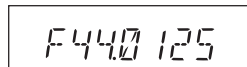
A rectangular LCD display showing the hexadecimal code "F440 125" in a digital font.

This function can be used temporarily in the CHANNEL mode. Once the radio will be turned off or changed to another channel, this temporary setting will be lost returning to the initial setting.

Search skip

In standby mode, press the **FUNC** button, then press the **3^{DNF}SKP** button, the decimal point that is between the tens and the units of the frequency, means that the current channel will be skipped during the search. If this decimal point is not showed, means that the current channel will be not skipped during the search.

Frequencies/Channels search modes (in all operating modes)

In the corresponding mode, press the **FUNC** button, then press the **4^{SET}SCN** button to activate the search. Once the searching has started, press the [**UP**] / [**DOWN**] buttons to change the searching direction.

Busy channel lock-out

Prevent the user from transmitting when the transceiver is receiving a signal. In this way, the equipment will prevent from accidentally disrupting another user that is previously talking. The equipment only will allow to transmit at the time that detects no signal or conversation.

In standby mode, press the **FUNC** button, then press the **5^{RTL}_{BCL}** button, with the main control “Channel selector” select the desired setting.

“**BU**”: lock activated, if the equipment receive a signal, it will not let us transmit until the end of the reception, when pressing PTT button you will hear an error signal and it will return to reception mode.

“**RL**”: lock activated, if the equipment receive a signal even though the CTCSS/DCS signal is not matching, it will not let us transmit until the end of the reception, when pressing PTT button you will hear an error signal and it will return to reception mode.

“**OFF**”: disable the busy channel lock-out.

Press a numeric key to confirm, exit and return to standby mode.

Reverse transmission/reception

When enabling the reverse function it makes that the emission frequency becomes the reception frequency and the reception frequency becomes the emission frequency, in the cases where both are different. The signal will also reverse in cases where the selected channel has CTCSS/DCS signals edited.

In standby mode, press the **FUNC** button, then press the **6 ONF REV** button, with the main control “Channel selector” select the desired setting.

ON: enable the reverse frequency.

OF: disable the reverse frequency.

Press a numeric key to confirm, exit and return to standby mode.

Time Out Timer (TOT)

Allows limiting the maximum time for a transmission. Strongly recommended when working in groups, in this way you will be able to limit the maximum time of conversation for every person in the group and avoid a transmission monopolising by an only user.

In standby mode, press the **FUNC** button, then press the **7 SET TOT** button, with the main control “Channel selector” select the desired setting: allows to select the maximum time for a transmission from 1 to 30 minutes (in one minute increments).

OFF: disable the time out timer function.

Press a numeric key to confirm, exit and return to standby mode.

Setting the analogical CTCSS tones and digital tones on TX and RX (with the station buttons)

In frequency (VFO) mode:

1. Press the **FUNC** button and then press the **8 SET DCT** button: the **T** icon will be shown on the screen, that indicates you have entered into the sub-menu for the analogical CTCSS (go to step 2) or digital DCS (go straight to step 3) sub-tone selection.

2. Press the **FUNC** button again and then press the **8 SET DCT** button, next right to the **T** icon will be shown the **SQ** icon and below the numbering for the 51 CTCSS groups, that indicates you can select the analogical (CTCSS from 62,5 to 254,1) desired sub-tone through the [**UP**] / [**DOWN**] buttons. Once selected the CTCSS, press the **VFO MR.** or **ONF CALL** button to confirm and return to VFO mode and be able to transmit or receive with the CTCSS tone activated.

3. Press the **FUNC** button again and then press the **8 SET DCT** button until the **DCS** icon is shown on the screen and below the numbering for the 1024 DCS groups, that indicates you can select the digital (DCS from 000N to 777I) desired sub-tone through the [**UP**] / [**DOWN**] buttons. Once selected the DCS, press the **VFO MR.** or **ONF CALL** button to confirm and return to VFO mode and be able to transmit or receive with the DCS tone activated.

button to confirm and return to VFO mode and be able to transmit or receive with the DCS tone activated.

Talk around

This function allows for direct communication with another stations in cases where the repeater is not active or when the transceiver is out of the repeater's operating range. The transceiver will transmit through the reception frequency with its CTCSS/DCS signal.

In standby mode, press the **FUNC** button, then press the **9^{ONF}RPT** button, with the main control "Channel selector" select the desired setting.

ON: enable the Talk around function.

OF: disable the Talk around function.

Press a numeric key to confirm, exit and return to standby mode.

Key operation confirmation sound (BEEP)

This function allows to enable/disable the key operation confirmation sound.

In standby mode, press the **FUNC** button, then press the ***MCH BEEP** button, with the main control “Channel selector” select the desired setting.

ON: enable the BEEP function.

OF: disable the BEEP function.

Press a numeric key to confirm, exit and return to standby mode.

Setting the High / Medium / Low transmission power

This function allows to select the High / Medium / Low transmission power depending on your environment and your needs.

In standby mode, press the **FUNC** button, then press the **0 POW HIL** button, with the main control “Channel selector” select the desired setting.

HI: high power.



MI: medium power.

LOW: low power.

Press a numeric key to confirm, exit and return to standby mode.

Cloning cable

Using this function you will be able to copy the programmed memory settings and the parameters from one main station (master) to another station (slave).

1. Use the cloning cable (optional), connect the cable to the front data connector of both stations.
2. Press the  button on both stations, the  icon will be shown on the screen, then press the  button to enter into the cloning mode, “CLONE” will be shown on the screen.

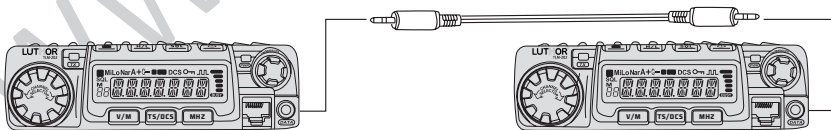
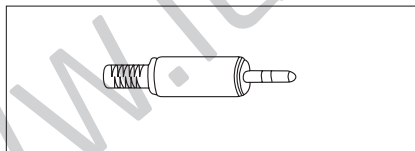

3. Press the PTT button from the main station (master), “SD XXX” will be shown on the screen, where XXX will indicate the data percentage of transferred data. “LD XXX” will be shown on the screen of the slave station, where XXX will indicate the data percentage of received data. When the transmission has been correctly completed, “PASS” will be shown on the screen of both stations. Turn off both stations, disconnect the cloning cable and in case you want to clone another station, repeat the steps 2 and 3.

NOTE: if the data is not correctly transferred, turn off both stations, make sure that the cloning cable is correctly connected and repeat all the operation from the beginning.

*WARNING: if you press the “Clone” option without having the stations ready for cloning, the transceiver will remain blocked and you should power off and then power on through the  button, that will remain as the only operating button.

Troubleshooting guide

Problema	Posible causa	Posible solución
The screen do not show anything	The positive and negative polarities are changed (Risk of breakdown)	Connect the red cable to the positive (+) terminal, and the black cable to the negative (-) terminal from the power supply.
The fuse has blown		Replace it with a new one.
The screen is hardly seen	The screen brightness level has been set too low	Set it with a higher value.
There's no sound from the speaker	<ol style="list-style-type: none"> 1. The squelch is set with a too high level. 2. The radio has enabled some CTCSS/DCS tone. 	<ol style="list-style-type: none"> 1. Set the squelch to a lower appropriate level. 2. Disable the CTCSS/DCS tones.
The buttons and the main control do not work	The keyboard lock function is enabled.	Disable this function.
The main control does not change the channels.	The transceiver has the CALL mode enabled.	Change to the VFO mode.

Can not transmit when pressing the PTT button	<ol style="list-style-type: none">1. The microphone is not properly connected.2. The antenna is not properly connected.	<ol style="list-style-type: none">1. Connect it again.2. Connect it again.
---	--	---

Technical specifications

General

Frequency Range	VHF 144 ~ 146 MHz
Memory channels	200
Bandwidth	25K (broad); 20K (median); 12,5K (narrow)
Frequency steps	2,5 KHz / 5KHz / 6,25KHz / 8,33KHz / 10KHz / 12,5KHz / 20KHz / 25KHz / 30KHz / 50KHz
Operating voltage	DC 13,8V ± 15%
Frequency stability	± 2.5 ppm
Dimensions	145mm An. x 47mm Alt. x 190mm Prof.
Weight	1,2kg aprox.

Transmitter	Wide band	Narrow band
Power output	60W/25W/10W	45W/25W/10W
Modulation mode	16 k Ć F3E	11 k Ć F3E
Adjacent channel power	≥ 70 dB	≥ 60 dB

Noise	≥ 40 dB	≥ 36 dB
Spurious radiation	≥ 60 dB	≥ 60 dB
Audio response	+1 ~ -3dB (0,3 ~ 3KHz)	+1 ~ -3dB (0,3 ~ 2,55KHz)
Audio distortion	≤ 5 %	

Receiver	Wide band	Narrow band
Sensitivity (12 dB Sinad)	$\leq 0,25$ mV	$\leq 0,35$ mV
Selectivity	≥ 70 dB	≥ 60 dB
Intermediation	≥ 65 dB	≥ 60 dB
Spurious reject	≥ 70 dB	≥ 70 dB
Audio response	+1 ~ -3dB (0,3 ~ 3KHz)	+1 ~ -3dB (0,3 ~ 2,55KHz)
Noise	≥ 45 dB	≥ 40 dB
Audio distortion	≤ 5 %	
Audio power output	> 2 W @ 10%	

ATTENTION: Some of these specifications can be subject to modification without previous notice..

Table of analogical CTCSS tones

62.5	67.0	79.7	94.8	110.9	131.8	156.7	171.3	186.2	203.5
229.1	69.3	82.5	97.4	114.8	136.5	159.8	173.8	189.9	206.5
233.6	71.9	85.4	100.0	118.8	141.3	162.2	177.3	192.8	210.7
241.8	74.4	88.5	103.5	123.0	146.2	165.5	179.9	196.6	218.1
250.3	77.0	91.5	107.2	127.3	151.4	164.9	167.9	183.5	199.5
225.7	254.1								

NOTE: N is the positive code, I is the inverse code, a total of 232.

Table of digital DCS tones

000	001	002	003	004	005	006	007
010	011	012	013	014	015	016	017
020	021	022	023	024	025	026	027
030	031	032	033	034	035	036	037
040	041	042	043	044	045	046	047
050	051	052	053	054	055	056	057
060	061	062	063	064	065	066	067
070	071	072	073	074	075	076	077
080	081	082	083	084	085	086	087
090	091	092	093	094	095	096	097
100	101	102	103	104	105	106	107
110	111	112	113	114	115	116	117
120	121	122	123	124	125	126	127
130	131	132	133	134	135	136	137
140	141	142	143	144	145	146	147
150	151	152	153	154	155	156	157
160	161	162	163	164	165	166	167
170	171	172	173	174	175	176	177

180	181	182	183	184	185	186	187
190	191	192	193	194	195	196	197
200	201	202	203	204	205	206	207
210	211	212	213	214	215	216	217
220	221	222	223	224	225	226	227
230	231	232	233	234	235	236	237
240	241	242	243	244	245	246	247
250	251	252	253	254	255	256	257
260	261	262	263	264	265	266	267
270	271	272	273	274	275	276	277
280	281	282	283	284	285	286	287
290	291	292	293	294	295	296	297
300	301	302	303	304	305	306	307
310	311	312	313	314	315	316	317
320	321	322	323	324	325	326	327
330	331	332	333	334	335	336	337
340	341	342	343	344	345	346	347
350	351	352	353	354	355	356	357
360	361	362	363	364	365	366	367
370	371	372	373	374	375	376	377
380	381	382	383	384	385	386	387

390	391	392	393	394	395	396	397
400	401	402	403	404	405	406	407
410	411	412	413	414	415	416	417
420	421	422	423	424	425	426	427
430	431	432	433	434	435	436	437
440	441	442	443	444	445	446	447
450	451	452	453	454	455	456	457
460	461	462	463	464	465	466	467
470	471	472	473	474	475	476	477
480	481	482	483	484	485	486	487
490	491	492	493	494	495	496	497
500	501	502	503	504	505	506	507
510	511	512	513	514	515	516	517
520	521	522	523	524	525	526	527
530	531	532	533	534	535	536	537
540	541	542	543	544	545	546	547
550	551	552	553	554	555	556	557
560	561	562	563	564	565	566	567
570	571	572	573	574	575	576	577
580	581	582	583	584	585	586	587
590	591	592	593	594	595	596	597

600	601	602	603	604	605	606	607
610	611	612	613	614	615	616	617
620	621	622	623	624	625	626	627
630	631	632	633	634	635	636	637
640	641	642	643	644	645	646	647
650	651	652	653	654	655	656	657
660	661	662	663	664	665	666	667
670	671	672	673	674	675	676	677
680	681	682	683	684	685	686	687
690	691	692	693	694	695	696	697
700	701	702	703	704	705	706	707
710	711	712	713	714	715	716	717
720	721	722	723	724	725	726	727
730	731	732	733	734	735	736	737
740	741	742	743	744	745	746	747
750	751	752	753	754	755	756	757
760	761	762	763	764	765	766	767
770	771	772	773	774	775	776	777

Environment protection note

We have done everything possible to obtain the maximum of detail in this manual, but we are not responsible for any possible omission as well as printing errors or translation. All the specifications are subject to change without previous notice.

Note on environmental protection:

This symbol on the product or its packaging indicates that at the end of the useful life of this product the user is legally obligated to fulfil the European directive 2002/96/EU in the legislative national system (RD 208/2005), which applies the following: the electrical and electronic equipment, as well as batteries and rechargeable batteries, can not be treated as normal household waste, but must be delivered to the corresponding collection point. By ensuring that this product is rejected correctly, you help with this action to prevent negative consequences for the environment and human health which could be caused by its inappropriate management. The recycling of materials helps to preserve natural resources. To receive detailed information about the recycling of this product, please contact the city office, the most nearby waste disposal service or the establishment where you purchased the product.



Declaration of conformity

CE 0700 

EN

The undersigned, in representation of:

Company: LOCURA DIGITAL S.L.
Address: Av. Sant Julià, 154, Nave 2
08403 Granollers – Barcelona (Spain)
Telephone number: 93 861 63 72
Fax number: 93 846 89 87
VAT number: B97151369
e-mail address: gestion@locuradigital.com

We declare under our sole responsibility the conformity of the following product:

Type of equipment: VHF FM Mobile transceiver for amateur
Brand name: LUTHOR TECHNOLOGIES
Model number: TLM-202
Manufacturer: LOCURA DIGITAL S.L.
Manufacturing site: China

Which it refers this declaration, with the following rules or other policy documents:

- EN 60950-1 Safety regarding information technology equipments. General requirements.
- EN 301 489-1 V1.9.2:2011
- EN 301 489-5 V1.3.1:2002 Electromagnetic compatibility and Radio spectrum Matters (ERM); ElectroMagnetic Compatibility (EMC) standard for radio equipment and services; Part 1: Common technical requirements; Part 5: Specific conditions for Private land Mobile Radio (PMR) and ancillary equipment (speech and non-speech)
- EN 300 086-1 V 1.4.1
- EN 300 086-2 V 1.3.1 Electromagnetic compatibility and Radio spectrum Matters (ERM); Land Mobile Service; Technical features and testing conditions for Radio equipment with an internal or external RF connector intended primarily for analogue speech; Part 2: Harmonized EN covering the essential requirements of article 3.2 of the R&TTE Directive
- Directive RoHS 2011/65/UE About restrictions of the use of certain hazardous substances in electrical and electronic equipment (EEE).

In accordance with the requirements of Directive 99/05/EC, of the European Parliament and the 9th March 1999 Council, transposed into Spanish law by Royal Decree 1890/2000 of 20th November 2000.

Granollers 29 de Febrero de 2012



Josefa Paredes Martinez
Manager

Locura Digital S.L.
Av. Sant Julià, 154, Nave 2
08403 Granollers – Barcelona (Spain)
Telephone number: 93 861 63 72 / Fax number: 93 846 89 87
C.I.F.: B-97151369

“LIFE IS GOOD
COMMUNICATION”

luthortechnologies.com

Importador/Imported by
Importé par
Genereus S.L.
ESB66339029