

TLM-808

LUTHOR
TECHNOLOGIES

USER'S MANUAL

DUAL BAND MOBILE TRANSCEIVER

VHF / UHF

CE 0700!



We want to appreciate the confidence shown by purchasing this dual band transceiver **LUTHOR TECHNOLOGIES model TLM-808**. This transceiver offers an innovative design in terms of technology and multi-functionality. Its high quality and extensive features make it one of the best equipments in its field, we trust in your total satisfaction with your expectations and communication needs.

Please read carefully the following manual before using the transceiver in order to guarantee the equipment's maximum performances.

The use of the symbol  shows that this equipment is under use restrictions in certain countries.

Countries where the use of this equipment is permitted, without prejudice that in any of them their administration request a licence, an authorisation or indicates some restrictions. In case of doubt we recommend you to request the competent authority of the country where you intend to use this equipment.

AT	BE	DK	FI	FR	DE	GR	IS	LT	MT	PL
IE	IT	LI	LU	NL	NO	PT	ES*	SK	SI	
SE	CH	GB	CY	CZ	EE	HU	LV	BG	RO	

*ES: for using this transceiver, the user must have a personal amateur radio licence.

The use of amateur radio transceivers is allowed within the frequencies assigned for an amateur use: that is 144-146 MHz on VHF, 430-440 MHz on UHF and both on dual band transceivers.

Cautions and practical advices

- Do not use the transceiver if you are driving a vehicle. To prevent accidents, focus only on driving.
- This transceiver is designed for a power supply maximum voltage of 13,8 volts. Do not use a battery with 24 volts to supply power to the transceiver.
- Do not place the transceiver on excessively dusty or wet areas, nor on unstable surfaces.
- Please, keep it away from interfering devices such as televisions, generators, etc.
- Avoid exposing the transceiver to the sun for long periods of time, or installing it nearby heating devices.
- If the transceiver emanates an strange smell or smoke, turn off the device immediately. Get in contact with your dealer.
- Avoid to transmit for long periods of time with the maximum power, the transceiver should overheat.

Contents index

Included in the package	9
Main features	10
Installation	11
Mobile transceiver installation	11
Mounting bracket installation	12
Controller cable connection	12
DC Power cable connection	14
Base station installation	16
Fuse replacement	18
Antenna connection	19
Accessories connection	20
Microphone	22
Transceiver's description	23
Front panel	23
Introduction to display's icons	28
Back view	30
Microphone	30

Basic functions	32
Power on / off the transceiver.....	32
Setting the volume	32
Setting the squelch level.....	32
Selecting the operating band.....	33
Selecting the frequencies band	34
Setting a frequency.....	34
Receiving a call.....	35
Transmitting a call.....	35
Setting the transmission power level	36
Memory functions	37
Storing memory channels.....	37
Separate Transmit Frequency Memory (“Odd Splits”).....	39
Memory recall.....	39
Memory tuning.....	40
Deleting a memory.....	40
HOME memory channel.....	41
Hyper memory channel.....	42

Memory only mode.....	43
Advanced functions.....	44
Repeater operation.....	44
CTCSS tones / DCS codes operation.....	46
DCS codes inversion.....	49
CTCSS / DCS search scanning.....	50
User-defined CTCSS tones / DCS codes.....	51
Searching.....	53
Time.....	53
Busy.....	53
VFO search.....	54
Memories search.....	54
Memory skip search.....	55
Preferential memory search.....	56
Exploring programmed memories.....	57
Priority channel searching (Dual Watch).....	58
VFO priority.....	58
Memory priority.....	59

DTMF operation.....	60
2-tones and 5-tones signals operation	62
ARTS operation	63
Cross-band repeater operation.....	66
Assignment of microphone keys	67
Function's detailed descriptions.....	70
Reset procedure.....	86
Troubleshooting guide.....	87
Technical specifications.....	88
Note on environmental protection.....	90
Declaration of conformity.....	91

Included in the package

- 1 x Radio transceiver
- 1 x Microphone with DTMF keyboard
- 1 x Mobile mounting bracket
- 1 x DC power cord with fuse
- 1 x Controller cable
- 1 x Front panel mounting bracket
- 1 x Set of screws
- 1 x Protection fuse
- 1 x User's manual

Main features

Covers 2 transmitting bands: 144 / 430 MHz

Wide reception bands for AM and FM: 108-180MHz, 134-174MHz, 350-520MHz

Independent controls for both left and right bands

V+U simultaneous reception capability

Built-in V+U cross-band repeater and full duplex capability

800 memory channels with independent settings

50W high power output in VHF band and 40W in UHF band

50 CTCSS tone groups and 104 DCS digital tone groups

User-defined CTCSS and DCS tones capability

Selected calling: DTMF / 2-tones / 5-tones

Companer and encryption functions

Automatic Repeater Shift (ARS)

Detachable front panel and remote mounting capability

Extra-large LCD dual display

User-defined microphone programming keys

Installation

Mobile transceiver installation

To install the transceiver, look for a suitable and secure location inside your vehicle to reduce the risks for the passengers and yourself while the vehicle is in movement. Consider to install the station in an appropriate position so that your knees and your legs will not be able to hit it during a sudden braking manoeuvre of your vehicle. Try to select a well-ventilated location that keeps it protected from direct sunlight.

1- Easy installation

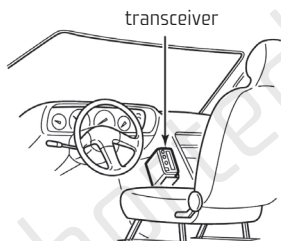

Use the mounting bracket supplied for the main unit.

2- Remote control installation

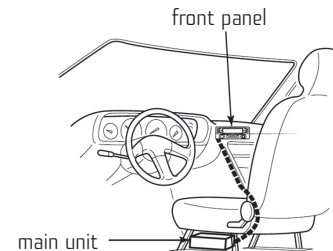

Use the mounting bracket supplied for the front panel and the controller cable.

Mounting bracket installation

1. Drill four holes where you want to install the mounting bracket.
2. Insert the supplied screws with its nut and washer, and tighten them.
3. Adjust the most appropriate angle according to its position.

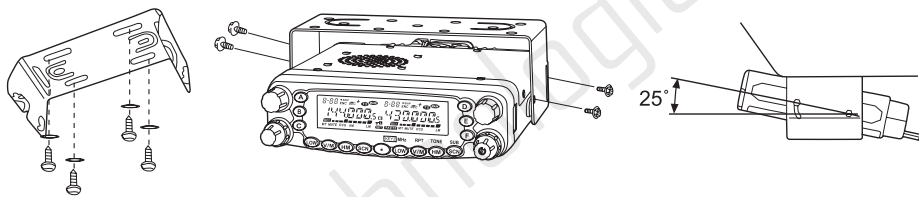

Controller connection

With your TLM-808 a 4,5m controller cable is supplied.

Connect the front panel and the main unit using the controller cable as shown below.

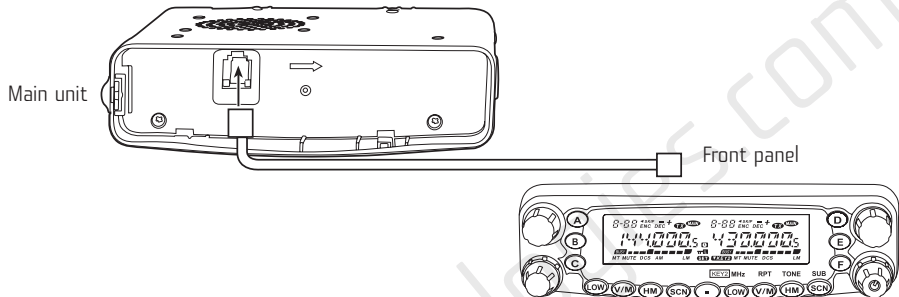

DC Power cable connection

Note: install the connector for power supply as close as possible to the transceiver. The vehicle's battery must be a 12 volts battery. Never connect the transceiver to a 24 volts battery. Make sure to use a 12 volts vehicle battery which has enough power capacity. In case that the power arriving to the transceiver is not enough, the display could turn dark during the transmission, or the output power when transmitting could excessively go down.

1. Route the power cable supplied from the transceiver directly to the vehicle battery terminals using the shortest possible path. We recommend you not to use the cigarette lighter socket as a power source due to some of them may have unacceptable voltage drops. The power cable routing must be installed in a way that it remains isolated from heat, humidity and the engine's ignition system and its cables.
2. With the goal of avoiding the risks of short-circuiting, please, disconnect the negative (-) cable from the battery before connecting the transceiver.
3. Confirm the right polarization from the connections, then fix the power cord to

the battery terminals; the red cable must be connected to the positive (+) terminal, and the black cable must be connected to the negative (-) terminal.

4. Connect again the negative (-) cable from the battery.

5. Connect the supplied power cable to the transceiver's power connector.

Press firmly the connectors until the locking flanges snap.

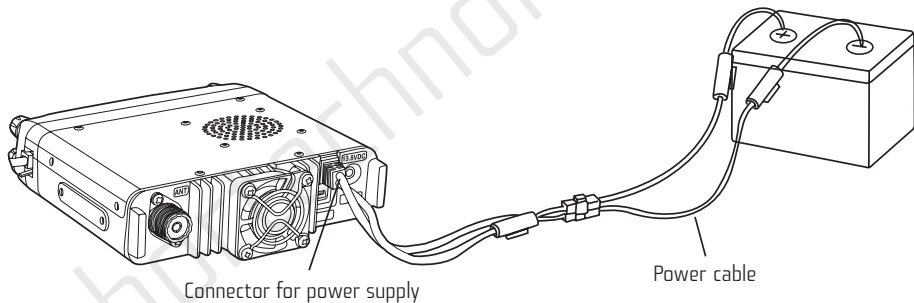

Base station installation

A 13,8V DC power supply (optional, not supplied) is required for operating this transceiver as a base station. Please, contact your dealer.

The current recommended for the power supply is 12A.

1. Connect the power cord to the output terminals on the power supply and make sure the polarity is right. (Red: positive; Black: negative).
 - Do not connect the transceiver directly to a wall outlet.
 - Use the supplied power cord to connect the transceiver to a switching power supply.
 - Do not replace the supplied power cord for another one with a smaller wire size.
2. Connect the supplied power cord plug to the transceiver's power connector.
3. Press firmly the connectors until the locking flanges snap.

Note: before connecting the power cord to the transceiver, make sure to turn off both the transceiver and the power supply.

Do not connect the power supply's power cord to the wall outlet until all the connections are completed.

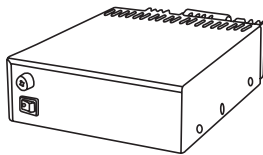

Switching power supply

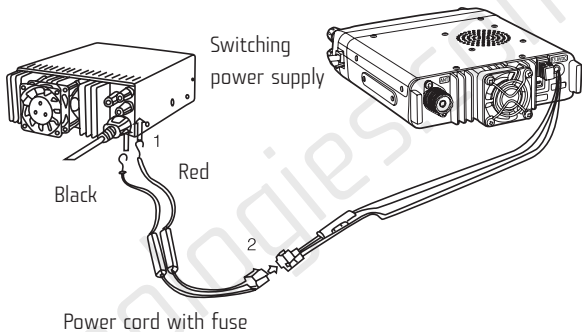

Switching
power supply

Black

Red

Power cord with fuse

Fuse replacement

If a fuse has blown, determine the cause, and then correct the problem. After solving the problem, replace the fuse. If the new installed fuse blows, disconnect the power cord and contact your dealer or an authorised technical service.

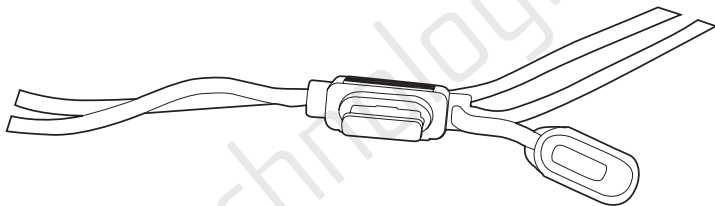

Fuse location	Fuse amperage
Transceiver	15A
Supplied power cord	20A

Use only fuses of the same type and amperage specified, in any other case the transceiver could be damaged.

Note: if you use the transceiver during a long period of time when the vehicle's battery is not fully charged, or when the engine is off, the battery could fully discharge, and maybe will not have enough reserve to start the vehicle. Avoid using the radio under those circumstances.

Antenna connection

Before using the transceiver, install a suitable antenna. The success of the installation will largely depend on the antenna type and its right installation. The transceiver could give excellent results if particular attention is paid to antenna's system and its installation.

Use a low-loss coaxial antenna with an impedance of 50Ω to match the transceiver's input impedance. Connecting the antenna to the transceiver through power lines with an impedance different of 50Ω , the efficiency of the antenna system is reduced and can cause interferences to any other nearby equipment like televisions, radio recep-

tors and other electronic equipments.

Note: transmitting without connecting any antenna or another equivalent charge can damage the transceiver. Always connect the antenna to the transceiver before transmitting. All the base stations should be equipped with a lightning conductor to reduce the risk of fire, electrical discharge and damages on the transceiver.

Accessories connection

External speaker (optional)

In case you want to use an external speaker, it is recommended that you choose one with an impedance of 8Ω . The connector for external speaker accepts connections of 3,5mm (1/8") mono.

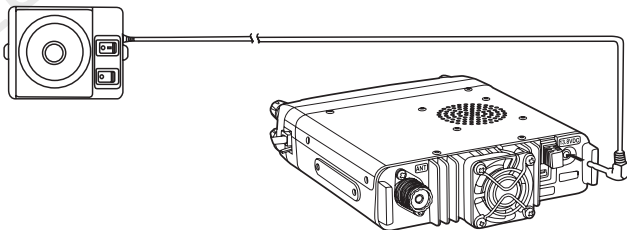

Note: the external speaker take the double BTL port, please, value the connection method. The speaker can not connect with the ground connection, otherwise the speaker could be damaged. The connection method showed below is wrong.

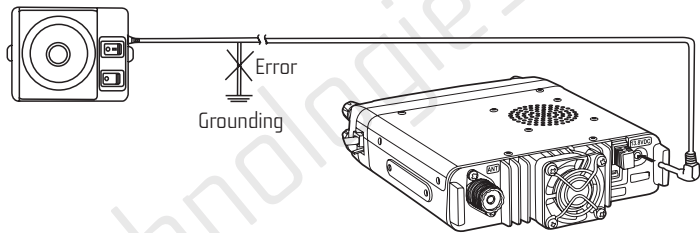

Microphone

For voice communications, connect a microphone equipped with an 8-pin modular connector on the modular connector located on the front of the station. Press firmly the connectors until the locking flanges snap. Fix the supplied microphone on a proper place using the supplied screws.

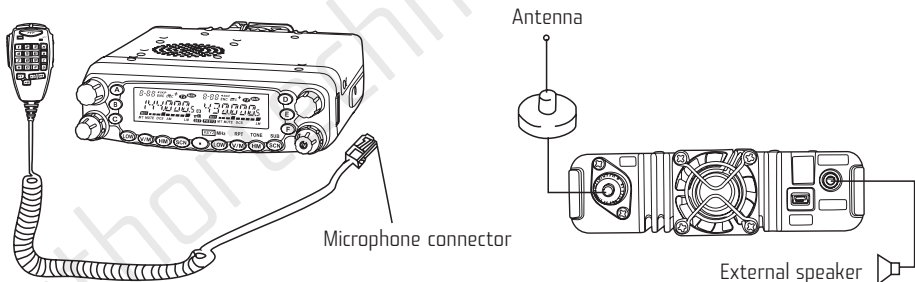

Transceiver's description

Front panel

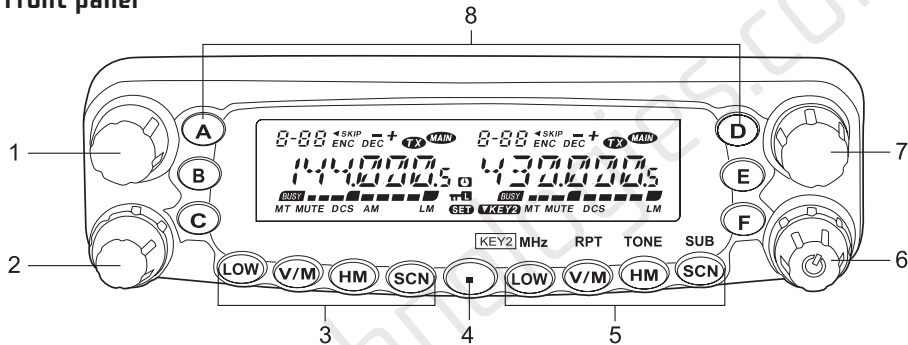

NO.	KEY	FUNCTION
1	Left Control	<ul style="list-style-type: none"> 1. Adjusts left band's dialing. 2. Short-press to adjust left band as the main band. 3. Short-press to adjust (with 1 MHz steps). 4. Keep pressed during half a second to change left operating band between: 144 MHz -> 430 MHz.

2	Left SQL / vol. KEY2	1. The external volume control adjusts the speaker audio level for the left receiver.
		2. Short-press to activate/deactivate the KEY2 mode.
		3. Keep pressed during half a second to lock/unlock the front panel keys.
		4. The internal Squelch control adjusts the noise level for the left receiver.
3	Left LOW	1. Short-press to adjust the left band output power (LOW - MD2 - MD1 - HIGH).
		2. When the left band is adjusted on VFO or MR modes, keep pressed during half a second to activate the priority channel searching.
	Left V/M	1. Short-press to change between VFO and memory modes for the left band's frequency.
		2. When the left band is adjusted on memory mode, keep pressed during half a second to change to "Memory tuning" function.
	Left HM	1. Short-press to recall a frequency from your favourite HOME memory.
		2. When the left band is adjusted on VFO or MR modes, keep pressed during half a second to activate the priority channel searching.

3	Left SCN	1. Short-press to activate the channel's search for the left band.
		2. When the left band is adjusted on MR mode, keep pressed during half a second to set the memory skip search or the preferential memory search.
4	SET	1. Short-press to enter the menu mode.
		2. Keep pressed during half a second to transfer the main CFO band contents to a memory.
5	Right LOW (default)	1. Short-press to adjust the right band output power (LOW - MID2 - MID1 - HIGH).
	Right MHz (mode 2) KEY2	1. When the right band is adjusted on VFO mode (mode 2), short-press to adjust the frequency with 1 MHz steps.
	Right V/M (default)	1. Short-press to change between VFO and memory modes for the right band's frequency.
	Right RPT (mode 2)	1. Short-press to change the frequency shift direction between: RPT -, RPT + or RPT OFF.
		2. Keep pressed during half a second to reverse the Tx and Rx frequencies on the main band during a split-frequency operation.

5	Right HM	1. Short-press to recall a frequency from your favourite HOME memory. 2. When the right band is adjusted on VFO or MR modes, keep pressed during half a second to activate the priority channel searching.
	Right TONE (mode 2) KEY2	Short-press to change the tone's squelch mode between: ENC (CTCSS coding), ENC DEC (CTCSS coding and decoding) or DCS.
	Right SCN (default)	1. Short-press to activate the channel's search for the right band.
		2. When the right band is adjusted on MR mode, keep pressed during half a second to set the memory skip search or the preferential memory search.
	Right SUB (mode 2) KEY2	Short-press to make that the next key to press works on the Sub-Band (the "MAIN" icon will blink on the Sub-Band).
6	Right SQL / vol.	1. The external volume control adjusts the speaker audio level for the right receiver.
		2. Keep pressed during half a second to power on/off the transceiver.
		3. The internal Squelch control adjusts the noise level for the right receiver.
7	Right control	1. Adjusts right band's dialing.
		2. Short-press to adjust right band as the main band.
		3. Short-press to adjust (with 1 MHz steps).
		4. Keep pressed during half a second to change right operating band between: 144 MHz -> 430 MHz

8	Hyper memory keys	<ol style="list-style-type: none">1. Keep pressed any of this keys during about two seconds to store the radio current configuration in one of the special "Hyper" memory banks.2. Short-press any of this keys to recall the information stored on the desired "Hyper" memory bank.
---	--------------------------	---

Introduction to display's icons

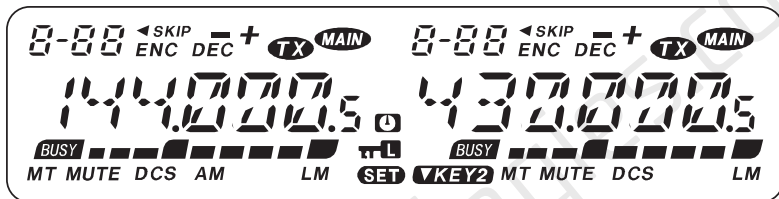

N°	Icon	Function
1	0-00	Memory channel number
2	◀	Preferential memory channel
3	SKIP	Skip memory channel
4	-	Negative shift direction
5	+	Positive shift direction
6	-+	"Odd Splits"
7	ENC	CTCSS coding

8	DEC	CTCSS decoding
9	TX	Transmitting
10	MAIN	Main band
11	BUSY	Busy channel (or Squelch off)
12	MT	Memory tuning
13	MUTE	Audio mute
14	DCS	DCS digital code
15	AM	AM reception
16	L	Low power output
17	M	Medium power output
18	⏻	Automatic power off
19	⏻L	Keyboard lock
20	SET	Menu set
21	▼KEY2	Mode 2 key on

Back view



N°	Connector	Function
1	ANT	Connection for a 50Ω antenna.
2	EXT SP	Connection for an optional external speaker.
3	DATA	Connection for programming via PC.

Microphone

See information on next page

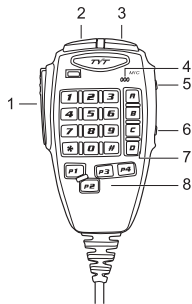

N°	Key	Function
1	PTT button	Press button to transmit.
2	DWN button	Tune down the channel number or set value.
3	UP button	Tune up the channel number or set value.
4	MIC	Talk to this during transmission.
5	LOCK	Lock microphone keys except 0-9 and PTT button.
6	LAMP	Lights up the microphone keypad.
7	Numeric keys	To introduce channel number, DTMF code, etc.
8	Programmable keys	User-defined programming keys. By default: P1: toggle main band between right or left bands. P2: on main band, toggle between VFO and frequency modes. P3: on main band, select between CTCSS or DCS. P4: on main band, select the output power level.

Basic functions

Power on/off the transceiver

To power on the transceiver, keep pressed the Right **VOL/SQL** during half a second.

To power off the transceiver, keep pressed the Right **VOL/SQL** during half a second.

Setting the volume

Turn the external volume control clockwise to increase the volume, and turn it counter-clockwise to decrease the volume.

Note:

1. During communication, the volume can be set more accurately.
2. The audio volume level is independently adjusted through the external left and right volume controls.

Setting the squelch level

Turn the internal SQL control clockwise to increase receiver's background noise, and turn it counter-clockwise to decrease receiver's background noise.

Note: The background noise level is also independently adjusted through the internal left and right SQL controls.

Selecting the operating band

By default, the TLM-808 operates on the dual reception mode. During the operation on dual reception mode, the main frequency band (in which is possible to transmit), is shown through the “**MAIN**” icon.

Short-press the [P1] microphone key or press the left or right controls, the “**MAIN**” icon will be shown alternately both sides of the display each time you toggle the main band from left to right side, and vice versa.

Note: short-press the left **VOL/SQL** button to activate or deactivate the simple reception mode. When is activated, the operating voltage will be shown on the Sub-Band, the **▼KEY2** icon will be shown on the display and the keys: [LOW], [V/M], [HM] and [SCN] left and; [MHz], [RPT] y [TONE] right will be valid for the operating band.

Selecting the frequencies band

Keep pressed the left control during half a second to change left operating band between 144 MHz and 430 MHz.

Keep pressed the right control during half a second to change right operating band between 144 MHz and 430 MHz.

Note: if necessary, the TLM-808 can operate on a V-V or U-U mode V - V o U - U.



VHF-VHF Operation (V - V)



UHF-UHF Operation (U - U)

Setting a frequency

1. Turning the main control

In VFO mode, turning the main control it will allow you to change the frequency through the frequency step programmed for the operating band. Turning it clockwise the frequency will increase, while turning it counter-clockwise the frequency will decrease.

In the main frequency band, short-press the main control and next turn it to change the main band frequency in 1 MHz frequency steps. This function is useful to make fast sweeps through all the frequency range of your TLM-808.

2. Direct frequency entry through the microphone keypad

The keypad of your DTMF microphone can be used to directly introduce the main band frequency. To introduce a frequency through the keypad, you should only to press the appropriate numbers in the right sequence.

Receiving a call

When you receive a call in the selected channel, the **BUSY** icon appears on the display.

Note: if you have selected a high level of squelch you may have problems to hear the call.

Transmitting a call

To transmit, keep the microphone at approximately 2,5 – 5 cm from your mouth, then press the PTT button and next talk to the microphone with a normal tone of voice.

Note: while keeping pressed the PTT button, the orange colour of the led indicator and the power strength on the radio display will denote that you are transmitting

Setting the transmission power level

To change the output power level, press the [LOW] key to select one of the four power settings. The selected power level will be stored in the memory once you proceed to store it.

LOW	MID 2	MID 1	HIGH
5 W	10 W	20 W	50 W / UHF: 40 W

During a transmission, the power strength will be shown on the display according with the output power selected.

Note: you can change the main band's output power level using the [P4] microphone key.

Memory functions

Your TLM-808 provides four kinds of memory systems, which are the following: 800 standard memory channels numbered from 001 to 800. 5 pairs of Band-Edge memories (memories allowing to limit a search between a minimum and a maximum frequencies) labelled from “L1/U1” to “L5/U5”. 6 HOME memories providing a storage and a quick access for one main frequency for each of the operating bands. 6 Hyper memories that can be recalled through the [A] – [F] keys.

Storing memory channels

1. In the main band, select the desired frequency as well as the CTCSS tones, DCS codes, frequency shift direction and the output power level in the VFO operating mode.
2. Keep pressed the **SET** key during half a second to start the memory storing. A memory number will start blinking on the upper side of the screen.
3. Use the main band control or the [UP] / [DWN] microphone keys to select the memory number where you want to store the data.

4. Keep pressed once again the **SET** key during half a second to add an alphanumeric label to the memory. Turn the main band control to select the first character of the name you want to store, short-press the control or the [UP] microphone key to advance to the next character. The available characters comprise the digits from 0 to 9, the letters from A to Z and the *, +, -, / and x symbols.
5. Short-press once again the control or the [UP] microphone key to advance to the next character. If you want to correct a character, short-press the [DWN] microphone key to move back to the last character, re-select a new character.
6. Repeat the last steps to complete the label with the letters, numbers or symbols you wish. You will be able to use up to six characters.
7. Once you have completed the label, short-press the **SET** key to store the label and return to normal operation mode.

Note: in case you do not want to add an alphanumeric label to the memory, after step 3, press straightaway the **SET** key to store the data and return to normal operation mode.

Separate Transmit Frequency Memory (“Odd Splits”)

1. Store the receiving frequency following the steps described above.
2. Change to the desired transmission frequency in main band, next keep pressed the **SET** key during half a second.
3. Use the main band control or the [UP] / [DWN] microphone keys to select the same memory number you have used in step 1.
4. Keep pressed the PTT button, next short-press the **SET** key while pressing the PTT button to store the data and return to normal operation mode. The **— +** icon is showed on the display

Note: when you recall a memory storing independent reception and transmission frequencies, the **— +** icon will be shown on the display.

Memory recall

In VFO mode, short-press the [V/M] key to enter the memory mode. Turn the control or introduce the channel number through the microphone keypad to select the

desired channel.

Memory tuning

1. In MR mode, select the desired channel.
2. Keep pressed the [V/M] key during half a second, the **MT** icon will be shown on the display.
3. Turn the control to select a new frequency. The steps you make in the current band for VFO operation will be the steps used during the memory tuning.
4. Short-press once again the [V/M] key to exit the memory tuning and return to the memory number previously selected, the **MT** icon will disappear from the display

Deleting a memory

1. Short-press the [V/M] key to enter the memory mode.
2. Keep pressed the **SET** key during half a second, turn the main band control to select the desired memory channel. You will notice that the number 1 memory channel can not be deleted.

3. Short-press the main band [SCN] key to delete the selected memory channel. The radio will return again to number 1 memory channel, if you try to select the memory number you have just deleted, you will notice it does not exist.

HOME memory channel

The TLM-808 allows you to quickly recall your favourite operation frequency for each one of the bands, it is called HOME memory channel.

1. In the main band, select the desired frequency as well as the CTCSS tones, DCS codes, frequency shift direction and the output power level in the VFO operating mode.
2. Keep pressed the **SET** key during half a second to start the memory storing. A memory number will start blinking on the upper side of the screen.
3. Short-press the main band [HM] key to store the frequency data on the special register for the HOME memory channel.
4. Repeat the last steps for the other operating bands.
5. To recall a HOME memory channel, while operating both in the VFO mode and the

MR mode, press the [HM] key.

Hyper memory channel

The TLM-808 allows you to store all the radio current configuration settings in a special memory bank called Hyper, including the operating frequency, CTCSS tones, DCS codes, repeater shift, power level, search settings, menu settings, etc. for both left and right bands.

1. Set the desired configuration for both left and right bands.
2. Keep pressed one of the Hyper memory [A] – [F] keys during a few seconds to store all the radio current configuration settings in the desired Hyper memory channel.
3. To retrieve the data from a Hyper memory channel, press the suitable Hyper memory [A] – [F] key.

Please, store the radio current configuration settings in the desired Hyper memory channel before trying to retrieve the data to avoid losing the current configuration.

Memory only mode

When proceeding to store memory channels, you can set your radio in a Memory only mode, where the operation in VFO mode will not be possible. That can be especially useful during public events, where a substantial number of persons are using the radio for the first time, and you want the maximum simplicity in selecting channels.

1. Power off the transceiver.
2. While keeping pressed the left band [V/M] key, power on the transceiver.
3. Turn the main control to select the [F-5 M-ONLY MODE], next press the **SET** key to confirm. The radio will restart and enter the Memory only mode.
4. To return to the normal operation mode, repeat the last steps.

Advanced functions

Repeater operation

The TLM-808 provides the useful ARS (Automatic Repeater Shift) function, which automatically applies the suitable repeater shift each time it tunes in the Sub-Bands designed for each repeater.

For activating ARS:

1. Short-press the **SET** key to enter the menu mode.
2. Turn the main control to select menu number 2 (ARS).
3. Short-press the main band control, next turn the main control to change the setting to “ON”.
4. Short-press the **SET** key to store the new setting and return to normal operation mode.

If the ARS function has been deactivated, or if you need to set another different repeater shift from the one set in this function, you will be able to manually set the repeater shift:

1. Short-press the **SET** key to enter the menu mode.

2. Turn the main control to select menu number 24 (RPT.MOD).
3. Short-press the main band control, next turn the main control to select the repeater shift between "+", "-" and "OFF".
4. Short-press the **SET** key to store the new setting and return to normal operation mode.

And in case you travel to another region, you should need to change the default repeater shift setting to ensure compatibility with local operator requirements.

1. Short-press the **SET** key to enter the menu mode.
2. Turn the main control to select menu number 27 (SHIFT).
3. Short-press the main band control, next turn the main control to select the repeater shift value between 0 and 99,5 MHz.
4. Short-press the **SET** key to store the new setting and return to normal operation mode.

CTCSS tones / DCS codes operation

Adjusting the CTCSS tones implies two actions: adjusting the tone mode and adjusting the tone frequency through the menu number 31 (TONE M) and number 30 (TONE F), respectively.

1. Short-press the **SET** key to enter the menu mode.
2. Turn the main control to select menu number 31 (TONE M).
3. Short-press the main band control, next turn the main control to select the tone mode value between ENC: CTCSS coding and ENC.DEC: CTCSS coding and decoding.

Note: you can select tone mode (ENC, ENC.DEC) for the main band through the [P3] microphone key.

4. Once the CTCSS tone mode selection is completed, short-press the main band control to confirm, next turn the main band control to select menu number 30 (TONE F). This menu is used to set the tone frequency.
5. Short-press the main band control to allow the CTCSS frequency setting.
6. Turn the main control until you see the CTCSS frequency you need to use on the display.

7. Short-press the **SET** key to store the new setting and return to normal operation mode.

50 groups of Standard CTCSS Tone Frequencies (Hz):

50 groups of Standard CTCSS Tone Frequency (Hz)						
67.0	69.3	71.9	74.4	77.0	79.7	82.5
85.4	88.5	91.5	94.8	97.4	100.0	103.5
107.2	110.9	114.8	118.8	123.0	127.3	131.8
136.5	141.3	146.2	151.4	156.7	159.8	162.2
165.5	167.9	171.3	173.8	177.3	179.9	183.5
186.2	189.9	192.8	196.6	199.5	203.5	206.5
210.7	218.1	225.7	229.1	233.6	241.8	250.3
254.1	-	-	-	-	-	-

As with the CTCSS tones, adjusting the DCS codes require adjusting the tone mode to DCS and next selecting the code.

1. Short-press the **SET** key to enter the menu mode.
2. Turn the main control to select menu number 31 (TONE M).
3. Short-press the main band control, next turn the main control to select the tone mode value DCS: DCS coding and decoding.

Note: you can select tone mode (DCS) for the main band through the [P3] microphone key.

4. Once the DCS tone mode selection is completed, short-press the main band control to confirm, next turn the main band control to select menu number 7 (DCS.COD). This menu is used to set the DCS code.

5. Short-press the main band control to allow the DCS frequency setting.

6. Turn the main control until you see the DCS code you need to use on the display.

7. Short-press the **SET** key to store the new setting and return to normal operation mode.

Note: the DCS codes work with coding and decoding system, that way your transceiver will remain mute until a transmission with a matching DCS code is received.

104 groups of Standard DCS code numbers:

104 groups of Standard DCS Code Number											
023	025	026	031	032	036	043	047	051	053	054	065
071	072	073	074	114	115	116	122	125	131	132	134
143	145	152	155	156	162	165	172	174	205	212	223
225	226	243	244	245	246	251	252	255	261	263	265
266	271	274	306	311	315	325	331	332	343	346	351
356	364	365	371	411	412	413	423	431	432	445	446
452	454	455	462	464	465	466	503	506	516	523	526
532	546	565	606	612	624	627	631	632	654	662	664
703	712	723	731	732	734	743	754	-	-	-	-

DCS codes inversion

In those cases where you detect that receiver's squelch not opening when both of you and another radio are using a common DCS code, you can try the following:

1. Short-press the **SET** key to enter the menu mode.
2. Turn the main control to select menu number 8 (DCS.N/R).
3. Short-press the main band control, next turn the main control to select between:

TRX N: normal DCS coding and decoding;

RX R: normal DCS coding and inverted DCS decoding;

TX R: inverted DCS coding and normal DCS decoding;

TRX R: inverted DCS coding and decoding;

4. Short-press the **SET** key to store the new setting and return to normal operation mode.

CTCSS / DCS search scanning

When operating in a situation where you do not know the CTCSS or DCS tone another radio or radios are using, you can ask your radio to listen the incoming calls and to search for the tone is been used. Works both in VFO and Memory modes.

To search for the tone is been used:

1. Set the radio for operating with CTCSS or DCS decoding. In case of CTCSS the “ENC. DEC” icon will be shown on the display; in case of DCS the “DCS” icon will be shown on the display.
2. Short-press the **SET** key to enter the menu mode.

3. Turn the main control to select menu number 30 (TONE F) in case using CTCSS or menu number 7 (DCS.COD) in case using DCS.
4. Short-press the main band control, next turn the main control to enter the setting.
5. Press the main band [SCN] key to start the search of CTCSS tone or DCS code.
6. When the radio detects the right tone or code, it will stop in this tone or code and you will start to hear the call. Short-press the main band control to lock that tone or code and next short-press the **SET** key to store the new setting and return to normal operation mode.

Note: if the tone search do not detect any tone or code, it will continue searching. When this happens, the reason could be that the other radio is not sending any tone. Press the **SET** key at any time to stop the search.

User-defined CTCSS tones / DCS codes

The TLM-808 has the possibility to use user-defined CTCSS tones or DCS codes.

For CTCSS tones:

1. Short-press the **SET** key to enter the menu mode.

2. Turn the main control to select menu number 30 (TONE F), short-press the main band control to enter the setting.
3. Introduce the code number directly through the microphone keypad. The range is between 67.0 and 254.1 Hz.
4. Short-press the **SET** key to store the new setting and return to normal operation mode.

For DCS tones:

1. Short-press **SET** key to enter the menu mode.
2. Turn the main control to select menu number 7 (DCS.COD), short-press the main band control to enter the setting.
3. Introduce the code number directly through the microphone keypad. The range is between 023 and 754 normal and inverted.
4. Short-press the **SET** key to store the new setting and return to normal operation mode.

Searching

The TLM-808 allows you to scan both in the memory channels of the whole operating band, and on a section of this band. It will stop in any signal found, that way you will allow to communicate with the radios of that frequency, if you wish it.

Before starting the search, select the way you want the scanner to resume the search after stopping in a signal.

To set the search resume mode:

1. Short-press the **SET** key to enter the menu mode.
2. Turn the main control to select menu number 25 (SCAN).
3. Short-press the main band control, next turn the main control to select between:
TIME: the scanner will stop in a signal found, and will wait for 5 seconds. If you do not make any action during this period, the scanner will resume the search although the signal remains active.
BUSY: the scanner will stop in a signal found, and 2 seconds after the communication has finished because the transmission between the other radio or radios has ended, the search will resume.

4. Short-press the **SET** key to store the new setting and return to normal operation mode.

Note: the default setting for resuming the search is “TIME”.

VFO search

1. If necessary, select the VFO mode by pressing the [V/M] key.
2. Press the [SCN] key to start the search.
3. Turn the main control to change the frequency search direction.
4. When the scanner finds a strong enough signal to open the squelch, the scanner will temporarily stop, and during this pause the frequency's decimal point will blink.
5. The scanner will resume the search according to the selected setting in the preceding paragraph.

To cancel the search, press the [SCN] key again.

Memories search

If necessary, select the Memory mode by pressing the [V/M] key.

Press the [SCN] key to start the search.

In the same way as in mode VFO, when the scanner finds a strong enough signal to open the squelch, the scanner will temporarily stop, and will resume the search according to the selected setting for the search resume.

To cancel the search, press the [SCN] key again.

Memory skip search

Some radios transmit continuously, so that seriously interfere in a search operation and, if you want, you can skip it during the search.

1. If necessary, select the Memory mode by pressing the [V/M] key.
2. Turn the main control to select the memory channel you want to skip.
3. Keep pressed the [SCN] key during half a second and the **SKIP** icon will be shown on the display. The current memory channel will be ignored during the search. The **SKIP** icon will also be shown when you manually select a channel you want to skip.
4. To deactivate a channel skip, keep pressed the [SCN] key during half a second to cancel the channel skip.

Preferential memory search

You can set a preferential memory search list at which you can call on Memory mode.

These channels, once they are set, are designed by the ◀ icon.

When you select the preferential memory search mode, just the channels designated with the ◀ icon will be searched.

How to set and use the preferential memory search list:

1. If necessary, select the Memory mode by pressing the [V/M] key.
2. Turn the main control to select the memory channel you want to add to the preferential memory search list.
3. Keep pressed the [SCN] key during half a second, several times if necessary, until the ◀ icon will be shown on the display.

To start the preferential memory search:

1. Short-press the **SET** key to enter the menu mode.
2. Turn the main control to select menu number 26 [SCAN M].
3. Short-press the main band control, next turn the main control to select “MSM”.

4. Short-press the **SET** key to store the new setting and return to normal operation mode.
5. Now, press the [SCN] key to start the preferential memory search. Only the channels designated with the ◀ icon will be searched.
6. To cancel the preferential memory search, on step 3 select “MEM”.

Exploring programmed memories

This feature allows you to set Sub-Band limits, whether it is for exploring or manually activating the VFO operation.

1. If necessary, select the Memory mode by pressing the [V/M] key.
2. Store the frequency 1 on #L1 Memory Channel (the “L” represents the lower Sub-Band limit).
3. In the same way, store the frequency 2 on #U1 Memory Channel (the “U” represents the upper Sub-Band limit).
4. Change to Memory mode by pressing once the [V/M] key, next, turn the main control to select the #L1 Memory Channel.

5. Keep pressed the [V/M] key during half a second to start operation, the “MT” icon will be shown on the display. The tuning and exploring are now limited within the range you have programmed.

6. You have five pairs of Sub-Band limit memories available, numbered from L1/U1 to L5/U5. Therefore, if you wish, you can set upper and lower limits for different bands.

Note: Please, make sure that the #L1 frequency is lower than the #U1 frequency and that both of them are on the same frequency band. If not, it will not be valid.

Priority channel searching (Dual Watch)

The TLM-808 includes a search function on two channels that allows you to operate on any of the VFO, Memory or Home channel modes, while periodically check the activity on a user-defined priority memory channel.

VFO priority

1. Recall the memory channel that you wish you use as priority frequency.
2. If necessary, select the VFO mode by pressing the [V/M] key.

3. Keep pressed the [HM] key during half a second to activate the VFO priority mode. The display will remain on the current VFO frequency, but every 5 seconds it will check if there is any activity on priority memory channel.
4. Press the [V/M] key to deactivate the VFO priority mode and return to normal operation mode.

Memory priority

1. Store the frequency you wish to be priority channel in the memory channel 1.
2. Set your transceiver in any other memory channel.
3. Keep pressed the [HM] key during half a second to activate the Memory priority mode. The display will remain on the current Memory frequency, but every 5 seconds it will check if there is any activity on priority memory channel (memory channel 1).
4. Press the [V/M] key to deactivate the Memory priority mode and return to normal operation mode.

DTMF operation

The TLM-808 has two different methods to initiate the DTMF signalling.

1 - Using the numeric keys on the microphone

Keeping pressed the PTT button, introduce directly the telephone number of the other(s) radio(s) through the numeric keys on the microphone: 0-9, *, #, A, B, C, D.

2 - Using the auto-dialling DTMF function

There are 16 auto-dialling DTMF memories. Each one of these auto-dialling DTMF memories can store one telephone number up to 16 digits, to make calls via repeater to telephones or other uses.

To store auto-dialling DTMF memories:

1. Short-press the **SET** key to enter the menu mode.
2. Turn the main control to select menu number 12 (DTMF W).
3. Short-press the main band control, next turn the main control to select auto-dialling DTMF memory number (from “d-1” to “d-16”) in which you want to store the

telephone number.

4. Short-press the main band control, next turn the main control to select the first digit from the telephone number you want to store.

5. Once you have selected the right digit, press the main band control to confirm. Next turn the main control to select the second from the 16 available digits on the current auto-dialling DTMF memory registry.

6. Repeat this procedure for each one of the digits from telephone number. If an error occurred, press the [DWN] microphone's key to return to first digit, and next reintroduce the correct number. By pressing the [SCN] key you will erase the previous digit.

7. When you have finished to introduce all the digits, press the **SET** key to store the new setting.

8. If you would like to store a new DTMF code, turn the main control until you select another auto-dialling DTMF memory, and then repeat the previous steps from 4 to 7.

9. Once you have stored the wished auto-dialling DTMF memories, press the **SET** key to store the new setting and return to normal operation mode.

To transmit the stored telephone numbers:

1. Short-press the **SET** key to enter the menu mode, turn the main control to select the auto-dialling DTMF memory that will be transmitted through menu number 12 (DTMF W).
2. Press the **SET** key to store the new setting and return to normal operation mode.
3. Keeping pressed the PTT button, press the main band [HM] key to transmit the tone.

Once you have pressed the [HM] key in the previous step, you can release the PTT button, since the auto-dialling will transmit automatically all the DTMF code.

And you can set both the data rate of the DTMF digits and the delay time between you press the [HM] key (while pressing the PTT button) and when the first digit is sent, respectively through the menus number 11 (DTMF S) and number 10 (DTMF D).

2-tones and 5-tones signals operation

The difference between the operation with 2 or 5 tones and DTMF is that the 2 or 5 tones can be sent using only the auto-dialling function, not through the numeric

keys on the microphone. And you can store the auto-dialling memories through the programming software, but you can not make it manually.

To transmit the memorized 2 or 5 tones signals:

1. Select the 2-tones memorized channel through menu number 38 [2 TONE] or the 5-tones through menu number 39 [5 TONE].
2. Keeping pressed the PTT button, press the main band [LOW] key to transmit the 2-tones signal; press the main band [V/M] key to transmit the 5-tones signal.

ARTS operation

When you and another radio equipped with the ARTS function are within the communication range, the ARTS function, use a DCS code to inform both radios. This can be particularly useful during search and rescue situations, where is really important to keep in contact with the other group members.

Both radios need to set their DCS codes on the same code number, then need to activate their ARTS functions using in any case the appropriate command.

Each time you press the PTT button, or 25 seconds after ARTS function is activated,

your radio will transmit a signal that will contain during one second the DCS code. If the other radio is inside the range, the locator will sound (if is activated) and the “IN.RNG” message will be shown on the display instead of the out of range “OUT.RNG” message showed when the ARTS operation began.

If you move out of range during more than a minute, your radio will notice no signal has been received, three beep will sound and the “OUT.RNG” message will be shown again on the display. If you return inside of range, your radio will play a beep again and the “IN.RNG” message will be shown again on the display.

During the ARTS operation, it is not possible to change the operating frequency or any other setting on the main band; you must stop ARTS in order to return to normal operation mode.

For activating ARTS:

1. Set both your radio and the other radios with the same DCS code number.
2. Short-press the **SET** key to enter the menu mode.
3. Turn the main control to select menu number 3 (ARTS).

4. Short-press the main band control, next turn the main control to select the ARTS warning option between:

IN.RNG: the warnings are only emitted when the radio first confirms is inside of range, but from then on does not reconfirm with warnings.

ALWAYS: each time receiving an exploration transmission from another radio, you will hear the alert warnings.

5. Short-press the main band control to confirm the setting, and the “OUT.RNG” message will be shown on the display. The ARTS operation has begun.

6. Every 25 seconds, your radio will transmit an exploration transmission to the other radios. When the other radios do not reply with their own exploration signal, the display will change to “OUT.RNG” message to confirm that no exploration signal from another radio has been received replying to his.

7. Short-press the **SET** key to exit the ARTS operation and return to normal operation mode.

Cross-band repeater operation

The TLM-808 can be set to operate as a cross-band repeater through a simple menu procedure. This is a useful function for emergency works in remote areas, as well as for cross-band connections.

Note:

1. Check the rules and regulations of your country to ensure that this kind of operations are permitted.
2. Choose carefully your pair of frequencies, in order to avoid causing interferences to other users. If you are not sure of activating repeater frequencies in your area, a safe rule is to keep far from repeater Sub-Bands and using the FM simplex section of each band. Contact the frequencies coordinator in your area for assistance.
3. Keep in mind that the transmission working cycle will be much greater during the repeater service, so we recommend you to set a low level of transmission power in order to avoid an over-heating.

How to set the cross-band repeater operation:

1. Set up both bands settings as you like, and the squelch in order that the background noise gets silenced before the cross-band repeater operation.
2. Short-press the **SET** key to enter the menu mode.
3. Turn the main control to select menu number 35 [X-PRT].
4. Short-press the main band control, and the “XSTART” message will be shown on the display.
5. Press the main band control again for activating the cross-band repeater mode. Now the “MAIN” icon will not be shown on the display. And both right and left bands can be used for transmitting or receiving.
6. Short-press the **SET** key to exit the cross-band repeater mode and return to normal operation mode.

Assignment of microphone keys

The user can assign different functions to the microphone keys of the TLM-808, just

in case you wanted to use any other function in any of these keys.

To assign a function to a key:

1. Short-press the **SET** key to enter the menu mode.
2. Turn the main control to select any of the menu numbers from 19 to 22 (19 – PG P1, 20 – PG P2, 21 – PG P3, 22 – PG P4).
3. Short-press the main band control, next turn the main control to select the function you want to assign to the key selected in the previous step.
4. Short-press the **SET** key to confirm the setting, and if you want to modify another programmable key, repeat the previous steps.
5. Short-press the **SET** key to store the new setting and return to normal operation mode.

Name	Function
SCAN	Enables the search function on main band.
SQL.OFF	Opens main band squelch to allow a non-silenced reception.

TCALL	Enables the 1750 Hz tone for repeaters accessing (with the programming software, you can select between 1000 / 1450 / 1750 / 2100 Hz).
RPTR	Selection of main band shift direction.
PRI	Enables main band priority channel.
TONE	Enables the CTCSS/DCS main band operation.
MHZ	Enable the 1 MHz main band frequency steps.
REV	Enables the main band reverse frequency.
HOME	Switch main band Home channel.
BAND	Switch main band operation between left and right bands.
VFO/MR	Switch between main band VFO and Memory modes.

Function's detailed descriptions

Using the menu

1. Short-press the **SET** key to enter the menu mode.
2. Turn the main control to select the menu number you wish to adjust (you can also introduce directly the menu number through the microphone keypad).
3. Short-press the main band control, next turn the main control to change the wished setting.
4. Short-press the **SET** key to store the new setting and return to normal operation mode.

1.- Automatic Power Off - APO

Function: sets the time for equipment's automatic power off.

Available values: OFF / 0,5H / 1,0H / 1,5H / 2,0H

Default value: OFF

2.- Automatic Repeater Shift - ARS

Function: enables or disables the automatic repeater shift function.

Available values: ON / OFF

Default value: OFF

3.- ARTS

Function: selection of the ARTS warning.

Available values: IN.RNG / ALWAYS

IN.RNG: the warnings are only emitted when the radio first confirms is inside of range, but from then on does not reconfirm with warnings.

ALWAYS: each time receiving an exploration transmission from another radio, you will hear the alert warnings.

4.- BEEP

Function: enables or disables the keypad beep emitting function.

Available values: BEP.ON / BEP.OFF

Default value: BEP.ON

5.- CPU clock frequency - CLK.SFT

Function: sets the CPU clock frequency.

Available values: SFT.ON / SFT.OFF

Default value: SFT.OFF

6.- DIMMER

Function: sets the display brightness level.

Available values: DIM OFF / DIM 01 / DIM 02 / DIM 03 / DIM 04

Default value: DIM 04

7.- DCS.COD

Function: sets the DCS codes.

Available values: 104 standard DCS codes.

Default value: DCS.023

8.- DCS.N/R

Function: sets the normal or inverted DCS codes.

Available values: TRX N / TX R / RX R / TRX R

Default value: TRX N

9.- DSP.MOD

Function: sets the memory channel display mode.

Available values: DSP.FRQ / DSP.NAM

Default value: DSP.FRQ

10.- DTMF D

Function: sets the delay time for sending the first DTMF digit.

Available values: 50 / 100 / 250 / 450 / 750 / 1000 ms

Default value: 450 ms

11.- DTMF S

Function: sets the speed for sending the DTMF digits.

Available values: 50 / 75 /100 ms

Default value: 50 ms

12.- DTMF W

Function: stores the auto-dialling DTMF memories.

There are 16 auto-dialling DTMF memories available.

13.- HYPER

Function: enables or disables the Hyper memory automatic writing.

Available values: MANUAL / AUTO

Default value: MANUAL

14.- KEY.MOD

Function: switches the right band function keys functions.

Available values: KEY 1 / KEY 2

Default value: KEY 1

15.- LOCK

Function: enables or disables the keyboard lock.

Available values: MANUAL / AUTO

Default value: MANUAL

16.- LOCKT

Function: enables or disables the PTT button lock.

Available values: OFF / BAND R / BAND L / BOTH

Default value: OFF

OFF: enables the PTT button.

BAND R: disables the PTT button in right band.

BAND L: disables the PTT button in left band.

BOTH: disables the PTT button in both bands.

17.- MUTE

Function: sets the audio mute mode.

Available values: OFF / TX / RX y TX/RX

18.- NAME

Function: stores an alphanumeric label for a memory channel.

19.- PG P1

Function: programs the P1 key function.

Default value: BAND / VFO / MR / OFF / SCAN / SQL OFF / TCALL / RPTR / PRI / LOW /
TONE / MHZ / REV / HOME / BAND

20.- PG P2

Function: programs the P2 key function.

Default value: VFO / MR / OFF / SCAN / SQL OFF / TCALL / RPTR / PRI / LOW / TONE /
MHZ / REV / HOME / BAND

21.- PG P3

Function: programs the P3 key function.

Default value: TONE / MHZ / REV / HOME / BAND / VFOMR / OFF / SCAN / SQL OFF /
TCALL / RPTR / PRI / LOW

22.- PG P4

Function: programs the P4 key function.

Default value: LOW / TONE / MHZ / REV / HOME / BAND / VFOMR / OFF / SCAN / SQL
OFF / TCALL / RPTR / PRI

23.- RF SQL

Function: sets the RF squelch level.

Available values: OFF / S-2 / S-5 / S-9 / S-FULL

Default value: OFF

Note: the RF squelch level can be independently set for both left and right bands.

24.- RPT.MOD

Function: sets the repeater shift direction.

Available values: RPT.OFF / RPT.- / RPT.+

Default value: RPT.OFF

25.- SCAN

Function: sets the search resume mode.

Available values: TIME / BUSY

Default value: TIME

TIME: the scanner will stop in a signal found, and will wait for 5 seconds. If you do not make any action during this period, the scanner will resume the search although the signal remains active.

BUSY: the scanner will stop in a signal found, and 2 seconds after the communication has finished because the transmission between the other radio or radios has ended, the search will resume.

26.- SCAN MODE

Function: sets the memories search mode.

Available values: MEM / MSM

Default value: MEM

MEM: enables the memory search in all memory channels (except the ones marked to be skipped during the search).

MSM: enables the memory search only for preferential channels.

27.- SHIFT

Function: sets repeater shift.

Available values: 0,00 – 99,5 MHz

Default value: 600 KHz (UHF), 600 Hz (VHF)

Note: the repeater shift can be independently set for both left and right bands.

28.- STEP

Function: sets the frequency steps.

Available values: 2,5 / 5 / 6,25 / 7,5 / 8,33 / 10 / 12,5 / 15 / 20 / 25 / 30 / 50 / 100 KHz

Default value: 12,5 KHz

Note: the frequency steps can be independently set for both left and right bands.

29.- SPK

Function: sets the silencing mode (squelch).

Available values: SQ / CTC / TON / C+T y C/T

Default value: SQ

SQ: opens squelch when receiving a matching signal.

**CTC:* opens squelch when receiving a matching signal with exactly the same CTCSS tone / DCS code.

**TON:* opens squelch when receiving a matching signal with exactly the same DTMF / 2TONE / 5TONE signal.

**C+T:* opens squelch when receiving a matching signal with exactly the same CTCSS tone / DCS code and exactly the same DTMF / 2TONE / 5TONE signal.

C/T: opens squelch when receiving a matching signal with either the same CTCSS tone

/ DCS code or the same DTMF / 2TONE / 5TONE signal.

*It has to be previously activated to be displayed on the display

30.- TONE F

Function: sets the CTCSS tone frequency.

Available values: 50 standard CTCSS tones.

Default value: 100 Hz

Note: the CTCSS tone can be independently set for both left and right bands.

31.- TONE M

Function: sets the tone coding and/or decoding mode.

Available values: OFF / ENC / ENC.DEC / DCS

Default value: OFF

ENC: CTCSS coding.

ENC.DEC: CTCSS coding and decoding.

DCS: DCS coding and decoding.

32.- Time Out Timer - TOT

Function: sets the time limit of a continuous transmission.

Available values: OFF / 1... 30 min

Default value: 6 min

33.- TALKAR

Function: switches to simplex working mode when the radio is out of repeater range or when the repeater is not active.

Available values: ON / OFF

Default value: OFF

34.- WID.NAR

Function: sets the bandwidth to reduce the microphone gain (and the deviation).

Available values: WIDE / MID / NARROW

Default value: WIDE

Note: the bandwidth can be independently set for both left and right bands.

35.- Cross-band repeater - X-RPT

Function: enables or disables the cross-band repeater mode.

36.- AM

Function: enables or disables the AM mode.

Available values: ON / OFF

Default value: OFF

37.- AUT.AM

Function: enables or disables the AM automatic mode.

Available values: AUTO / OFF

Default value: AUTO

38.- 2 TONE

Function: sets the 2tones auto-dialling to the memory channel.

Available values: 2T-01 ... 2T-16

Default value: 2T-01

39.- 5 TONE

Function: sets the 5tones auto-dialling to the memory channel.

Available values: 5T-01 ... 5T-16

Default value: 5T-01

40.- SCR

Function: enables or disables the encryption function.

Available values: ON / OFF / 1 a 8

Default value: OFF

41.- COMP

Function: enables or disables the voice compander function.

Available values: ON / OFF

Default value: OFF

42.- HSD.TYP

Function: sets the 2 TONE / 5 TONE / DTMF silencing.

Available values: OFF / 2 TONE / 5 TONE / DTMF

Default value: OFF

Reset procedure

Procedure

Power off the radio.

Keep pressed the left [LOW] key at the same time you power on the radio.

Turn the main control to select the wished option:

F-1 SETMOD RESET: restores the menu settings to factory defaults.

F-2 HYPER RESET: deletes the hyper memories settings to factory defaults.

F-3 MEMORY RESET: deletes the memory channels settings to factory defaults.

F-4 ALL RESET: deletes the memory and other settings to factory defaults.

Once you have chosen the option, short-press the **SET** key to complete the restore procedure.

Troubleshooting guide

Problem	Possible cause and possible solution
The display does not show anything.	The positive and negative polarities are changed. Connect the red cable to the positive terminal, and the black cable to the negative terminal of the power supply.
The fuse has blown.	Check and solve the causing problem and replace it by a new one.
The display is dark.	The screen brightness level has been set too low, set it with a higher value.
There's no sound from the speaker.	The squelch is silenced. Decrease the squelch level. Some CTCSS / DCS and DTMF / 2-tones / 5-tones are active. Disable them.
The buttons and the main control do not work.	The keyboard lock function is enabled. Disable this function.
Can not transmit when pressing the PTT button.	The microphone or antenna connections are poor. Connect them properly.

Technical specifications

General	LUTHOR TECHNOLOGIES
Reference	TLM - 808
Frequency range	Dualband: TX: 144-146 MHz / 430-440 MHz AM/FM RX: 108-180 MHz / 350-512 MHz
Memory channels	809 channels
Frequency steps	2.5/5/6.25/7.5/8.33/10/12.5/15/20/25/50/100 Khz
Emission mode	F3
Antenna impedance	50 Ω
Frequency stability	± 5 ppm @ -140°F~+140°F [-10°C~+60°C]
Working temperature	-4° F~+140°F [- 20°C ~ + 60°C]
Operating voltage	DC 13,8V
Power consumption	RX: 0,5A (Squelch) TX: 8,5A
Dimensions	140mm x 41,5mm x 168mm
Weight	1000g

Transmitter

Output power	50 / 20 / 10 / 5 W (144 MHz) 40 / 20 / 10 / 5 W (430 MHz)
Maximum deviation	< -60 dB (29 MHz: < -50 dB)
Modulation distortion	< 3%
Microphone impedance	2 k Ω

Receiver

Sensitivity (12 dB Sinad)	<0,2 μ V
Squelch sensitivity	<0,16 μ V
Selectivity	12 KHz / 30 KHz
Audio output power	2 W @ 8 Ω para un 5% THD
Type of circuit	Double conversion superheterodyne
Output AF impedance	4-6 Ω

ATTENTION: Some of these specifications can be subject to modification without previous notice.

We have done everything possible to obtain the maximum of detail in this manual, but we are not responsible for any possible omission as well as printing or translation mistakes.

All the specifications are subject to change by LUTHOR TECHNOLOGIES without previous notice.

Note on environmental protection



This symbol on the equipment or its packaging indicates that at the end of the useful life of this product the user is legally obligated to fulfil the European Directive 2012/19/EU, on 4 July 2012 (in the legislative Spanish system RD 110/2015 on 20 February 2015), on Waste Electrical and Electronic Equipment, which applies the following: the electrical and electronic equipment, as well as batteries and rechargeable batteries, can not be treated as normal household waste, but must be delivered to the corresponding collection point.

By ensuring that this product is rejected correctly, you help with this action to prevent negative consequences for the environment and human health which could be caused by its inappropriate management. The recycling of materials helps to preserve natural resources.

To receive detailed information about the recycling of this product, please contact the city office, the most nearby waste disposal service or the establishment where you purchased the product.

Declaration of conformity

CE 0700 

FR

The undersigned, in representation of:

Company: GENEREUS S.L.
Address: Industria 5, nave 8
08160 Montmeló – Barcelona (Spain)
Telephone number: (+34) 93 599 17 65
VAT number: B66339029
E-mail address: gestiontecnica@generheus.com

We declare under our sole responsibility the conformity of the following product:

Type of equipment: Dual band mobile transceiver VHF/UHF
Brand name: LUTHOR TECHNOLOGIES
Model number: TLM-808
Manufacturer: GENEREUS S.L.
Manufacturing site: China

Which it refers this declaration, with the following rules or other policy documents:

- EN 60950-1:2006+A11:2009+A1: Safety regarding information technology equipments. General requirements.
2010+A12:2011+A2:2013
- EN 62311:2008 Assessment of electronic and electrical equipment related to human exposure restrictions for electromagnetic fields (0Hz – 300GHz).
- EN 301 489-1 V1.9.2 / EN 301 489-15 V 1.2.1 Electromagnetic compatibility and Radio spectrum Matters (ERM); ElectroMagnetic Compatibility (EMC) standard for radio equipment and

services; Part 1: Common technical requirements; Part 5: Specific conditions for Private land Mobile Radio (PMR) and ancillary equipment (speech and non-speech).

- EN 301 783-1 V1.2.1 /
EN 301 783-2 V1.2.1

Electromagnetic compatibility and Radio spectrum Matters (ERM); Land Mobile Service; for amateur radio equipments, part 1: technical features and measurement methods; part 2: Harmonized EN covering the essential requirements of article 3.2 of the R&TTE Directive.

- RoHS Directive: 2011/65/UE

About restrictions of the use of certain hazardous substances in electrical and electronic equipment (EEE)..

In accordance with the requirements of Directive 2014/53/UE, of the European Parliament and the 16th April 2014 Council, transposed into Spanish law by Royal Decree 188/2016 of 6th May 2016. More additional information related with the equipment, accessories, images, updated management software, etc. are available on the official website: www.luthortechnologies.com

Montmeló, 15th November 2016



Josefa Paredes Martínez
Manager

Notes

luthortechnologies.com

“LIFE IS GOOD
COMMUNICATION”

luthortechnologies.com

Importador/Imported by
Importé par
Genereus S.L.
ES B66339029