

INTRODUCTION

This manual contains the information you need to build your kit. The **cub** is unique because it uses both surface-mount (SMD) and conventional electronic components. From an electrical standpoint, surface-mount circuitry has many advantages. However, SMD parts are too tiny for most people to handle in a kit. MFJ solves this problem by pre-installing many of the kit's parts using our automated SMD assembly equipment. These machines accomplish--in a matter of minutes--what would take a trained assembler an entire day to complete by hand. Then, once the SMD work is complete, we hand the project over to you.

You'll begin by inventorying the parts packages to ensure everything you need is included. Parts are grouped into two categories. Some are generic components such as switches, jacks, controls, trimmers, and the PA transistor. The rest are frequency-determining coils, capacitors, and crystals that determine the band of operation. To complete your **cub**, you'll need only conventional bench tools and general knowledge of through-hole pc-construction methods. To help you along, this manual provides step-by-step guidance for each operation. When construction is complete, it walks you inspection, testing, and tuning. Finally, it shows you how to install the case and add the finishing touches. In a few short hours, you'll be taking to the airwaves with your new radio.

BEFORE YOU START BUILDING

Work Area: You'll need a clean, smooth, and well-lighted area--a place where you can handle small parts without losing them. A sheet of white poster board makes a good construction surface. Well-diffused overhead lighting and a supplemental high-intensity desk lamp provide strong lighting for close-up work. Be sure to keep the work area free of clutter and discarded wire ends.

Tools and Supplies: Here's a checklist of the tools and supplies you'll need:

- Low-wattage soldering iron with a narrow chisel tip or conical tip.
- Soldering iron holder with a moistened cleaning sponge.
- 60/40 or 63/37 alloy solder .02"-.032" in diameter, rosin or "no-clean" flux.
- Small needle-nose pliers or a surgical hemostat.
- Diagonal or "nippy" wire cutters.
- Solder sucker or desoldering braid.
- Magnifying glass.

These items are needed for testing and tune-up:

- QRP-type RF power meter or VSWR bridge (or 5mm LED, any color).
- 50 ohm dummy load (or two 1 watt 100 ohm carbon-film resistors).
- Telegraph key or keyer with 3.5mm plug installed.
- 8-40 ohm headphones or extension speaker with 3.5mm *stereo* plug installed.
- 13.8V @ 400 mA regulated DC power source.
- Low VSWR antenna cut for your radio's band of operation.
- Low level signal source tuned to the radio's band of operation.
- Kit of insulated tuning tools.

Avoiding Errors: Experience shows there are *four common mistakes* builders make. Avoid these, and your kit should work on the first try!

- 1. Installing Wrong Part:** Pre-sort components before you begin and double-check the numbers stamped on each part before installing.
- 2. Reversing Polarized or Keyed Parts:** ICs, transistors, diodes, and electrolytic capacitors must be installed only one way. Always double-check before inserting!
- 3. Bad Solder Connections:** Constantly inspect for cold solder joints or solder bridges between pads while you work.
- 4. Omitting a Part:** Check off each step in the manual as you complete it.

Soldering Tips: *Cleanliness* and *good heat distribution* are the secrets of professional soldering. Before you install each part, inspect leads for oxidation. If the surface looks dull, burnish it with a pencil eraser or glass-fiber brush (available at Radio Shack). When soldering, let the iron tip contact both lead and pad for about one second before feeding solder. Solder should flow smoothly into platethrough holes, wetting all exposed surfaces. Apply solder sparingly and avoid touching solder wire directly to the hot iron tip.

Desoldering Tips: If you make a mistake and need to remove a part, grasp the component lead with hemostats and heat the pad from the opposite side. Pull gently--the lead should come out (repeat for the other lead). If solder fills in behind, reheat the pad and extract it with a solder-sucker or solder wick. Parts damaged during extraction should be replaced (multilayer capacitors are especially vulnerable to removal damage).

PARTS INVENTORY

After opening you MFJ *cub* box, check for the following.

- 1 - Printed circuit board (surface mount parts installed) P/N: 40-9300-1SM
- 1 - 2.1mm power plug with cable P/N: 620-8321
- 1 - Metal chassis P/N: 800-9300
- 1 - Metal top P/N: 804-9300
- 1 - Construction manual P/N: 925-9300-1
- 1 - Operation manual P/N: 925-9300-2
- 3 - Parts bag

The parts list (bagged parts) is presented in three parts. First, you'll identify and inventory *generic* parts--items common to all *cub* transceivers. Next, you'll inventory *frequency-determining* parts--those items that determine band coverage. Then, you'll inventory the parts for installing and putting the final touches on your enclosure. Identify each part carefully, consulting the manual for color codes or special markings. When sorting capacitors, look for a value or number code printed on the body:

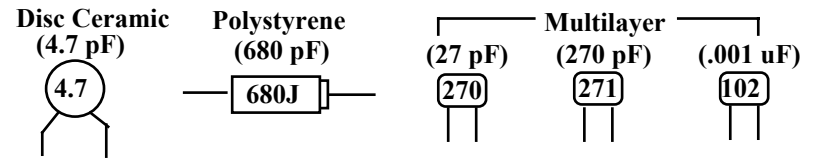

Use the following inventory list to arrange parts for rapid identification during construction. If you discover a missing or damaged item, refer to the warranty section for replacement instructions. Begin by unpacking the kit's *generic* parts.

MFJ-93xxK GENERIC PARTS BAG				
<input checked="" type="checkbox"/>	Qty	Part Description	Designation	MFJ P/N
<input type="checkbox"/>	1	1K 6mm trimpot	R19	135-3100

<input type="checkbox"/>	1	500 ohm 16mm potentiometer	R14	153-2500-1
<input type="checkbox"/>	1	10K 16mm potentiometer	R4	153-4100-1
<input type="checkbox"/>	2	60 pF trimcap	C27,C40	280-0050
<input type="checkbox"/>	1	2N5109 transistor	Q7	305-5109
<input type="checkbox"/>	1	MV2104 varactor	D2	340-2104
<input type="checkbox"/>	1	Red LED (3mm)	CR1	351-3002
<input type="checkbox"/>	1	3.5 uH slug-tuned VFO coil	L3	402-2709S
<input type="checkbox"/>	1	2P2T push-button switch	SW1	504-2022
<input type="checkbox"/>	1	RCA jack	J3	600-0011
<input type="checkbox"/>	2	3.5mm stereo jack	J2, J4	601-5005
<input type="checkbox"/>	1	2.1mm coaxial power jack	J1	601-6021
<input type="checkbox"/>	1	TO-5 heat sink	for Q7	750-0194
<input type="checkbox"/>	1	Print circuit board		862-9320

Next, find the band-determining parts and check contents against the appropriate parts list:

MFJ-9315K SPECIFIC PARTS BAG				
<input checked="" type="checkbox"/>	Qty	Part Description	Designation	MFJ P/N
<input type="checkbox"/>	2	3.3 pF disc ceramic	C13,C46	200-00033-1
<input type="checkbox"/>	2	10 pF multilayer capacitor	C9,C44	220-0010
<input type="checkbox"/>	1	18 pF multilayer capacitor	C48	220-0018
<input type="checkbox"/>	2	47 pF multilayer capacitor	C45,C47	220-0047
<input type="checkbox"/>	1	68 pF multilayer capacitor	C14	220-0068
<input type="checkbox"/>	1	82 pF multilayer capacitor	C52	220-0082
<input type="checkbox"/>	2	100 pF multilayer capacitor	C11,C12	220-0100
<input type="checkbox"/>	5	150 pF multilayer capacitor	C6,C53,C55,C56, C57	220-0150
<input type="checkbox"/>	1	470 pF multilayer capacitor	C15	220-0470
<input type="checkbox"/>	1	330 pF polystyrene capacitor	C7	240-0330
<input type="checkbox"/>	2	1.5 uH molded inductor	L8,L9	401-3150
<input type="checkbox"/>	4	1.2 uH slug-tuned coil	L1,L2,L6,L7	402-3401
<input type="checkbox"/>	2	T37-6 toroid form	for L10,L11	403-1437
<input type="checkbox"/>	5	12 MHz crystal	Y1,Y2,Y3,Y4,Y5	405-0066
<input type="checkbox"/>	1	#22 enamel wire, 24" length	for L10,L11	870-3022R

MFJ-9317K SPECIFIC PARTS BAG				
<input checked="" type="checkbox"/>	Qty	Part Description	Designation	MFJ P/N
<input type="checkbox"/>	2	3.3 pF disc ceramic	C13,C46	200-00033-1

<input type="checkbox"/>	1	10 pF multilayer capacitor	C9	220-0010
<input type="checkbox"/>	1	15 pF multilayer capacitor	C44	220-0015
<input type="checkbox"/>	1	22 pF multilayer capacitor	C48	220-0022
<input type="checkbox"/>	2	56 pF multilayer capacitor	C45,C47	220-0056
<input type="checkbox"/>	1	82 pF multilayer capacitor	C14	220-0082
<input type="checkbox"/>	2	100 pF multilayer capacitor	C11,C12	220-0100
<input type="checkbox"/>	1	150 pF multilayer capacitor	C6	220-0150
<input type="checkbox"/>	4	180 pF multilayer capacitor	C53,C55,C56,C57	220-0180
<input type="checkbox"/>	1	270 pF multilayer capacitor	C52	220-0270
<input type="checkbox"/>	1	560 pF multilayer capacitor	C15	220-0560
<input type="checkbox"/>	1	470 pF polystyrene capacitor	C7	240-0470
<input type="checkbox"/>	2	1.5 uH molded inductor	L8,L9	401-3150
<input type="checkbox"/>	4	1.2 uH slug-tuned coil	L1,L2,L6,L7	402-3401
<input type="checkbox"/>	2	T37-6 toroid form	for L10,L11	403-1437
<input type="checkbox"/>	5	10 MHz crystal	Y1,Y2,Y3,Y4,Y5	405-0065
<input type="checkbox"/>	1	#22 enamel wire, 24" length	for L10,L11	870-3022R

MFJ-9320K SPECIFIC PARTS BAG

<input checked="" type="checkbox"/>	Qty	Part Description	Designation	MFJ P/N
<input type="checkbox"/>	2	3.3 pF disc ceramic	C13,C46	200-00033-1
<input type="checkbox"/>	2	15 pF multilayer capacitor	C44,C48	220-0015
<input type="checkbox"/>	2	68 pF multilayer capacitor	C45,C47	220-0068
<input type="checkbox"/>	1	100 pF multilayer capacitor	C14	220-0100
<input type="checkbox"/>	2	150 pF multilayer capacitor	C11,C12	220-0150
<input type="checkbox"/>	4	220 pF multilayer capacitor	C53,C55,C56,C57	220-0220
<input type="checkbox"/>	2	330 pF multilayer capacitor	C9,C52	220-0330
<input type="checkbox"/>	1	680 pF multilayer capacitor	C15	220-0680
<input type="checkbox"/>	2	680 pF polystyrene capacitor	C6,C7	240-0680
<input type="checkbox"/>	2	1.8 uH molded inductor	L8,L9	401-3180
<input type="checkbox"/>	4	1.5 uH slug-tuned coil	L1,L2,L6,L7	402-3402
<input type="checkbox"/>	2	T37-2 toroid form	for L10,L11	403-1037
<input type="checkbox"/>	5	10 MHz crystal	Y1,Y2,Y3,Y4,Y5	405-0065
<input type="checkbox"/>	1	#22 enamel wire, 24" length	for L10,L11	870-3022R

MFJ-9330K SPECIFIC PARTS BAG

<input checked="" type="checkbox"/>	Qty	Part Description	Designation	MFJ P/N
<input type="checkbox"/>	2	3.3 pF disc ceramic	C13,C46	200-00033-1
<input type="checkbox"/>	1	12 pF multilayer capacitor	C44	220-0012

<input type="checkbox"/>	1	22 pF multilayer capacitor	C9	220-0022
<input type="checkbox"/>	1	27 pF multilayer capacitor	C48	220-0027
<input type="checkbox"/>	2	82 pF multilayer capacitor	<i>add-ons</i>	220-0056
<input type="checkbox"/>	2	100 pF multilayer capacitor	C45,C47	220-0100
<input type="checkbox"/>	1	120 pF multilayer capacitor	C14	220-0120
<input type="checkbox"/>	2	220 pF multilayer capacitor	C11,C12	220-0220
<input type="checkbox"/>	5	330 pF multilayer capacitor	C52,C53,C55,C56 C57	220-0330
<input type="checkbox"/>	1	680 pF multilayer capacitor	C15	220-0680
<input type="checkbox"/>	1	560 pF polystyrene capacitor	C6	240-0560
<input type="checkbox"/>	1	680 pF polystyrene capacitor	C7	240-0680
<input type="checkbox"/>	2	2.7 uH molded inductor	L8,L9	401-3270
<input type="checkbox"/>	4	2.4 uH slug-tuned coil	L1,L2,L6,L7	402-3403S
<input type="checkbox"/>	2	T37-2 toroid form	<i>for</i> L10,L11	403-1037
<input type="checkbox"/>	5	6 MHz crystal	Y1,Y2,Y3,Y4,Y5	405-0055
<input type="checkbox"/>	1	#24 enamel wire, 36" length	<i>for</i> L10,L11	870-3024R

MFJ-9340K SPECIFIC PARTS BAG

<input checked="" type="checkbox"/>	Qty	Part Description	Designation	MFJ P/N
<input type="checkbox"/>	2	6.8 pF disc ceramic	C13,C46	200-00068
<input type="checkbox"/>	2	27 pF multilayer capacitor	C44,C48	220-0027
<input type="checkbox"/>	1	68 pF multilayer capacitor	C9	220-0068
<input type="checkbox"/>	2	120 pF multilayer capacitor	C45,C47	220-0120
<input type="checkbox"/>	1	180 pF multilayer capacitor	C14	220-0180
<input type="checkbox"/>	2	270 pF multilayer capacitor	C11,C12	220-0270
<input type="checkbox"/>	4	470 pF multilayer capacitor	C53,C55,C56,C57	220-0470
<input type="checkbox"/>	2	560 pF multilayer capacitor	C52,C62	220-0220
<input type="checkbox"/>	1	820 pF multilayer capacitor	C15	220-0820
<input type="checkbox"/>	1	470 pF polystyrene capacitor	C6	240-0470
<input type="checkbox"/>	1	680 pF polystyrene capacitor	C7	240-0680
<input type="checkbox"/>	1	3.3 uH molded inductor	L8	401-3330
<input type="checkbox"/>	1	4.7 uH molded inductor	L9	401-3470
<input type="checkbox"/>	4	3.5 uH slug-tuned coil	L1,L2,L6,L7	402-2709S
<input type="checkbox"/>	2	T37-2 toroid form	<i>for</i> L10,L11	403-1037
<input type="checkbox"/>	5	12 MHz crystal	Y1,Y2,Y3,Y4,Y5	405-0066
<input type="checkbox"/>	1	#24 enamel wire, 36" length	<i>for</i> L10,L11	870-3024R

MFJ-9380K SPECIFIC PARTS BAG

<input checked="" type="checkbox"/>	Qty	Part Description	Designation	MFJ P/N
<input type="checkbox"/>	2	12 pF multilayer capacitor	C13,C46	220-0012
<input type="checkbox"/>	1	27 pF multilayer capacitor	C9	220-0027
<input type="checkbox"/>	2	47 pF multilayer capacitor	C44,C48	220-0047

<input type="checkbox"/>	3	270 pF multilayer capacitor	C6,C45,C47	220-0270
<input type="checkbox"/>	2	330 pF multilayer capacitor	C14,C52	220-0330
<input type="checkbox"/>	2	560 pF multilayer capacitor	C11,C12	220-0560
<input type="checkbox"/>	3	820 pF multilayer capacitor	C55,C56,C57	220-0820
<input type="checkbox"/>	1	.001 uF multilayer capacitor	C53	220-1100
<input type="checkbox"/>	1	.0022 uF multilayer capacitor	C15	220-1220
<input type="checkbox"/>	1	680 pF polystyrene capacitor	C7	240-0680
<input type="checkbox"/>	2	8.2 uH molded inductor	L8,L9	401-3820
<input type="checkbox"/>	4	6.8 uH slug-tuned coil	L1,L2,L6,L7	402-3406
<input type="checkbox"/>	2	T37-2 toroid form	for L10,L11	403-1037
<input type="checkbox"/>	5	10 MHz crystal	Y1,Y2,Y3,Y4,Y5	405-0065
<input type="checkbox"/>	1	#24 enamel wire, 36" length	for L10,L11	870-3024R

MFJ-93xxK HARDWARE BAG

<input checked="" type="checkbox"/>	Qty	Part Description	MFJ P/N
<input type="checkbox"/>	2	4-40 x 1/2" screw	654-0500
<input type="checkbox"/>	2	Self-tapping screw (black)	656S-0375B-A
<input type="checkbox"/>	2	4-40 x 1/4" hex spacer	716B-0250
<input type="checkbox"/>	2	4-40 KEP nuts	705-0440-K
<input type="checkbox"/>	1	1/2" x 3/4" knob	760-0023
<input type="checkbox"/>	1	1" x 3/4" knob	760-0035
<input type="checkbox"/>	1	Red push-button cap	760-2042
<input type="checkbox"/>	4	Rubber feet	770-1162
<input type="checkbox"/>	2	Panel nut for 16mm pot	705-7075
<input type="checkbox"/>	2	Panel washer for 16mm pot	710-2550

PARTS PLACEMENT DIAGRAM

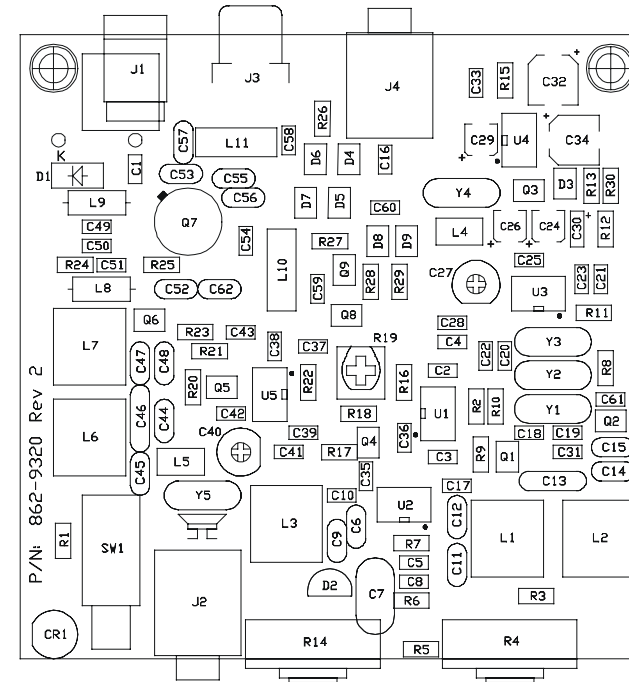

STEP-BY-STEP ASSEMBLY

Terminology: When you read the term *install*, this means to locate, identify, dress the leads, and insert the part into its mounting holes on the PC board. Once a component is mounted, bend each lead over and use sharp side-cutters to clip off the excess. Make sure lead ends don't touch other pads, tracks, or the groundplane surface (see below).

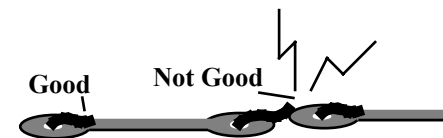

The term *solder* means to solder the part's leads in place, inspect for flaws or solder bridges, and nip off any protruding lead or pin with a sharp pair of side cutters. All solder connections will be made on the bottom (groundplane) side of the pc board.

Generic Parts--All Models: Begin by installing the generic parts. If you have difficulty reading markings screened on the pc board, refer to the Parts Placement diagram. If possible, make a copy of it to post in your work area.

Generic Parts

Begin by finding two (2) 3.5mm stereo phone jacks. When installing, make sure the plastic body is seated flush with the pc board.

- Install a 3.5mm phone jack at J2 and solder all 5 pins.
- Install a 3.5mm phone jack at J4 and solder all pins.
- Locate the 2.1mm coaxial power jack. Install at J1 and twist all tabs 45 degrees with pliers to secure in place. Solder all 3 tabs.
- Locate the RCA antenna jack. Seat firmly at J3 and solder all 4 tabs.
- Install the 2P2T mini power switch at SW1 and solder all 6 pins.
This may be a tight fit – work pins in slowly.

Find two potentiometers (volume and tune), and use the detail below when installing:

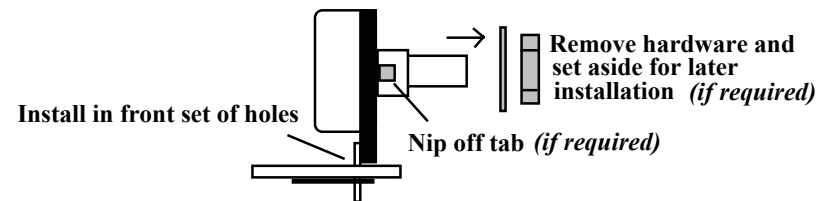

- Identify the 500 ohm pot (B500). Install at R14 and solder all 3 tabs.
- Identify the 10K pot (B10K). Install at R4 and solder all 3 tabs.

Find two (2) 60 pF MuRata trimcaps (orange plastic body).

- Install a 60 pF trimcap at C27 (flat side either way) and solder.
- Install a 60 pF trimcap at C40 (flat side either way) and solder.

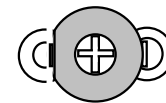

- Locate the 10K 6mm trimpot (marked 102). Install at R19 and solder all 3 tabs.

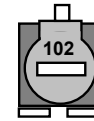

- Locate the red LED. Following the detail provided below, mount at CR1. Note that CR1 is a polarized part. Orient so the *shorter* of the two leads (cathode) is toward the corner of the board (ground). When positioned as shown, solder.

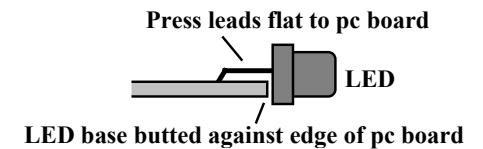
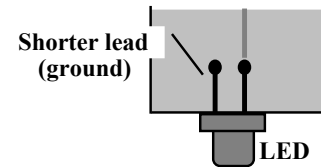

- Locate the MV2104 varactor diode (looks like a plastic transistor with two leads). Install at D2 with the flat side toward the front of the pc board. Solder.

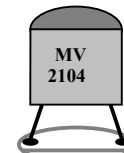

- Locate the 3.5 uH shielded slug-tuned VFO coil. Inspect to make sure all pins and tabs are straight. Install at L3 and solder all pins and tabs.

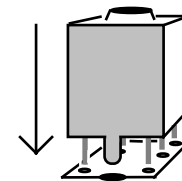

Locate the 2N5109 PA transistor. The *cub* normally delivers 1.5 - 2.0 watts RF output from a 13.8V power source using this device (1 watt on 15 meters). If you wish to substitute a more powerful PA transistor, check the supplemental instructions following this step. If not, inspect the 2N5109 and straighten any bent leads.

- Install Q7 so its flange is elevated about .1" above the pc board, as shown. Solder in place. The clip-on heatsink will be installed later, after the remaining parts are mounted.

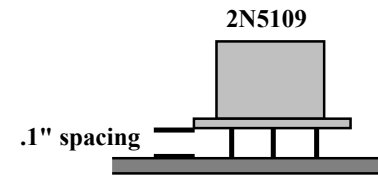

Alternative PA Transistors: A 2N3553 (*not supplied*) may be substituted directly for the 2N5109. This device typically delivers up to 50% more output. A second substitute, the Motorola MRF-237, may deliver even more output--up to 4 watts on 20 meters. *The MRF-237 is not a direct replacement.* When installing, the case must be rotated 180-degrees and its base lead brought across to the base-connection pad (see below). Note that MFJ cannot accept responsibility for the outcome of any customer modification.



This concludes installation of the generic parts provided in your kit. Take a break and double-check your work before beginning installation of the frequency-determining parts.

Band-Determining Parts: Locate the frequency-determining parts that go with your kit. Now, select the assembly instructions that apply to your particular radio:

MFJ-9315 15 Meter Transceiver

Locate two (2) 3.3 pF disc ceramic capacitors marked 339 or 3.3.

- Install a 3.3 pF capacitor at C13 and solder.
- Install a 3.3 pF capacitor at C46 and solder.

The next group of capacitors you'll install are multilayer. Forcing or overheating the leads of multilayer caps may damage them, so use care during

installation or removal. If necessary, pre-shape leads to the correct spacing before inserting.

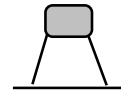
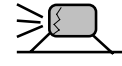
**Incorrect****Incorrect****Correct**

Find two (2) 10 pF multilayer caps (marked 10 or 100).

- Install 10 pF at C9 and solder.
- Install 10 pF at C44 and solder.
- Locate a 18 pF multilayer cap (marked 18 or 180). Install at C48 and solder.

Find two (2) 47 pF multilayer caps (47 or 470).

- Install 47 pF at C45 and solder.
- Install 47 pF at C47 and solder.
- Locate a 68 pF multilayer cap (68 or 680). Install at C14 and solder.
- Locate a 82 pF multilayer cap (82 or 820). Install at C52 and solder.

Find two (2) 100 pF multilayer caps (101).

- Install 100 pF at C11 and solder.
- Install 100 pF at C12 and solder.

Find five (5) 150 pF multilayer caps (151).

- Install 150 pF at C6 and solder.
- Install 150 pF at C53 and solder.
- Install 150 pF at C55 and solder.
- Install 150 pF at C56 and solder.
- Install 150 pF at C57 and solder.

Locate a 470 pF multilayer cap. Install at C15 and solder.

- Locate a 330 pF polystyrene capacitor (silver in color, 330J stamped on the body). Install at C7 and solder in place.

This completes capacitor installation (*C62 is not used with the 15 meter kit*).

Find four (4) shielded slug-tuned coils (1.2 uH). Inspect each coil and straighten bent soldering tabs or pins.

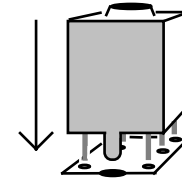

- Install a shielded coil at L1. Soldering all five (5) pins and both tabs.
- Install a shielded coil at L2 and solder.
- Install a shielded coil at L6 and solder.
- Install a shielded coil at L7 and solder.

Find two (2) 1.5 uH molded chokes (brown-green-gold-silver).

- Install a 1.5 uH choke at L8.
- Install a 1.5 uH choke at L9.

Find two (2) T37-6 toroid forms (doughnut-shaped, .37" in diameter, black with yellow-paint color coding). Also, find the length of #22 enameled wire and cut into two equal lengths. L10 and L11 are hand-wound on toroid forms prior to installation. When winding toroids, remember *the number of turns are counted inside the form*. Pull each turn up tight before starting the next. If the coil is wound loosely, inductance may be too high, compromising transmitter performance. After winding, scrape both leads with a hobby knife to remove insulation and tin with solder.

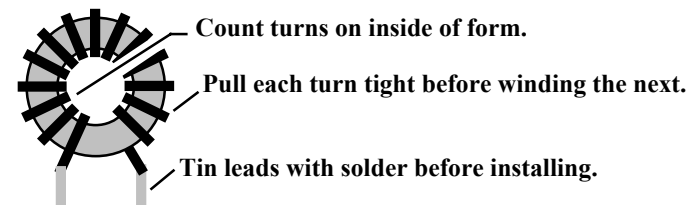

- Wind 10 turns of #22 enameled wire onto a T37-6 toroid form and prep leads.
- Install at L10 and solder.
- Wind 10 turns of #22 on the second T37-6 toroid form and prep.
- Install at L11 and solder.

Next, find the five (5) 12 MHz crystals (12.000). When installing, do not press the can tightly against the pc board--this could short mounting pads to the metal case. Leave a small air-gap between the base and pc board.

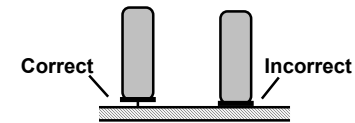

- Install a 12 MHz crystal at Y1.
- Install a 12 MHz crystal at Y2.
- Install a 12 MHz crystal at Y3.
- Install a 12 MHz crystal at Y4.
- Install a 12 MHz crystal at Y5.

This concludes assembly of the MFJ-9315 board. Proceed to the Testing and Alignment section.

MFJ-9317 17 Meter Transceiver

Locate two (2) 3.3 pF disc ceramic capacitors marked 339 or 3.3.

- Install a 3.3 pF capacitor at C13 and solder.
- Install a 3.3 pF capacitor at C46 and solder.

The next group of capacitors you'll install are multilayer. Forcing or overheating the leads of multilayer caps may damage them, so use care during installation or removal. If necessary, pre-shape leads to the correct spacing before inserting.

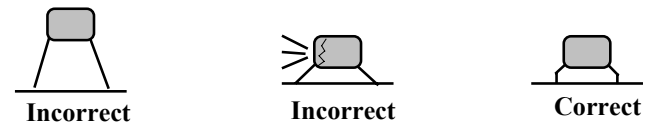

- Locate a 10 pF multilayer cap (marked 10 or 100). Install at C9 and solder.
- Locate a 15 pF multilayer cap (marked 15 or 150). Install at C44 and solder.
- Locate a 22 pF multilayer cap (marked 22 or 220). Install at C48 and solder.

Find two (2) 56 pF multilayer caps (56 or 560).

- Install 56 pF at C45 and solder.
- Install 56 pF at C47 and solder.
- Locate a 82 pF multilayer cap (82 or 820). Install at C14 and solder.

Find two (2) 100 pF multilayer caps (101).

- Install 100 pF at C11 and solder.
- Install 100 pF at C12 and solder.
- Locate a 150 pF multilayer cap (151). Install at C6 and solder.

Find five (4) 180 pF multilayer caps (181).

- Install 180 pF at C53 and solder.
- Install 180 pF at C55 and solder.
- Install 180 pF at C56 and solder.
- Install 180 pF at C57 and solder.
- Locate a 270 pF multilayer cap (271). Install at C52 and solder.
- Locate a 560 pF multilayer cap (561). Install at C15 and solder.
- Locate a 470 pF polystyrene capacitor (silver in color, 470J stamped on the body). Install at C7 and solder in place.

This completes capacitor installation (*C62 is not used with the 17 meter kit*).

Find four (4) shielded slug-tuned coils (1.2 uH). Examine each coil and straighten soldering tabs or bent pins.

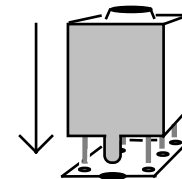

- Install a 1.2 uH shielded coil at L1. Solder all five (5) pins and both tabs.
- Install a 1.2 uH shielded coil at L2 and solder.
- Install a 1.2 uH shielded coil at L6 and solder.
- Install a 1.2 uH shielded coil at L7 and solder.

Find two (2) 1.5 uH molded chokes (brown-green-gold-silver).

- Install a 1.5 uH choke at L8.
- Install a 1.5 uH choke at L9.

Find two (2) T37-6 toroid forms (doughnut-shaped, .37" in diameter, black with yellow-paint color coding). Also, find the length of #22 enameled wire and cut into two equal lengths. L10 and L11 are hand-wound on toroid forms prior to installation. When winding toroids, remember *the number of turns are counted inside the form*. Pull each turn up tight before starting the next. If the coil is wound loosely, inductance may be too high, compromising transmitter performance. After winding, scrape both leads with a hobby knife to remove insulation and tin with solder. Following these instructions:

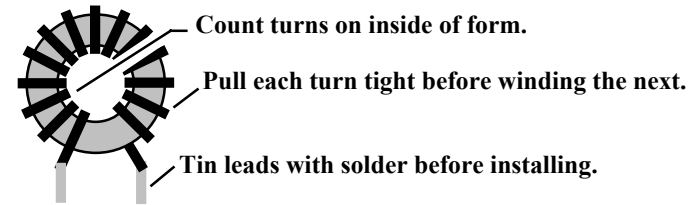

- Wind 11 turns of #22 enameled wire onto a T37-6 toroid form and prep leads.
- Install at L10 and solder.
- Wind 11 turns of #22 on the second T37-6 toroid form and prep leads.
- Install at L11 and solder.

Next, find the five (5) 10 MHz crystals (10.000). When installing crystals, do not press the can tightly against the pc board--this could short mounting pads to the metal case. Leave a small air-gap between the base and pc board.

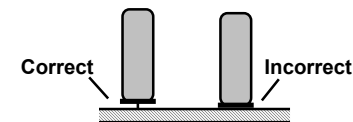

- Install a 10-MHz crystal at Y1.
- Install a 10-MHz crystal at Y2.
- Install a 10-MHz crystal at Y3.
- Install a 10-MHz crystal at Y4.
- Install a 10-MHz crystal at Y5.

This concludes assembly of the MFJ-9317 board. Proceed to the Testing and Alignment section.

MFJ-9320 20 Meter Transceiver

Locate two (2) 3.3 pF disc ceramic capacitors marked 339 or 3.3.

- Install a 3.3 pF capacitor at C13 and solder.
- Install a 3.3 pF capacitor at C46 and solder.

The next group of capacitors you'll install are multilayer. Forcing or overheating the leads of multilayer caps may damage them, so use care during installation or removal. If necessary, pre-shape leads to the correct spacing before inserting.

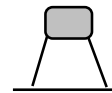

Incorrect

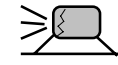

Incorrect



Correct

Find two (2) 15 pF multilayer caps (marked 15 or 150).

- Install 15 pF at C44 and solder.
- Install 15 pF at C48 and solder.

Find two (2) 68 pF multilayer caps (marked 68 or 680).

- Install 68 pF at C45 and solder.
- Install 68 pF at C47 and solder.
- Locate a 100 pF multilayer cap (marked 101). Install at C14 and solder.

Find two (2) 150 pF multilayer caps (marked 151).

- Install 150 pF at C11 and solder.
- Install 150 pF at C12 and solder.

Find four (4) 220 pF multilayer caps (marked 221).

- Install 220 pF at C53 and solder.
- Install 220 pF at C55 and solder.
- Install 220 pF at C56 and solder.
- Install 220 pF at C57 and solder.

Find two (2) 330 pF multilayer caps (marked 331).

- Install 330 pF at C9 and solder).
- Install 330 pF at C52 and solder).
- Locate a 680 pF multilayer cap (marked 681). Install at C15 and solder.

Find two 680 pF polystyrene type capacitor (silver in color, coated with clear plastic, 680J stamped on the body).

- Install 680 pF (polystyrene) at C7 and solder in place.
- Install 680 pF (polystyrene) at C6, standing on end--as illustrated below:

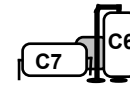

This completes capacitor installation (*C62 is not used with the 20 meter kit*).

Find four (4) 1.5 uH shielded slug-tuned coils. Inspect each and straighten any bent tabs or pins.

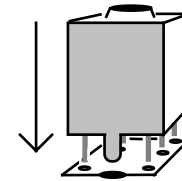

- Install a shielded coil at L1, soldering both tabs and all 5 pins.
- Install a shielded coil at L2, and solder.
- Install a shielded coil at L6 and solder.
- Install a shielded coil at L7 and solder.

Find two (2) 1.8 uH molded chokes (brown-gray-gold-silver).

- Install a 1.8 uH choke at L8 and solder.
- Install a 1.8 uH choke at L9 and solder.

Find two (2) T37-2 toroid forms (doughnut-shaped, .37" in diameter, black with red paint color coding). Also, find the length of #22 enameled wire and cut into two equal lengths. L10 and L11 are hand-wound on toroid forms prior to installation. When winding toroids, remember *the number of turns are counted inside the form*. Pull each turn up tight before starting the next. If the coil is wound loosely, inductance may be too high, compromising transmitter performance. After winding, scrape both leads with a hobby knife to remove insulation and tin with solder.

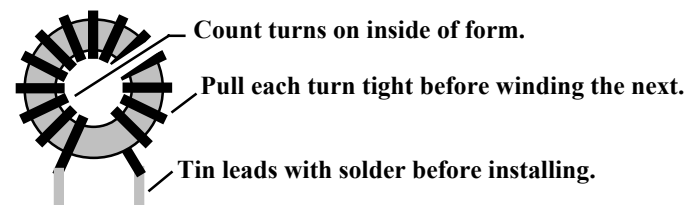

- Wind 12 turns of #22 enameled wire onto a T37-2 toroid form and prep leads.
- Install at L10 and solder.
- Wind 12 turns of #22 on the second T37-2 toroid form and prep leads.
- Install at L11 and solder.

Next, find the five (5) 10 MHz crystals (10.000). When installing crystals, do not press the can tightly against the pc board--this could short mounting pads to the metal case. Leave a small air-gap between the base and pc board.

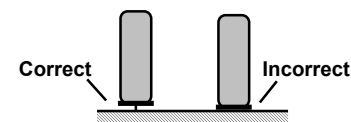

- Install a 10 MHz crystal at Y1.
- Install a 10 MHz crystal at Y2.
- Install a 10 MHz crystal at Y3.
- Install a 10 MHz crystal at Y4.
- Install a 10 MHz crystal at Y5.

This concludes assembly of the MFJ-9320 board. Proceed to the Testing and Alignment section.

MFJ-9330 30 Meter Transceiver

Locate two (2) 3.3 pF disc ceramic capacitors marked 339 or 3.3.

- Install a 3.3 pF capacitor at C13 and solder.
- Install a 3.3 pF capacitor at C46 and solder.

The next group of capacitors you'll install are multilayer. Forcing or overheating the leads of multilayer caps may damage them, so use care during

installation or removal. If necessary, pre-shape leads to the correct spacing before inserting.

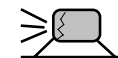
**Incorrect****Incorrect****Correct**

- Locate a 12 pF multilayer cap (12 or 120). Install at C44 and solder.
- Locate a 22 pF multilayer cap (22 or 220). Install at C9 and solder.
- Locate a 27 pF multilayer cap (27 or 270). Install at C48 and solder.

Find two (2) 100 pF multilayer caps (marked 101).

- Install 100 pF at C45 and solder.
- Install 100 pF at C47 and solder.
- Locate a 120 pF multilayer cap (marked 121). Install at C14 and solder.

Find two (2) 220 pF multilayer caps (marked 221).

- Install 220 pF at C11 and solder.
- Install 220 pF at C12 and solder.

Find four (4) 330 pF multilayer caps (marked 331).

- Install 330 pF at C53 and solder.
- Install 330 pF at C55 and solder.
- Install 330 pF at C56 and solder.
- Install 330 pF at C57 and solder.
- Locate a 680 pF multilayer cap (marked 681). Install at C15 and solder.
- Locate a 680 pF polystyrene capacitor (silver in color, 680J stamped on the body). Install at C7 and solder.
- Locate a 560 pF polystyrene capacitor (silver in color, 560J stamped on the body). Install vertically at C6--as illustrated below--and solder:

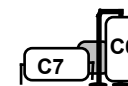

There should be two (2) un-installed 82 pF multilayer caps remaining (82 or 820). These will be installed on the groundplane (bottom) side of the board.

Prepare these caps for installation by trimming the leads back to about .25" (1/4"). Spread the leads slightly and tin with solder.

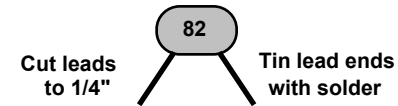

Flip the pc board over and locate the mounting pads for trimcap C27 on the bottom (left side, about mid-way back). Also, locate a "via" (plate-through hole) to the right of C27. The first 82 pF cap will be installed here, as illustrated in the following diagram:

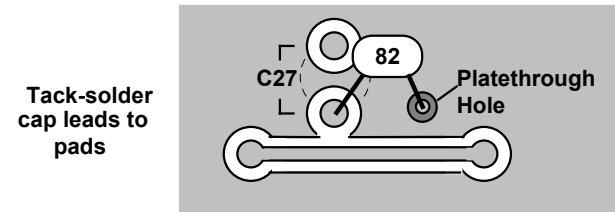

- Tin the platethrough hole with solder.
- Tack-solder a 82 pF multilayer cap between the two pads shown.

Next, locate the mounting pads for trimcap C48 (just behind L3). Also, locate the "via" (or plate-through hole) slightly to the left. The remaining 82 pF cap will be installed here, as shown in the following diagram:

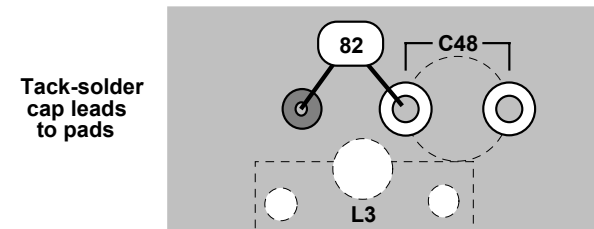

- Tin the platethrough hole with solder.
- Tack-solder a 82 pF multilayer cap between the indicated pads.

This completes capacitor installation (*C62 is not used with the 30 meter kit*).

Find four (4) 2.4 uH shielded slug-tuned coils. Inspect each one and straighten any bent tabs or pins.

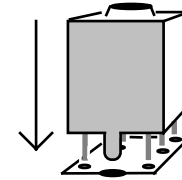

- Install a 2.4 uH coil at L1, soldering both tabs and all five pins.
- Install a 2.4 uH coil at L2 and solder.
- Install a 2.4 uH coil at L6 and solder.
- Install a 2.4 uH coil at L7 and solder.

Find two (2) 2.7 uH molded chokes (red-violet-gold-silver).

- Install a 2.7 uH choke at L8.
- Install a 2.7 uH choke at L9.

Find two (2) T37-2 toroid forms (doughnut-shaped, .37" in diameter, black with red paint color coding). Also, find the length of #24 enameled wire and cut into two equal lengths. L10 and L11 are hand-wound on toroid forms prior to installation. When winding toroids, remember *the number of turns are counted inside the form*. Pull each turn up tight before starting the next. If the coil is wound loosely, inductance may be too high, compromising transmitter performance. After winding, scrape both leads with a hobby knife to remove insulation and tin with solder.

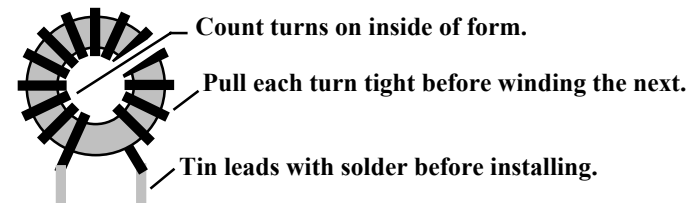

- Wind 16 turns of #24 enameled wire onto a T37-2 toroid form and prep leads.
- Install at L10 and solder.
- Wind 16 turns of #24 on the second T37-2 toroid form and prep leads.
- Install at L11 and solder.

Next, find the five (5) 6 MHz crystals (6.000). When installing crystals, do not press them tightly against the pc board--this could short mounting pads to the metal case. Leave a small air-gap between the base and pc board.

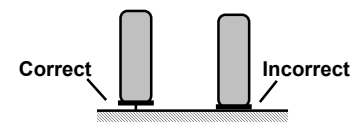

- Install a 6- MHz crystal at Y1.
- Install a 6-MHz crystal at Y2.
- Install a 6-MHz crystal at Y3.
- Install a 6-MHz crystal at Y4.
- Install a 6-MHz crystal at Y5.

This concludes assembly of the MFJ-9330 board. Proceed to the Testing and Alignment section.

MFJ-9340 40-Meter Transceiver

Locate two (2) 6.8 pF disc ceramic capacitors marked 689 or 6.8.

- Install a 6.8 pF capacitor at C13 and solder.
- Install a 6.8 pF capacitor at C46 and solder.

The next group of capacitors you'll install are multilayer. Forcing or overheating the leads of multilayer caps may damage them, so use care during installation or removal. If necessary, pre-shape leads to the correct spacing before inserting.

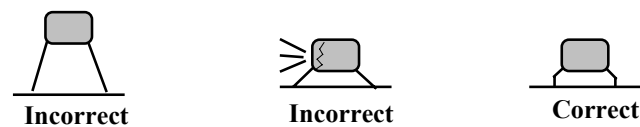

Find two (2) 27 pF multilayer caps (marked 27 or 270).

- Install 27 pF at C44 and solder.
- Install 27 pF at C48 and solder.

Locate a 68 pF multilayer cap (68 or 680). Install at C9 and solder.

Find two (2) 120 pF multilayer caps (marked 121).

- Install 120 pF at C45 and solder.
- Install 120 pF at C47 and solder.

Locate a 180 pF multilayer cap (marked 181). Install at C14 and solder.

Find two (2) 270 pF multilayer caps (marked 271).

Install 270 pF at C11 and solder.

Install 270 pF at C12 and solder.

Find four (4) 470 pF multilayer caps (marked 471).

Install 470 pF at C53 and solder.

Install 470 pF at C55 and solder.

Install 470 pF at C56 and solder.

Install 470 pF at C57 and solder.

Find two (2) 560 pF multilayer caps (marked 561).

Install 560 pF at C52 and solder.

Install 560 pF at C62 and solder.

Locate a 820 pF multilayer cap (marked 821). Install at C15 and solder.

This completes installation of all multilayer capacitors. The remaining two capacitors are polystyrene. Polystyrene caps are used at C6 and C7 to temperature-compensate the VFO for reduced drift.

Locate a 470 pF polystyrene cap (silver--marked 470J). Install, on end, at C6 as shown below:

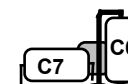

Locate a 680 pF polystyrene cap (silver--marked 680J). Install at C7 and solder.

Find four (4) 3.5 uH shielded slug-tuned coils. Install as shown in the following diagram--soldering all tabs and pins:

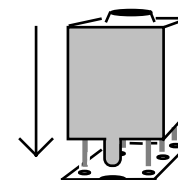

Install 3.5 uH at L1 and solder.

Install 3.5 uH at L2 and solder.

- Install 3.5 uH at L6 and solder.
- Install 3.5 uH at L7 and solder.
- Locate a 3.3 uH molded choke (orange-orange-gold-silver). Install at L8 and solder.
- Locate a 4.7 uH molded choke (yellow-violet-gold-silver). Install at L9 and solder.

Find two (2) T37-2 toroid forms (doughnut-shaped, .37" in diameter, black with red paint color coding). Also, find the length of #24 enameled wire and cut into two equal lengths. L10 and L11 are hand-wound on toroid forms prior to installation. When winding toroids, remember *the number of turns are counted inside the form*. Pull each turn up tight before starting the next. If the coil is wound loosely, inductance may be too high, compromising transmitter performance. After winding, scrape both leads with a hobby knife to remove insulation and tin with solder.

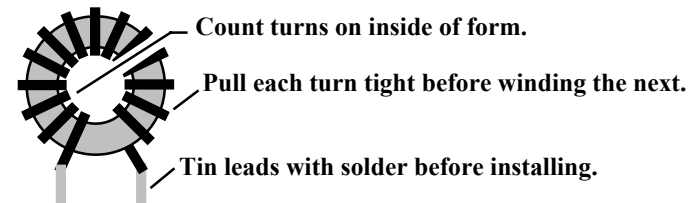

- Wind 18 turns of #24 enameled wire onto a T37-2 toroid form and prep leads.
- Install at L10 and solder.
- Wind 18 turns of #24 on the second T37-2 toroid form and prep leads.
- Install at L11 and solder.

Next, find the five (5) 12 MHz crystals (12.000). When installing crystals, do not press them tightly against the pc board--this could short mounting pads to the metal case. Leave a small air-gap between the base and pc board.

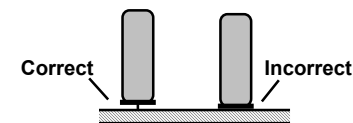

- Install a 12 MHz crystal at Y1.

- Install a 12 MHz crystal at Y2.
- Install a 12 MHz crystal at Y3.
- Install a 12 MHz crystal at Y4.
- Install a 12 MHz crystal at Y5.

This concludes assembly of the MFJ-9340 board. Proceed to the Testing and Alignment section.

MFJ-9380 80 Meter Transceiver

The first group of capacitors you'll install are multilayer. Forcing or overheating the leads of multilayer caps may damage them, so use care during installation or removal. If necessary, pre-shape leads to the correct spacing before inserting.

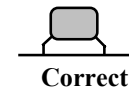
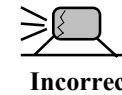
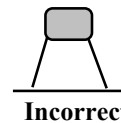

Locate two (2) 12 pF multilayer capacitors marked 12 or 120.

- Install 12 pF at C13 and solder.
- Install 12 pF at C46 and solder.

Find a 27 pF multilayer cap (27 or 270). Install at C9 and solder.

Locate two (2) 47 pF multilayer caps (marked 47 or 470).

- Install 47 pF at C44 and solder.
- Install 47 pF at C48 and solder.

Locate three (3) 270 pF multilayer caps (marked (271).

- Install 270 pF at C6 and solder.
- Install 270 pF at C45 and solder.
- Install 270 pF at C47 and solder.

Locate two (2) 330-pF multilayer cap (331).

- Install 330 pF at C14 and solder.
- Install 330 pF at C52 and solder.

Locate two (2) 560 pF multilayer caps (561).

Install 560 pF at C11 and solder.

Install 560 pF at C12 and solder.

Locate three (3) 820 pF multilayer caps (821).

Install 820 pF at C55 and solder.

Install 820 pF at C56 and solder.

Install 820 pF at C57 and solder.

Find a .001 uF multilayer cap (102). Install at C53 and solder.

Find a .0022 uF multilayer cap (222). Install at C15 and solder.

Locate a 680 pF polystyrene cap (silver--marked 680J). Install at C7 and solder.

This completes capacitor installation (*C62 is not used with the 80 meter kit*).

Next, find four (4) 6.8 uH shielded slug-tuned coils. Install as shown below--soldering all tabs and pins:

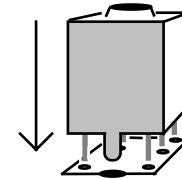

Install 6.8 uH at L1 and solder.

Install 6.8 uH at L2 and solder.

Install 6.8 uH at L6 and solder.

Install 6.8 uH at L7 and solder.

Find two (2) 8.2 uH molded chokes (gray-red-gold-silver).

Install 8.2 uH at L8 and solder.

Install 8.2 uH at L9 and solder.

Find two (2) T37-2 toroid forms (doughnut-shaped, .37" in diameter, black with red paint color coding). Also, find the length of #24 enameled wire and cut into two equal lengths. L10 and L11 are hand-wound on toroid forms prior to installation. When winding toroids, remember *the number of turns are counted inside the form*. Pull each turn up tight before starting the next. If the coil is wound loosely, inductance may be too high, compromising transmitter performance. After winding, scrape both leads with a hobby knife to remove insulation and tin with solder. Following these instructions:

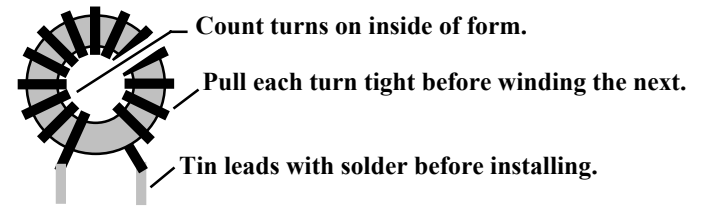

- Wind 24 turns of #24 enameled wire onto a T37-2 toroid form and prep leads.
- Install at L10 and solder.
- Wind 24 turns of #24 on the second T37-2 toroid form and prep leads.
- Install at L11 and solder.

Next, find the five (5) 10 MHz crystals (10.000). When installing crystals, do not press the can tightly against the pc board--this could short mounting pads to the metal case. Leave a small air-gap between the base and pc board.

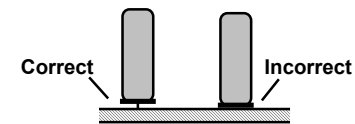

- Install a 10 MHz crystal at Y1.
- Install a 10 MHz crystal at Y2.
- Install a 10 MHz crystal at Y3.
- Install a 10 MHz crystal at Y4.
- Install a 10 MHz crystal at Y5.

This concludes assembly of the MFJ-9380 board. Proceed to the Testing and Alignment section.

TESTING AND ALIGNMENT

PC Board Inspection: Before applying power to your *cub*, give the pc board a thorough inspection:

1. Compare parts locations against the placement diagram. Is each part where it is supposed to be? Is the value correct? Scan the pc board in an organized pattern.

2. Inspect the solder side (bottom) for cold-solder joints and bridges using a magnifying glass. All joints should be smooth and shiny. Resolder any beaded or dull connections.

If a careful inspection reveals everything is OK, you're ready for the moment of truth!

Tools and Materials Required for Testing:

50 ohm dummy load: Use a conventional dummy, or use two (2) 100 ohm 1 watt metal oxide resistors (RadioShack 271-152) connected in parallel across a RCA plug.

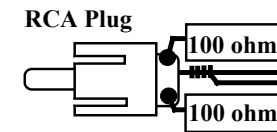

Power Meter: Use a sensitive QRP-type power meter (2W, 5W, or 10W full scale). If unavailable, use a standard 5mm LED as a power indication (see instructions).

Telegraph Key: Use any hand-key with a 3.5mm plug attached. Connect ground (common) to the outer sleeve, and the key line to the tip (ring connection not used).

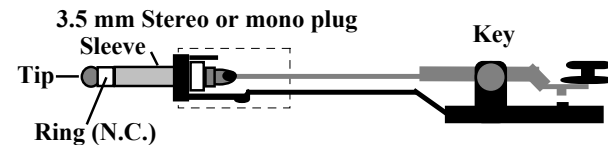

Power Supply: Use any well-regulated 12-14 volt 400 mA DC power source outfitted with a 2.1mm DC plug. Plus (+) connects to the center pin and the minus (-) to the outer sleeve. If using a high-current dc supply, protect both power leads with 1 Amp fuses. See the *cub*'s Operating Manual for additional power-source information.

Test Set-up and Preliminary Check

Set up your *cub* as shown below on a clean non-metallic surface. Before connecting power, confirm that power switch *SW1* is off.

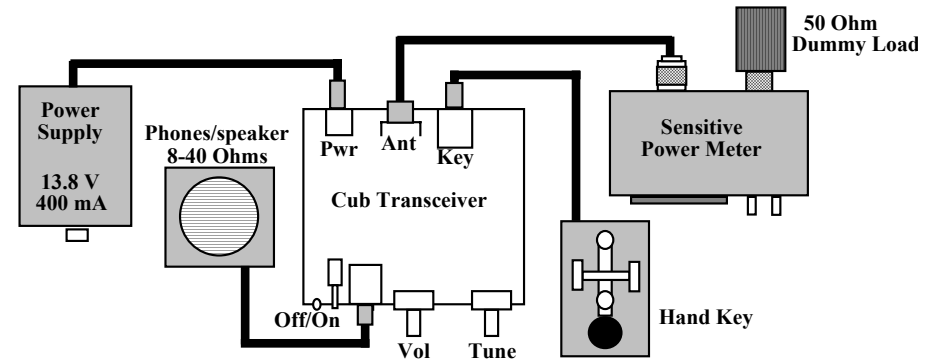

If no RF power meter is available, install a dummy load at the *cub*'s antenna jack and connect a 5mm LED across the antenna terminals (LED polarity not important). This will serve as a relative power indicator.

1. Press the *cub*'s Power switch to *On*. CR1 should light (if it doesn't light, turn power off and check the polarity of your power source).
2. Advance *Volume* (R14) fully clockwise and press the Power switch a couple times. You should hear a "pop" in the test speaker and detect faint background noise.

Tune-Up Controls and their Function

The chart below shows the *cub*'s six alignment points:

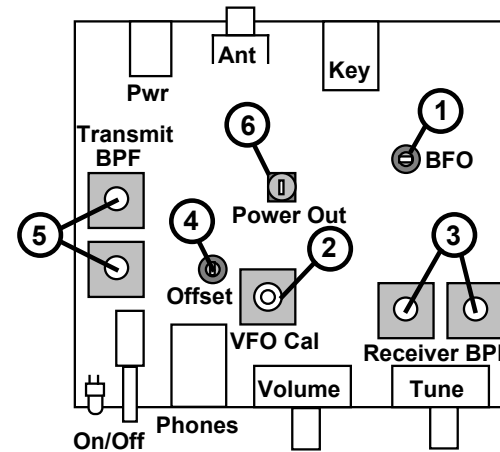

1. **BFO Frequency Adjust:** Trimcap C27 sets product detector operating frequency.
2. **VFO Calibrate:** Slug-tuned coil L3 sets the VFO tuning range.
3. **Receiver Bandpass Filter:** L1 and L2 peak the receiver's front-end for best weak-signal sensitivity.
4. **Transmit Offset:** Trimcap C40 sets CW-offset frequency for the desired pitch (most commercial transceivers provide a 600-Hz CW offset).
5. **Transmitter Bandpass:** L6 and L7 select the desired mixer product and peak the transmitter for maximum RF-output.
6. **Power Output:** Trimpot R19 (mixer drive) sets RF-level from zero to full output.

Alignment Procedures

Alignment begins with a ballpark adjustment of the BFO. If you're concerned about your ability to complete the alignment successfully, seek assistance from a more experienced ham or RF technician.

1. **Rough BFO Alignment (C27):** The BFO trimmer is adjusted so the product detector's operating frequency falls within the CW filter passband. Choose one of the following methods:
 - 1a. **Using a SW Receiver:** If you have a general coverage receiver with a digital readout, you may use it to "spot" the *cub*'s BFO operating frequency:

- ① Connect a pick-up lead to your receiver's antenna terminal and place it near the **cub**.
- ② Set SW receiver in CW mode and tune to the frequency indicated on the chart below.

MFJ-9380	MFJ-9340	MFJ-9330	MFJ-9320	MFJ-9317	MFJ-9315
9.996 MHz	11.996 MHz	5.996 MHz	9.996 MHz	9.996 MHz	11.996 MHz

- ③ Turn on the **cub** and adjust C27 for zerobeat.

1b. Using Broadband Noise: Alternatively, you may tune C27 to the CW filter passband frequency by ear. Use a short "noise pickup antenna" if additional background noise is needed to make the adjustment:

- ① Turn *Power* on and adjust for full volume, listening with phones or a speaker.
- ② Touch a test lead to R9 located just behind L1. This serves as a "noise antenna".

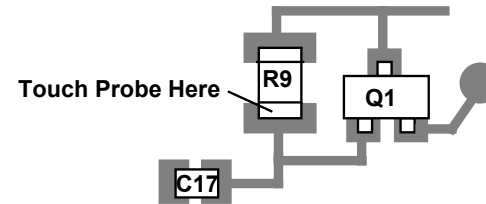

- ③ Using a non-conductive or insulated alignment tool, turn C27 through its range.

As you rotate C27, the timbre of the background noise should change audibly--making a swooshing sound. For stronger background noise, try placing the test lead near an operating computer or power cord.

- ④ Adjust C27 so background noise is at its lowest pitch.

You will re-set C27 for the correct sideband later on. The only objective for now is to make sure the product detector can "hear" signals passing through the CW filter.

2. VFO Alignment (L3): Locate the VFO operating range for your radio from the chart below:

VFO Operating Range	
MFJ-9380:	6.440 - 6.500 MHz (60 kHz range)

MFJ-9340:	4.940 - 5.000 MHz (60 kHz range)
MFJ-9330:	4.100 - 4.120 MHz (20 kHz range)
MFJ-9320:	4.000 - 4.060 MHz (60 kHz range)
MFJ-9317:	8.068 - 8.118 MHz (50 kHz range)
MFJ-9315:	9.000 - 9.050 MHz (50 kHz range)

These VFO frequencies cover the low-end of each band. Note that L3 may be re-tuned to cover a different CW segment if desired (for example, novice-band coverage on 80, 40, and 15 meters). Also, VFO tuning range may be altered by changing the value of C9.

2a. Using a Receiver: Adjust L3 by listening for the *cub*'s VFO signal.

- ① Connect a short pick-up lead to the SW receiver's antenna terminal.
- ② Set the *cub*'s *Tune* control (R4) fully counter-clockwise (CCW).
- ③ Tune the general-coverage receiver to the desired *low-end* VFO frequency (see chart).
- ④ Using an insulated tuning tool, carefully adjust L3 until the VFO signal is heard.
- ⑤ Rotate *Tune* control (R4) fully clockwise (CW).
- ⑥ Tune the general coverage receiver up in frequency to locate the VFO signal.

The VFO's high-end frequency should coincide roughly (within a few kHz) with the number provided on the chart.

2b. Using a Frequency Counter: This yields a direct readout of the VFO frequency.

- ① Set the counter for high-Z input, or couple the probe through a 33-pF cap.
- ② Turn on the *cub* and rotate the *Tune* control fully counter-clockwise (CCW).
- ③ Touch the test probe to the right terminal of trimpot R19, as shown:

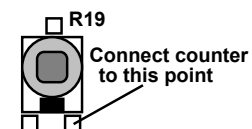

- ④ Adjust L3 for the *lower* VFO frequency listed on the chart.
- ⑤ Turn the **cub** 's *Tune* control fully clockwise (CW) and check the high-end reading.

VFO calibration should be touched up later using a known signal source before attempting to operate on the air.

Please note that *all cub* VFOs increase in frequency as you rotate R4 clockwise. However, the 80 and 40 meter radios use subtractive mixing--so *operating frequency decreases as the VFO frequency increases* (see below). For all other models, the operating frequency increases with VFO frequency.

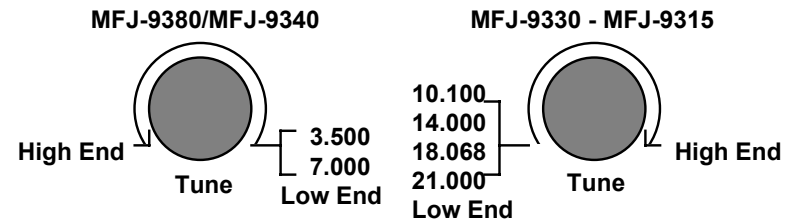

3. Receiver Bandpass Filter (L1, L2): These coils are peaked for best receiver sensitivity.

3a. Adjusting L1/L2 with a RF-Signal Generator:

- ① Connect the **cub** to a 50 ohm terminated signal generator.
- ② Set generator's frequency to the middle of the transceiver's tuning range.
- ③ Set signal level at 1-3 uV (below the receiver AGC threshold) with no modulation.
- ④ Tune in the generator's signal with the **cub** 's *Tune* knob (R14).
- ⑤ Monitor audio signal levels using a speaker, sensitive AC voltmeter, or oscilloscope.
- ⑥ Alternately tune L1 and L2 for maximum signal (repeat to tune out any interaction).

3b. Adjusting L1/L2 using Noise: If you don't have access to a signal generator, try the "noise" technique:

- ① Terminate the antenna jack with a 50 ohm load or 47 ohm resistor.
- ② Turn on the **cub** and adjust for full volume.
- ③ Touch a metal probe to the center pin of the antenna jack. Noise should increase.

- ④ Using a non-conductive tuning wand, adjust L1 and L2 for maximum noise.

3c. Adjusting L1/L2 with a Strong Signal Source: This is done while monitoring the radio's AGC voltage. To read AGC voltage, find the testpoint shown below:

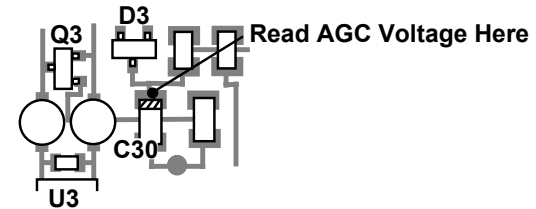

- ① Set the signal source for a frequency in the middle of the receiver's tuning range .
- ② Set a DVM or high-impedance voltmeter to the 3V (or 10V) scale.
- ③ Sample AGC voltage on the (+) end of C30 (end with white band).
- ④ Adjust L1, L2 for highest AGC reading (repeat to tune out any interaction).

Your receiver should now be *roughly* aligned and able to copy off-air CW signals with an antenna connected. If it is not correctly, re-inspect for construction errors.

Final Receiver Alignment

BFO Touch-up (C27): This adjustment tunes the BFO to the correct sideband (LSB).

- ① Apply a signal source (weak signal preferred).
- ② Monitor *cub* 's audio level (or AGC level) using a speaker, AC voltmeter, or scope.
- ③ Slowly rotate the *Tune* dial (R4) from a lower to a higher *operating frequency*, tuning across the signal. *This tuning direction will be counter-clockwise (CCW) for the MFJ-9380 and MFJ-9340, and clockwise (CW) for the MFJ-9330 - MFJ-9315.*

When C27 is correctly adjusted for CW-LSB (lower sideband), the test signal will be weak or inaudible on the low-frequency side of zero beat, and strong on the high side. Also, the CW tone will go *up in pitch* on the strong side as operating frequency is increased.

- ④ Adjust C27 so the signal is strong on the higher-frequency side of zero beat.

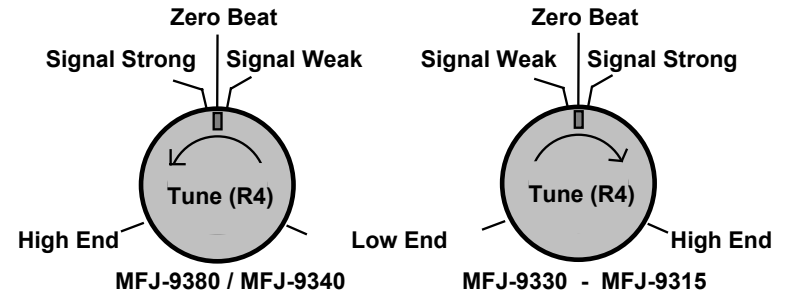

When C27 is set for optimum CW reception, the test signal should peak at around 600 Hz. If you have no other means of obtaining a 600 Hz reference tone, the C-note located one octave above middle-C on a piano is 512 Hz--and D is very close to 600 Hz. Make minor adjustments to C27 until you get the desired detector response.

- ⑤ Fine-tune C27 so peak response occurs at 600 Hz.

If you prefer a lower CW pitch--it's okay to reset C27 slightly to accommodate this preference. However, don't go too far...as the response peak is moved lower, opposite sideband rejection decreases.

VFO Touch-up (L3): MFJ recommends setting the transceiver's low-end operating frequency 3-5 kHz *above* the bottom edge of the band to prevent inadvertent out-of-band operation (3.505 MHz, 7.005 MHz, 10.105 MHz, 14.005 MHz, 18.073 MHz, or 21.005 MHz). You may do this now using an accurate signal source, or do it after the transmitter is tuned up by using a frequency counter or accurate receiver to monitor the *cub*'s signal.

Important Note: Radio Amateurs are solely responsible for determining the frequency of their transmissions and for staying within the licensed bands or sub-bands allocated to them by the FCC. MFJ cannot be held responsible for transceiver misalignment that results in out-of-band operation in violation of FCC rules.

This concludes receiver alignment. For transmitter alignment, connect a 50-ohm dummy load to the *Antenna* jack through a sensitive thru-line type RF power meter (2, 5, or 10-watt range). If a power meter isn't available, connect the 50-ohm load directly to the radio's *Antenna* jack and install a standard 5-mm

LED across the antenna terminals (either polarity okay). The LED will serve as a makeshift power indicator. Set the transceiver's *Power Output* trimpot (R19) at 12:00--or half scale.

4. Carrier Offset Adjustment (C40): This control establishes the pitch relationship between transmitted and received signals. The "industry-standard" CW offset is 600 Hz. The *cub* has no RIT control, so it's important to adjust C40 for offset somewhere *near* the 600-Hz standard (some operators prefer a slightly lower tone). If the offset is adjusted too low, signals replying to your calls may appear too high or low in pitch for comfortable copy. To set offset:

- ① Connect a key or keyer to the *Key* jack (J2).
- ② Set *Volume* about 1/2 open. Press the key.
- ③ Using an insulated tuning blade, adjust C40 for a 600-Hz tone.

Note that C40 usually has enough tuning range to move the sidetone signal through zero beat and into the upper sideband. However, the sidetone will be much louder on the LSB side--and this is the side you want.

5. Transmitter Bandpass Filter Tune-Up (L6, L7): L6 and L7 are adjusted for maximum RF power output. This may be measured on a QRP-type wattmeter--or by the relative brilliance of a LED. During initial tuning, the sidetone may become louder as you approach resonance. This is normal.

- ① Depress the key and observe power output indication (if any).
- ② Alternately adjust L6 and L7 for maximum output (repeat to tune out interaction).

Once the coils are roughly tuned, reduce transmitter output power below maximum using trimpot (R19)--and repeat the peaking procedure. This should yield a sharper peak.

6. Power Output Adjust (R19): Trimpot R19 adjusts transmitter RF output from zero to full power, permitting QRP operation. When setting for maximum RF output, increase R19 *only to the point where output begins to level off*. Turning R19 past this point overdrives the transmit mixer (U5), resulting in unwanted mixer spurs and "garbage" to the signal!

- ① Turn *Output* trimpot R19 fully counter-clockwise (down).
- ② Key transmitter and observe power meter (or LED).
- ③ Advance R19 until output no longer rises sharply.
- ④ Reduce R19 until output just begins to drop. *Stop at this point.*

Important Note: When setting R19 for maximum output, adjust only to the point where output begins to level off. Higher settings will overdrive the mixer and add unwanted spurs to your transmitted signal!

When constructed and tuned correctly, your *cub* should deliver approximately 1.5 to 2 watts RF output into a 50 ohm load (less on 15 meters, slightly more on 80 and 40 meters). This completes alignment of your radio. If it is working properly, proceed to final assembly.

FINAL ASSEMBLY

Prior to final assembly, remove any hardware on R4 and R14 (if applicable). Locate the bottom half of the case. Find two (2) 4-40 threaded pc mounting spacers, and the two (2) 4-40 mounting screws.

- Loosely mount the two (2) pc board spacers in holes provided at the rear of the case. Install each 4-40 screw to the top of the spacer only--the end of the screw should not protrude.
- Angle the pc board so controls, power switch, and LED pass through mounting holes at the front panel (see following illustration).
- Drop the rear of the board onto the spacers. If necessary, spring the rear panel slightly to allow the antenna jack (J3) to clear.

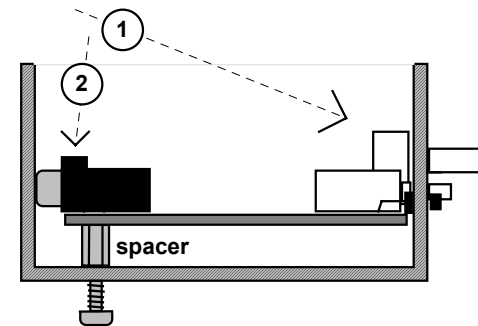

- Finish installing the two 4-40 screws and tighten each spacer in position.
- Find and install a 4-40 nut on each pc-board stud, securing the board to its spacers.
- Install a flat washer and nut on each potentiometer (R14 and R4). Tighten in place.
- Install the red power switch push-button (SW1).

- Find four (4) adhesive-backed rubber feet and install one at each corner of the case.
- Find the identification label for your model radio (page 43). Cut this out and apply it to the back panel using tape or glue-stick adhesive.

MFJ-93xxK OPTION

MFJ has made it possible for you to add a BNC connector to the *cub*. The hole in the chassis above the RCA jack is made available for a BNC connector. If you elect to add a BNC connector it can be installed now. Use an insulated wire to connect the BNC to the center pin of J3. This can be by done melting the solder and inserting the wire into the same hole as the center pin of the RCA jack (J3).

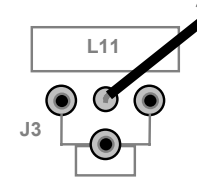

Find the cabinet lid and two (2) self-tapping screws. Note the hole punched in the top--orient so this hole is closer to the right side.

- Install the lid and secure it in place with the remaining screws.

The access hole is positioned directly above *Power Level* control R19, allowing you to adjust the *cub*'s power output level without removing the case.

OPERATING INSTRUCTIONS

An operation manual has also been provided with the kit. Please read it thoroughly before attempting to use your *cub* on the air.

IN CASE OF DIFFICULTY

If you encounter difficulty in the tune-up sequence, go back and double-check your work. While your radio *may* contain a defective SMD component, the pc board was inspected prior to shipping--and errors are relatively rare in automated assembly. Here are some tips for locating specific difficulties:

CR1 won't light: Check reverse-polarity fuse, CR1 reversed, wrong plug size at J1.

BFO won't tune: Y4 defective, L4 defective or incorrect value.

VFO won't calibrate: L3 defective or incorrect value, C6, C7 wrong values. Check polarity of D2, make sure R4 and R14 aren't reversed.

L1, L2 won't tune: L1 or L2 incorrect value, C11-C15 values incorrect. Diode switches D4-D7 defective, Q2 defective.

Transmit Offset (C40) won't tune: Y5 defective, L5 open or wrong value.

L6, L7 won't tune, low output: L6, L7 wrong values or defective, C44-C48 incorrect, U5 or Q5 defective, R19 turned down.

No RF output, low output: Trimpot R19 set low, Q6/Q7 defective, L8/L9 incorrectly values, L10/L11 incorrectly wound, C53, C55-C57 incorrect values.

Won't enter transmit: Q8/Q9 defective.

Poor receiver sensitivity: Q1, Q2, Q3, Q9 defective, Y1-Y3 defective.

Low or poor audio output: Check speaker/phones connection, value of R14, output loading (should be between 8 and 40 ohms).

Voltage Chart: If the above suggestions fail to identify the difficulty, voltage analysis of the transistors and ICs may isolate the problem. Any variation of 10% or more *may* indicate a problem. Exercise caution when testing SMD circuitry using conventional bench probes. If you lack tools and training to work on SMD circuitry, seek assistance.

IC Voltages

Pin	U1	U2	U3	U4	U5*
1	7.9	1.4	1.4	1.3	1.4
2	0	1.4	1.4	---	1.4
3	0	0	0	---	0
4	---	4.2	4.3	0	4.7
5	---	4.2	4.3	7.2	4.7
6	0	5.4	5.5	13.8	5.8
7	0	4.9	5.1	7.0	5.5
8	13.8	5.5	5.5	1.4	5.9

Transistor Voltages

	Q1	Q2	Q3	Q4	Q5*	Q6*	Q7	Q8	Q9
E/D	0	---	---	13.8	---	---	---	13.8	12.8
B/S	0.7	---	---	2.7	0.7	0.3	---	13.3	13.5
C/G	8.3	13.8	---	---	8.3	13.8	13.8	0.4	13.8

*Voltage values obtained with radio in transmit mode. Do not place test probe on Q7 during transmit--RF may damage meter.

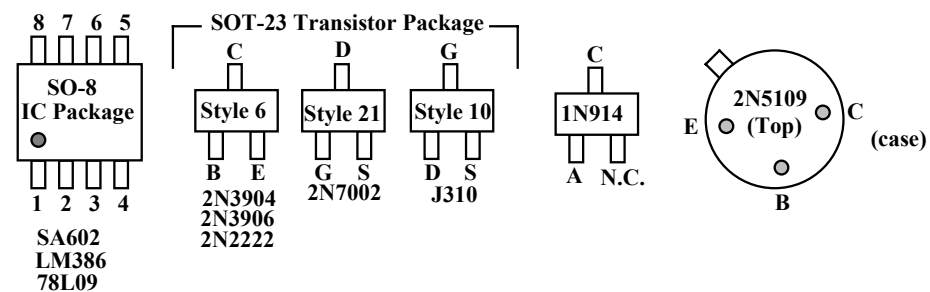

SCHEMATIC

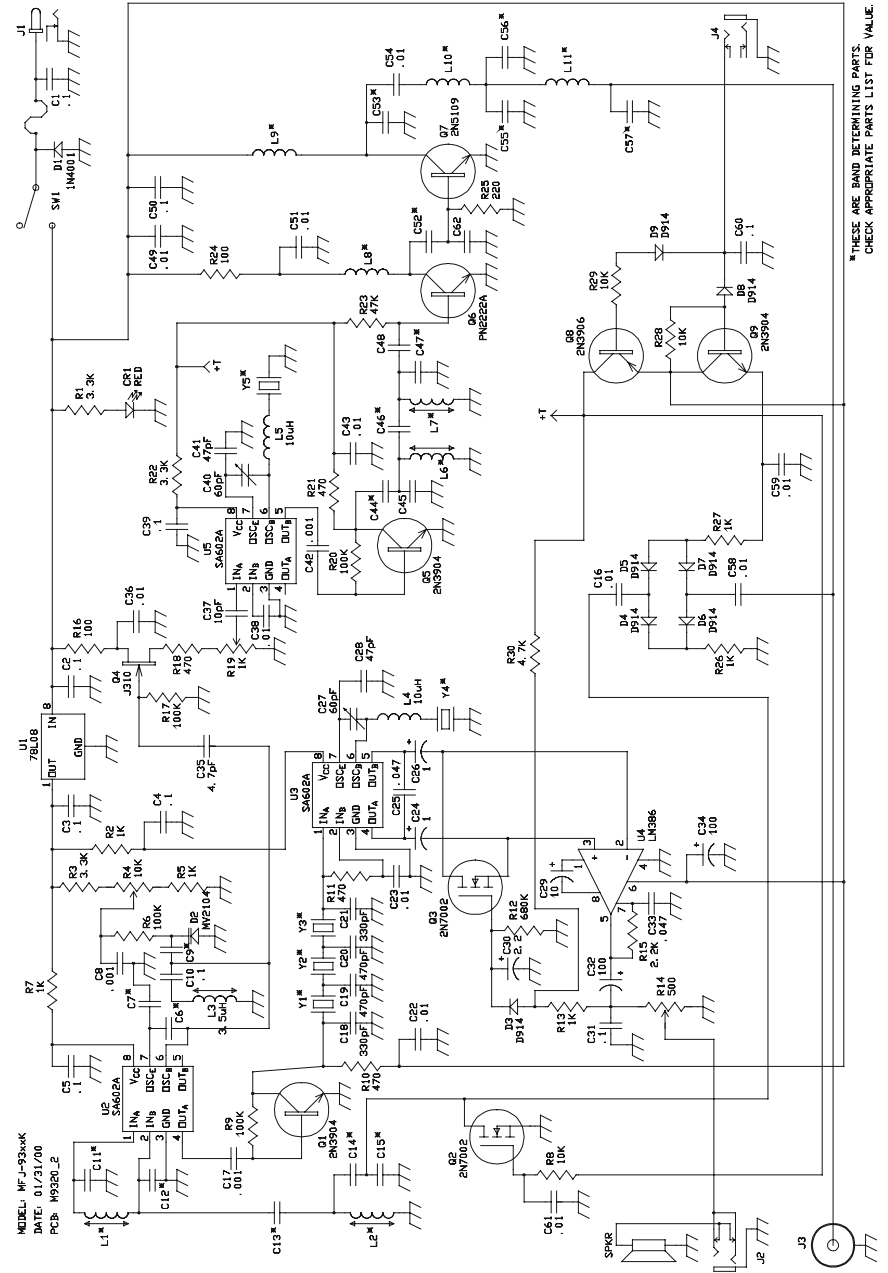

* THESE ARE BAND DETERMINING PARTS. CHECK APPROPRIATE PARTS LIST FOR VALUE.

Cut along this line

Model MF-J-9340
40 Meter
QRP CW Transceiver

Model MF-J-9320
20 Meter
QRP CW Transceiver

Model MF-J-9315
15 Meter
QRP CW Transceiver

Model MF-J-9380
80 Meter
QRP CW Transceiver

Model MF-J-9330
30 Meter
QRP CW Transceiver

Model MF-J-9317
17 Meter
QRP CW Transceiver

This page intentionally left blank.

NOTES

INTRODUCTION

Congratulations on purchasing the MFJ *cub* Transceiver. The *cub* takes advantage of SMD technology to achieve big-radio performance in a pocket-sized package. Whether you're taking a 10-minute DX break from the computer, or backpacking in the mountains, the *cub* is a great way to put the magic back into ham radio. Here are a few of the features we think you'll appreciate:

Hot Receiver: Pulls in *weak* QRP signals.

Low Noise: Virtually no noise contribution from receiver electronics.

Sharp Passband: Ladder filter and shaped audio reject unwanted QRM and QRN.

Differential-Mode AGC: Audio output holds steady over 80-dB signal range.

Robust AF Output: 100 mW AF amp drives headphones and speakers with ease.

Adjustable Transmitter: Power output continuously variable for QRP.

Full QSK: Seamless electronic switching for smooth break-in.

Natural Sidetone: Receiver monitors actual on-air signal.

Shaped Keying: Controlled envelope for click-free keying.

Custom Set-up: Transmit offset and receiver passband both user adjustable.

Low Power Drain: Runs from any lightweight regulated power source.

Truly Portable: Set up anywhere and tuck out of the way when not in use.

Simple to Use: Off/on switch, volume control, and tuning knob--that's it!

Attractive: Rugged aluminum case looks good, and it's built to last.

Ergonomic Layout: Controls conveniently positioned.

TYPICAL SPECIFICATIONS

Cub models are available for six popular QRP bands. Typical performance for each is shown in the following table:

Model	VFO MHz	Tuning kHz	IF Freq MHz	-6dB Selectivity	MDS Selectivity	USB dB	Power W*	Spurs dBc
9315	9	50	12	750	<.3uV	-38	1.0	-40
9317	8.06	50	10	600	<.3uV	-45	1.5	-40
9320	4	60	10	600	<.3uV	-45	2.0	-40
9330	4.1	20	6	350	<.3uV	-56	2.0	-40
9340	5	60	12	750	<.3uV	-38	2.2	-40
9380	6	60	10	600				

*RF power output at 13.8 Vdc supply voltage.

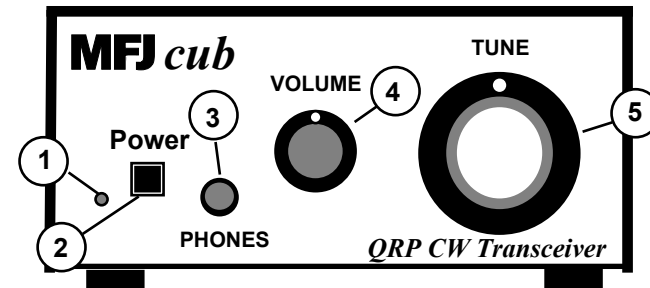
CONTROL LOCATIONS AND FUNCTIONS

1. **Power LED:** Indicates when transceiver is turned on.
2. **Power Switch:** Applies power to transceiver.
3. **Phone Jack:** Accepts 3.5 mm stereo headphone jack (stereo wiring).
4. **Volume Control:** Adjusts volume to comfortable level.
5. **VFO Tuning:** Selects transceiver's operating frequency.

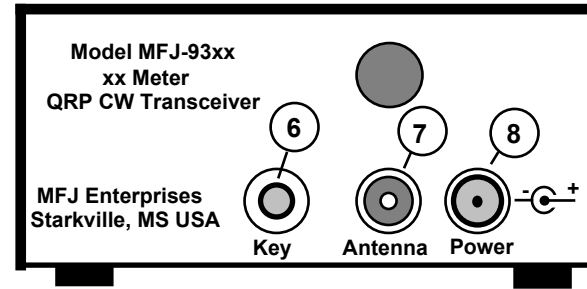

- 6. **Key Jack:** Accepts 3.5 mm plug from key or keyer, mono wiring.
- 7. **Antenna Jack:** Accepts RCA plug from 50 ohm antenna.
- 8. **Power Jack:** Accepts 5.5 mm OD, 2.1 mm ID coaxial plug, (+) to center.

QUICK-START OPERATING INSTRUCTIONS

Power Sources: The *cub* requires a regulated 12-14 VDC source capable of delivering 400 mA. Power connection requires a 5.5 mm x 2.1 mm coaxial plug (use Radio Shack 274-1567). Wire (+) voltage to center terminal, and (-) to common.

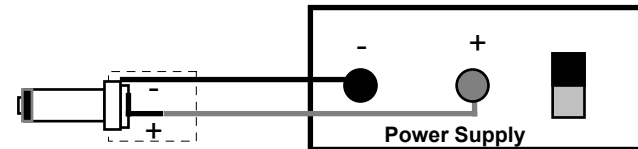

Important Note: Unregulated DC sources--wall cubes, solar panels, etc.--may damage your radio. A simple regulator circuit, like the one shown below, will provide protection. Note that U1's heat sink is 1.8 V above ground and must be isolated.

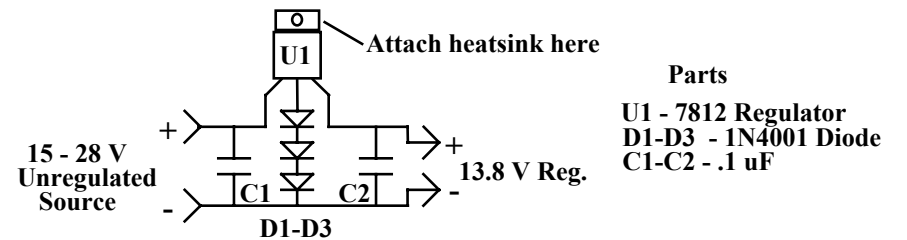

Headphones: Use standard walkman-type stereo headphones exhibiting 8-40 ohms impedance (higher-quality headsets often yield better performance). Alternatively, plug in any extension speaker with a similar load impedance. *Be sure to use only stereo type plugs--a mono plug will short the radio's audio output to ground!*

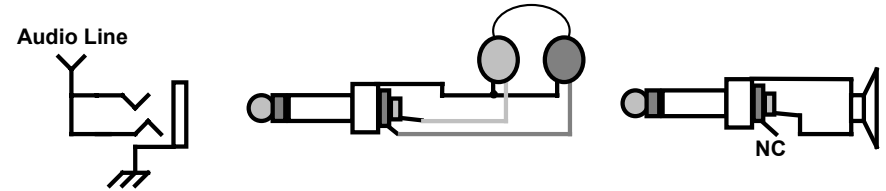

Keys and Keyers: Use any hand key or electronic keyer with a 3.5 mm plug (mono or stereo plug okay). Connect the key line to the jack's tip and the common line to the sleeve.

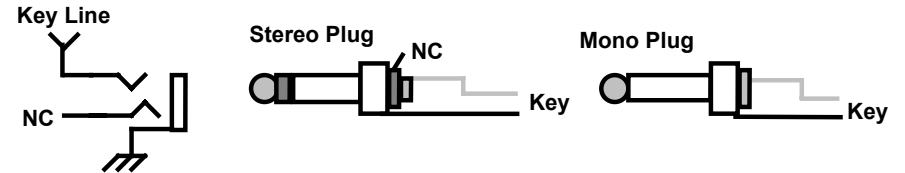

Antennas: The *cub* is designed to work with any efficient 50 ohm antenna exhibiting a VSWR of 2:1 or less. Suggested dipole lengths are shown in the following diagram, along with data for adding a simple coaxial choke-type balun:

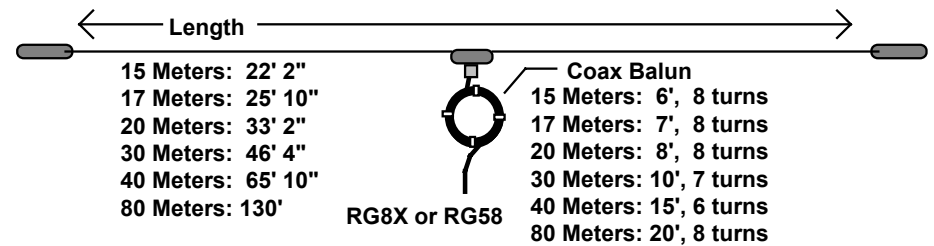

For best performance with any antenna, install as high and in the clear as possible. *The ARRL Antenna Handbook, The ARRL Antenna Compendium,* and many other amateur publications--including several from MFJ--offer additional antenna tips and suggestions.

Antenna Connection: The *cub* uses either a RCA antenna jack or the optional chassis-mounted BNC connector (mounting hole provided). For a direct transition from RCA to standard UHF (PL-238) connectors, use a Radio Shack scanner-adaptor plug RS278-208. Shorten the center pin--as shown--for easier insertion and removal.

**RS 278-208
UHF to
Motorola
Adapter**

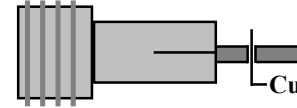

Cut here and smooth off tip with a file.

BNC-to-UHF transitions are also readily available if the optional BNC jack is installed.

Adjusting Power Output: The small hole in the center of the *cub's* cover provides access to a power-level trimpot (R19). For low power (QRP), adjust this trimpot counter-clockwise (CCW) with a small screwdriver while observing output on a QRP-type power meter. To increase power, turn the trimpot clockwise (CW). When resetting the *cub* for full power, note that output will increase rapidly then reach a plateau where it levels off. *Adjust R19 only to the point where the power increase begins to level off.* Attempting to wring the last few milliwatts from your radio by turning the trimpot fully clockwise will only overdrive the transmitter mixer stage and add unwanted spurious products to your signal.

GETTING INVOLVED WITH QRP

Technically speaking, operating QRP means limiting your transmitter power to below 5 watts on CW or below 10 watts PEP on sideband. However, for a growing number of licensed amateurs, the "QRP" moniker symbolizes a return to the basics of radio--with a strong emphasis on operating skills, experimentation, home construction, and fraternity. Spanning a continent or hopping oceans with less energy than it takes to illuminate a night light is not only exciting, it borders on the miraculous. Yet, QRP enthusiasts do it every day--often using simple home-built equipment running only microwatts of power. Even staunch QRO contesters have succumbed to the lure and challenge of QRP, revisiting DXCC while running 5 Watts or less. For many, operating "QRP" restores that special sense of personal achievement that's too easily lost when high-tech appliances invade the ham shack. Regardless of motivation, this particular segment of the ham radio community is growing steadily and continues to thrive as other techno-fads come and go.

QRP Calling Frequency: To meet up with other low-power enthusiasts, try operating on the QRP International Calling Frequencies. These are popular gathering places for people who share your interest in QRP activities:

80 Meters:	3.560 MHz	(3710 Novice)
40 Meters:	7.040 MHz	(7.110 Novice)
30 Meters:	10.106 MHz	
20 Meters:	14.060 MHz	
15 Meters:	21.060 MHz	

QRP-A.C.R.I.: To learn more about QRP activities, your best resource is *QRP Amateur Radio Club International* (or QRP-A.R.C.I.), a worldwide organization supporting low-power operation and home construction. This popular group sponsors several contests a year, publishes *QRP Quarterly Magazine*, and coordinates an annual QRP conference in tandem with Dayton Hamvention. You can find QRP-A.R.C.I. on the World Wide Web at www.qrparci.org. They also provide links to local and regional QRP clubs around the world, plus links leading to a wealth of operating and technical information.

QRP DX Operating Tips: Competing with more powerful stations to capture QSLs from rare DX prefixes requires patience and good operating skills. Here are 10 tricks-of-the-QRP-trade you can use with your *cub* to land the tough ones!

1. Hunt and pounce! There's never a pileup if you're the first one there.
2. Seek out and answer CQs (as opposed to repeatedly calling CQ).
3. Add */QRP* to the end of your call. Let others know you're running low power.
4. Answer CQs from weak stations as well as strong--they may be QRP too.
5. Be patient in pileups. You'll get the same QSL whether you're first or last in line!
6. Use QSB and band swings to advantage. When they get stronger, you might too!
7. Look before you leap. Wait for a lull to sneak in your call.
8. Move up or down from the pileup. Being on the edge helps your signal stand out.
9. Call DX stations as they wrap up QSOs (but not over the other station's final).

10. Pay attention to DX forecasts. When the band is hot, power differences matter less.

CIRCUIT DESCRIPTION

In receive, Chebechev filter L1-L2 preselects incoming signals. U2 converts signals to the IF using its internal LO as a varactor-tuned VFO. IF amp Q1 drives ladder filter Y1-Y3. Product detector U3 recovers the AF product, using its internal LO as a crystal-controlled BFO. Audio is then routed to AF amplifier U4 through differential attenuator Q3. U4, which is EQ'd for CW, selectively amplifies signals to speaker-level. Level detector D3 samples U4 output and returns a AGC signal to attenuator Q3. Volume is controlled by a resistive attenuator downstream of the level detector. The receiver remains on in transmit mode to provide CW sidetone.

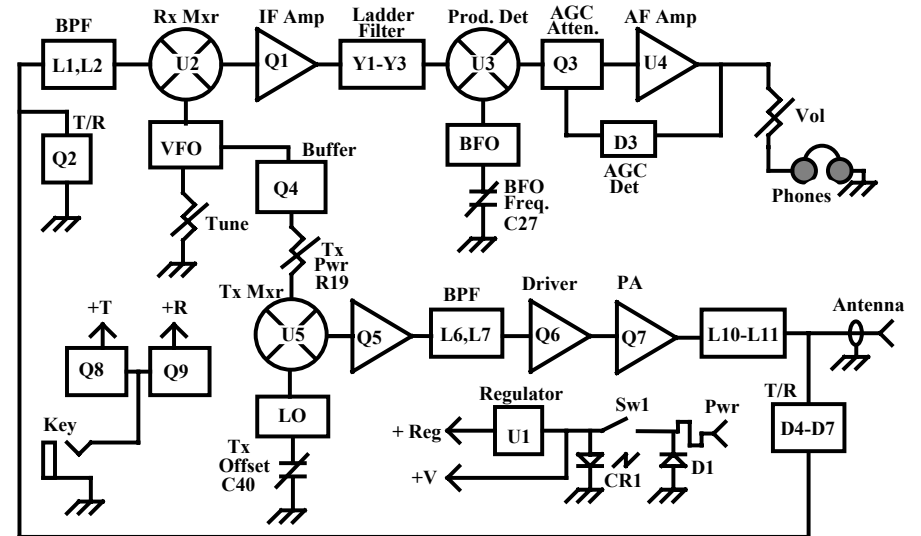

In transmit, buffer Q4 samples U2's VFO signal and feeds it through attenuator R19 to transmit mixer U5. Q5 boosts U5 output, and Chebechev filter L6-L7 selects the desired mixer product. Driver Q6 boost the filtered signal and feeds it through an L network to class-C PA amplifier Q7. +T switch Q8 is keyed to generate CW characters. This powers U5, Q5, and the bias line to Q6. Pi-filter L10-L11 reduces transmitter harmonic content.

On key-down, antenna switch D4-D7 is biased open by Q8. Also, Q2 is biased into conduction by Q9--pulling the receiver input to ground. These two gates

produce -75 dB port isolation, allowing the receiver to monitor the transmitted signal without overload. Crowbar diode D1 protects circuitry from reverse-polarity power connection, and LED CR1 indicates when the radio is on. Construction is hybrid, employing a mix of SMD and conventional "through-hole" components to reduce size and increase reliability.

IN CASE OF DIFFICULTY

If you experience a problem with your *cub*, look through the checklist below to determine if it's something simple you can fix yourself. If that fails to resolve the problem, you may contact *MFJ Technical Service* at **662-323-0549** or the *MFJ Factory* at **662-323-5869**. You will be best helped if you have your unit, manual and all information on your station handy so you can answer any questions the technicians may ask.

You can also send questions by mail to MFJ Enterprises, Inc., 300 Industrial Park Road, Starkville, MS 39759; by Facsimile to 662-323-6551; or by email to techinfo@mfjenterprises.com. Send a complete description of your problem, an explanation of exactly how you are using your unit, and a complete description of your station.

Won't Power Up: Check power source and associated cables/plugs. Check reverse-polarity fuse (pc trace behind power jack). If blown, replace with loop of #32 wire.

No Signals Heard: Check antenna and feedline for breaks and shorts. Is the band dead? Try a different antenna.

Unwanted Signals: Intermod from strong BCI may be overloading the frontend. If using a large multiband antenna, try a smaller monobander. Also, check station ground.

Intermittent Audio: Check headphones or extension speaker and cord/plug.

No Transmit: Check key or keyer and its cord/plug. Is the keyer battery okay?

Sidetone, But No RF Out: Is R19 turned down? Check patch cord to power meter.

MFJ CUB ALIGNMENT AND SERVICE NOTES

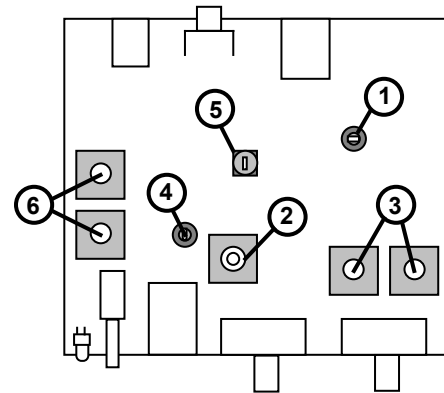

Alignment Control Function

- 1. BFO Trim (set for 600-Hz LSB passband center)
- 2. VFO Cal (set for desired CW band segment)
- 3. Rx BPF (tune for maximum sensitivity)
- 4. Tx Offset (set for 600-Hz sidetone pitch)
- 5. Power (set for onset of gain compression)
- 6. Tx BPF (tune for maximum power output)

Important Note: If you lack the necessary test equipment and skills to make these adjustments, seek assistance from a qualified technician. Misalignment will degrade transceiver performance and may also result in spurious out-of-band operation in violation of FCC rules. MFJ *cannot* be held responsible for transceiver misalignment in the field.

Voltage Chart: Voltage charts are useful for diagnosing circuit problems and isolating component failures. Any voltage variation of 10% or more *may* indicate a problem.

Important Note: Exercise caution when testing SMD circuitry with conventional bench probes. If the voltmeter probe shorts to adjacent pins during the measurement, component damage may result. If you lack the tools and training to troubleshoot SMD circuitry, seek assistance.

Transistor Voltages

	Q1	Q2	Q3	Q4	Q5*	Q6*	Q7	Q8	Q9
E/D	0	---	---	13.8	---	---	---	13.8	12.8
B/S	0.7	---	---	2.7	0.7	0.3	---	13.3	13.5
C/G	8.3	13.8	---	---	8.3	13.8	13.8	0.4	13.8

*Voltage values obtained with radio in transmit mode. Do not place test probe on Q7 during transmit--RF may damage meter.

IC Voltages

Pin	U1	U2	U3	U4	U5*
1	7.9	1.4	1.4	1.3	1.4
2	0	1.4	1.4	---	1.4
3	0	0	0	---	0
4	---	4.2	4.3	0	4.7
5	---	4.2	4.3	7.2	4.7
6	0	5.4	5.5	13.8	5.8
7	0	4.9	5.1	7.0	5.5
8	13.8	5.5	5.5	1.4	5.9

Component Pinout:

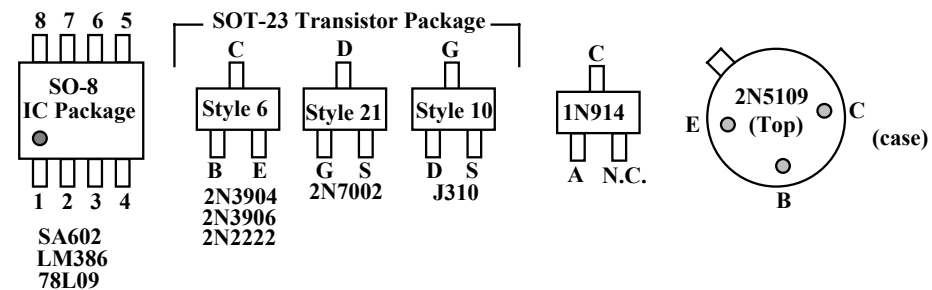

PARTS PLACEMENT

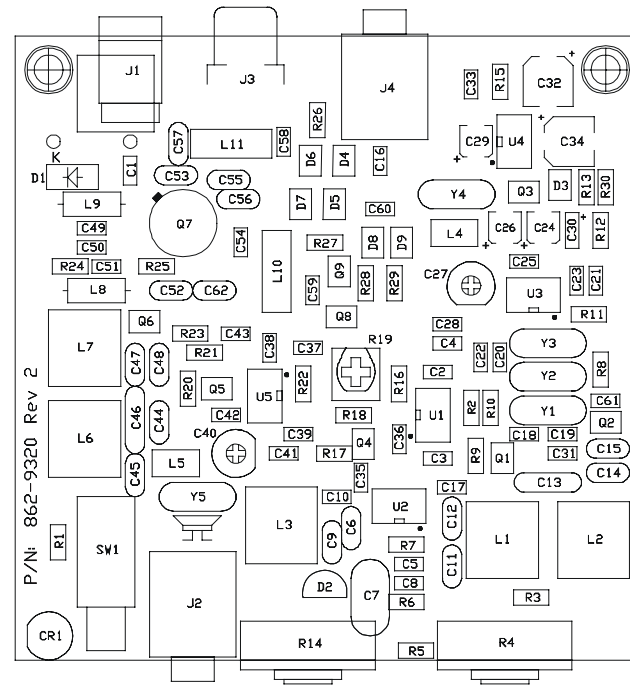

SCHEMATIC

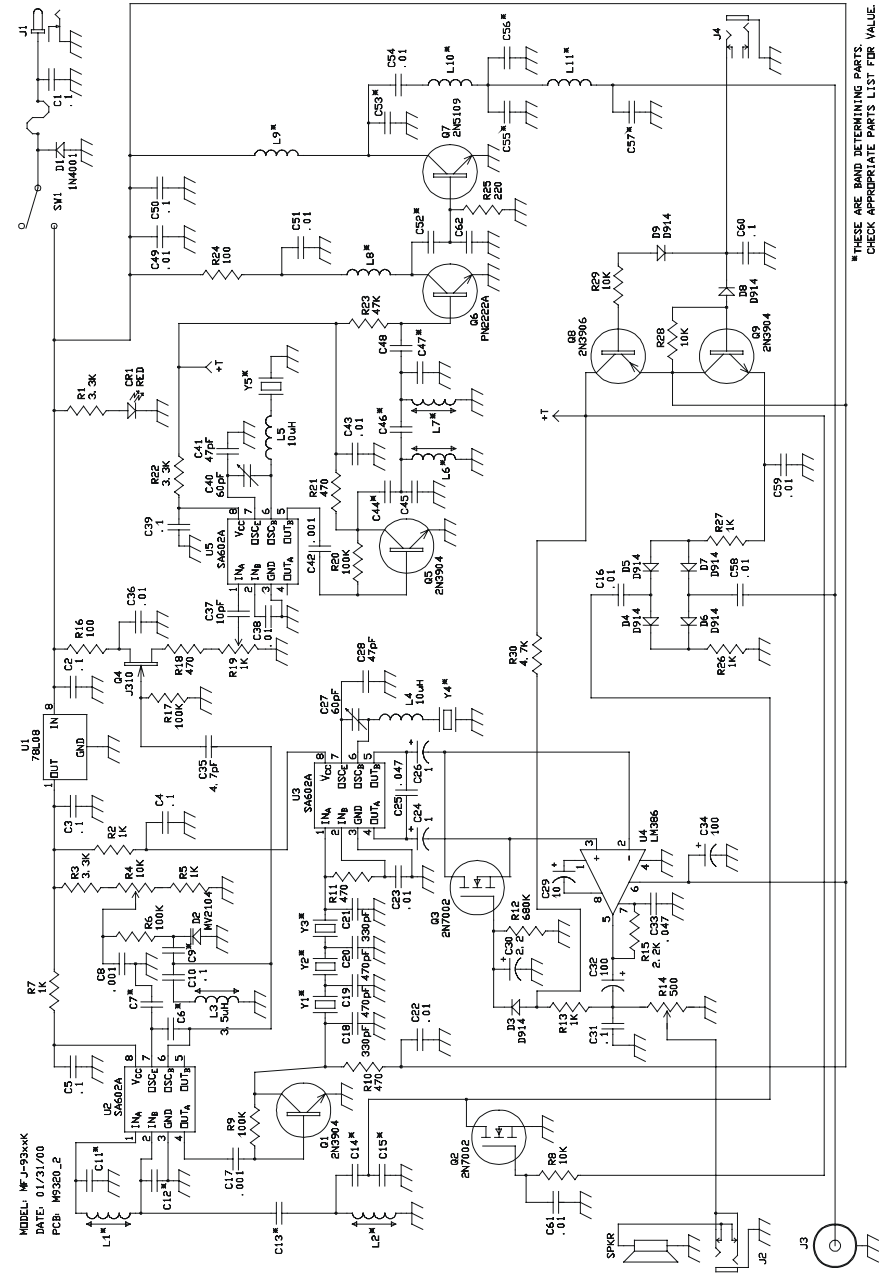

*THESE ARE BAND DETERMINING PARTS.
 CHECK APPROPRIATE PARTS LIST FOR VALUE.

NOTES