

# The MKARS 80 QRP 80M transceiver

## Construction and user manual

Author - Steve Drury G6ALU

### List of contents

Section	Page no.
1. Specifications	2
2. Introduction	2
3. Construction	3
4. General construction practice	3
5. Component placement	4
6. Initial testing	11
7. Alignment	12
8. PCB options	13
9. Boxing up	14
10. In use	15
11. Plug and socket fitting instructions	16
12. Component Identification	18
13. Fault finding	20
14. Block diagram and circuit description	22
15. Circuit diagram	24
16. PCB overlay	25
17. Change log	26

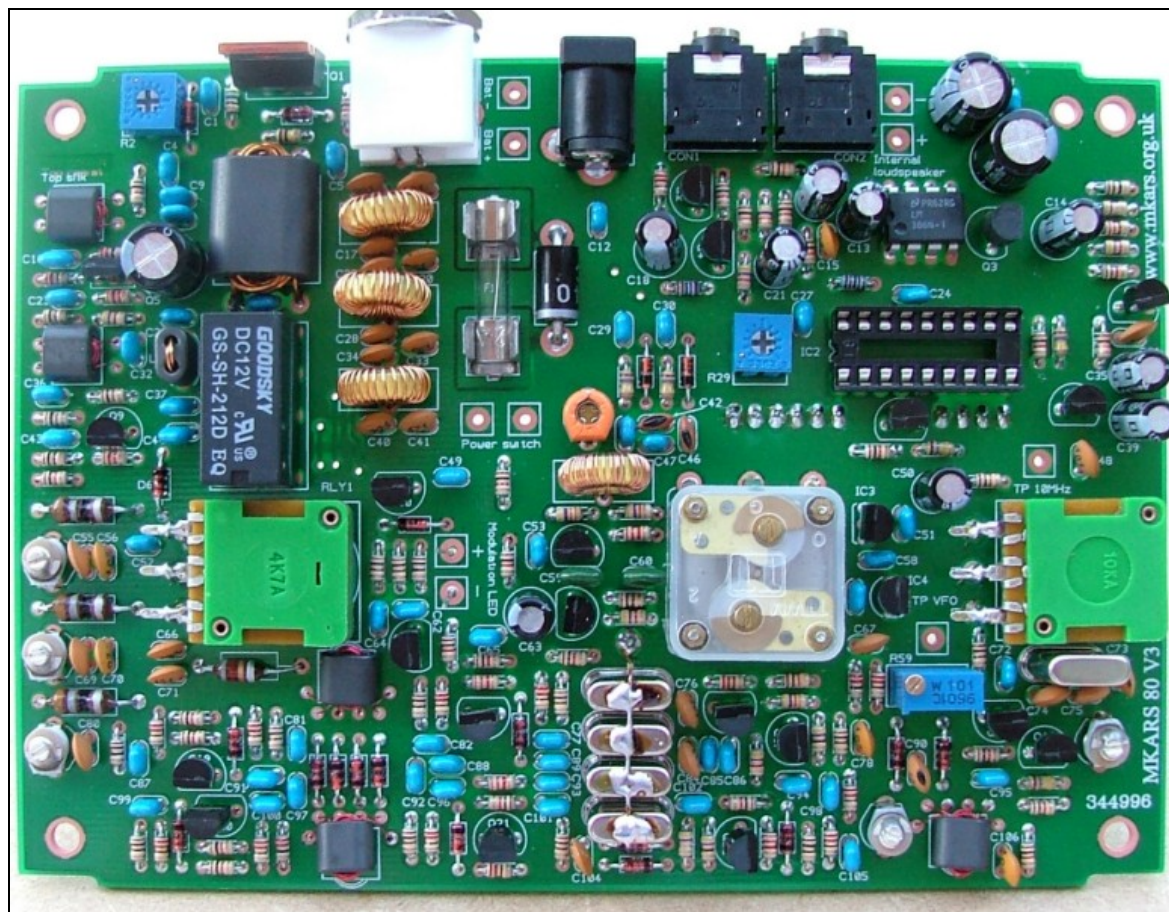

## Features

- Full 80M LSB coverage
- > 5 Watts output power
- Frequency display with “Huff and Puff” circuit
- Modulation monitor – helps stop over modulation
- Volt meter – useful for battery operation
- Reverse polarity protection (fuse protected)

## Typical Specifications (13.8V supply)

Operating Frequency	-	3.5 – 3.8 MHz
RF output	-	> 5 W
Sensitivity	-	MDS better than 1 uV
IF frequency	-	9.998 MHz
Audio output	-	Approximately 0.5W
Current consumption	-	Receive 120 mA (no signal), Transmit 1.2 amps
Supply voltage	-	10 – 16V
Microphone	-	Low cost electret type
Loudspeaker	-	8 Ohm (will work into 4 Ohm)

## Introduction

As significant interest had been shown by Milton Keynes Amateur Radio Society members for a transceiver construction project, I decided to produce a kit for the Epiphyte originally designed by the QRP club of British Columbia. Unfortunately this design used several obsolete components, whilst searching around I became aware of the BITX20 designed by Ashhar Farhan. The BITX20 is a low technology transceiver designed to use “simple” components and is easily adapted to other bands, I quickly manufactured a variant for 80M (version 1). The radio presented here is a development of that; now at version 3.

Many changes have been made through my experience with the first prototype, the original design philosophy was to keep the radio very simple and basic but I quickly appreciated the benefits of a frequency read-out and “Huff and Puff” VFO stabilisation. The original design didn’t have an RF gain control so would overload very easily with the large signals on 80M, the volume potentiometer was therefore moved to the front of the receiver becoming an RF gain control.

Another requirement was for all components to be mounted on to one PCB, keeping wiring to a minimum and PCB cost low. The prototype used Toko coils but many of these are now hard to obtain so either fixed inductors or inductors using readily available and low cost cores have been used throughout.

## Construction

These instructions have been targeted at those with some construction experience and who can identify the different components. Where out of the ordinary parts have been used a short description follows the component value.

All components except for the display, its socket and modulation LED are mounted on the component side of the board. The PCB silk-screen gives the component locations, in cases where this is difficult to read please refer to the printed overlay that is larger than actual size. Note that components are numbered from left to right then top to bottom of the board. If you have difficulty in locating a component position place a straight edge across the overlay and look along its length, in this way components will be easy to locate.

The PCB has been designed to accommodate the components supplied so if it doesn't easily fit ask yourself if it belongs there!

## General construction practice

Leaded or lead-free cored solder may be used, the solder must be designed for electronics – do not use plumbers solder or additional flux, as the flux is very corrosive. I use 22SWG (0.7mm) multi-core type solder that seems most suitable for this type of work. A double sided plated through hole (PTH) PCB has been used, this has the advantage of greater stability and makes dry

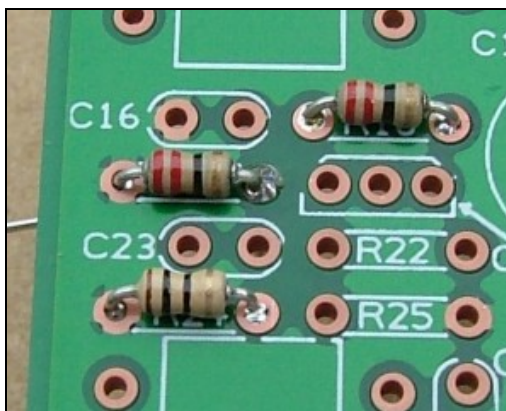

joints very unlikely; however incorrectly fitted components can be very difficult to remove so it's important to fit them in the right place first time! If a component is inadvertently fitted incorrectly it is easiest to cut off its leads, apply the soldering iron and pull them out from the topside. A small solder sucker or de-solder braid can be used to clear the holes out ready for a replacement component to be fitted. When soldering the component leads it will be noticed that the solder "wicks" up the hole through to the top surface, this is normal.

For a start place just a few components in place before soldering them, as experience grows you may find it more productive to fit a larger number at a time. As *each* component is fitted put a mark in the box provided, it's very easy to forget the last component fitted especially if you are distracted. If you make use of the component overlay you will find it helpful if components are highlighted as they are fitted.

Components are taken from one bag at a time keeping the others sealed, some component types are split between several bags so

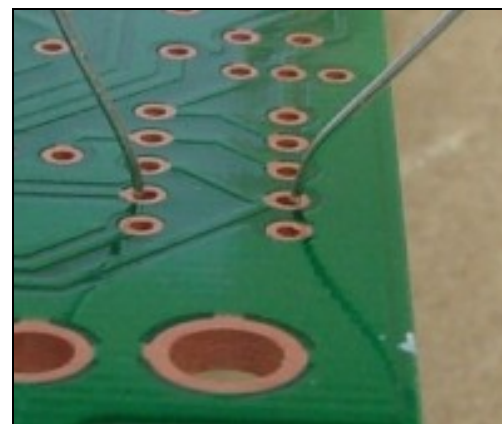

indistinguishable parts don't become confused (especially zener diodes and trimmer capacitors). Everyone has their preferred method of retaining components prior to soldering; I pull the leads through with long nose pliers and put a bend in the component lead to stop it falling out of the board. A good policy is not

to crop leads until they have been soldered, this should stop you from missing any soldered joints. As this is a PTH board leads can be cropped quite close to the PCB without damaging the soldered joint.

Note that the PCB shouldn't be cleaned with solvents as residue may enter the trimmer capacitors and any surface treatment designed to aid soldering will be removed.



Where possible fit the components so their values are easily readable. Some components MUST be fitted in the correct orientation as they are polarised; this will be indicated in the text. Save all the cropped leads, as some will be needed to fit the display later in construction and may also be used as test loops.

The components are packed in six bags, each bag contains a list of contents which will show any substitutions that have been made.

### Component placement

Resistors are quite small and are identified by four or five colour bands; if in doubt use a multi-meter to confirm their value.

From bag 1 fit the following components:

4R7 Resistor (Yellow, Violet, Gold, Gold)			
R10		R89	

10R Resistor (Brown, Black, Black, Gold)			
R8		R24	R36
R72		R46	R62

22R Resistor (Red, Red, Black, Gold)			
R16		R19	R57
			R87

56R Resistor (Green, Blue, Black, Gold)	
R1	

100R Resistor (Brown, Black, Brown, Gold)					
R32		R33		R44	R45
R52		R61		R69	R71
R83		R88		R92	
					R48
					R81

220R Resistor (Red, Red, Brown, Gold)					
R7		R14		R55	R58
R63		R66		R68	R77
R84		R86		R93	R96
					R60
					R82

470R Resistor (Yellow, Violet, Brown, Gold)			
R25		R70	R90

1k Resistor (Brown, Black, Red, Gold)					
R3		R6		R9	R13
R26		R34		R38	R39
R50		R51		R53	R65
R73		R78		R79	R80
R94		R95			R18
					R47
					R67
					R85

2k2 Resistor (Red, Red, Red, Gold)							
R22		R37		R43		R54	
R91							

Be careful not to mix the 4K7 and 47K resistors, these two values are often confused.

4k7 Resistor (Yellow, Violet, Red, Gold)							
R15		R20		R49		R74	

10k Resistor (Brown, Black, Orange, Gold)							
R5		R11		R17		R28	
R56							

47k Resistor (Yellow, Violet, Orange, Gold)							
R12		R41		R42		R64	

100k Resistor (Brown, Black, Yellow, Gold)							
R4							

180k Resistor (Brown, Grey, Yellow, Gold)							
R27		R30		R31		R35	
						R76	

The following resistors are metal film close tolerance types with the value marked as 5 coloured bands.

12k 1% Resistor (Brown, Red, Black, Red, Brown)							
R21							

33k 1% Resistor (Orange, Orange, Black, Red, Brown)							
R23							

100pF NP0 Ceramic (Marked 101)							
C45							

1nF NP0 Ceramic (Marked 102)							
C59		C60					

The orientation of trimmer capacitors is marked by the PCB legend, its best to fit as directed so that the adjustment screw is at ground potential.

5.5 - 30pF Open trimmer (Non-enclosed trimmer capacitor)							
C103							

Zener diodes are polarised – that is they can only be fitted one way round, there is a band on one end of the glass envelope which should match up with the band marked on the overlay.

2V7 400mW Zener diode							
D7							

All the following components are taken from bag 2.

10pF Ceramic (10)							
C42		C46		C90			

22pF Ceramic (22)							
C73							

68pF NPO Ceramic (68)							
C47							

100pF Ceramic (101)							
C31		C48		C55		C67	C76
C80		C104					

120pF Ceramic (121)							
C66		C69		C71			

220pF Ceramic (221)							
C74		C75		C84			

390pF Ceramic (391)							
C7		C40					

470pF Ceramic (471)							
C8		C41					

560pF Ceramic (561)							
C17		C20		C22		C28	C33
C34							

1nF Ceramic (102)							
C15		C56		C70		C78	C106

9-50pF NPO Enclosed trimmer (Orange plastic body)							
C38							

9-50pF Open trimmer (Non-enclosed trimmer capacitor)							
C54		C68		C79		C83	

5V6 400mW Zener diode (markings are indistinct)							
D1							

Axial inductors have a similar appearance to resistors but larger in size, if measured by a multi-meter they will read a very low resistance.

18uH Axial inductor (Brown, Grey, Black, Silver)							
L6		L7		L9			

Fit the following components from bag 3

33V 400mW Zener diode							
D4		D5					

100nF Ceramic (104)							
C1		C3		C4		C5	C9
C11		C12		C16		C23	C24
C25		C26		C27		C29	C30
C32		C36		C37		C43	C44
C49		C51		C52		C53	C58
C61		C62		C64		C65	C72
C77		C81		C82		C85	C86
C87		C88		C89		C91	C92
C93		C94		C95		C96	C97
C98		C99		C100		C101	C102
C105							

10uH Axial inductor (Brown, Black, Black, Silver)							
L8							

### Winding the inductors and transformers

This is probably the trickiest part of the build although with a little care is not too difficult. The thickest wire has the lowest SWG number; 38 SWG is the thinnest, 22 SWG the thickest. Fit all the toroid inductors vertically against the PCB, refer to the photo of finished radio.

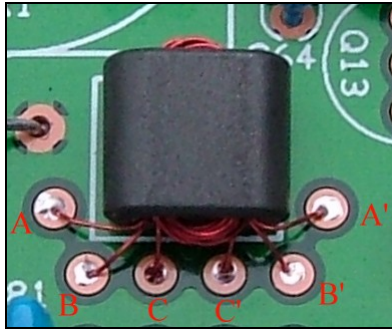

T4, T5 and T6 – These transformers are trifilar wound, that is 3 wires are wound through the ferrite core at the same time.

First cut three pieces of 38 SWG wire (the thinnest supplied) about 30cm long and at one end tightly twist all three together for about 12mm, snip the end off and solder together – this will make it easier to thread the wires through the ferrite core.

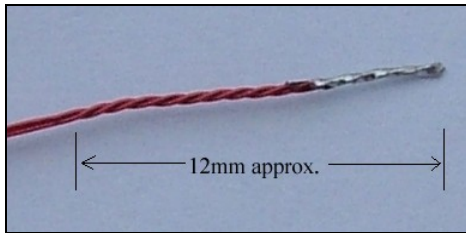

The remaining length may be lightly twisted to stop it getting tangled.

Thread the soldered end through one of the holes of a BN43 – 2402 core (the

smallest core, see photo) leaving about 10cm remaining then thread the wire back through the other hole – this is one complete turn. Loop the soldered end through a further 4 times to make a total of 5 turns. Trim the wires back to about 50mm in length, splay apart and tin the ends with solder.

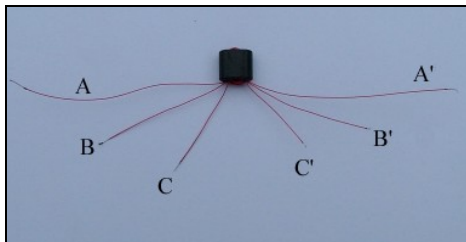

Now the ends of each of the three wires has to be identified. To do this use a multi-meter on the ohms or continuity range, when the first wire has been identified bend it backwards out of the way. Locate the

second wire, trim these two ends to about 30mm in length, and now confirm the last two ends belong to the third wire and crop to about

15mm in length. These wires are then passed through the PCB longest first and shortest last, anchor the transformer into the PCB by bending 4 wires over against the board. Trim the remaining 2 wires to just a few mm in length and solder in place; be careful to make sure that the enamel burns away and the wire tins properly. Once the first two wires have been soldered in place the other four may be cropped and soldered. After the radio has been completed (and tested) the transformers may be fixed into position with a little non-acidic silicon adhesive, note that bathroom sealer is not suitable as it exudes acetic acid whilst curing. The correct adhesive doesn't have any smell.

BN43-2402 5T Trifilar wound 38 SWG ECW					
T4		T5		T6	

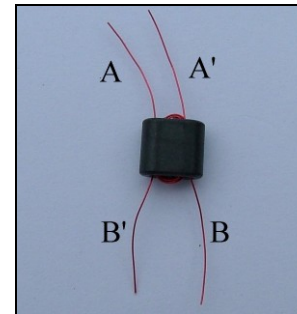

T1 and T3 – these have two windings, each with 5 turns of 38 SWG wire. First wind 5 turns through the core from one end of the transformer and crop the leads at 20 – 40mm in length then turn the transformer round and repeat with another 5 turns from the other end. It is easiest to tin these wires before fitting the transformer to the PCB.

BN43-2402 5T+5T 38 SWG ECW			
T1		T3	



T2 is wound using the same method as for T1 and T3 but the windings have three turns of 22 SWG wire on the larger BN43-0202 core.

BN43-0202 3T + 3T 22 SWG ECW	
T2	

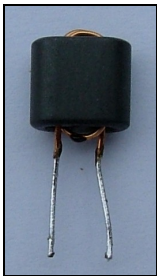

L3 – wind 2 turns of 27 SWG wire through the holes of a BN43-2402 core and tin the leads.

BN43-2402 2T 27 SWG ECW	
L3	



L1 and L4 – Cut off approximately 40cm of 27 SWG wire and pass half of it through the center of a T37-6 core, this counts as the first turn. Now wind a further 14 turns through the core using one end of the wire, turn the core over and wind the other end through the core 15 times making a total of 30 turns. Whilst winding pull the wire tight so the turns lay touching each other. Crop the wires to 10 – 20mm in length and tin the ends with solder.

L2 is wound in a similar way with the same 27 SWG wire but has a total of 32 turns. Keep the turns tight but it doesn't matter if several turns overlap.

L5 – use approximately 50cm of 33 SWG wire and wind using the same procedure as the other toroid cores with a total of 40 turns, space the wires evenly around the core.

T37-6 30T 27 SWG ECW			
L1		L4	

T37-6 32T 27 SWG ECW	
L2	

T37-6 40T (4.8uH) 33 SWG ECW	
L5	

Electrolytic capacitors are polarised so may only be fitted one way round. By convention the PCB is marked with a + symbol, the + lead of a capacitor is longest, the capacitor sleeve is also normally marked -. Fit the capacitors against the PCB with zero lead length but don't put excessive force on the leads as this can make the electrolyte leak out.

1uF 63V Electrolytic					
C10		C13		C21	

10uF 25V Electrolytic	
C50	

47uF 16V Electrolytic			
C14		C18	

220uF 25V Electrolytic	
------------------------	--



C2		C6		C19		
----	--	----	--	-----	--	--

Fit the following from bag 4.

IC3 and IC4 have 3 legs and look like small transistors.

78L05						
IC3						

78L08						
IC4						

LM386N-1						
IC1						

Diodes are polarised devices so can only be fitted one way round, match the band on one end of the encapsulation with the bar printed on the PCB.

1N4148 Diode									
D2		D6		D8		D9		D10	
D11		D12		D13		D14		D15	
D16		D17		D18		D19		D20	

1N5401 Diode						
D3						

Transistors should be fitted so their outline matches that printed on the PCB.

BC337 Transistor (Marked C337-40)						
Q3						

BC547 Transistor (Marked BC547)									
Q2		Q4		Q6		Q7		Q8	
Q10		Q11		Q12		Q13		Q14	
Q15		Q16		Q17		Q18		Q21	
Q22									

MPSH10 Transistor						
Q9		Q19		Q20		

Fit Q5 with approx 2mm spacing to the PCB.

ZTX651 Transistor						
Q5						

100R Multi-turn preset resistor						
R59						

10k Miniature preset resistor						
R2		R29				

Set R2 fully ANTI-CLOCKWISE and R29 fully CLOCKWISE.

Fit 18 pin socket to IC2 position with notch to match indication on PCB.

Break the 10 pin single in line header strip into two parts, one of 4 pins and the other 6 pins. Fit to UNDERSIDE of PCB, and solder connections on component side.

Fit 2 fuse clips noting they should be fitted the correct way round due to fuse locating “tang”.

Crystals XTAL 2 – 5 require their cans grounding, before fitting the crystals solder a short length (5 – 6cm) of tinned copper wire (or a tinned piece of 22 SWG ECW) to the pad provided adjacent to XTAL 2.

10MHz HC49U Crystal (Marked ACT W6)					
XTAL	XTAL	XTAL	XTAL	XTAL	
1	2	3	4	5	

Solder already fitted grounding wire to crystal cans and trim off excess – see photo of completed PCB.

Fit Q1 into the PCB as far as possible – note the orientation shown on the PCB overlay. Do not crop the leads right down to the PCB, leave about 5mm so the transistor position can be adjusted if required when fitting in to a case.

IRF510 FET	
Q1	

Fit the following parts from bag 5, ensure all the sockets are fitted flush to the PCB with no gaps underneath.

Stereo 3.5mm jack socket	
CON1	

Mono 3.5mm jack socket	
CON2	

PCB Mount BNC socket	
CON3	

2.1mm DC Socket	
CON4	

Relay, BT type	
RLY1	

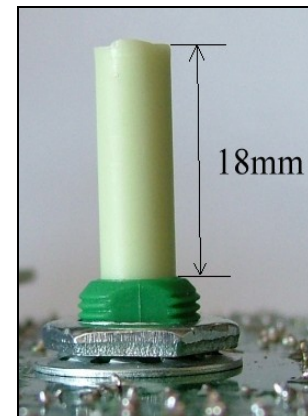

Before fitting VR1 and VR2 cut the shafts to required length, if using the suggested case the shafts need to be cut so that 18mm is left protruding above the mounting thread.

Note that shaft length will depend on the types of knobs used. Save the pieces of shafts removed so one can be used to later extend the tuning spindle. Fit from the component side and connect to the PCB with pieces of cropped component leads.



4k7 Linear potentiometer	
VR1	

10k Linear potentiometer	
VR2	

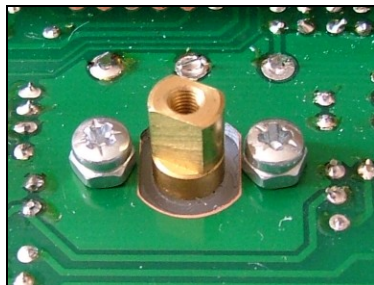

Fit the tuning capacitor using M2.5 x 6mm screws. NOTE: screws must have nuts fitted underneath their heads before fitting so as screw thread doesn't foul the capacitor vanes.

Dual gang Polyvaricon	
-----------------------	--

C57	
-----	--

Fit LED from track side and solder on component side, leave the leads long as the LED will require repositioning when the case is fitted. The longest lead is the anode (+) terminal.

3mm Red LED	
-------------	--

LED 1	
-------	--

Fuse 2A QB	
------------	--

F1	
----	--

## Initial testing

If necessary wire up the power, speaker, microphone and antenna leads as shown in section 16. Whilst testing it is best to power the MKARS 80 from a current limited 12 – 14V power supply, on TX a nominal current of about 1.3 Amps is required.

Before connecting power make a careful inspection of soldered joints especially for any solder splashes etc. At this point the micro-controller and display should not be fitted as these components can easily be damaged by wrong voltages applied to their pins. Measure between supply positive and ground with a multi-meter on Ohms range to ensure there is not a short circuit, typical values will fall in

the range 1k6 to 2k0. Note that if you reverse connect the meter IE red lead to ground and black lead to positive the reverse protection diode resistance will be measured. Make sure R2 is set fully anti-clockwise.

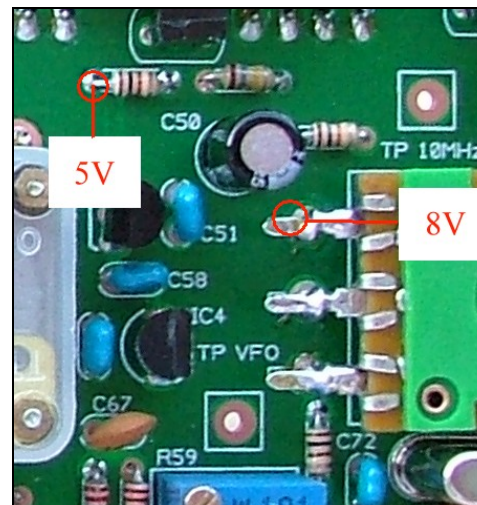

Connect the loudspeaker. Connect 12 – 14V and check for any obvious fault symptoms – loud noises or smoke! Assuming all is OK measure the 5V regulated supply at R34 (see photo), it should be  $5 \pm 0.25V$  and the 8V regulated supply at VR2 which should be  $8 \pm 0.4V$ . If either is incorrect remove power and investigate the problem before continuing.

Connect an antenna and advance the RF gain. Depending upon band conditions and the gain of the antenna there should be either stations or noise heard, the RF gain may need to be advanced fully clockwise to hear noise when the band is “poor”. If all is OK remove the power and fit the micro-controller.

PIC16F818-I/P	
---------------	--

IC2	
-----	--

Now install the display; firstly fit the display using a single screw in its top left hand corner – a M2.5 x 12mm screw is passed through from the PCB component side and held in place with a nut. On to this is screwed another nut, the display and finally another nut. Note that

the PCB spacers supplied are 12mm long this means the display MUST not be higher than 12mm above the PCB or it will be pressed against the case causing damage. When you are happy with the distance pass pieces of tinned copper wire through the display connections and push them into the socket strip beneath, the LCD should be moved so the **left** most holes align. Straighten the display (compare its top edge with the edge of the PCB) and solder them to the display. This will make the display pluggable which is desirable so soldered joints underneath can be accessed.

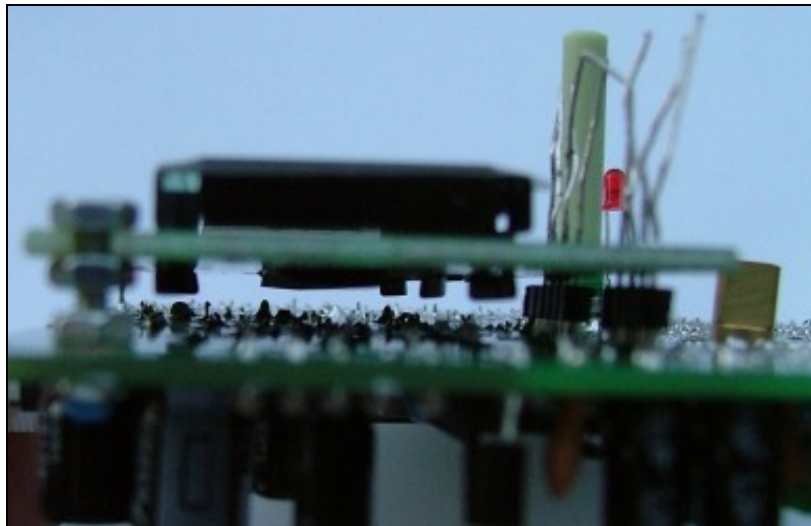

Look between the display and main PCB and confirm that there are no wires shorting between the two, you may wish to fit a cardboard or plastic insulating sheet under the display to guard against any accidental short circuits.

PC1602F LCD Display	
DISP1	

Re connect 12V and adjust R29 display bias – whilst monitoring the LCD display slowly turn R29 anti-clockwise until the background extinguishes leaving just the characters.

The display should first show a welcome message followed by the frequency and supply voltage.

### Alignment

Set the VFO frequency range; the UK 80M allocation is 3.5 – 3.8MHz. As viewed from the front (track side) turn the Polyvaricon (C57) knob fully clockwise (minimum frequency) and adjust C38 so

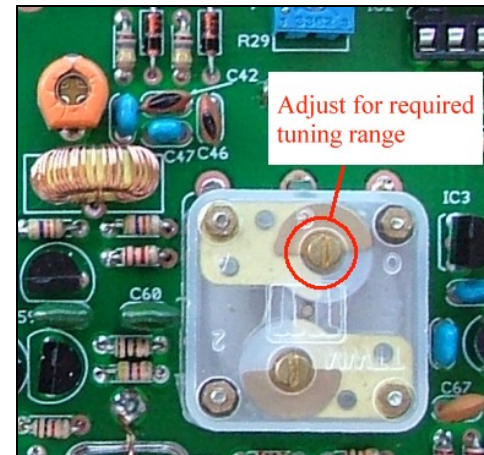

the frequency displayed is just a little lower than the lower band edge – 3.450MHz is suggested. Turn the Polyvaricon (VFO) to maximum frequency and check that it is possible to tune above the top of the band. If desired the total tuning range can be adjusted with a trimmer capacitor on the back of the Polyvaricon.

Moving the capacitor into mesh will reduce the range and moving out of mesh will increase the range – note that after adjusting this capacitor the frequency will need adjusting by C38.

C83 BFO – there are two methods of adjusting the BFO frequency, either are acceptable.

1. Using a frequency counter adjust C83 for a frequency of 10.000MHz measured at TP 10MHz.
2. Accurately tune to an SSB transmission on a known frequency and adjust C83 for a properly resolved signal.

C54, C68 and C79 band pass filter – the setting of these capacitors is not critical and may be set as shown in the photo.

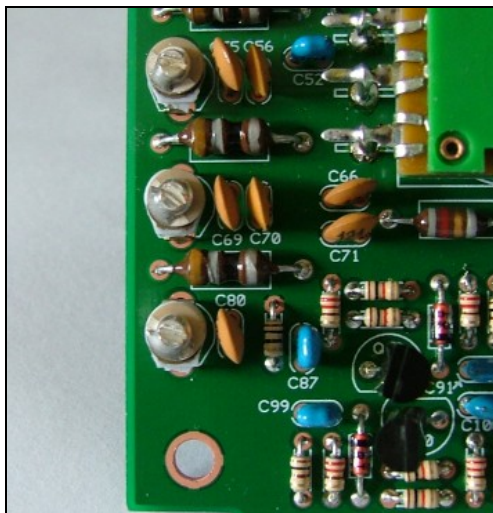

R2 PA bias current – disconnect the antenna and connect a dummy load suitable for 5 Watts.

Connect an ammeter in series with the radio and power supply capable of reading 3 amps. Whilst making this adjustment do not speak or make other noises into the microphone; press the PTT and note the current drawn. Adjust R2 for an increase of  $50 \pm 5\text{mA}$ . For

example, before adjustment (R2 fully anti-clockwise) the current was 230mA, in this example when correctly adjusted the current will be 275 – 285mA. Note as the components warm up that the current will rise – do not transmit for more than a few seconds if Q1 isn't fitted with a heatsink or it will overheat.

R59 and C103 mixer balance – connect a sensitive power meter and dummy load to the antenna connector. With power connected slowly insert the microphone / PTT plug until the transmitter is operated but not modulated by the microphone, alternatively plug in a stereo jack with all contacts grounded.

A small reading may be noted on the power meter, adjust R59 to reduce this to zero. There are two possible methods to further improve the mixer balance:

1. Tune in to the carrier with another radio and adjust R59 and C103 for minimum signal or “S” meter reading.
2. Connect an oscilloscope to the antenna connector and adjust R59 and C103 for minimum waveform, note that both these adjustments are inter-reactive (they effect each other).

## PCB Options

### Power switch

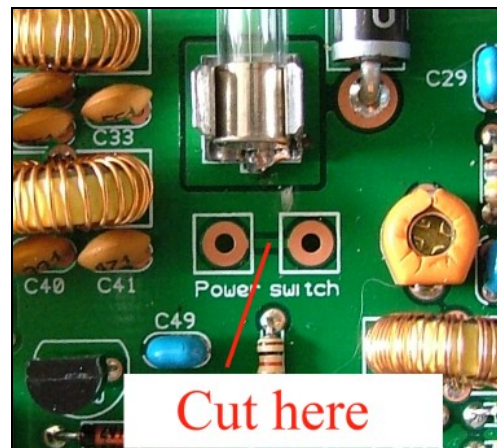

The PCB incorporates a facility for fitting a power switch, the RF gain control may be replaced by a switched 4k7 linear potentiometer and the power switch wired to the marked pads. For the switch to function the track needs to be cut with a sharp knife where indicated.

### Internal Loudspeaker

A small internal loudspeaker can be fitted, it is best to position this away from L5 to avoid the magnet de-tuning the VFO. Connections are provided for the loudspeaker (the polarity being unimportant), the internal loudspeaker will be disconnected when the external speaker socket is used.

## Internal battery

PCB pads are provided for connecting an internal battery if desired, the negative terminal is isolated when an external power source is

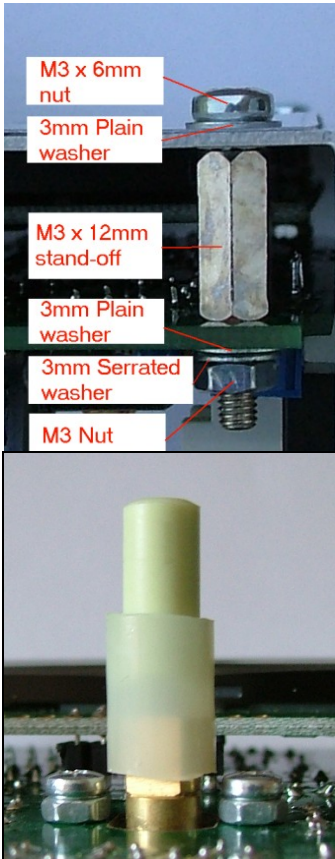

plugged in; note that there is no provision to recharge internal batteries.

## Boxing up

Fit 4 M3 x 12mm hexagonal spacers to the corners of the PCB, a flat and serrated washer should be fitted under each nut.

Cut the knob extension to length and fit to the tuning capacitor shaft, this is a short length of plastic air pipe, it allows one of the cut-off potentiometer shafts to be used to extend the Polyvaricon shaft. Don't force too much tube over the shaft as the pressure required could damage the capacitor.

A metal case must be used for screening and to provide Q1 with a heatsink.

Print out the drilling template and confirm the size is correct by measuring the printed dimensions. Stick the drilling templates to the outside of the case aligning the reference edges with the INSIDE surfaces of the box, this is important; for the templates to be universal no account has been made for case thickness, instructions are printed on the templates. Possible adhesives are PVA glue and double-sided tape.

Drill all holes to the sizes indicated on the template, use good engineering practice; start with a small drill and work up in size. Note the following:

- If the recommended case is being used the control shaft and BNC connector holes will need to be elongated to allow the PCB to fit.
- Ensure that when plugged in the DC connector outer contact can't touch the case.
- If the PA transistor-mounting hole doesn't align properly it is permissible to open the hole up slightly, if stressed the transistor legs will fail sometime in the future.

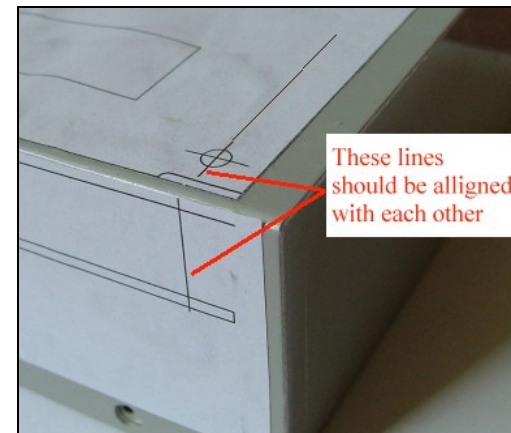

To cut the display window without special tools I would recommend drilling many holes close to each other just on the inside of the window then using a pair of side cutters join them up. The window can then be squared up using a file.

When all holes have been cut, trial fit the board to the case and if necessary re-heat the solder pads on Q1 (PA transistor) to align its mounting hole with that drilled in the case.

Note that when fitting the PA transistor into the case a heatsink washer and insulator must be used; place the insulator (no thermal compound is required) between transistor tab and case, fit plastic insulator through tab of transistor and into hole in case. Then fit an M3 x 10mm screw from the outside of the case and secure with flat washer, serrated washer and M3 nut; see photo.

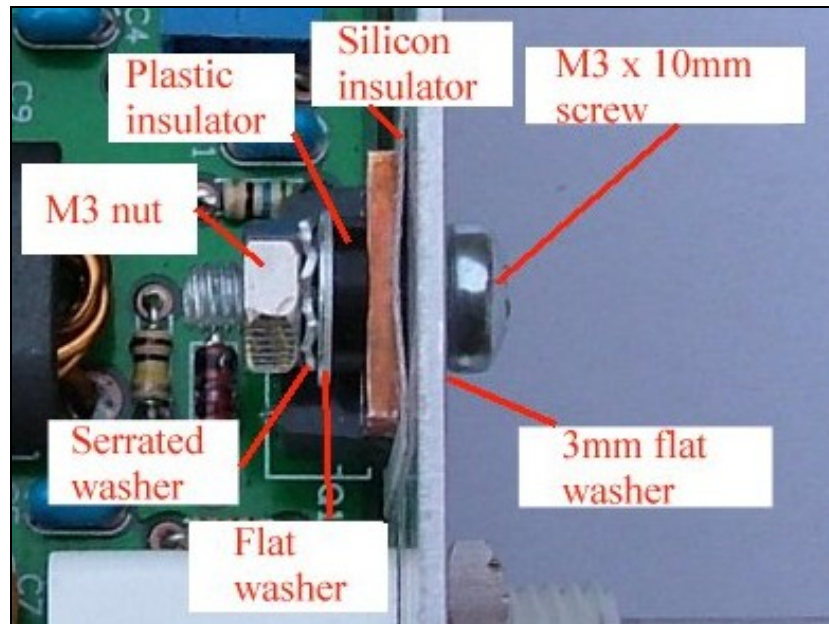

have catered for two methods of fitting a front panel; with a little thought I'm sure there are many more. For those wanting to design their own front panel critical hole dimensions and spacing are given on the drilling template.

1. A PDF file of a front panel is provided, this may be printed and glued (double sided tape perhaps) to the front and then covered with a sheet of acetate / overhead projector film trapped under the four fixings screws.

2. A negative image is provided, this can be printed on to acetate or a bubble jet transparency, by reversing the image the non-printed side is nearest the user so protecting the writing.

The builder is encouraged to personalise the front to their own taste to add some individuality.

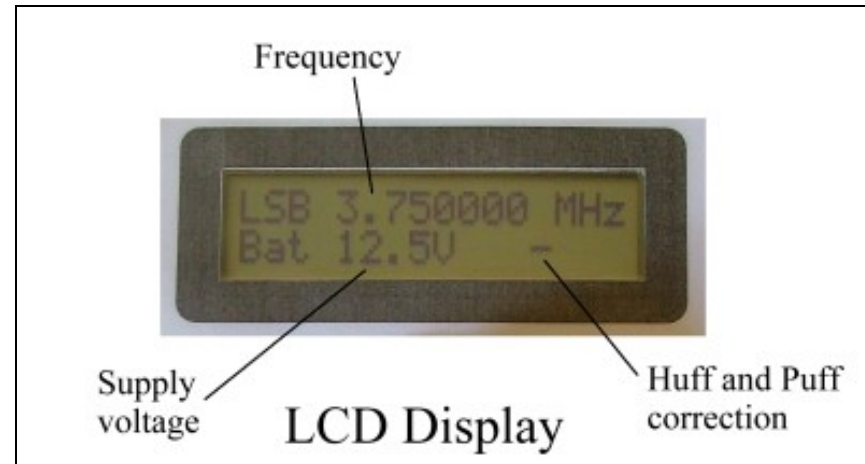

The PCB is secured in place by 4 M3 x 6mm screws with flat washers under the heads. Secure the BNC to the case using the serrated washer and nut supplied. Fit three knobs as required, note the shafts are 6mm in diameter.

### Final air test

Attach an antenna and arrange a contact with a local amateur on the 80M band to confirm the radio operates as expected.

### In use

Firstly it should be remembered that the MKARS80 is low cost and of a relatively simple design, its functionality cannot be compared with a complex commercial transceiver! That said great enjoyment can be had if its limitations are realised.

After powering on best frequency stability isn't reached until the temperature within the case has stabilised, the Huff and Puff circuit will keep the radio on tune in the short term but may need adjusting a few times during the warm up period.

### Tuning

The VFO is capable of covering the whole UK 80M allocation but due to the VFO frequency being below that of the IF the tuning works backwards. I.E. clockwise rotation decreases the tuned frequency. Once the approximate frequency has been tuned with the main tuning control the fine tune control may be used to get within  $\pm 5\text{Hz}$  of the wanted frequency.

It will be noticed that the Huff and Puff circuit will try to hold the frequency as you adjust the fine tune control, this "hold" will be broken when the actual frequency is more than about 100 Hz different from that displayed. Once the lock is broken there will be a delay of 3 seconds before the Huff and Puff again tries to hold the frequency steady.

The Huff and Puff circuit is able to compensate for about  $\pm 1.5\text{kHz}$  frequency drift; the bar to the right of the battery voltage graphically displays any error between displayed and actual frequency. If this tuning bar reaches either of the extremes the VFO should be re-adjusted. Remember that if the displayed frequency is more than about 100Hz different from the VFO frequency the Huff and Puff circuit will stop attempting to correct the drift and there will be a sudden change in tuned frequency.

### RF Gain

The RF gain control determines how much signal is applied to the receiver, this has the same effect as adjusting the AF gain (volume)

control on a conventional radio. As this simple design doesn't incorporate an AGC circuit the control has to be adjusted for a comfortable listening volume and may need adjustment between different stations in a QSO.

### **WARNING**

***Be careful when using headphones as volume is dependent on strength of received signals and at the very least this could "surprise" the operator when tuning through a local station!***

### Modulation indicator

This LED extinguishes at about the point the PA transistor saturates; running the output transistor into saturation can cause "splatter" across adjacent QSOs. Splatter is actually intermodulation and is caused by the output stage becoming non-linear and mixing frequencies within the wanted spectra causing nearby unwanted signals. Whilst transmitting the indicator should momentarily extinguish on voice peaks.

### Fitting Plugs and sockets

#### Power connector – 2.1mm DC plug

These are available in two lengths, either is suitable with the case recommended but the "long" type may be required if the case has thick walls.

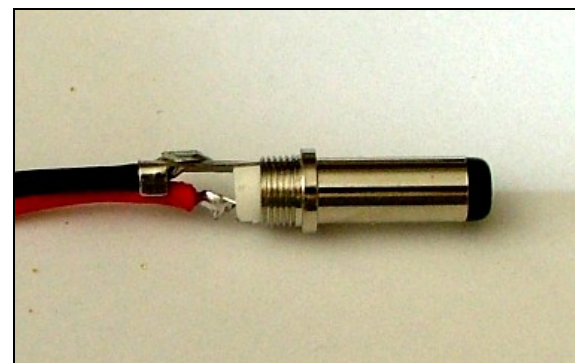

It is very wise to use colour-coded lead (red and black) to avoid any accidents! Use a lead suitable for carrying 2 amps; if running from a battery it would also be



sensible to fit an in-line fuse – the PCB mounted fuse is designed to protect the radio not the power supply / lead.

Remove the connector cover and slide over both leads. Solder the positive (+) lead to the center contact and negative (-) to the outer contact and strain relief, when cool carefully crimp the strain relief over both wires and fit the cover. Measure the continuity of both leads through to the plug contacts and confirm there is no short circuit between inner and outer.

**Loudspeaker plug – 3.5mm mono jack**

Firstly remove the plug cover and slide over loudspeaker leads. Solder one connection to the centre contact and the other to the outer contact / cable grip, when cool carefully crimp the cable grip around both wires to help give some strain relief. Wire size isn't important as currents flowing to the loudspeaker are small, polarity of wires is unimportant.

**Microphone / PTT plug – 3.5mm Stereo jack**

Use has been made of very low cost electret microphones designed for PC multi-media use; these generally come with a stereo 3.5mm jack plug. Remove the jack plug and rewire to a new stereo 3.5mm jack along with a PTT switch, the switch should be a push to make type.

As with the loudspeaker connector remove the plug cover and slide over the microphone and PTT switch leads, then solder the wires to connector solder tabs as follows:

- Plug tip – Microphone +
- Middle contact – PTT switch
- Outer contact – Microphone and PTT ground

When the soldered joints have cooled, the cable retainer should be carefully crimped over all wires and the cover screwed in place.

Note that a DC bias is provided on the microphone input by R17, if the user insists on using a dynamic microphone this resistor should be removed.

**BNC connector**

The connector shown here is a typical low cost BNC type.



Over the cut end of RG58 coax slide the clamp nut, washer, and seal. Strip the sheath off over-long (approx. 15mm) and slide on the tapered collet.

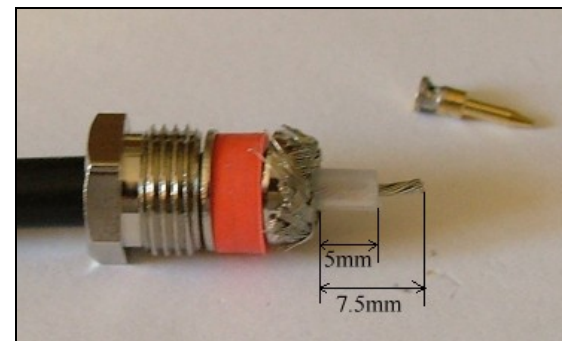

Pull braid back over tapered collet and trim; trim the inner conductor length to 7.5mm and then strip the dielectric to 5mm in length.



Fit the inner contact and solder through small hole.



Fit body and tighten clamp nut, finally check that there is no short circuit between inner and outer contacts and that inner contact is in correct position.

### Component identification

Components have been packed in to 6 bags, the contents of these bags and order of assembly have carefully been chosen so similar components shouldn't become confused.

For fault finding it will be necessary to correctly identify components and their values after the radio has been built; methods of marking component values are given.

### Capacitors

Most of the small value capacitors (ceramic and Mylar) used in this kit are marked in one of the following ways.

- Marked directly with their value, for example 8 for 8pF and 68 for 68pF.
- Marked numerically based in Pico farads, the first two digits are the value and the third is the multiplier, for example 1nF (1000pF) is marked 102 (1, 0 and two zeroes), 220pF is marked 221 (2, 2 and one zero).

Electrolytic capacitors are marked directly with their value.

### Resistors

Values on all the resistors in this kit use a colour code to indicate value.

Two resistors used in the battery voltage measurement circuit (R21 – 12K and R23 – 33K) are 1% tolerance types and are therefore marked with 5 coloured bands; all other types have standard 4 band markings.

Colour	Value	Tolerance
Black	0 ×1	
Brown	1 ×10	1%
Red	2 ×100	2%
Orange	3 ×1000	
Yellow	4 ×10000	
Green	5 ×100000	
Blue	6 ×1000000	
Violet	7	
Grey	8	
White	9	
Silver	Divide by 100	10%
Gold	Divide by 10	5%

Examples:

1kΩ 5% (1000Ω) = Brown (1) Black (0) Red (×100) Gold (5% tolerance)

2R2 5% (2.2Ω) = Red (2) Red (2) Gold (divide by 10) Gold (5% tolerance)

Note that 1000Ω = 1k, 1000000Ω = 1M, 2K2 = 2200Ω, 2R2 = 2.2Ω etc.

**Inductors**

Axial inductors use the same colour code as resistors with their value based in micro Henries; for example 8.2uH is marked Grey (8), Red (2), Gold (divide by 10) and Silver (10% tolerance). All inductors used are significantly larger than resistors so are unlikely to be confused; axial inductors only have one failure mode – open circuit, which can easily be identified with a multi-meter set to measure resistance.

**Diodes**

All diodes used are axial and have their cathode end marked by a "band" on the encapsulation.

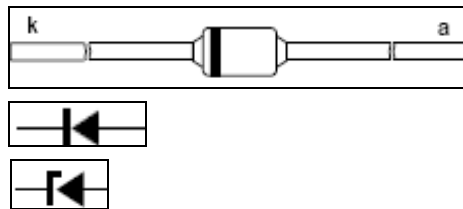

Values are marked on the bodies although for the small glass diodes (zener diodes and 1N4148 types) they will be hard to read without a magnifying glass.

**Transistors and Ics**

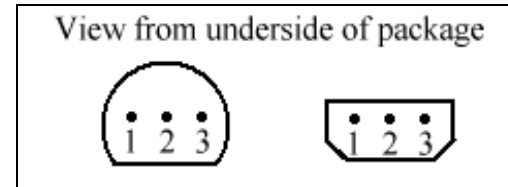

TO92 and E-line terminal identification			
Component	Lead identification		
	1	2	3
BC337	Emitter	Base	Collector
BC547	Emitter	Base	Collector
MPSH10	Collector	Emitter	Base
ZTX651	Emitter	Base	Collector
78L05	Input	Gnd	Output
78L08	Input	Gnd	Output

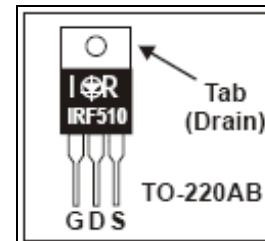

IRF510 FET terminal identification.

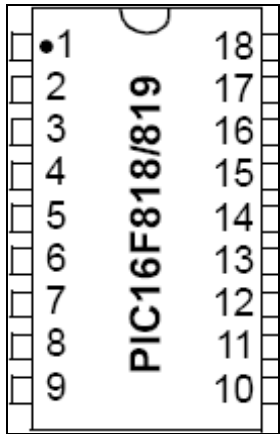

LM386 is similar to PIC16F818 but only has 8 pins.

### Fault finding

Most faults are due to poor soldered connections or components misplaced, it is very rare to be supplied with a faulty component. Before making any measurements look carefully for any poor soldered joints, short circuits or incorrectly fitted components.

Should fault finding be necessary a table of voltages is given below, transistor voltages were measured both in transmit and receive.

## Voltage tables

Transistor	Receive			Transmit		
	Gate	Drain	Source	Gate	Drain	Source
Q1	0	13.8	0	3.4*	13.8	0
	Emitter	Base	Collector	Emitter	Base	Collector
Q2	0	0	0	0	0.63	4.4
Q3	0	0	0	0	0.73	0
Q4	0	0	0	3.7	4.4	12.3
Q5	0	0	0	1.6	2	12
Q6	0	0.65	0.65	0	0.65	0.65
Q7	0	0.39	2.2	0	0.39	2.2
Q8	0	0.57	2.2	0	0.57	2.2
Q9	0	0	0	2.4	3.2	11
Q10	0	0	0	2.8	3.4	3.8
Q11	3.6	3.6	7.5	3.6	3.6	7.5
Q12	3	3.65	7.5	3	3.65	7.5
Q13	4	4.65	9.4	4	4.6	9.3
Q14	0	0.62	4.4	0	0	0
Q15	2.2	2.8	9	0	0	0
Q16	3.9	4.1#	7.2	3.9	4.1#	7.2
Q17	3.75	4.4	12.8	0	0	0
Q18	4.2	4.3	7.2	4.2	4.3	7.2
Q19	3	3.7	7.6	0	0	0
Q20	0	0	0	2.9	3.7	7.50
Q21	0	0	0	2.1	2.8	9
Q22	0	0	0	2.5	3.2	10.2

IC number	Pin number																			
	1	2	3	4	5	6	7	8	9	10	11	12	13	14	15	16	17	18		
IC1	1.4	0	0	0	7	13.8	7	1.4												
IC2	4.9	0	0	0	0	5	0	0	2.5	4.9	4.9	2.2	4.9	5	-0.3	2.2	3.7	0		
IC3	13.8	0	5	All IC pin voltages are similar during transmit or receive																
IC4	13.0	0	8																	

Notes:

- Value will depend on setting of bias control
  - # Measuring this point can affect circuit operation leading to false readings
- All measurements were made with RF gain at minimum and no modulating audio

# Block diagram and circuit description

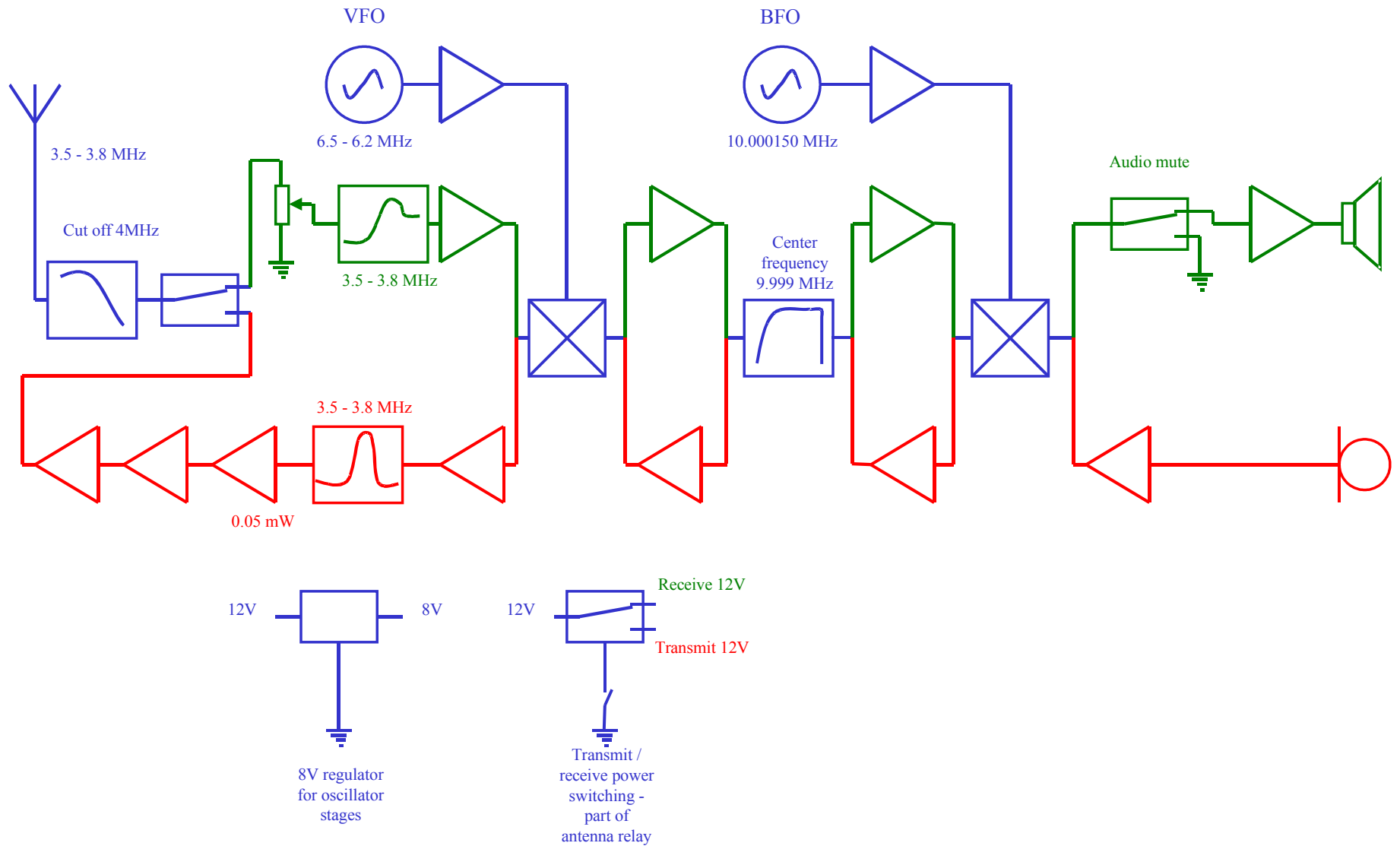

The radio uses a single IF super-heterodyne architecture with several so called bi-directional stages. These allow the sharing of all the main functional blocks between transmit and receive – mixers, IF filter VFO and BFO.

### **Receive signal flow**

The receive signal passes through the transmit low pass filter, the switching relay, RF gain control and then through a high pass filter; in this way a receive band pass filter is not required. Filtered an attenuated signal is then amplified and presented to a double balanced mixer constructed from discrete components, this mixer is also shared with transmit. By mixing the received signal with 6.5 – 6.2 MHz from the VFO an IF of 10 MHz is generated. Note that the VFO works backwards, a 3.5 MHz tuned frequency requires a VFO frequency of 6.5 MHz and a tuned frequency of 3.8 MHz requires a VFO frequency of 6.2 MHz.

The amplified IF signal is then filtered by a 4-pole crystal filter at 9.999 MHz before again being amplified and presented to the BFO mixer. When the IF signal is mixed with the output from the BFO an audio signal is produced, this is then amplified and supplied to the loudspeaker. A mute circuit operates in transmit to avoid feedback between microphone and loudspeaker.

### **Transmit signal flow**

Audio from the microphone is first amplified and then fed to the BFO or carrier insertion oscillator, the frequency spectra generated is first amplified and then filtered by the IF filter shared with the receiver.

Amplified IF signal is presented to the main mixer where it is translated to the output frequency again amplified and then filtered by the band pass filter. Three more stages of amplification follow before the signal is passed through the transmit / receive relay then through the low pass filter to the antenna.

### **Frequency display and “Huff and Puff”**

A micro-controller “counts” the VFO oscillations with a 40mS time base derived from the BFO, a correction voltage is also derived from the comparison of the counted down VFO input and the internally generated 40mS time base. The correction voltage is generated by an internal PWM (pulse width modulator) and after filtering is applied to a varicap diode (actually a zener used as a varicap) in the VFO section.

An A/D input of the micro-controller is used to measure and indicate supply voltage via the LCD display.

# Circuit Diagram

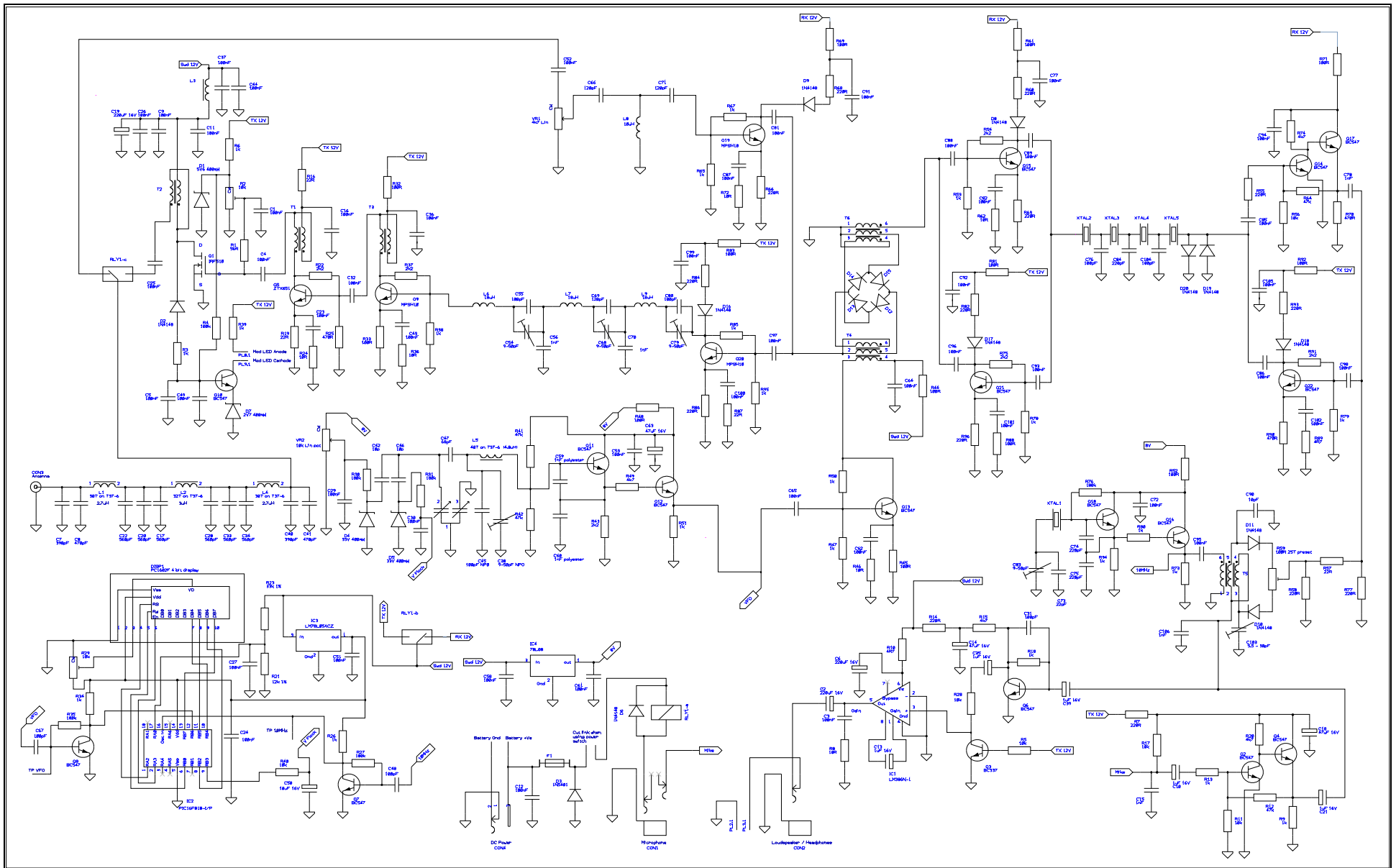



# PCB overlay

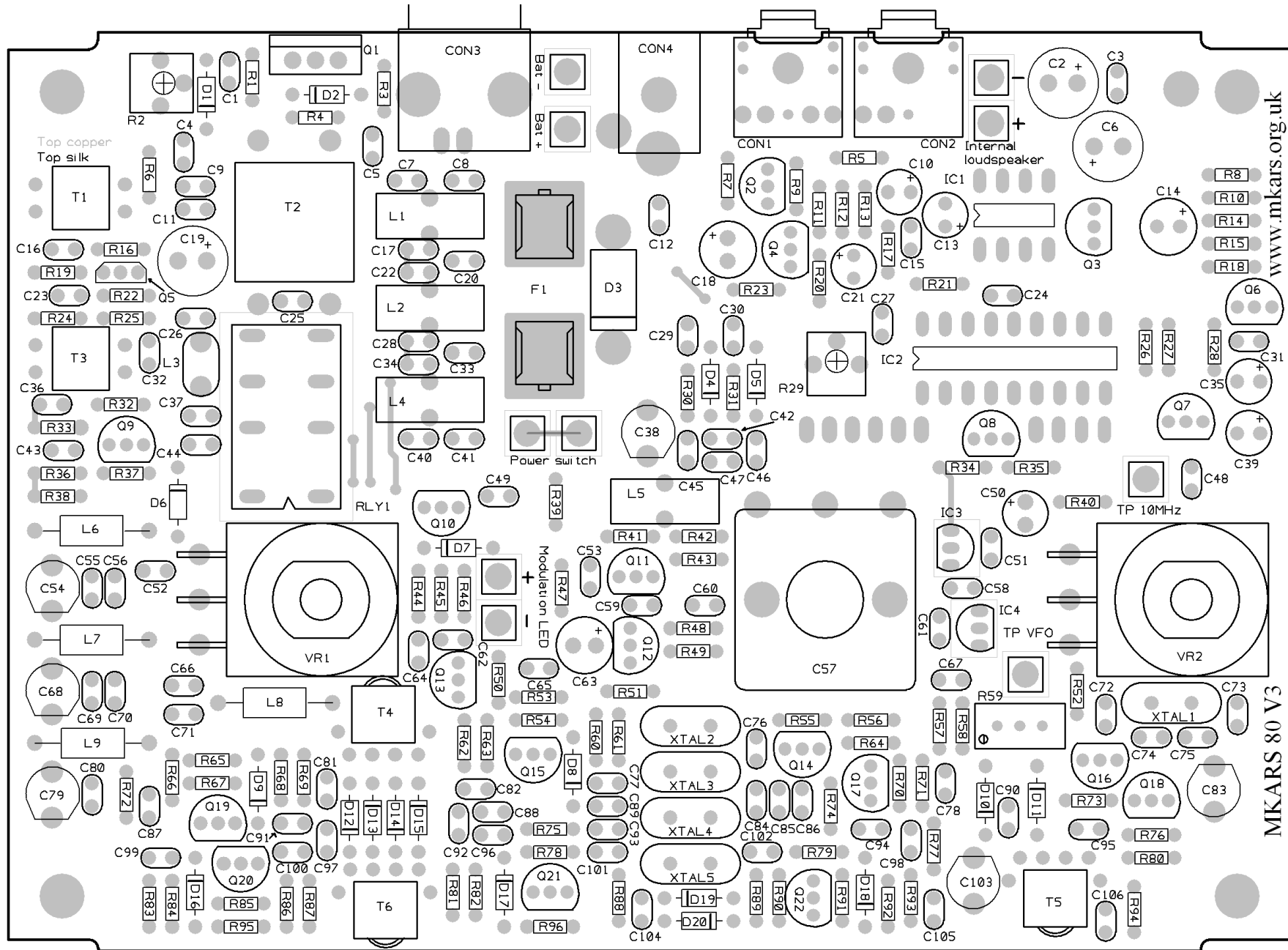

www.mkars.org.uk

MKARS 80 V3

Version	Changes
12-05-07 V1.0	First release
15-06-07	Voltage reading on pin 8 of IC1 corrected (thanks to Tom G3LMX)
	C42, C46 now 10pF, L8 now 10uH – Component value changes required due to availability
	T1 and T3 shown as 2T+2T, should be 5T+5T
05-10-08	Moved position in manual for adjustment of R29 LCD bias voltage – previously positioned at end of alignment instructions
	Modify fitting LCD – left most holes are used
	Adjustment of bias current R2 – changed measurements in example to be more realistic
	Schematic – Corrected connections on microphone socket in line with PCB (no PCB changes)
02/01/09	Change capacitors types of C59 and C60 to improve VFO stability ready for CW adapter – notes updated accordingly
	Firmware upgraded to V2.0 – improvement in “useability”