

**Assembly Manual**  
**ME30+**  
**30 Meter CW Superhet**  
**Transceiver Kit**

Version 0.1na

March 11, 2022

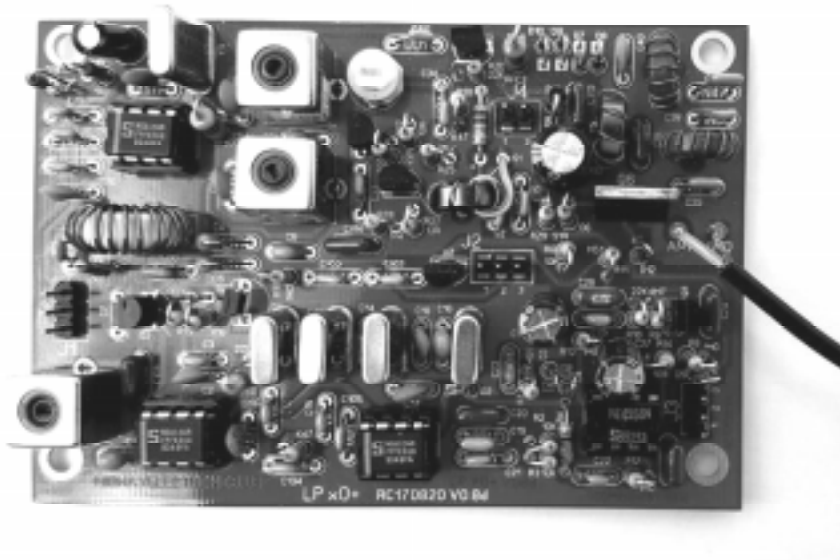

**Midway Electronics**

7714 Main St.  
Middletown, VA 22645

540-313-8040

**midwayelectronics.us**

email: [midway7726@gmail.com](mailto:midway7726@gmail.com)

**Thanks!** For purchasing one of the Midway Electronics “ME30+” transceiver kit. This kit is an updated version of the classic ‘40-40’ transceiver board which originally appeared in the November 1994 issue of QST and the SW-30+ from Small Wonder Labs and Dave Benson.

Please take a few moments to look over the section entitled “First Things First” on Page 3. This is background information in case you’re fairly new to homebrewing or kit building. Also please study the addendum at the end of this manual, sheet contained in the kit, and the latest addendum on the website [midwayelectronics.us/qrp/addendum.htm](http://midwayelectronics.us/qrp/addendum.htm)

## Specifications

Power requirements: 11-14VDC diode protected.  
Power consumption: 20ma Receive, 290 ma @12.5 V for 1.9 watts  
Receive sensitivity: 0.5uV for 5-9 signal, 0.033uV (-135dbm) copyable CW  
Band: 10.10 mhz to 10.260 mhz capacitor selectable  
Tuning range: ~ 30 khz  
RF output: 0.1 to 2 watts adjustable  
2nd harmonic: -42 db below carrier  
3rd harmonic: -50 db below carrier

## TABLE OF CONTENTS

First Things First .....	3
Materials.....	4
Schematic.....	6
Theory of Operation .....	7
Building Instructions.....	8-11
Mechanical Details.....	12
Alignment .....	13
Checkout .....	14
Troubleshooting the ME30+ .....	14
Troubleshooting Voltages.....	17
Parts List.....	18-19
Parts Layout.....	20
Appendix .....	21
Addendum .....	22

## TOOLS

You'll need the following tools:

- Soldering iron – 25-40W, solder
- Diagonal cutters
- Needle-nose pliers
- Small slot screwdriver
- Magnifying glass (mandatory)

## TEST EQUIPMENT

You'll need the following:

- DC power source – 12-14V @ 500mA min.
- Multimeter
- Another transceiver (for final adjustment)
- Frequency counter (helpful but not essential)

**First Things First** - what you should know:

You don't need to be an expert in all phases of this craft, but you should be comfortable with the basics before you embark on this adventure.

### ● COLOR CODES:

You should be familiar with the standard color code markings on resistors. If not, visit:

<http://www.midwayelectronics.us/qrp>

for a link to color codes. If you're still not sure, verify the resistor values with an ohm meter. Resistor color codes are given in the parts list.

👉 Approximately 8% of the male population is red/green colorblind. If you're one of these, you should be verifying all resistors with a meter before installing them.

Please read the Addendum on Page 22 for more important suggestions.

👉 The ME30+ board is double-sided, and all holes on the board are plated-through. This means that you do not need to solder on the top side of the board.

### ● SOLDERING SKILLS:

Hopefully this isn't your first experience with a soldering iron. If it is, though, or this is your first solid-state project, here are some tips to ensure your success:

- Use a temperature controlled soldering station or small soldering iron in the 25-watt class and keep the tip clean. Use a moistened sponge or paper towel and clean the tip periodically as you work.

- Apply only as much heat as is needed to get a good joint. A small vise can hold the circuit board to make soldering easier.

- Touch the soldering iron tip to the PC board trace and the component lead simultaneously. Within a second or two, apply solder and you'll see the solder flow onto the junction. Withdraw the solder and then the soldering iron.

- Avoid the temptation to load solder onto the joint until no more will fit. This is an invitation for trouble, as solder bridges may form across the closer trace separations. Here's what the correct and incorrect joint treatments look like:

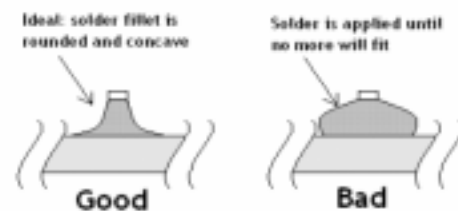

PLEASE READ THE SECTION BELOW FOR REMOVING ANY PARTS FROM THE CIRCUIT BOARD.

 Use a roll of desoldering braid. Lay the end of the braid down on the joint to be cleaned and press the soldering iron tip over the braid. Within several seconds you'll see the braid begin to wick up solder from the joint. Remove the braid and reapply a new section as needed until the joint is clean. It may be necessary to pull the component out from the top side of the board while heating the joint. Leave the iron tip on the board only as long as necessary to do the job – the PC board traces will eventually delaminate (peel off) if overheated.

If that still doesn't do the trick, it may be necessary to cut the offending part off on the top side and pull the remaining leads through with pliers. Contact Midway Electronics for replacement parts if necessary.

 After removing a component from the board, the through-hole will probably still be blocked with solder. Use another piece of solder wick or a dissecting needle, dental pick (explorer), or even a large sewing needle, applying heat to the needle and board trace simultaneously until the tool pushes through.

 If you have a solder sucker you can suck out the solder off the pads on the device you are trying to remove.

## Materials

You'll find the following items included with your ME30+ kit:

- 1 bag of small parts (resistors, caps, etc.)
- 1 antistatic bag (semiconductors)
- 1 bag, miscellaneous parts
- 1 printed circuit board
- This manual

Each component is uniquely identified by a refer-

ence designator.

Check the contents of all the parts bags with the list in the Appendix. Contact Midway Electronics by email only should you have a missing part..

 You may want to reproduce the schematic and pictorial pages so you can mark them up as you work, and still keep the originals clean. If you need extra copies of this manual, schematics or layout, please visit:

<http://www.midwayelectronics.us/qrp>

**Please do not neglect to study the latest assembly notes and hints on the website above.**

## Special Parts Notes

**Reference designators:**

If 3 digits are printed on the capacitor, the first two are significant figures and the third is a multiplier.

$$'471' = 47 + 1 \text{ zero} = 470 \text{ pF}$$

$$'103' = 10 + 3 \text{ zeros} = 10,000 \text{ pF} = .01 \mu\text{F}$$

If a letter follows it denotes tolerance: J=5%, K=10%, M=20%.

A detailed explanation of code letters and numbers are located on the above referenced website.

**“C7”:**

Capacitor C7 is an assortment of 6 different capacitors designated 'C7A' through 'C7F'. Selection and installation of this capacitor is described on page 12.

**Monolithic capacitors:**

Printing on these parts is tiny. Use a magnifying glass to verify component values before installing them.

### RF Chokes:

Some may have color bands and some are marked in plain text. The order of the color-bands on the RF chokes may vary by manufacturer.

### IF Transformers:

Although not illustrated on the schematic drawing for reasons of drawing clarity, T1-T3 contain internal capacitors for the 30 meter band. Do not disturb these capacitors in the base of the transformers.

### Lead spacing:

All capacitor hole spacings are either 0.1 or 0.2 inches wide. Due to the variation of lead spacing from manufacturer to manufacturer it may be necessary to bend the capacitor leads to get them to fit in board. You must use a pair of needlenose pliers and carefully bend the leads. Be careful not to stress the leads too close to the body of the capacitor or you may break the capacitor or leads. Capacitors should easily slide into holes.

### Winding Toroids:

 Count as you go. Draw each turn snug against the core to ensure a trim and tight winding. Ensure that none of the turns is wound “over” (on top of) its neighbors. Do not kink the wire. You can spread the turns evenly after completing the winding.

 Double-check the turn count when you’re finished. Use your fingernail or a small screwdriver to “bump” over each turn as you count – this is much easier than counting by eye.

Trim the wires to about 1” and carefully strip the insulation off starting near the toroid and about a 1/2” with a hobby knife without nicking the wire.

 If the wire passes through the toroid center hole, it counts as a turn.

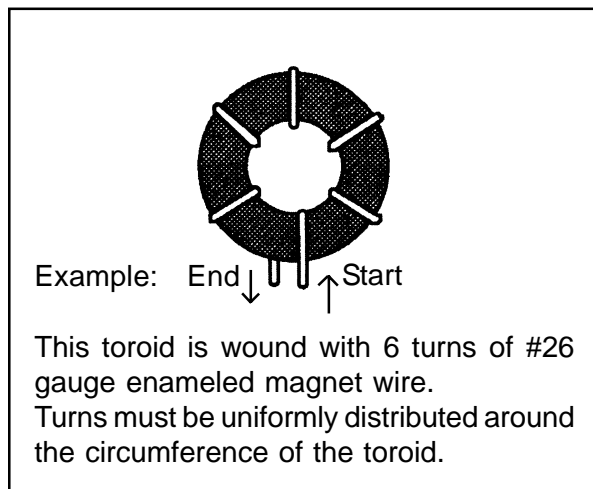

Your kit contains a bag of toroids and wire. There should be one large yellow toroid, two grey toroids and two small yellow toroids. There should be one length of #24 ga. magnet wire, 61 inches (155 cm) long. Leave other items in bag until needed.

Cut wire to the following lengths:

- 1 length 24 inches (61 cm) long
- 1 length 7 inches (18 cm) long
- 2 lengths 11 inches (28 cm) long
- 1 length 8 inches (20 cm) long

Wind the toroids using the following table:

- L1 Yellow T50-6, 28 turns using a 24 inch (61 cm) length of #24 ga. wire.
- L2 Grey FT37-43, 6 turns using 7 inches (18 cm) of #24 ga. wire.
- L3, L4 Small yellow T37-6, 15 turns using 11 inches (28 cm) of #24 ga. wire.
- T4 Grey FT37-43, 8 turns using 8 inches (20 cm) of #24 ga. wire.

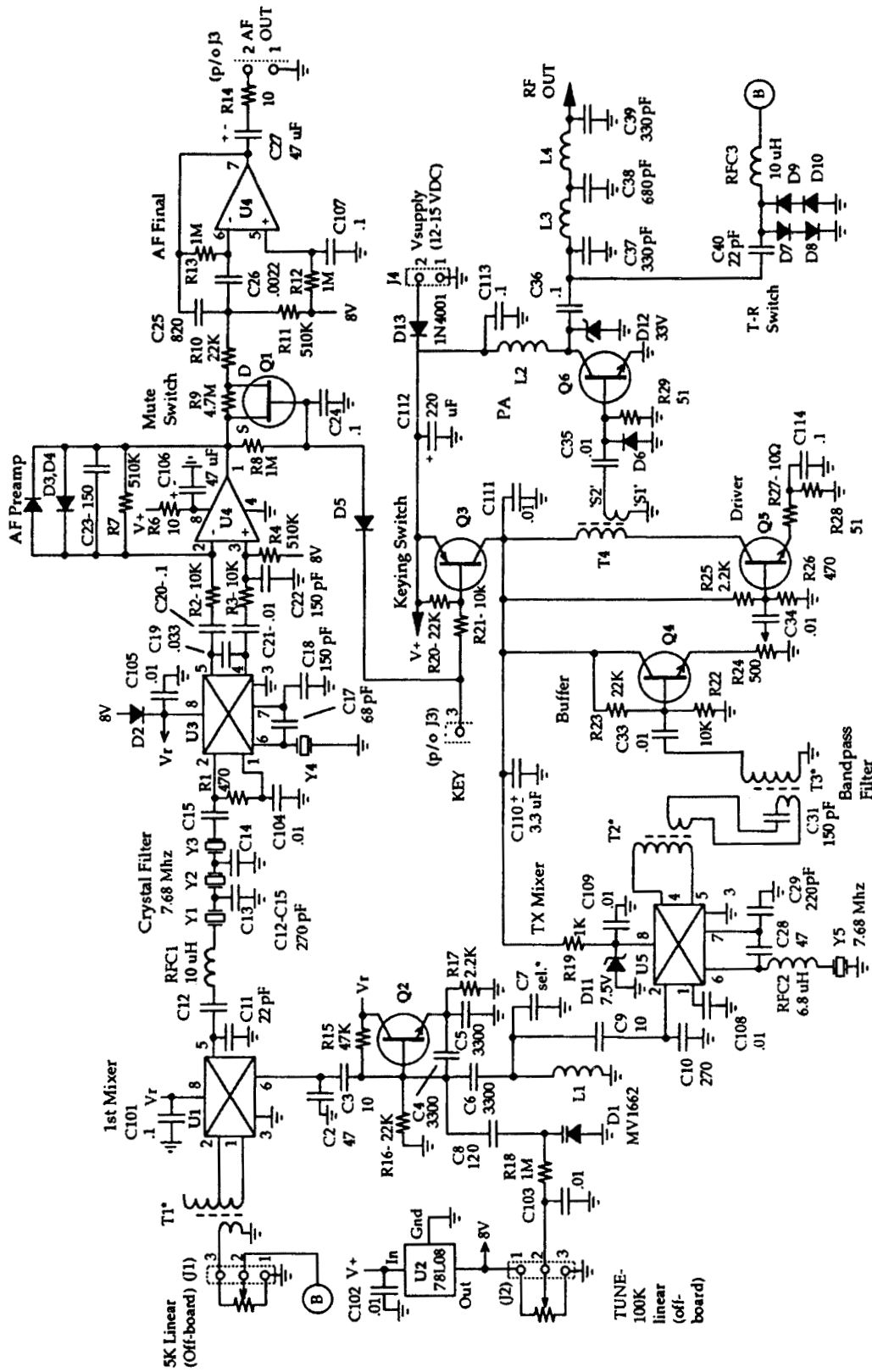

In the 30 meter version leave the internal capacitors in T1-T3.

## The ME30+ Transceiver

## Theory of Operation

This transceiver is a single PC-board design measuring 2.8" x 4.0" (7 x 10 cm). It features VFO operation with a 35 KHz tuning range, as well as QSK (full break-in) operation. Let's take the 50-cent tour:

The receiver's RF input is applied to U1 through T1 and C1, which provide a bandpass filter tuned to 10.1 MHz. T1's secondary winding provides roughly unity gain into U1 to minimize overload (IMD). U1 provides about 13dB of gain in this configuration, and converts the RF input to the IF frequency of 7.68 MHz. The L-network (C11 and RFC1) following the mixer serve to step the mixer output impedance down to the crystal filter's design value.

The crystal filter itself uses 3 crystals. Loss through the filter is less than 2dB, and with the component values as shown, the minus 6dB bandwidth is about 700Hz. Despite the filter's low parts count, performance is adequate when combined with the AF section's selectivity. The unwanted sideband image is down about 30dB at the audio chain's 800Hz peak response frequency.

The filter output is terminated in a 470 ohm resistor at the input to U3, the product detector stage. U3 converts the 7.68 MHz IF signal to audio and contributes another 13dB of gain. BFO crystal Y4 has been selected to match the IF filter frequency, so there's no BFO frequency trimming needed. The .033 uF capacitor across pins 4 and 5 of U3 provides the first measure of audio low-pass filtering.

The two sections of U4 each provide roughly 30dB of amplification. The first section is configured as a differential amplifier to make use of U3's differential output and rolls off the audio response above 1.5KHz. Diodes D3 and D4 serve to limit the audio swing during transmitter key-down to reasonable values. Without these diodes, this stage saturates and upsets the operation of the following FET switch section.

The AF mute function is the familiar series FET switch popularized by W7EL. Despite its relative simplicity, it's hard to beat this circuit for click-free audio switching. In the "key-up" condition the FET is zero-biased and acts "like a resistance of several hundred ohms. In the "keydown" condition the FET is in cutoff (because the gate is now 7-8 volts below the source) and acts like an open circuit, preventing audio from getting to U4B, the audio final stage. This stage is configured as a bandpass filter centered at 800Hz. The high gain of the two NE5532 stages (64dB total) allows a design with no IF amp stage. The audio output level is adequate to drive headphones, but it won't do the job for loudspeaker applications. The AF output stage internally overcurrent-limits on loud signals to provide a ready-made ear protection function. If you're interested in saving at least 5 milliamps on receive, U4 may be replaced by an LMC662. This suggestion is courtesy of Mitch Lee and Dennis Monticelli, from their excellent article, "Revisiting the 40-40" in the ARRL's 'QRP Power'. *Use good quality low-impedance headphones for best results. "Walkman" headphones are fine, but remember – you get what you pay for. The 3-dollar bargains are distinctly inferior!*

QSK: The T-R switch function is provided by C40 and RFC3, which form a series-resonant circuit. Diodes D7- D10 limit during key-down and thereby restrict the signal levels presented to the receiver front-end during transmit. *The double-diode configuration raises the network's intercept point with respect to W7EL's original configuration to improve IMD immunity.*

The LO uses the Colpitts configuration. The frequency determining capacitors are NPO (C0G) monolithic types. These devices are extremely compact and offer good temperature stability. C2 and C3 are a voltage divider providing proper injection to U1. *Note: If you want broader frequency coverage, the value of C8 may be increased. The useful upper limit for C8 is about 1000pF, and especially at the larger values, capacitor (and varicap diode D1) thermal stability will become crucial. Use NPO/C0G capacitors if possible, if you tinker with this circuit.*

The design also uses a varicap tuning diode for tuning coverage. While a smooth ball-bearing tuning cap and vernier reduction drive are the preferred approach, that choice drives the cost and mechanical complexity of a transceiver up considerably. The varicap approach supports quite a compact package! If you've just got to have RIT, an outboard circuit that injects an adjustable DC offset into the diode bias network on receive does the trick.

The transmitter chain is a pretty standard affair. The maximum output power is about 2 watts, and there's a drive control at the emitter follower stage (Q4) to adjust the output level. The diode at the base of Q6 serves to 'clamp' the signal to Q6 above ground and thus improves drive to the PA by several dB. *I don't feel that the PA requires a heat sink at the 1.5-2.5W power level and CW duty cycles. If you like, there's room for a 'compact'-style TO-220 heat sink.*

This rig complies with the FCC requirements for spurious emissions. All harmonics were down at least 34 DB. The largest spurious output was down at least 46 db if built as per this manual.

Note: The basic board kit contains all the parts on the board only. The controls, jacks, knobs, wire and headers are part of the Enclosure Option. Some hams will want to customize the enclosure to their liking.

## Building instructions:

- All parts installed on the PC board should be fully seated. Do not install the parts in "flying-lead" fashion in the hope that it will improve something-or-other! Minimum lead length is important to a successful RF design.

- **Diode installation:**

All diodes except D1 are bent for "upright" installation. Installation polarity is as shown below. Be sure to note the orientation of the silk-screened circle on the board and install the diode body over

this hole. The cathode (banded) end of the diode is oriented at the top and placed in square pad.

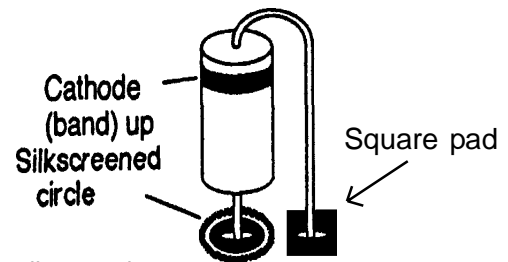

Leave small space between this pad and body of resistor or diode.

- **Resistor installation:**

All resistors except R4 and R21 are likewise mounted in "hairpin" fashion. As with the diodes, try to match the mounting orientation shown on the drawing. (This usually has nothing to do with critical dimensions – if mounted as shown you've got better troubleshooting access to circuit points from the top side of the board.) Orientation of resistor (and other non-polar devices) color bands is non-critical but looks professional.

- **Installing IC sockets:**

The "notch" or dot at one end should be oriented as shown in the picture on Page 15. *Double-check orientation before soldering. A suggestion: solder down two opposite corners of each socket, and then go back and press a fingertip on the socket from underneath while reheating both connections in turn. You may then solder the remaining pads. This precaution ensures that the socket is well seated on the PC board.*

- **Some additional tips:**

*It's helpful to work from one end or corner of the board to the other. This minimizes the "tight squeeze" cases where the last part in a cluster has to drop into a tight space.*

- *Stuff only a few parts at a time (3-4 pieces). If*



you try to add too many parts at once between soldering operations, you may lose track and wind up with missing solder joints! Once you've stuffed the parts on the board, bend the protruding leads slightly outward to keep them in place while the board is inverted for soldering.

- Some of the disk and monolithic capacitors may be supplied with a lead spacing of 0.10" (2.5mm). The "ME30+" has generally been laid out for a 0.20" (5mm) capacitor spacing. The capacitor leads may be gently spread apart near the component bodies and then bent parallel to ease installation. Due to availability some radial capacitors may be axial (like resistors). Mount them just like resistors by bending one lead in a hairpin to mount vertically.

- If you decide to build the board into your own box and haven't ordered the enclosure kit you may want to solder wires directly to the circuit board and eliminate the headers. Header pins are supplied in the kit regardless and you can opt out in installing them.

- When installing most resistors and glass diodes, try not to hold part right against the board but allow a little space. This will prevent the lead from breaking off the body of device if they are accidentally bent over.

**Recommended Assembly sequence:**

There's nothing critical about the order in which the board is populated but some parts are best installed in a particular order, as noted within each group's instructions.

(The figures which follow are for reference only. See the pictorial drawing on Page 20 for component values and reference designations.)

**Caution: Again it must be repeated, extreme care should be taken with small capacitor lead spacing. Bend leads with needlenose for proper spacing. Do NOT pull leads through bottom of board with pliers otherwise you will break a lead off the capacitor.**

[ ] Install D13, U2, C102, and C113. If you have the companion enclosure kit, install connectors J4 (2-pin) and J2 (3-pin) as well. This step supplies DC power to the board and installs the 8 Volt regulator IC.

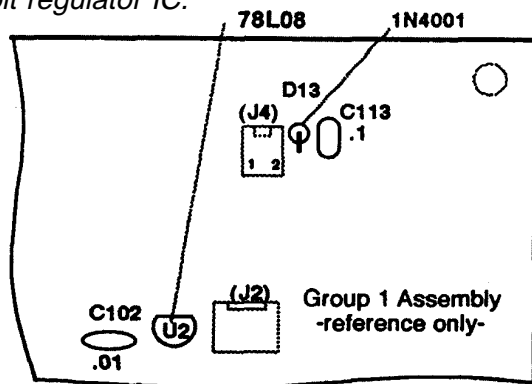

[ ] Install an 8-pin IC socket at U4.

[ ] Install the components shown below:

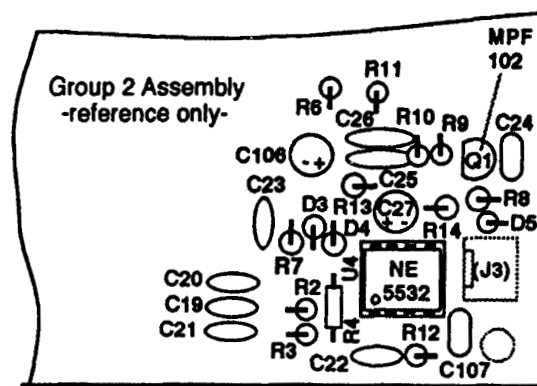

(When these components have been installed, the audio amplifier section of the transceiver is complete.)

[ ] Install an 8-pin IC socket at U3.

[ ] Install the components shown below:

*Note: Space the crystals slightly off the board. The bottom of crystals may short to the crystal pads.*

*Note: The 5 crystals supplied with this kit have been preselected as a group. They are interchangeable within this group. Do not, however, substitute replacement parts – contact Midway Electronics for assistance.*

[ ] Place jumper made from a component lead in the C16 location.

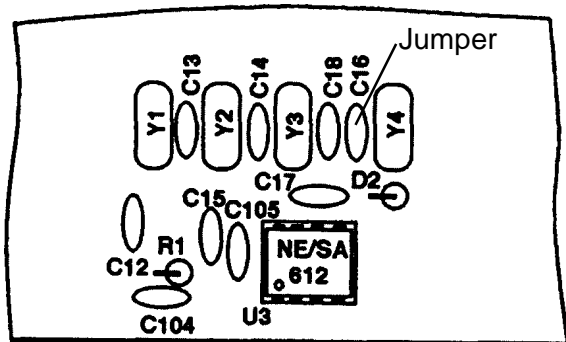

Group 3 Assembly  
-reference only-

(When these components have been installed, the product detector/BFO and crystal filter sections of the transceiver are complete.)

[ ] Install an 8-pin IC socket at U1.

Install the components shown below:

L1 (yellow core). C7 is not installed at this time; see "Alignment" for installation procedure.

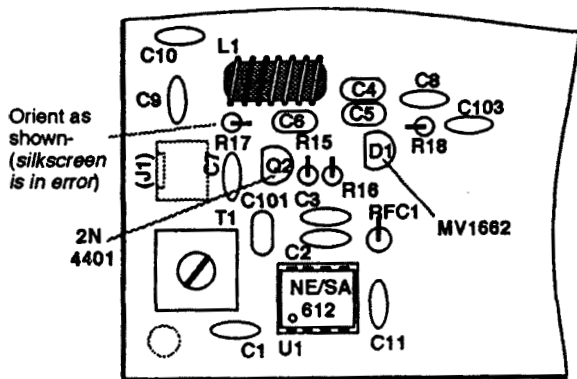

Group 4 assembly  
-reference only-

(When these components have been installed, the receiver portion of the transceiver is complete.)

[ ] Install an 8 pin IC socket at U5.

[ ] Install the components shown below.

The following components are polarity sensitive:

D11, C110, Q3, Q4, Q5

Spacing on C31 (between transformers T2 and T3) is quite tight. Install his capacitor prior to installing T2 and T3.

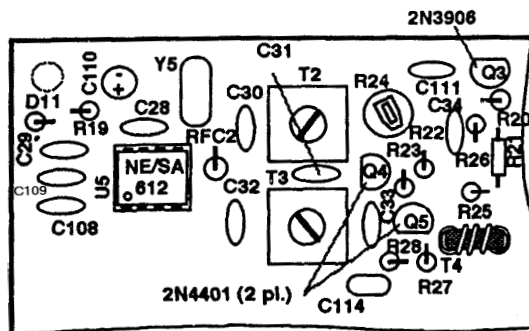

Group 5 assembly  
-reference only-

[ ] Install T4.

[ ] Add a secondary winding to T4 as follows:

1) Strip 1/8 inch of insulation from both ends of a 1-1/2" (4 cm) length of insulated wire. Twist the wires gently between your fingertips to ensure that all strands are bundled together. Tin both ends with solder.

2) Install one end in S2 and solder.

3) Take the free end of this wire in the direction of S1 and then double it back through the center of L4. Use tweezers or needle nose if necessary.

4) Draw the lead snug (not tight!) and proceed around the toroid material until you've formed one complete turn through the toroid as shown below:

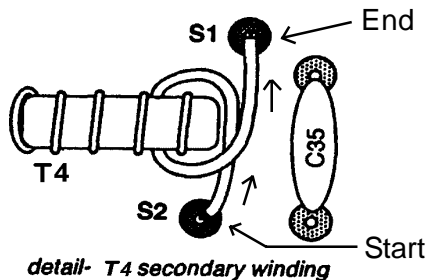

5) Install this lead-end in S1 and solder.

*(When these components have been installed, the transmitter mixer, bandpass filter, and driver sections of the transceiver are complete.)*

The following components are polarity-sensitive:

C112, D6-10, D12, Q6

[ ] Install the components shown below:

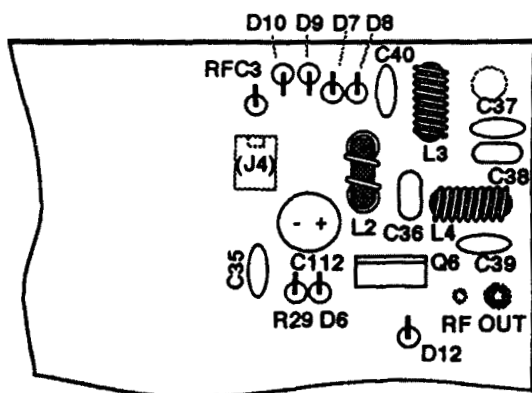

Group 6 assembly  
-reference only-

Q6 (2SC2078) is installed with the metal tab to the rear (or 'top' when viewed from directly overhead). When viewing the board from the front edge (U1, U3, and U4 nearest you), Q6's labeling must be viewable.

[ ] Install L2 and L3

*(When these components have been installed, the board assembly is complete.)*

If you have not already done so, install all integrated circuits on the board as indicated on page 15. Be sure that the ICs are oriented properly – the dot or notch is on the left side of the 8-pin DIP ICs as shown on the pictorial. Make sure you don't fold a pin under the IC.

**CLEAN UP YOUR ACT!** Before you install the finished PC board into an enclosure, grab some cotton balls and use acetone (nail polish remover), methylene chloride, or toluene to remove solder flux from the foil-side of the PC board. The result is a much cleaner appearance once you've completed this step.

## Wiring the ME30+

The picture on next page shows the schematic interconnect between the ME30+ board and the outside world (more on alignment later).

Short, direct leads between the ME30+ board and your connectors and controls are advisable. It is recommended you use a small length of RG-174 from the board to the antenna connector. The other interconnect wiring is less critical, but try to avoid routing the wiring over the audio (U4) filter section and RF output transistor if possible.

The optional enclosure kit includes .100" header housings, pots, jacks, wire, and pins. Install these if you have this kit.

If you have just the board kit, proceed to wire directly to J1, 2, 3, 4.

Wire the connectors and controls to the ME30+ as shown pictorially below. Note that the keying return line lacks its own distinct board ground. This return line is shared with the headphones' return.

## STOP!

Before you progress to the next phase of the project, this might be a good time to check out the ME30+. Add the various connectors and controls using temporary leads before you get the project buttoned up in a box. If you need to do any troubleshooting, you'll have saved the aggravation of having to undo all the wiring to get at the bottom side of the board!

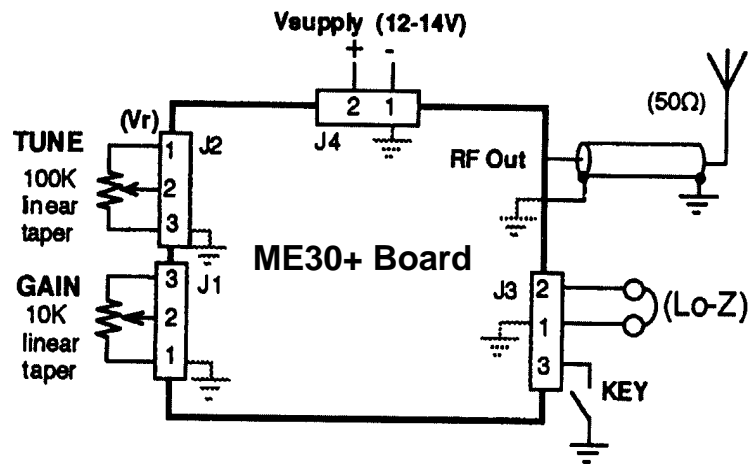

### ME30+ Mechanical Details

The pictorial figure below shows connectors and their accompanying mounting hole diameters. These are merely suggestions and are a matter of personal preference. The board itself is mounted in an enclosure at the board's four corners using standoffs.

Enclosures may be found in a variety of styles. Ebay has many of these up for auction. Search "aluminum project box".

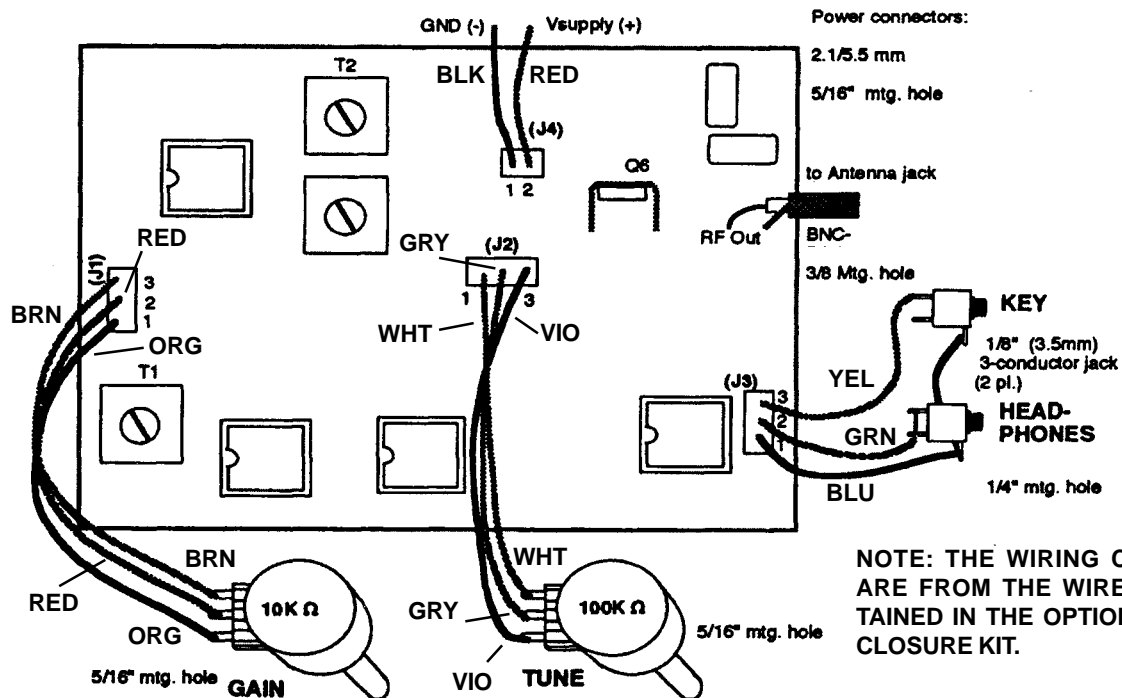

## Before the “Smoke Test”:

Inspect your work to ensure there are no solder bridges or unsoldered joints. Check to see that the ICs are mounted in their proper orientations.

### Alignment:

Alignment is easy with this little rig. For test equipment, you’ll need a main-station rig and multimeter or SWR bridge. Here’s how:

#### Transmitter alignment:

[ ] Connect a tuning pot to J2. (See page 12 for interconnect pictorial.) Set the tuning pot to full counterclockwise (0V on the pot’s center terminal).

[ ] Connect a 50 ohm dummy load to ‘RF Out’ and its adjoining ground return pad.

[ ] Set trimmer R24 to the half-scale (3 o’clock) position. Do not exceed the half-scale position until T2 and T3 have been peaked to maximum. Yes...you may have to ‘hunt’ for an output power indication!- those two adjustment peaks are fairly narrow.

[ ] Using a insulated tuning tool or small slot screwdriver, preset the tuning slugs in T2 and T3 to the middle of their rotation range. (*This is non-critical; there’s no need to count turns.*)

[ ] Add a clip lead to R29 (see figure below) to serve as a short whip antenna. Leave the other end of the clip lead unconnected, and ensure that this free end is well away from other circuitry.

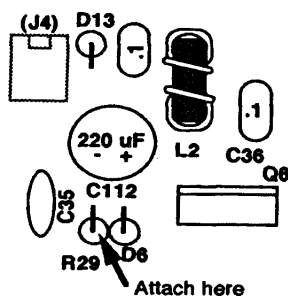

[ ] Apply DC power to (J4)

[ ] Ground the “Key” (J3-3) input.

[ ] Tune in your transmitted signal on your “big rig” receiver. This should be a strong carrier (S9+20 or better) around 10.10-10.30 with tune knob fully clockwise and no capacitor in C7 position. If not near this frequency, count number of turns on L1. It should be 28 turns.

*Be sure to hunt for the strongest signal over a range of 10.10 to 10.30 MHz to ensure that you find the primary signal instead of a receiver spurious response.*

### Operating frequency selection:

The CW portion of the 30 meter band doesn’t have designated QRP frequencies as of this printing.

The digital portion of the band is 10.13 to 10.15.

Decide what span of frequencies you desire.

[ ] Note the frequency from the step above. Remove power and install a value of C7 in accordance with the table below.

If the frequency is between	Install the following value for C7
10.10-10.13	120 pf
10.12-10.15	100 pf
10.14-10.17	82 pf
10.15-10.18	68 pf
10.17-10.20	47 pf
10.20-10.23	22 pf
10.22-10.26	* none

\* There should be a birdie on 10.240 MHz.

Make sure you stay at least 2 KHz inside the 30 meter band of 10.10 and 10.26 MHz.

[ ] Re tweak T2 and T3 once you are satisfied with the frequency span.

It's possible to adjust the operating frequency as much as 15-20KHz downward by squeezing L1's turns more closely together. If in doubt as to which of two values of C7 to use, install the smaller of the two and compress L1's turns as needed.

Note: The tuning pot adjusts the L.O. (local oscillator) or V.C.O. (voltage controlled oscillator). The higher the tuning voltage, the higher the frequency in the 20, 30 and 40 meter radios. In the 80 meter radio it is just the opposite.

## Checkout

Connect the RF output to a wattmeter (if you have one). You can also use your SWR meter with a dummy load connected and set in the "Forward" metering position.

If you don't have either of these pieces of equipment, you can 'haywire' the test circuit below on a scrap of copperclad board. This peak detector circuit furnishes a DC voltage to your multimeter.

Test Circuit schematic

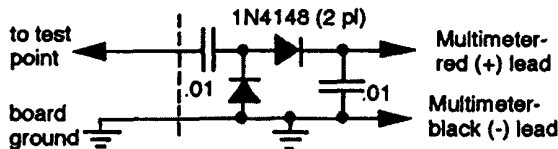

Adjust T2 and T3 for maximum indicated signal on your receiver's S-meter. The adjustment will be somewhat interactive, so alternate between the two for maximum "output".

[ ] Remove the clip lead. Adjust trimmer R24 as needed for 1.5 watts of key-down power into a dummy load or the test circuit shown on the previous page. (*For the test circuit above, this corresponds to a DVM measurement of 24V DC*). Increase drive (turn R24 clockwise) only as needed to get to this level.

## Receiver alignment:

[ ] Connect a matched antenna to "RF Out" and its ground return. Using a small slot screwdriver, peak T1 for maximum signal (or noise). Once this step is complete, background noise should be noticeably higher with an antenna connected than without.

"Can I set it for more output power?" Sure! The component values in the PA stage were designed for maximum efficiency at 1.5W out. The ME30+ will deliver considerably more, but please be aware of the following:

- The higher the output power, the more heat is being generated by the PA, and this translates into 'driftier' performance in the local oscillator.
- There's a possibility of instability in the driver (Q4/Q5) stage with R24 set to maximum. IF THE SIDETONE SOUNDS RASPY OR VANISHES ENTIRELY, reduce the R24 setting.

## Troubleshooting the ME30+

The "bugs" you're most likely to encounter often turn out to be caused by the simplest of problems. If your ME30+ doesn't play, the following general suggestions may be helpful:

*"It works better plugged in!"*

We've all heard that expression before, but unfortunately it's true. Ensure that DC power is getting to the ME30+. A board with no voltage anywhere probably isn't getting "power".

*“The headphones are silent!”*

It’s probably the same as above – an interconnect problem. The 1/8” (3.5mm) jacks in particular are trouble-prone.

Check once more for solder bridges and missing solder joints. Probing a suspect section of the circuitry with a fingertip or insulated tool will sometimes bring a stubborn circuit to life – if so, check again for a bad connection!

*Of the returns I see, about 85% of problems are caused by cold solder joints, 5% by solder bridges, and 5% due to incorrect resistor or diode installation. That leaves only 5% for all the other problems put together!*

Ensure that ICs are installed in the correct location and with the right orientation. Likewise, ensure that the transistors and all diodes are installed with the correct orientation.

If you don’t turn up anything with the above steps, see the troubleshooting schematic page 17.

Using a DVM, check the circuit points noted on the drawing against your ME30+ to confirm that the DC voltage readings are all in order.

*Here’s a rule of thumb for the troubleshooting voltages: I’ve supplied the nominal voltage readings, but there’s some unit-to-unit variation. As an overall guideline, a 20% variation is an acceptable tolerance. If you’re making use of this schematic, “something’s broke”, and things don’t generally break just a little; you’re looking for the obvious departures from the published values.*

The troubleshooting schematic also lists AC voltage readings in case you have access to an oscilloscope or have a high-impedance input RF probe. Readings are given in Volts p-p.

The figure below illustrates IC pinout. The “pin”1 at lower left convention applies to all Dual In-line-Package (DIP) ICs.

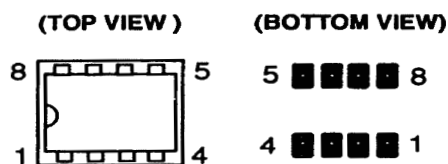

“Strange but True” – In general, the ICs themselves shouldn’t be prime suspects during the troubleshooting process. Despite their complexity, they’re very reliable, and I’ve had to replace these parts at the rate of only 1 for every thousand or so shipped! If those steps don’t turn up anything, here are some additional steps to try:

Once you are satisfied that the transceiver is tuned and ready to mount, it is advisable to put a few drops of hot melt glue or beeswax around L1, L2, L3, L4, and T4 to keep them from jarring loose if transceiver dropped.

## Receiver

Touching either of the 10K resistor leads to the left of the AF Amp IC (U4) should cause an easily-audible hum or buzz in the headphones. If not, and Vr (the 8V supply) is OK, the NE5532 op amp (U4) is suspect.

Touching an antenna wire to the 470 ohm resistor to the left of U3 (product detector) should cause shortwave “crud” to be audible in the headphones. Also, a signal source such as your main transmitter (on minimum power, please!) should provide a plainly audible signal when you transmit a string of CW characters just above or below the 7.680MHz IF frequency. Do not connect the main station transmitter to the ME30+! Stray leakage is sufficient. Similarly, you should be able to hear the BFO at about 7.68 MHz on your main station receiver. If not, these steps point to a problem with U3 or its associated BFO components (Y4 and C17-18).

## Transmitter

*Be sure a load is connected anytime you're troubleshooting the transmitter.*

Verify that the keying switch Q3 supplies 12V DC to the transmit mixer (U5) and buffer/driver (Q4-5) stages when the "Key" input is grounded. Note that the voltage reading at pin 8 of U5 should be 7.1 to 7.9 volts. No voltage during key-down suggests that Q3 is bad or that D11 is installed backward.

Touching a screwdriver to Q6's case (collector) should yield a distinct (key-down) increase in signal received on your 'big rig' receiver. If not, suspect Q6.

If you want to change the sidetone pitch, increasing the value of C29 raises the sidetone pitch (and Tx offset), and decreasing that cap lowers it.

If you are unable to get your ME30+ working, contact Midway Electronics for further technical support or view FAQ page at: <http://www.midwayelectronics.us/qrp/faq.htm>

Troubleshooting/alignment is available for a \$35 fee inside the US. The unit will be returned to you in working condition and will include a troubleshooting report. The price includes return shipping. Please do not send the unit without contacting Midway first. Please do not call Midway. Email tech support only. [midway7726@gmail.com](mailto:midway7726@gmail.com)

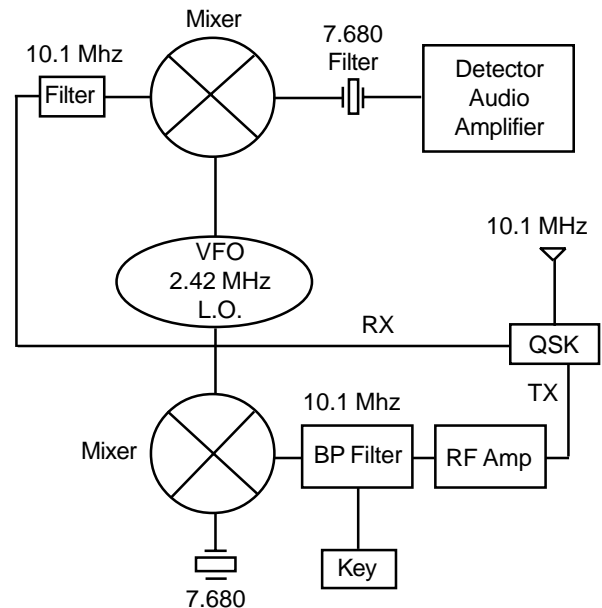

L.O. = CF - IF  
L.O. = 10.1 - 7.680  
L.O. = 2.42 MHz



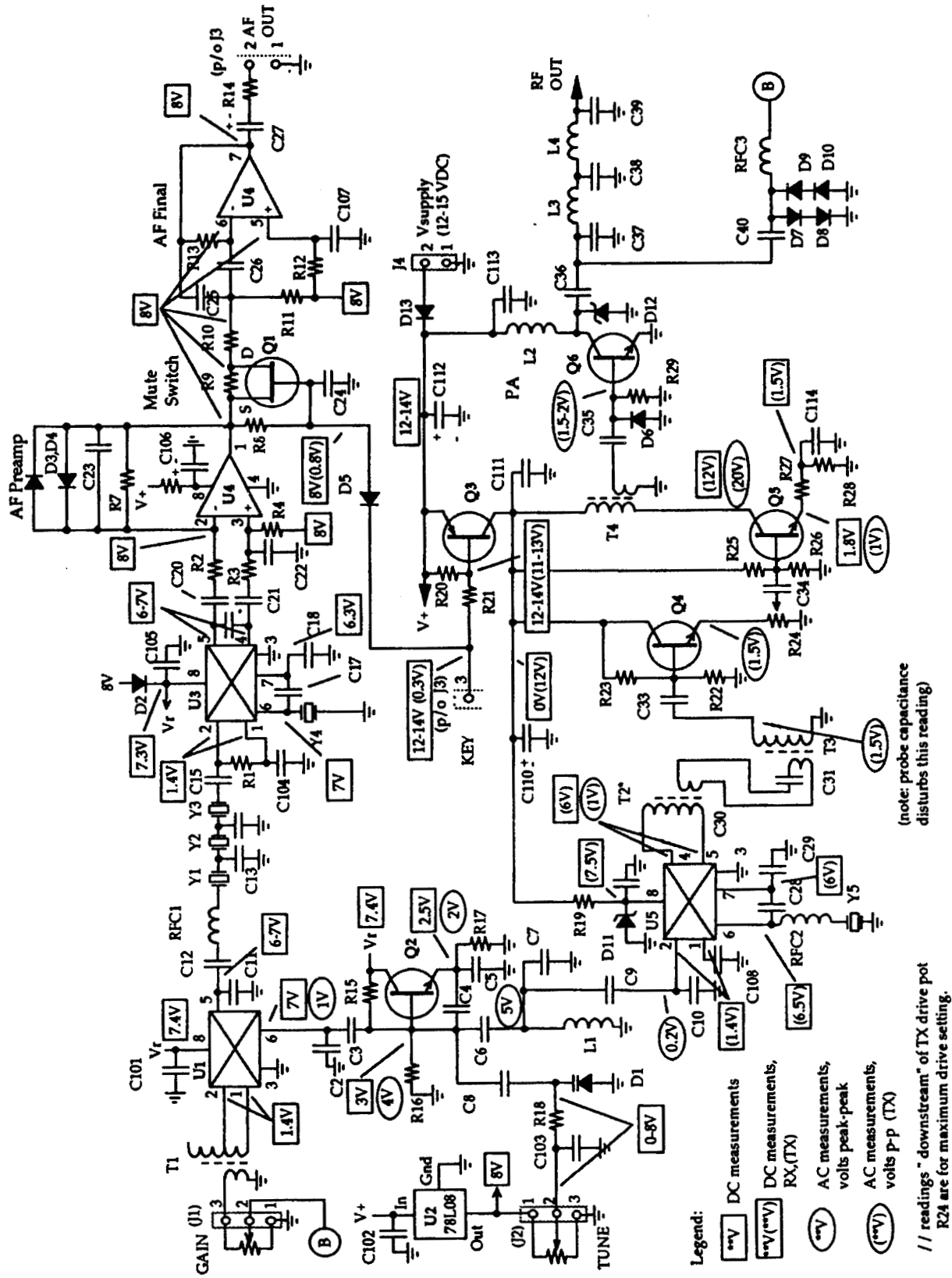

(note: probe capacitance disturbs this reading)

// readings "downstream" of TX drive pot R24 are for maximum drive setting.

- Legend:
- [\*\*V] DC measurements
- [\*\*V(\*\*V)] DC measurements, RX,(TX)
- (\*\*V) AC measurements, volts peak-peak
- (\*\*V) AC measurements, volts p-p (TX)

# Troubleshooting Voltages for the ME30+ Transceiver

# Parts List ME30+ Transceiver

Qty	Ref. Designation	Description	Identification
2	C3,C9	10 pF ceramic disk	'10' or 10P or 100
3	C7A,C11,C40	22 pF NPO cer. Disk	'22' or 22P or 220
3	C2,C7B,C28	47 pF NPO cer. Disk	'47' or 47P or 470
2	C7C,C17	68 pF NPO cer. Disk	'68' or 68P or 680
1	C7D,	82 pF NPO cer. Disk	'82' or 82P or 820
1	C7E	100 pF NPO monolithic cap	epoxy, '101J' or N10
2	C7F,C8	120 pF NPO monolithic cap	epoxy, '121J' or N12
4	C18,C22,C23,C31	150 pF ceramic disk	'151' or N15
1	C29	220 pF ceramic disk	'221' or N22
5	C10,C12-C15	270 pF ceramic disk	'271J' or N27
2	C37,C39	330 pf ceramic disk	'331J' or N33
1	C38	680 pf ceramic disk	'681J' or N68
1	C25	820 pF mylar cap	'821J' or N82
3	C4,C5,C6	3300 pF NPO mono. cap	epoxy, '332J' or 3N3
1	C26	.0022 uF mylar cap	'222J' or 2N2
11	C21,33-35,102-105,108,109,111	.01 uF ceramic disk	'103M' or U01
1	C19	.033 uF disk or mono. cap	'333J' or 33N
7	C20,24,36,101,107,113,114	0.1 uF mono. cap	epoxy, '104' or U10
1	C110	3.3 uF 50V radial elec. cap	banded end is neg. or 3U3
2	C27,C106	47 uF 16V radial elec. cap	banded end is neg. or 47U
1	C112	220 uF 16V radial elec. cap	banded end is neg.
1	D1	1SV149 Varicap diode	
9	D2-10	1N4148A diode	glass body
1	D11	7.5V 0.5W 5% Zener diode	1N5236B
1	D12	33V 0.5W 5% Zener diode	1N5257B
1	D13	1N4001 diode	black case
1	L1	T-50-6	0.50" dia., yellow
1	L2,T4	FT37-43	0.37" dia., dark grey
2	L3,4	T-37-6	0.37" dia., small yellow
1	Q1	MPF102 or 2N5486 JFET	plastic case (TO-92)
1	Q3	2N3906 PNP	plastic case (TO-92)
3	Q2,4,5	2N4401 NPN	plastic case (TO-92)
1	Q6	2SC2166	TO-220 NPN Pwr transistor
2	RFC1,3	10uH RF choke	Brn-Blk-Blk-Silver
1	RFC2	6.8uH RF choke	Blu-Gra-Gold-Silver
1	R24	500 ohm trim pot	3 leads
3	R6,14,27	10 ohm ¼W 5% resistor	Brn-Blk-Blk-Gold or 10R
2	R28,29	51 ohm ¼W 5% resistor	Grn-Brn-Blk-Gold or 51R

2	R1,26	470 ohm ¼W 5% resistor	Yel-Viol-Brn-Gold or K47
1	R19	1K ohm ¼W 5% resistor	Brn-Blk-Red-Gold or 1K0
2	R17,25	2.2K ohm ¼W 5% resistor	Red-Red-Red-Gold or 2K2
4	R2,3,21,22	10K ohm ¼W 5% resistor	Brn-Blk-Orange-Gold or 10K
4	R10,16,20,23	22K ohm ¼W 5% resistor	Red-Red-Orange-Gold or 22K
1	R15	47K ohm ¼W 5% resistor	Yel-Viol-Orange-Gold or 47K
3	R4,7,11	510K ohm ¼W 5% resistor	Grn-Brn-Yel-Gold or M51
4	R8,12,13,18	1M ohm ¼W 5% resistor	Brn-Blk-Grn-Gold or 1M0
1	R9	4.7M ohm ¼W 5% resistor	Yel-Viol-Grn-Gold or 4M7
4	S1-S4	8-pin low-profile IC socket	
3	T1-3	10.7MHz IF transformer	42IF123
1	U2	78L08 voltage regulator	plastic case (TO-92)
3	U1,3,5	SA602AN, or SA612AN	8-pin IC
1	U4	NE5532	8-pin IC
5	Y1-5	7.68MHz crystal	HC-49/U holder, 20pF
12		header pins (1 extra)	
1		2 pin header housing	
1		2 pin male header	
3		3 pin header housing	
3		3 pin male header	
1		1 pin male header	

## Optional Enclosure Kit (Bag 5+6)

1	Custom case
4	Rubber feet
4	Nylon standoffs
1	10K linear taper pot
1	M10 linear taper pot
1	Large knob
1	Small knob
2	3.5 mm stereo jack
1	2.1x5.5 mm power jack
1	BNC bulkhead connector, round
2	#4-40 X 1/4 stainless pan head screw

Crystal code \_\_\_\_\_

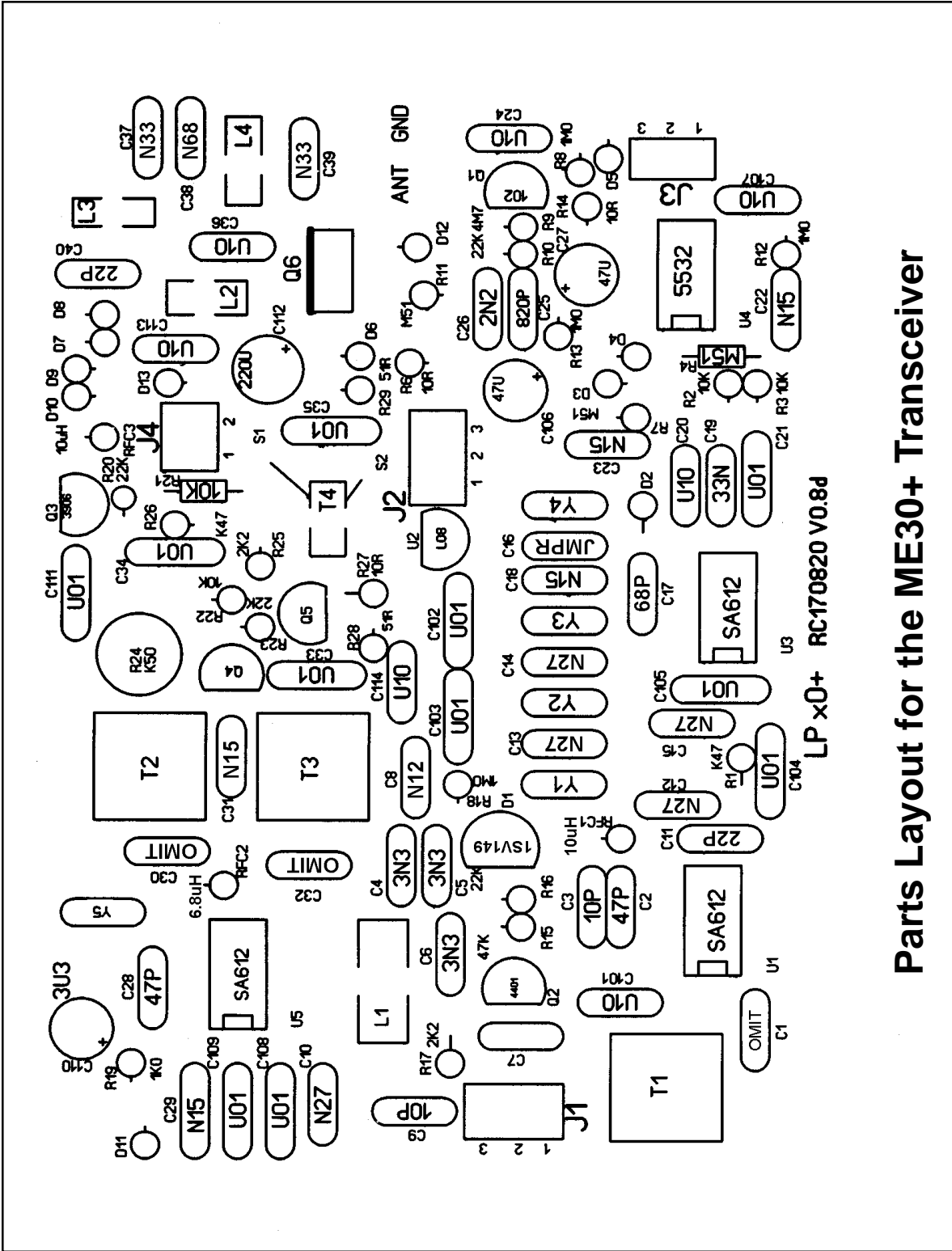

LP x0+ RC170820 V0.8p

**Parts Layout for the ME30+ Transceiver**

## Appendix

### Ribbon cutting:

Strip away black wire from ribbon cable. Cut 3" (8 cm) off and save.  
 Discard remaining.  
 Strip away white/gray/violet from cable. Cut 4" (10 cm) off and save.  
 Discard remaining.  
 Strip away blue/green/yellow from cable and save.  
 Cut 3" (7.5 cm) off of remaining brown/red/orange cable and save.  
 Strip orange and brown away. Cut 3" (8 cm) of red and save.  
 Cut 2 inches of orange wire for the secondary of T1  
 as used on the bottom of Page 10. Discard remaining.

You should have the following wires to complete assembly:

- 6" (15 cm) blue/green/yellow
  - 3" (8 cm) brown/red/orange
  - 4" (10 cm) white/gray/violet
  - 3" (8 cm) black
  - 3" (8 cm) red
- Solder or professionally crimp header pins on one end of each wire. (11 places.)

### Bag 4

- 5 toroids
- 3-3 pin header pins
- 1-2 pin header pins
- 61" (155 cm) #24 ga. magnet wire
- 6" (13 cm) ribbon hookup wire
- 4" (11 cm) RG174
- 3-42IF123-RC
- 4-IC sockets
- 2-10uh RFC
- 1-6.8uh RFC
- 2- Zener diodes
- 12-female header pins

### Bag 3

- 1-1N4001
- 9-1N4148
- 1-78L08
- 1-2N3906
- 3-2N4401
- 1-MPF102
- 1-1SV149
- 3-SA612
- 1-NE5532
- 5-7.680mhz xtal
- 1-2SC2166

### Bag 1

All capacitors

### Bag 2

All resistors

Keep the RF chokes in this bag until you're ready to install. This way they're less likely to be confused with the resistors.  
 Keep Zener diodes in this bag too so you won't mix them up with the other diodes.

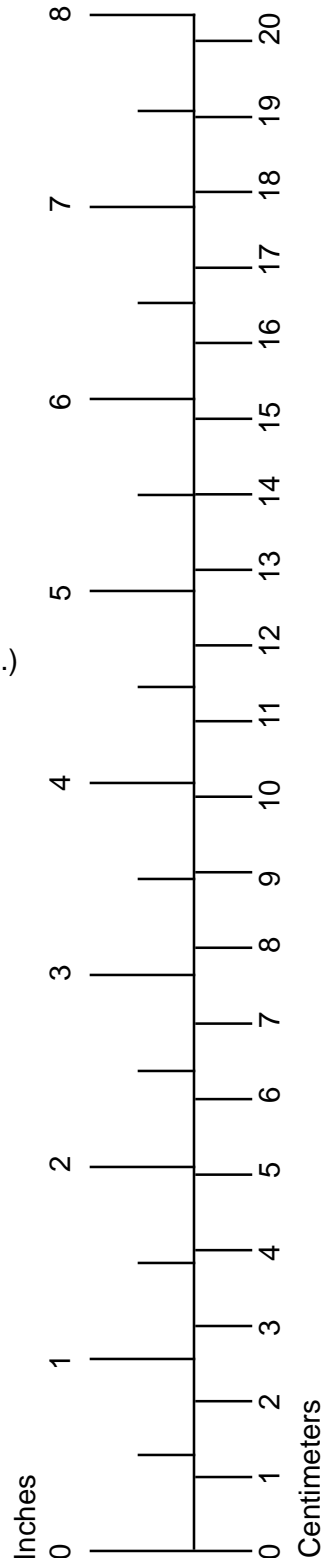

# Addendum

Use only enough solder to make good clean connection. If your connection has a large round bead, you have used too much solder and could create a bridge between two pads. Try and hold board upright and apply soldering iron tip to pad from below to draw excess off via gravity. Be careful not to use too much heat. Clip excess lead close to solder joint.

D1 1SV149 looks like a standard TO92 with two pins. The curved back of the 1SV149 should follow the same curve as the white silk screen pattern on circuit board.

Care must be taken when inserting IC's so you don't fold a pin under the device.

Before you begin you must decide if you are going to solder all wires directly to the board or use headers and pins. For easily removing board for testing or troubleshooting we recommend you use the headers.

When stripping enameled wire off toroid for soldering, use utility (Xacto) knife blade and carefully scrape off enamel down to copper. Be careful not to nick the wire or weaken it by scraping too much copper off.

Place a drop of hot melt glue, beeswax, or silicone RTV under each toroid to keep it from moving around and breaking a lead off if the ME40+ is accidentally dropped.

Keep resistors, diodes and crystals slightly off the circuit board when soldering. Electrolytic capacitors, transformers, header pins, and IC sockets should be held tight against board when soldering.

For latest information including latest release of this manual can be found on the Midway website:  
<http://www.midwayelectronics.us/qrp>

Don't mix up the temperature stable NPO capacitors with regular ceramic ones. Keep NPO channeling caps in the small bag until ready to use. Tape unused caps to manual for future modifications.

Some capacitors are cut from a reel of tape. Rather than pulling capacitor off tape and leaving some adhesive on leads, you should be able to cut the capacitors off the tape with scissors or diagonal cutters. If you cut near the tape, the leads will still be long enough to insert in the board and bend leads over.

Use good 0.31 or smaller solder and a 63/37 or 60/40 rosin mix. This leaves a good clean connection on the pads.

The NPN transistors can be 2N4401, 2N2222, PN2222, or 2N3904 but the 2N4401 seems to yield the highest power out.

The crystals have been matched. If you have a defective one, a correct replacement can be sent. Please take note of the reference number in the crystal bag and mark it down on page 19.

Refer to the website for many other hints and suggestions in the assembly and testing of this kit.