

Radioddity GD-168

Digital DMR and Analog
UHF/VHF Amateur Radio Transceiver

Operating Manual

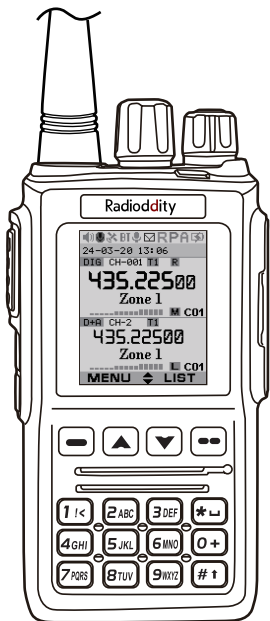

DMR
DIGITAL MOBILE RADIO ASSOCIATION



NOTE

- » **When you use CPS (computer program software) to program the radio, start by reading the factory software data, and then rewrite this data with your frequency etc., to a new saved code plug, otherwise errors may occur.**
- » **The CPS allows you to program the frequency, channel type, power etc. your programming must comply with your FCC (or other country) license certification.**

CONTENTS

1.UNPACKING AND CHECKING THE EQUIPMENT	1
1.1 Supplied Accessories.....	1
1.2 Standard Accessories	2
2.BATTERY INFORMATION	3
2.1 Charging the Battery Pack	3
2.2 Charger Supplied.....	3
2.3 Use Caution with the Li-ion Battery.....	3
2.4 How to Charge.....	4
2.5 How to Store the Battery.....	5
3. PREPARATION	6
3.1 Installing / Removing the Battery	6
3.2 Installing / Removing the Antenna	6
3.3 Installing / Removing the Belt Clip	7
3.4 Installing the Additional Speaker/Microphone (Optional).....	7
4. Radio Overview	8
4.1 LCD.....	9
4.2 Status Indications.....	9
4.3 Programmed Key	10
4.4 Hot Key Setting for PF1, PF2.....	12
4.5 Combination Key Function.....	12
5.BASIC OPERATIONS	13
5.1 Power on the Radio	13
5.2 Adjust Volume	13
5.3 Main band/Sub band switch.....	13
5.4 VFO/Channel switch	13
5.5 Set up VFO frequency	13
5.6 Select a Channel.....	13
5.7 New channel	14
5.8 Delete Channel	14
5.9 Receiving and Responding to a Radio Call	14

5.10 Making a Call	15
5.11 Monitor	15
5.12 Emergency Alarm.....	15
5.13 Battery Voltage Test.....	15
6. ADVANCED FEATURES	16
6.1 Access Advanced Features for Private Call	16
6.2 Set up Advanced Features for Private Call	16
7.MAIN MENU FUNCTIONS.....	18
7.1 Talk Group.....	18
7.2 SMS	18
7.3 Call Log.....	18
7.4 Zone.....	18
7.5 Scan.....	19
7.6 Roaming.....	20
7.7 Settings	21
7.7.1 Radio Set.....	21
7.7.2 Chan Set.....	27
7.7.3 Device Info.....	33
7.8 Record	33
7.9 GPS Positioning Function(optional with installed GPS).....	34
7.10 Satellite	35
7.11 APRS Location Reporting(optional, supported by GPS).....	35
7.12 Digital Monitor	37
8.RESET.....	38
9.TROUBLE SHOOTING GUIDE.....	39
10.PROGRAMMING GUIDE	40
11.ON-LINE SERVICE AND SUPPORT	42
SAFETY	43
12.TECHNICAL SPECIFICATIONS	45

1. UNPACKING AND CHECKING THE EQUIPMENT

Unpack the radio carefully. We recommend that you identify the items listed in the following table before discarding the packing materials. If any items are missing or have been damaged during shipment, please contact the carrier or the dealers immediately.

1.1 Supplied Accessories

Item	Quantity
Antenna	2
Li-ion Battery Pack	2
Battery Charger	1
AC Adaptor	1
TYPE C Cable	1
Belt Clip	1
Instruction Manual	1

1. UNPACKING AND CHECKING THE EQUIPMENT

1.2 Standard Accessories



12cm Antenna
TX-0311

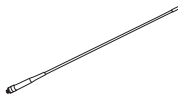

38cm Antenna
TX-0313



Li-ion Battery Pack
QB-56L(1800mAh)



Li-ion Battery Pack
QB-56HL(2500mAh)



Charger
QBC-56L



AC Adaptor
NA01(5V/2A)

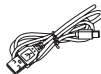

TYPE C Cable
QT-0046
(Program and Charge)



Belt Clip
WWZZ-0029



Instruction Manual

*** Note:** For frequency band of antenna, please refer to label indicated in the bottom of the antenna.

2. BATTERY INFORMATION

2.1 Charging the Battery Pack

The Li-ion battery pack is not charged at the factory; please charge it before use. Charging the battery pack for the first time after purchase or extended storage (more than 2 months) may not bring the battery pack to its normal maximum operating capacity. Best operation will require fully charging/discharging the battery two or three times before the operating capacity will reach its best performance. The battery pack life may be depleted when its operating time decreases even though it has been fully and correctly charged. If this is the case, replace the battery pack.

2.2 Charger Supplied

Please use the specified charger provided by Radioddity. Other models may cause explosion and personal injury. After installing the battery pack, and if the radio displays low battery with a red flashing lamp or voice prompt, please charge the battery.

2.3 Use Caution with the Li-ion Battery

- a. Do not short the battery terminals or throw the battery into a fire. Never attempt to remove the casing from the battery pack, as Radioddity cannot be held responsible for any accident caused by modifying the battery.
- b. The ambient temperature should be between 5°C -40°C (40°F - 105°F) while battery. charging the battery. Charging outside this range may not fully charge the battery.
- c. Please turn off the radio before inserting it into the charger. It may otherwise interfere with correct charging.
- d. To avoid interfering with the charging cycle, please do not cut off the power or remove the battery during charging until the green light is on.
- e. Do not recharge the battery pack if it is fully charged. This may shorten the life of the battery pack or damage the battery pack.
- f. Do not charge the battery or the radio if it is damp. Dry it before charging to avoid damage.

WARNING:

» When keys, ornamental chain or other electric metals contact the battery terminal, the battery may become damage or injure a human. If the battery terminals are short circuited it will generate a lot of heat. Take care when carrying and using the battery. Remember to put the battery or radio into an insulated container. Do not put it into a metal container.

2. BATTERY INFORMATION

2.4 How to Charge

The radio uses a USB-C cable for charging, the USB-C cable can be inserted into the USB-C port on radio for directly charging to the battery.

The USB-C cable can also be inserted into the USB-C port on desktop charger. The standard 5V/2A USB-C adapter is used, it is common adapter on the market.

- a.** Plug the AC adaptor into the AC outlet, and then plug the cable into the USB-C port located on the back of the charger. The indicator lights green and is then ready to charge a battery.
- b.** Plug the battery or the radio into the charger. Make sure the battery terminals are good in contact with charging terminals. The indicator light turns to red--- charging begins.
- c.** It takes approximately 2.5 hours for QB-56L thin battery to be fully charged, and 3.5hours for QB-56HL thick battery to be fully charged. When the lamp lights green, the charging is completed. Remove the battery or the radio unit with its battery from socket

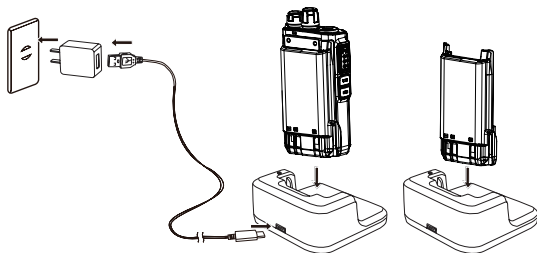

NOTE

» when charging a radio (with battery) the indicating lamp will not turn into green to show the fully charged status if the radio is powered on. Only when the radio is switched off will the lamp indicate normal operation. The radio consumes energy when it is power-on, and the charger cannot detect the correct battery voltage when the battery has been fully charged. So the charger will charge the battery in constant voltage mode and fail to indicate correctly when the battery has been fully charged.

2. BATTERY INFORMATION

d. LED Indicator:

STATUS	LED
Waiting(No Battery)	None
Precharge	Green Light
Charging	Red Light
Fully Charged	Green Light

 » **Trouble means battery too warm, battery short-circuited or charger short-circuited.**
NOTE

2.5 How to Store the Battery

- a. If the battery needs to be stored, keep it in status of 80% discharged.
- b. It should be kept in low temperature and dry environment.
- c. Keep it away from hot places and direct sunlight.

 » **Do not short circuit the battery terminals.**
NOTE » **Never attempt to remove the casing from the battery pack.**
» **Never store the battery in unsafe surroundings, as a short may cause an explosion.**
» **Do not put the battery in a hot environment or throw it into a fire, as it may cause an explosion.**

3. PREPARATION

3.1 Installing / Removing the Battery

- a. Match the two top grooves of the battery pack with the corresponding guides on the back of the radio and then push it.
- b. To remove the battery pack, slide the release latch at the bottom away from the battery and remove the pack from the transceiver.

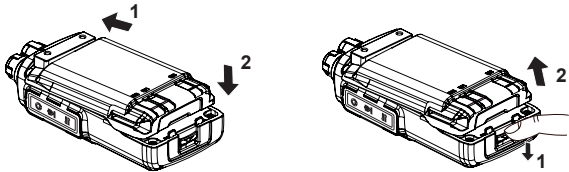

3.2 Installing / Removing the Antenna

- a. Installing the Antenna: Screw the antenna into the connector on the top of the transceiver by holding the antenna at its base and turning it clockwise until secure.
- b. Removing the Antenna: Turn the antenna counter-clockwise to remove it.

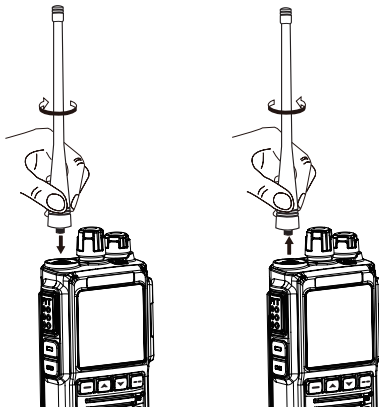

3. PREPARATION

3.3 Installing / Removing the Belt Clip

- a. Installing the Belt Clip: Place the belt clip above the corresponding holes on the back of the radio, and screw it into place clockwise with the two supplied screws.
- b. Removing the Belt Clip: Unscrew counter-clockwise to remove the belt clip.

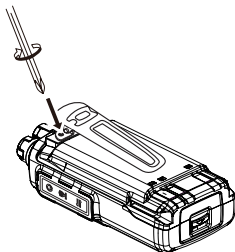

3.4 Installing the Additional Speaker/Microphone (Optional)

Pry open the rubber MIC-Headset jack cover and then insert the Speaker / Microphone plug into the double jack.

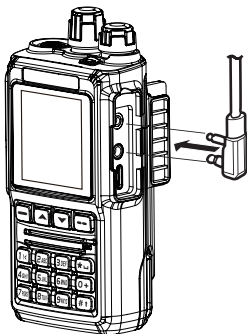

4. RADIO OVERVIEW

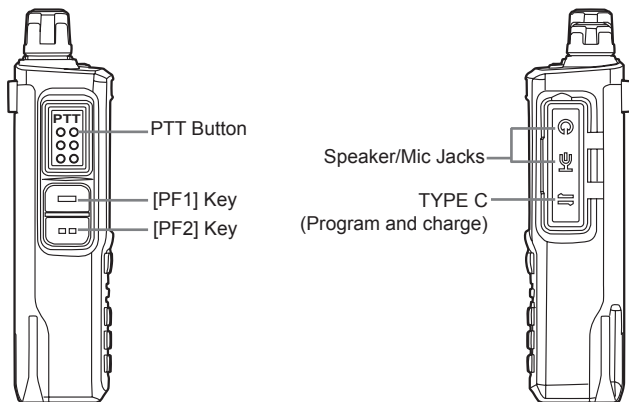
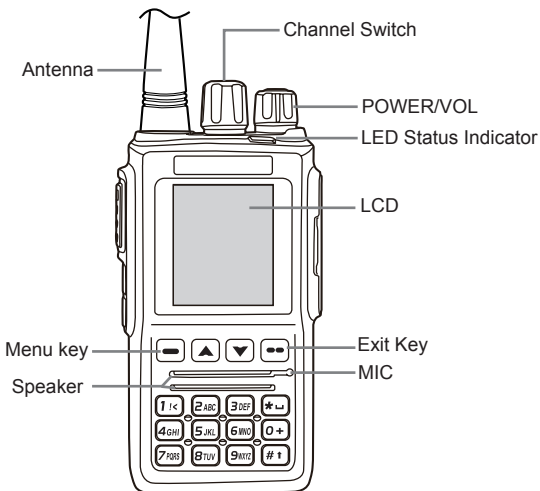

4. RADIO OVERVIEW

4.1 LCD

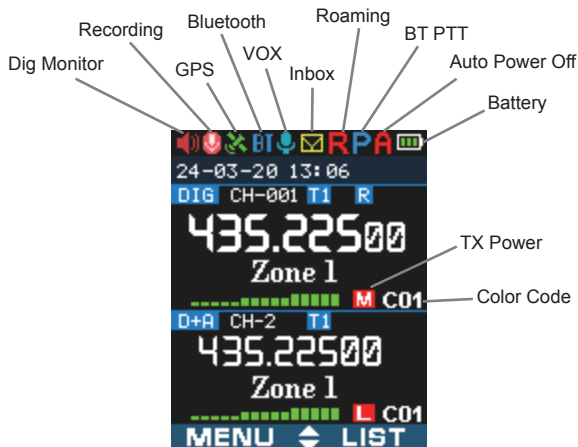

4.2 Status Indications

The top LED will help you to identify the current radio status.

LED Indication	Status
Flashes Red	Low battery voltage
Constant Red	Transmitting
Constant Green	Analog Receiving
Constant Cyan	Digital Receiving
Flashes Green	Scan

4. RADIO OVERVIEW

4.3 Programmed Key

It is possible to set different functions for [PF1], [PF2] keys.

Method 1: In radio Menu → Settings → Radio Set → Key → PF1, PF2.

Method 2: In PC software → Public → Optional Setting → Key function.

OFF	No Function
Volt	Check the current battery capacity voltage
Tx Power	Switch the power between super high, high, middle and low power.
TalkAround	Switch between Talk Around and Repeater mode
Reverse	Turn on/off the frequency reverse function.
Encryption	Choose the digital encryption group for digital channel
Call	In Analog mode, send the DTMF/5TONE/2TONE encode. This function is only valid for analog channel.
VOX	Set up the VOX level
VFO / MR	Switch between VFO mode and memory channel mode.
Sub PTT	Sub channel PTT, press to start the call on sub channel (NOTE: On PF1 - PF2 Keys Only)
Scan	Press the key to start or stop scanning the channels in scan list.
FM Radio	FM radio on/off
Alarm	Long press the key to start alarm, short press again to exit the alarm.
Record Switch	Enable/disable the recording function
Record	Start/stop recording. When stop recording, the radio will remind repeat or send the record.
SMS	In digital mode, press to enter into SMS messages
Dial	Start the manually dial
GPS Info (optional)	Check the GPS position information
Monitor	Monitor the weak signal or the signal with unmatched ID.
Main CH Switch	Choose channel A or channel B as the main channel
Hot Key 1~6	Selects Hot Keys 1-6 Note: Hot key setup details on next page
Work Alone	Turn on/off the work alone function.
Nuisance Delete	During scanning, press the key to skip the unwanted channel
Digi Monitor	In DMR mode, press the key to turn on/off digital monitor
Sub CH Hide	Turn on/ off the sub channel
Prior Zone	Switch to Priority Zone
VFO Scan	Press the key to start or stop the VFO scan. The VFO scan start and end frequency should be set in CPS -Optional Setting - VFO Scan.
MIC Sound	In digital channel, switch the microphone tone to normal or enhanced mode.

4. RADIO OVERVIEW

LastCall Reply	In digital channel, press the key to access the last call and press PTT to call back.
Switch ChType	Switch the channel type(Analog, Digital, Ana+Dgi, Dgi+Ana)
Ranging	When the radio receives a call and the suspension time is on, press the key programmed as" Ranging" to obtain the caller's position and distance. (Both party need GPS positioned, or will receive only GPS information)
Roaming	In standby, press the key programmed as "Roaming" to search and lock on the repeater with strongest signal. (Note: After lock on a repeater, the radio will return to last frequency only after channel or frequency is changed. The repeater frequency list must pre-programmed in CPS.)
Channel Ranging	In standby, if the call contact type for a channel is "Private call" , press the key programmed as " Channel Ranging" to turn on this function. The radio will automatically start ranging function when turn to this channel.
Max VOL Set	In standby, press the key programmed as "Max Volume", will enable users to set the maximum RX volume.
Slot Set	Choose Slot for current channel, this function is only valid in repeater mode.
Aprs Type	Choose Aprs Type for current channel.
Zone Select	In standby, press the programmed "Zone Select" key, it will allow you input the zone number and then press confirm key will switch to the zone.
Roaming Set	Sets Roaming Function
APRS Set (optional)	Sets APRS Function
Mute Timing	Press the key to mute the radio in set time. The mute timing should be set in CPS -Optional Setting - Other -Mute Timing.
CTC/DCS Set	Set the CTCSS/DCS for analog channel
TBST Send	Send the TBST Tone
BT On/Off (optional)	Enable / disable the bluetooth function
GPS On/Off (optional)	Enable / disable the GPS function
Ch. Name	Switch between channel name display and frequency display for the current channel
CDT Scan	Enable / disable the CTCSS/DCS scanning for the analog channel. When the radio finds matched CTCSS/DCS for current channel, it will open the speaker and start receiving. Only the analog channels with CTCSS/DCS signalling is able to start the CDT scanning.
ARPS Send (optional)	Manually transmit the APRS at the current channel.
DIM Shut	Light up or turn off the display/indicator.

4. RADIO OVERVIEW

GPS Roam (optional)	Enable / disable the GPS roaming function.
WX Alarm	Enable / disable the weather alarm function.
SQ Level	Set the squelch level.

4.4 Hot Key Setting for PF1, PF2

Enter radio Menu-Settings-Radio Set-PF1, PF2, sub menu. Users can choose settings for Hot Keys 1-6.

Hot Key function details must be setup in PC software ➔ Public ➔ Hot key.

Call	Analog	Should edit the analog quick call first, then choose analog in the hot key set. Press the key to transmit 2Tone/5Tone/DTMF to start the analog quick call.
	Digital	It allows to select a contact from the digital contact list, press the key to switch the channel to the contact temporary. It will switch back to the original contact after the group/personal call hold time.
Menu	SMS	Quick access to Messages in the Menu
	New Msg	Quick access to New Msg in the Menu - Messages
	Hot Text	Quick access to Quick Text in the Menu - Messages
	Received SMS	Quick access to Inbox in the Menu - Messages
	Send SMS	Quick access to Out box in the Menu - Messages
	Contact list	Quick access to Contact list in the Menu - Contacts
	Manual dial	Quick access to Manual Dial in the Menu - Contacts
	Call Log	Quick access to Call Log in the Menu
	Dialed Calls	Quick access to Dialed Calls in the Menu - Call Log
	Received Calls	Quick access to Answered Calls in the Menu - Call Log
	Missed Calls	Quick access to Missed Calls in the Menu - Call Log
	Zone	Quick access to Zone in the Menu
Radio set	Quick access to Radio Set in the Menu - Settings	

4.5 Combination Key Function

 + number key operation:

Press  key and hold until the LCD display "Next Please Press Dial Key", then press the number key, it will perform the programmed function.

Combination key function shall be setup in PC software-Public-Hot key.

5. BASIC OPERATIONS

5.1 Power on the Radio

Turn on the radio by turning the [Power/Volume] switch clockwise till a click is heard, and the LCD displays will show a start-up message, and you will hear a beep after 7 seconds.

5.2 Adjust Volume

Rotate the [Power/Volume] knob to adjust the volume. Turn clockwise to increase the volume and counterclockwise to decrease the volume. The LCD display will show the volume status during an adjustment.

5.3 Main Band/Sub Band Switch

Press the key programmed as Main CH Switch to switch the main channel to the other channel if there are 2 channels shown on the display. The channel with bold characters is the main channel.

5.4 VFO/Channel Switch

Press the key programmed as VFO/MR to switch between VFO and channel display.

5.5 Set Up VFO Frequency

Turn the radio to VFO mode, by the key programmed as VFO/MR, the VFO frequency can only be set up when the channel is in the main "bold text" channel.

Operation 1: Input the VFO frequency directly by the keyboard.

Operation 2: Turn the channel selector to adjust the VFO frequency steps.

5.6 Select a Channel

Press the key programmed as **VFO/MR** to switch the radio between VFO and Channel mode, **select Channel mode**.

Operation 1: Turn the channel switch to select a channel.

Operation 2: Input the channel numbers by the keyboard. For example, if you want switch to channel 99, input 0+0+9+9 a total of 4 digits, and it will switch to channel 99.

A channel can either be Analog or Digital.

For the analog channels the Push-To-Talk button is always available, and on the Digital Channels the parameters can be set up by the users / system operators by individual channel to allow talk permit.

There are four possible settings that can be selected in the CPS channel:

(1) Always Allow: The user can transmit all the time.

(2) Channel Free: The radio can transmit only if the channel is free.

(3) Different Color Code: The radio can transmit if the channel is free, but the color code is mismatch.

5. BASIC OPERATIONS

(4) Same Color Code: The radio can transmit only if the channel is free and the color code matches.

5.7 New channel

(1) Press  (Menu) to enter main Menu.

(2) Select "Settings".

(3) Select "Chan Set".

(4) Select "New Chan".

(5) Input the channel number by keypad, press  to confirm.

(6) Select a zone from zone list, then Confirm To Save. The radio will start channel saving, and saving is completed when it displays "Saved".

(7) Now select the new channel in the radio and go to Channel Settings menu to set up all the new channel's parameters.

5.8 Delete Channel

(1) In channel (MR) mode, press  (Menu) to enter main Menu.

(2) Select "Settings".

(3) Select "Chan Set".

(4) Select "Delete Chan" to delete current channel.

5.9 Receiving and Responding to a Radio Call

When the radio is in the digital mode, it can receive and respond to a call with the same frequency/color code/ slot. When receiving a call:

- a. If the radio is programmed with callers DMR ID number in the digital contact list, when receiving a call, the radio will ring or vibrate briefly.
- b. The cyan LED lights up.
- c. The bottom of LCD shows the received signal strength(**RSSI**), and the LCD display will show DMR ID/name/city/state/country/call type and incoming icon based on what is in the contact list.
- d. When the call is ended, it will display "Call end", and you can press [PTT] to respond to the call.

5. BASIC OPERATIONS

5.10 Making a Call

Method 1: from the Channel switch.

Turn the channel switch to choose a programmed channel.

Method 2: from the Talk Group.

(1) Turn the channel switch to choose a programmed channel;

(2) Press  (exit) key to enter the TG List, press the / key to choose a TG.

Method 3: from the keypad.

(1) Turn the channel switch to choose a programmed channel.

(2) Press  (Menu) key to Talk Group, press select to enter TG.

(3) Press / key to Manual Dial, press Select.

(4) Input the ID number by keypad, press  key to switch group ID or Private DMR ID.

Hold the radio vertical 2.5-5cm from your mouth, press the [PTT] key to start the call, the red LED lights up, the receiver ID/name/city/state/country/call type and call out icon will be display on the LCD if the digital database is up-to-date in the radio.

Release [PTT] key to receive the reply.

5.11 Monitor

In standby, press the key programmed as Monitor to enter Monitor. When receiving matched carrier but the signaling / ID is unmatched or the signal is too weak, this function allows monitor the weak signal and signal with unmatched ID.

Press the key again to shut off speaker and return to standby.



» **When in analog mode, if no signal, it will emit a noise when pressing the Monitor Key.** ** *The Rx icon is seen when monitor is activated.*

5.12 Emergency Alarm

Press the key programmed as Alarm to turn alarm function, then press this key again to return to normal operation.



5.13 Battery Voltage Test

Press the key programmed as Voltage function to check the current battery voltage, press this key again to return.



6. ADVANCED FEATURES

6.1 Access Advanced Features for Private Calling

Method 1: To Access a Private Call from the Contact list

- a. Press the  (Exit) key to enter the Talk Group, press the / key to a private DMR call ID name.
- b. Press Select to View Contact, press Select to see the contact information.
- c. Press Option to access the advanced features.

Method 2: Access from Manual Dial

- a. Press the  (Menu) key to enter Talk Group, press / key to Manual Dial.
- b. Press Select to enter Manual Dial.
- c. Input the Private DMR ID, press Option to access the advanced features.

6.2 Set Up Advanced Features for Private Calling

6.2.1 Call Alert

Select Call Alert, it will send out a call alert, the target radio will sound a beep or vibrate when receiving the call alert, and it will return a success call or failed call message to the transmit radio.

6.2.2 Remote Ranging

Select Remote Ranging, and it will send out a signal for the target radio will turn on its microphone and transmit when receiving the signaling, it will send back the voice to the transmit radio. With this feature you can monitor the sound activity near the target radio remotely.

6.2.3 Get GPS info(optional)

Select Get GPS info, and it will send out a signal to the target radio which will start the GPS positioning and send a message of its GPS position to the transmit radio.

6.2.4 Check Radio

Select Check Radio, and it will send out a radio check to the target radio which will send back a message if it is available or not available to the transmit radio. With this feature, you can determine if another radio is active and powered on in the system.

6. ADVANCED FEATURES

6.2.5 Kill

Select Kill, and it will send out a kill signaling to the target radio which will be killed (No display, no operation) when receiving the signaling and it will send back a kill successful message to the transmit radio.

6.2.6 Wake

Select Wake, and it will send out a wake-up signaling to the killed radio and the target radio will return to standby when it receives this signaling and send back a Wake successful message to the transmit radio.

6.2.7 Ranging(optional)

When caller and receiver both GPS positioned, if the caller turn on ranging function and the receiver is within communication range, transmit radio will detect the distance and direction between two radios at fixed interval, and then show the information on the display of transmit radio.

7. MAIN MENU FUNCTIONS

7.1 Talk Group

TG List: Will display the talk group (TG) list which has been programmed in the PC software. This list is used as a look-up table to display the contact TG information when receiving a call.

New Contact: Allows to create a new TG.

Manual Dial: Input the group ID or private DMR ID to access a TG quickly.

Talker Alias: Allows Alias transmit Set / Alias receive Set.

7.2 SMS

New Msg: Create a new message and send to a contact.

InBox: Shows all the received messages, and allows forward or delete the message.

OutBox: Shows all the sent messages, and allows resend, forward or delete of the message.

Quick Text: Pre-saved messages, and allows to send, edit or delete the message.

Draft: Draft messages, and allows send, edit or deleting of the draft message.

7.3 Call Log

Last Call: The Last Call List show the last caller DMR ID and time information. It allows you to save the last caller as a new contact if it is not in your contact.

Sent: The Sent List shows sent messages until selected and deleted.



Answered: Shows all the answered calls, and allows deleting the call record or saving the DMR ID as a new contact.

Missed: Shows all the missed calls, and allows deleting a call record or saving the DMR ID as a new contact.

7.4 Zone

7.4.1 Select a Zone

A Zone is a group of channels grouped together. GD-168 DMR radio has 250 Zones. A Zone can have the maximum of 160 analog and/or digital channels.

Operation 1: Press  /  directly to switch the zone, the LCD will display the selected zone number or name.

Operation 2:





(1) Press  (Menu) to enter main Menu.

(2) Select "Zone".

(3) Select a zone from the zone list, radio will change to the selected zone.

7. MAIN MENU FUNCTIONS

7.4.2 Add Zone

- (1) Press  (Menu) to enter main Menu.
- (2) Select "Zone".
- (3) Select "Add Zone".
 1. Select "Edit name"
Input zone name by keypad, press  key to delete. After edit the right name, press  to confirm and store.
 2. Select "Edit Chan"
Select "Add Chan" then Select a channel from the list.
 3. Select "Save": press  key to store the new zone.

7.4.3 Delete Zone

- (1) Press  (Menu) to enter the main Menu.
- (2) Select "Zone".
- (3) Select a Zone from the zone list.
- (4) Select Delete Zone to delete current zone.

7.5 Scan



In the PC software ➔ Public ➔ Scan list, it allows to save 250 scan lists, and to program the required scan lists and write it into radio.

Switch the radio to channel mode, as the scan list is only valid in the channel mode.

7.5.1 Turn On Scan

- a. Press  (Menu) to enter the main Menu.
- b. Select "SCAN".
- c. Select "Scan ON/OFF".
- d. Select "ON", the radio will start scan, press any key to stop scan.

7.5.2 Scan List Operation

- a. Press  (Menu) to enter the main Menu.
- b. Select "SCAN".
- c. Select "Scan List".
- d. Select a scan list and press  to enter scan list sub menu.

Select Add Scan List to enter Sub Menu

1) Select Cur Chan, and press  to add current channel to active list.

2) Add Channel into Scan List

Select "Add Chan", then select "channel X" to add it into scan list.

7. MAIN MENU FUNCTIONS

3) Edit Scan List Name

Select "Edit Name". Input or revise the name and press confirm to store.

4) Store List

5) Delete Channel from Scan List

Select "Channel X", then select "Delete CH" to remove it from scan list.

7.5.3 Add Scan List

a. Press  (Menu) to enter the main Menu.

b. Select "SCAN".

c. Select "Scan List".

d. Select "Add Scan List"

e. Select "Add Chan", to add wanted channels into new scan list.

f. Select "Edit Name", input the name and confirm.

g. Select "Store List" to save new list.

7.6 Roaming

Roaming function enable users to search the roaming channel list by a programmed time interval and lock onto the repeater with the strongest signal.

7.6.1 Roaming On/Off

Allow you turn on the roaming manually. After the roaming is finished, it will return to the off state. *** Manually Roaming is a onetime action only.*

7.6.2 Roaming Zone

Select **Roam Test Zone**: select a Roaming Zone from the list to set it as active zone. You can also scroll down the list of Zones and select Add Channel to add a new channel to the current Roaming Zone and set the parameters.

Select **Add Channel**: Add a new roaming channel to the current zone.

New Roam Ch: Allows you modify the RX frequency/TX frequency/CC/TS/CH name for the roaming channel. Also allow you remove the roaming channel from the zone.

Edit Name: Edit the zone name.

Select Zone: Select the roaming zone for the current channel.

Delete Zone: Delete the roaming zone from the current channel.

7.6.3 Auto Roaming Settings

Set the fixed time waiting interval to begin automatic roaming when the repeater cannot be found, roaming will begin at the end of this time.

Fixed Time Set: The roaming will be started at preset fixed time or set to off.

7. MAIN MENU FUNCTIONS

Start Roaming:

Fixed Time: Starts timed roaming

Out of Range: The roaming will be started when the radio cannot find a repeater - "The repeater is out of range" icon will appear 3 times, then the radio will perform roaming one time, and return to roaming being off automatically.

7.6.4 Repeater Check - Off / On

Turn on this function will allow the radio to check the repeater status, the "Repeater is out of range" icon shows if the repeater is not in range.

7.7 Settings

7.7.1 Radio Set

1.Voice Func

(1) Beep Tone

Beep On: The radio will beep when you press the keypad.

Beep Off: No beep when you press the keypad.

(3) Digi Idle

Set on if you want a tone when the digital channel is free.

(4) Ana Idle

Set on if you want a tone when the analog channel is free.

(5) Startup Sound

Set On if you want a tone when powering on.

(6) Talk Permit

Select if you want a tone confirming Digital and/or Analog repeater connection at the start of a call.

(7) D-Reset Tone

Select Off or On, digital call has a group call hold time and a private call hold time to prevent the voice missing after the call. When set Digi Call Reset Tone is On, it will beep when the hold time terminates.

(8) Max Vol Level

Indoor: Very low volume, suitable for the indoor use.

Level 1-8: Adjustable and set up the maximum volume level.

(9) Headset Max Vol

Indoor: Very low volume, suitable for indoor use.

Level 1-8: Set up the maximum volume level for earphone. When the radio connect with earphone, it will automatically change to earphone maximum volume.

7. MAIN MENU FUNCTIONS

(10) MIC Sound

It will allow you set up the microphone audio pitch.

Normal: Low pitch.

Enhance: High pitch.

(11) SMS Prompt

Different prompt options when receiving a new message.

(12) Call Ring

Different prompt options when receiving a new call.

(13) DigiMic Level

Digital mic level selection.

Level 1-5: Adjustable in 5 levels, the level 1 has softest TX digital audio and the level 5 has loudest TX digital audio.

Auto: It helps to make the TX digital audio similar, the loud audio will be reduced and the soft audio will be amplified.

(14) AnaMic Level

Analog mic level selection.

Level 1-5: Adjustable in 5 levels, the level 1 has softest TX analog audio and the level 5 has loudest TX analog audio.

Auto: It helps to make the TX analog audio similar, the loud audio will be reduced and the soft audio will be amplified.

(15) Fix Time Mute

With the "**Fix Time Mute**" function activated (On) it is possible to mute the loud speaker for special time segment.

The duration of the "**Mute Time**" may be set by the CPS ➔ Optional Setting ➔ Other ➔ Mute Timing.

(16) TX NR

Enabling the TX noise reduction function can reduce background noise and ambient noise in transmitted audio.

(17) Ana RX NR

Enabling the RX noise reduction function can reduce background noise and ambient noise in received analog audio.

(18) RX AGC

Enable the RX AGC function, it helps to make the RX audio similar, the loud audio will be reduced and the soft audio will be amplified.

2.Display Func

(1) Back Light

LCD backlight intensity is adjustable in 5 steps

7. MAIN MENU FUNCTIONS

(2) Night Mode

With this function ON, and when the radio is in standby, it will reduce the backlight to level 1, no matter what is the backlight brightness setting.

(3) Light Time

Always: The backlight is always on.

5Sec-5Min adjustable.

Note: This function is valid when turning off the power save.

(4) Ch. Name

CH name: The radio will work in channel mode and display the channel name, and then the programmed VFO/ MR key is not valid.

Frequency: The radio will work in VFO mode and display the frequency, which allows the programmed VFO/MR key to switch the VFO and Memory channels.

(5) Language

Choose the Chinese or English.

(6) Menu Exit Time

5Sec-60Sec: When enter the menu, the radio will stay at the menu in the set time. When the time is reached, the radio will auto exit the menu.

(7) Start Display

Picture: The radio will display an Radioddity picture when powered on.

Character: The radio will display the characters set up in PC software when powered on.

Customer's Pic: The radio will display the picture uploaded by PC software. In CPS ➔ Tool ➔ Boot Image, it will allow you to upload a Power-on Picture in .bmp or .jpg format, the resolution of the picture shall be 128*160.

(8) CH Background

Default Picture: In standby, the radio will display the default picture.

Customer's Pic: The radio will display the picture uploaded by PC software. In CPS ➔ Tool ➔ Standby BK Picture, it will allow you upload a standby background picture.

(9) CHG Font Color

Set the text color of the standby interface. Total of 8colors available for selection.

(10) CH Color A

Set color for the band A channel display.

(11) CH Color B

Set color for the band B channel display.

(12) Zone Color A

Set color for the band A zone display.

(13) Zone Color B

Set color for the band B zone display.

7. MAIN MENU FUNCTIONS

(14) Main Ch

Channel A: The upper displayed channel will be set to become the main channel.

Channel B: The lower displayed channel will be set to become the main channel.



(15) Sub Ch Off



Sub Channel On: Turns on the sub channel, and the radio will display both channel.

Sub Channel Off: Turns off the sub channel, and the radio will display the main channel only.

3.Key Func

(1) Key Lock

Manual Lock: Long press the  key to lock the keypad. Press  key, then press the  key to unlock the keypad.

Auto Lock: Radio will auto lock the keypad when standby for a while. Press  key, then press the  key to unlock the keypad.

Note: To get the key lock function working, some options should be set ON in CPS ➔ *Optional Setting* ➔ *Key function first*.

Knob Lock: Set On to lock the knobs.

Keypad Lock: Set On to lock the keypad.

Side Key Lock: Set On to lock the PF1,PF2.

Forced Key Lock: Set On to prevent the key from unlocked. When this function is ON, the keys are not able to unlock manually.

(2-11) Key PF1, PF2

PF1 key and PF2 key are programmable, it allows you assign the key as short, Long1 or Long2 function. Please refer to page 10&11 for the key functions.

Short: Click on the programmed key to activate the assigned function.

Long 1: Hold pressing the programmed key until the radio emits a "Du" beep, release the key to activate the assigned function.

Long 2: Hold pressing the programmed key, do not release the key even when the radio emits the "Du" beep, the radio will activate the assigned function.

4.Other Func

(1) Auto Power Off

Allow to set automatic power off when not used for a period of 10 minutes, -120minutes

Off: Turn off the function.

(2) TX Timer

30Sec-240Sec: The TX will be limited for the set time. When this time is reached, the radio will auto stop transmission.

OFF: Turn off the TX time limit, and there is no limit for the transmission time.

(3) TOT (Transmitter Out Timer) Predict

7. MAIN MENU FUNCTIONS

With the "TOT Predict" function activated (On), 5 seconds before the TOT expiring, a beep sound is preventing that soon the transmitting mode will be interrupted.

(4) TxPow AGC (Automatic Level Control)

With the "TxPow AGC" function activated (On), while receiving extremely strong signal, the TX power will automatically reduce the level of the TX Power proportionally to the strength of the RX signal.

(5) Freq Step

2.5K,5K,6.25K,8.33K,10K,12.5K,20K,25K,30K,50K, total of 9 frequency steps.

(6) Ana SQ Level

Adjusts the squelch level to receive signal with different signal strength, and a total of 5 levels offered. This function is only valid for analog channel.

(7) Power Save

Turn on the function to extend the battery life.

Save 1:1, work 30ms, dormant 30ms.

Save 2:1, work 60ms, dormant 30ms

When turn on the power save, it may not receive the message in time.

(8) TBST Sel

TBST frequency is used to activate some dormant repeaters, 1000Hz, 1450Hz,1750Hz, 2100Hz a total of 4 options are offered.

Press PTT and PF1 key together to transmit the TBST tone.

(9) VOX

Enable the VOX, you can speak into the microphone to start transmitting instead of pressing the [PTT] key. A total of 3 levels are provided.

(10) VOX Delay

When the VOX is enabled, set up the VOX delay to help to extend the transmission time to avoid stopping a transmission too early. 0.5sec-3sec , a total of 26 times offered.

(11) Scan Mod

SCM TO: When scanning and stopping for a signal, stays at the channel 5sec before resuming the scan.

SCM CO: When scanning and stopping for signal, stays at the channel until the signal disappears, and resumes scan 2sec later.

SCM SE: When scanning and stopping for a signal, will terminate the scan. This function is only valid for a VFO scan.

(12) DTMF Speed

Offers DTMF encode speed which will help the receiver decode successfully, 50~500ms are the options.

7. MAIN MENU FUNCTIONS

(13) FM Radio

Turn on or off the FM radio.

(14) FM Radio Moni

Radio Mon On: When FM radio is used, you can still receive or transmit on the channel.

Radio Mon Off: When FM radio is used, the radio will not permit a transmission or reception.

(15) Start Up Pwd

On: Set up the password for start up. You need to input the password to power on the radio.

Off: No password is required for the radio power on start up.

The password shall be set up in CPS ➔ Optional Setting ➔ Power on ➔ Power ➔ on Password Char.

(16-17) AuRepeater A or B (For VFO A or B)

Turn on the Auto Repeater function, the TX frequency in VFO mode will auto increase or reduce frequency base on the set up offset frequency in CPS.

Off: Turn off the function.

Positive: TX frequency= RX frequency + Offset frequency.

Negative: TX frequency= RX frequency - Offset frequency.

(18) Weather Alarm (only US version)

Turn On or Off the Weather Alarm function.

(19) SMS Format

M-SMS: Allows SMS text communication with Motorola DMR radio.

H-SMS: Allows SMS text communication with Hytera DMR radio.

DMR Standard: Allows SMS text communication with radios set SMS in ETSI DMR standard format.

(20) CTC Ste (Squelch Tail Eliminate)

Tail eliminate is valid for simplex radio to radio only.

At the end of the analog call, the radio will beep 'chap' noise when detect there is no signal, and then turn the audio off.

In order to avoid hearing the noise, you can set this function for the analog channels with CTCSS signaling.

(21) DCS Ste(Squelch Tail Eliminate)

Tail eliminate is valid for simplex radio to radio only.

At the end of the analog call, the radio will beep 'chap' noise when detect there is no signal, and then turn the audio off.

In order to avoid hearing the noise, you can set this function for the analog .

(22) No-Signal Ste

7. MAIN MENU FUNCTIONS

Tail eliminate is valid for simplex radio to radio only.

At the end of the analog call, the radio will beep 'chap' noise when detect there is no signal, and then turn the audio off.

In order to avoid hearing the noise, you can set this function for the analog channels without signaling.

(23) Time Zone

Set up the time zone of your location.

(24) Time Display

Set On to show the date/time on the display.

Set Off to hide the date/time on the display.

(25) Date Time

Time Set: Allows to set up the date and time manually. Use the \uparrow/\downarrow key to set the current year. Move to the month by pushing the **[PF1]** key. Set the month, and use the **[PF1]** key to move forward each step. Once done, click the Menu key to save the date and time.

GPS Check(optional): When the GPS is positioning successfully, enter this menu, select GPS check to do the date & time correction automatically.

Format: Set the date display format to yy/mm/dd or dd/mm/yy.

(26) TxPreamble

The radio transmits preamble before data, SMS or private call is sent. This is useful to wake up the receiver from battery-saving mode or stop the receiver from scanning before transmitter sending the data.

This settings allows to set the duration of the preamble transmission.

(27) Header RPT

Before the voice packet is transmitting, the radio will send a voice header with Group Call identification packet first.

Repeat sending voice header will help to synchronize the receiving radio and improve the success rate of communication. This setting allows you set the voice header repeat times.

(28) CRC ignore

Set ON to enable the DMR CRC ignore function.

It allows the DMR vocoder selectively ignore the CRC result of Voice LC Header, and the radio can receive more signals.

7.7.2 Chan Set

Channel set menu Route: Main Menu \rightarrow Settings \rightarrow Chan Set. The channel set menu will change accordingly to the channel type. When the channel type is digital, it will automatical hide the analog menus..

7. MAIN MENU FUNCTIONS

※ Chan Set (Digital Channel)

(1) New Chan

Allows to create a new channel and save the set up to the new channel.

- Select "**New Chan**", then input new channel number and confirm.
- Input channel name and confirm.
- Select a zone and confirm. The new channel will be saved to the selected zone.

(2) Delete Chan

Allows to delete the current channel.

- Select "**Delete Chan**", the radio will remind "**Delete?** "
- press confirm, and the current channel will be deleted.

Note: After deleting one channel, the radio will move to the next channel.

(3) Channel Type

A-Analog : Set up to analog channel

D- Digital : Set up to digital channel

A+D TX A: Mixed analog, allow receive analog and digital signal, TX is analog.

D+A TX D: Mixed digital, allow receive analog and digital signal, TX is digital.

(4) TX Power

Set up the TX power for current channel.

(5) Offset

Press  /  to adjust offset frequency.

(6) Band Width

Only narrow band 12.5KHz for digital channel.

(7) RX Freq

Input the RX frequency by keypad, click the Menu key to save, press [Exit] key to return.

(8) TX Freq

Input the TX frequency by keypad, click the Menu key to save, press [Exit] key to return.

(9) Talk Around

When the TX radio and RX radio both are set up with Talk Around on, they can communicate directly without a repeater. The analog channel will use the RX frequency as TX/RX frequency, the RX CTCSS/DCS decode as TX CTCSS/DCS encode.

(10) Name

Allows to reset the channel name, this function is only valid in channel mode.

(11) TX Allow

Always: Always allow transmit

7. MAIN MENU FUNCTIONS

Channel Free: Allow transmit when the channel is free

Different CC: Allow transmit when receive matched signal but different color code.

Same CC: Allow transmit when receive matched signal and same color code.

(12) TX Prohibit

TX ON: Will allow transmit on the current channel.

TX OFF: Will not allow transmit on the current channel.

(13) Radio ID

In Digital channel, it will show the DMR ID which must be programmed in the PC software ➔ Digital ➔ DMR ID list ➔ DMR ID. Allows edit and select an ID for the channel, each channel allows one DMR ID.

In Analog channel, it will show the radio 5Tone self ID or DTMF self ID which is programmed in the PC software ➔ Analog ➔ 5Tone Self ID or DTMF Self ID.

(14) Color Code

The digital channel should have the same color code for communication as defined by the repeater to be used; which can be programmed in the PC software(CPS) or defined in the Menu.

(15) Time Slot

Set up Slot 1 or Slot 2 for the current channel.

(16) Digi Encrypt

With the digital encryption, the communication will be confidential. A total of 32 digital encryptions is offered, and it can be programmed in the PC software(CPS) or defined in the Menu.

(17) Encrypt Type

Choose normal encryption or enhanced encryption type.

(18) RX Group List

It will allow edit the RX Group List and assign a new RX Group List to the channel.

Select Cur List: Select the current RX Group List.

Add Group: Add a TG to the current RX Group List.

Remove Group: Remove a TG from the current RX Group List.

(19) Work Alone

In the PC software ➔ Public ➔ Alarm settings ➔ Work Alone, you have to set up the response time, warning time and response method initially.

Turn on the work alone function for the current channel. When the radios predetermined time has been reached for the alone working time, the radio will beep a sound and show "Work Alone Predict". The user has to confirm by pushing the programmed work alone key to confirm continuing work alone,

7. MAIN MENU FUNCTIONS

otherwise, the radio will start its alarm and send the alarm on the channel when reaching its preset response time.

(20) CH Ranging

In standby, if the call contact type for a channel is "Private call", The radio will automatically start ranging function when turned to this channel. The other radio's location will be showed on screen at intervals.

(21) APRS Receive

Turn APRS Receive, if both radio GPS is positioned, the radio will display the other radio's distance and position when radio is receiving.

(22) SMS Forbid

Set On to prohibit the radio receive SMS.

(23) DataAck Forbid

Set On to ignore the repeater data service request. The radio will not reply to repeater when it receives the call confirmation/SMS confirmation request, etc..

(24) Idle TX

With "Idle TX" ON, when a repeater has one time slot occupied, the radio will automatically switch to the other time slot for transmission. If both time slots are occupied, the radio will beep to remind that it can not connect to the repeater.

Notice: When you use this function, make sure both the TX and RX radio have the "Idle TX" function turned ON.

(25) DMR Mode

Select different DMR modes for digital channel. Recommend setting is "Repeater" for normal use.

Repeater: Allows the radios communicate through repeater or hotspot, same slot for TX and RX.

DMO/Simplex: Only for the radio direct communicate use,without repeater or hotspot. Allows the channel has different TX/RX frequency as long as the other radio has the matched RX/TX frequency.

DCCDM/Double Slot: Only for the radio direct communicate use,without repeater or hotspot.The channel should have same TX/RX frequency, time slot will be used to distinguish channels, i.e you can ceate two channels at same TX/RX frequency but different time slot.

DCCDM/TS split: Allows the radios communicate through repeater or hotspot, different time slot for TX and RX use. The slot in channel is for RX use, TX will use reversed slot automatically.

7. MAIN MENU FUNCTIONS

(26) Slot Suit

Turn on Slot suit, the radio will receive calling from both slot, and will be able to call back in the corresponding slot.

※Chan Set (Available in Analog Channel only)

When the channel type is analog, it will automatically hide the digital menu, The below listed menus are for analog channel only, unlisted menus are the same as the digital channel, please refer to Chan Set (Digital Channel).

(4) TCDT

Set up the CTCSS/DCS code for the TX.

(5) RCDT

Set up the CTCSS/DCS code for the RX.

(6) RTCDT

Set up the CTCSS/DCS code for both TX and RX
CTCSS code: 62.5Hz~254.1Hz, a total of 51 groups
DCS code: 000N~7771, a total of 1024 groups.

(7) Optional Signal

Allows the setup of DTMF/5TONE/2TONE encode and decode for the Analog channels.

(10) Squelch mode

When the analog channel is set up for both CTCSS/DCS decoding and optional signaling, you can set up the RX condition in this menu.

SQ: You can hear the call once the channel receive matched carrier.

CDT: You can hear the call when receive matched CTCSS/DCS signal.

TONE: You can hear the call when receives a matched signaling.

C&T: You can hear the call when receives a matched CTCSS/DCS and matched signaling.

C|T: You can hear the call when receives a matched CTCSS/DCS or.

(11) Band Width

Choose wide band or narrow band for the analog channel.

(12) Reverse

When this function is enabled, the RX frequency, TX frequency and CTCSS/DCS encode/decode will be reversed.

(13) Compander

Enable this function to reduce background noise and enhance audio clarity, especially in long range communication.

(14) Scrambler

This special audio process can offer a more confidential communication.

7. MAIN MENU FUNCTIONS

Other radios at the same frequency will receive only the distorted noises.

(19) Busy Lock

Always: Always allows transmissions

RL: Will not allow transmit when receiving matched carrier but unmatched CTCSS/DCS.

BU: Will not allow transmit when receiving matched carrier.

(21) OWN ID

When the analog channel set up with 5Tone or DTMF, you can check the radio ID number in this menu. The ID number should be set up in PC software ➡ Analog ➡ 5Tone or DTMF self ID.

(22) DTMF Enc

Set a DTMF ID as the default call ID for the current channel.

Press the PTT key to transmit the selected DTMF ID.

Edit the DTMF ID in Menu or with the PC programming software.

(23-24) 2Tone Enc

Set a 2Tone as the default call ID for the current channel.

Press the [PTT] key to transmit the selected 2Tone.

Edit the 2Tone in the PC programming software before it can be selected.

(25) 5Tone Enc

Set a 5Tone as the default call ID for the current channel.

Press the [PTT] key to transmit the selected 5Tone.

Edit the 5Tone in the PC programming software before it can be selected.

(26) 5Tone BOT

Set ON to send the 5Tone encode ID when press the [PTT] key.

(27) 5Tone EOT

Set ON to send the 5Tone encode ID when release the [PTT] key.

(28) QDC1200

Set a QDC1200 as the default call ID for the current channel.

Press the [PTT] key to transmit the selected QDC1200.

Edit the QDC1200 in the PC programming software before it can be selected.

(29) PTT ID

To get the PTT ID working, the optional signal shall be set to DTMF or 5Tone, and the EOT/BOT in the DTMF & 5Tone page shall be set up first.

OFF: OFF

Start: Start, press PTT key to send a series of DTMF code or 5Tone code.

End: End, release PTT key to send a series of DTMF code or 5Tone code.

Start&End: Start and end, press and release PTT key to send a series of DTMF code or 5Tone code.

7. MAIN MENU FUNCTIONS

7.7.3 Device Info

Show the Radio ID, Radio name, serial number, model name, frequency range, firmware version, radio data version, latest program date, picture version, language version etc.

7.8 Record

The voice record is designed for security use purpose. Each call will be saved as a separated recording file. The standard voice allows 4 hours recording in DMR or analog mode.

7.8.1 Turn On/ Off the Recording

a. Press **[Menu]** (Menu) enter main Menu, press **[Up]** / **[Down]** key to Record.

b. Select **Record**, then

•Select **On/Off**, select on or off to turn on or off the recording.

7.8.2 Play the Record

a. Press **[Menu]** (Menu) to enter main Menu, press **[Up]** / **[Down]** key to Record.

b. Select **List** to enter Record list, select a Record list to enter the Record file.

c. Select a Record to see the Detailed Information.

d. Press Select to choose the record option.

1) **Play**, it will play one record at a time, you can press **[Up]** / **[Down]** key to switch the recording without return to previous menu.

2) **Loop Playback**, it will play all records in a loop.

7.8.3 Send the Record

a. Press **[Menu]** (Menu) to enter main Menu, press **[Up]** / **[Down]** key to Record.

b. Select Record List to enter Record list, select a Record list to enter the Record file.

c. Select a Record to see the detail information.

d. Select Send, and it will display the Contact list or Manual Dial.

e. Select Contact list to choose a contact, press select to send the Record.

f. Select Manual Dial, input the DMR ID, press **[#1]** key to switch group ID or private DMR ID, press select to send the Record.

7.8.4 Recording Manually

In the PC software, Public ➔ Optional Setting ➔ Key function, program a key as Record.

7. MAIN MENU FUNCTIONS

- a. Press the programmed Record key, and the radio will start the recording, and speak into the microphone.
- b. Select Record Play, and the radio will play the record.
- c. Select Record Send, and the radio will display Contact list or Manual Dial.
- d. Select Contact list to choose a contact, and press select to send the Record.
- e. Select Manual Dial, input the DMR ID, press **[#1]** key to switch group ID or private ID, press select to send the Record.

7.9 GPS Positioning Function(optional with installed GPS)

7.9.1 Turn on GPS

- a. Press **[Menu]** (Menu) to enter the main Menu.
- b. Select "GPS".
- c. Select "GPS On".

7.9.2 GPS Mode

Select GPS work mode for positioning use.

GPS mode is US Global Positioning System.

BDS mode is China BeiDou Navigation Satellite System.

GLONASS mode is Russia GLONASS Navigation Satellite System.

7.9.3 GPS Roaming

GPS Roaming function allows the radio auto switches to a zone when GPS positioning is within the preset radiation radius of coordinates.

To get this function working, you need to set the GPS roaming page in the CPS first.

7.9.4 GPS Info

Method 1: Check GPS info from Menu

Press **[Menu]** (Menu) key to enter Main Menu, select "GPS", then select "GPS Info".

Method 2: Check GPS info from programmed key

In the PC software, Public ➔ Optional Setting ➔ Key function, program a key as "GPS Info", then press the programmed key to check the GPS info.

 **NOTE** » If the GPS is not positioning, it will display “No Fixed Position”, and the GPS icon shows a grey color. Move the radio to an open window or outdoors, and it will take a few minutes to connect to the GPS Satellites.

7. MAIN MENU FUNCTIONS

7.9.5 Send GPS Information

- a. When the GPS is positioning successfully, the GPS icon shows a red color. Follow the above step to check the GPS info, press the edit key to Text edit.
- b. Press Confirm, and it will display Send or Save. If you select Save, the GPS info will be saved as a draft message.
- c. Choose Send and it will display Contact list or Manual Dial.
- d. Select Contact list to choose a contact, press select to send the GPS info.
or
- e. Select Manual Dial, input the DMR ID, press **[#1]** key to switch group ID or private ID, press **[]** to send the GPS info.

7.10 Satellite

This feature allows the radio to communicate with the satellite during its transit.

7.10.1 Location

GPS: The satellite function is depending on GPS location.

Fixed: The satellite function is depending on the fixed location beacon, which you need to set up in CPS-APRS page first.

7.10.2 Satellite

The radio will provide a predict list for the satellites which will transit recently. Select a satellite to check the frequency and transit time. Press PTT button to transmit to the satellite.

7.11 APRS Location Reporting(Optional, supported by GPS)

7.11.1 Upload Type

None: No APRS.

Sel A Aprs: Select analog APRS.

Sel D Aprs: Select DMR APRS.

7.11.2 Ana APRS

PTT Upload: Set the PTT transmit method.

- Off: Not transmit APRS.
- Tx Start: Transmit analog APRS when press the PTT.
- TX End: Transmit analog APRS when release the PTT.

TX Power: Set the transmit power.

Band Width: Set the band width for transmitting.

TX frequency: Set the transmit frequency.

7. MAIN MENU FUNCTIONS

Signal Path: Set the WIDE format signal path.

TX Text: Set the text to be shown on the <https://aprs.fi> website.

7.11.3 Digi APRS

PTT Upload: Set the PTT transmit method.

- Off: Not transmit APRS.
- On: Transmit DMR APRS when release the PTT.

Report Channel: Allow user to select a channel to transmit the DMR APRS, please set the 8 report channels in CPS-APRS-Digi page first.

Upload Slot: Allow user to select a slot to transmit the DMR APRS.

- Channel Slot: It uses the slot of current channel
- Slot 1: Use slot 1
- Slot 2: Use slot 2

Upload ID: Allow user to set a DMR ID to receive the DMR APRS, it can be a private ID or a group ID.

7.11.4 Digi APRS Info

The received APRS information will be saved in the radio for look back use.

Click on "Digi APRS Info" will show the received APRS information.

Click on "Delete All" will clear the information.

7.11.5 Intervals Set

This function allows you to set the analog APRS or DMR APRS auto transmit at fixed times.

7.11.6 Beacon

GPS Beacon: The APRS will transmit the GPS data, only if the GPS is set to on first, then GPS must also successfully lock on the satellites.

Fixed Beacon: The APRS will transmit the fixed beacon data. Someone can transmit the fixed beacon without setting the GPS on. The fixed beacon location information should be set in CPS first.

Note: More setup are available by the PC software. **CPS-Tools-Options-APRS**, you have to check the APRS box first to get APRS menu added to the left Digital menu.

(APRS is a registered trademark of Bob Bruninga, WB4APR)

7. MAIN MENU FUNCTIONS

7.12 Digital Monitor

- a. Press **[Menu]** (Menu) key to enter main menu, press **[Up]/[Down]** key to choose **Digi Moni** function.
- b. Press Select to enter **Digi Moni** menu, press **[Up]/[Down]** key to choose a sub menu.
- 1) **On/Off**
Off: Turn off Digital Monitor
Single Slot: Monitor the current Slot
Double Slot: Monitor Slot 1 and Slot 2
- 2) **DigiMoni Cc**
Any Cc: Monitor any color code
Same Cc: Monitor the same color code
- 3) **DigiMoni Id**
Any Id: Monitor any TG
Same Id: Monitor the same TG
- 4) **Slot Hold**
Off: Turn off the slot hold
On: Turn on the slot hold
Recommend to turn on slot hold when monitor double slot (Slot 1 and Slot 2), when the signal disappears in one slot, instead of switching to the other slot at once, the radio will hold for some seconds and wait for the audio drop.
- c. Press Select to enter the sub menu and set up.

7.12.1 Response and Save a call in Digital Monitor Mode

During Digital Monitor, when receiving a call with unmatched ID, press **[*]** key, the screen will display "*Monitor Response Setup Successfully*", press [PTT] key will reponse to the call.

Press **[#1]** key, the radio will remind you choose a Zone, press **[Up]/[Down]** key to choose a Zone, press select key to save the new channel to the Zone.

8. RESET

- a. Power off the radio first to start the reset function.
- b. Then power it on while holding the [PTT] and the [PF1] button below the PTT at the same time.
- c. The radio will start up with a note on the display – “Are you sure you want to initialize radio?”

Press Exit to exit the reset and power on the radio.

Press Confirm to proceed the reset, it will come with a screen display note displaying – Initialize Radio.

- d. After a re-start the radio will display the setting of time zone and the date and the time. Use the up-down key to set the current year. Move to the month by pushing the **PF1** key. Set the month, and use the **PF1** key to move forward each step. Once done, click the Confirm key to save the date and time.

Please remember set up the time zone to avoid the date/time error.



Make sure the codeplug is saved to the PC(CPS) before you do the update and reset. The codeplug will be eliminated and needs to be installed in the radio.

9. TROUBLE SHOOTING GUIDE

Problems	Solutions
The radio cannot be switched on or no display after being switched on.	<ul style="list-style-type: none">A. Battery pack may not be installed properly. Remove the battery pack and install it again.B. Battery power may be insufficient. Recharge or replace the battery pack.
The battery doesn't last very long after charging.	The battery is defective; please replace it with a new battery pack.
Cannot talk to or hear other members in your group.	<ul style="list-style-type: none">1. Make sure the frequency and CTCSS are the same as other members.2. Make sure you are within range, and not too far away from your member.3. Make sure you are set in correct digital mode, and frequency.4. In digital mode, make sure to set correct code and encrypt group is used in current channel.5. In digital mode, make sure to set correct receiving contacts and receiving group to be used.
Other voices from non-group members are heard on the channel.	Analog: Change the CTCSS/DCS Tone, and make sure to change the tone on all radios in your group.

10. PROGRAMMING GUIDE

Radioddity GD-168 radios ship from the manufacturer “Keypad” locked per FCC rules.

You can press the  (Menu) key and the  (star) key to unlock the keypad for the first time of use. You will need the programming cable to connect your radio to your computer and the CPS software for programming.

The programming software and codeplug programming guide are available for download from Radioddity website: www.radioddity.com

When programming this radio for the first time, it is recommended you first READ the radio with the software and then save this file for future reference as it contains the default programming and settings. In addition, after you READ this radio with software, first make your programming and frequency changes, then send this edited file back to your radio.

Multiple Radio ID's

The GD-168 radio will allow multiple DMR Radio ID numbers to be used with the radio. This feature will allow one radio to be used for example as a Commercial Radio with its own DMR ID, and at the same time also be used as an Amateur radio with another DMR ID.

In the PC software, Digital/ Radio ID List, you can enter your Department Unit Number or Amateur Radio callsign.

Amateur DMR-MARC

For the best Amateur DMR experience obtain a subscriber ID from one of many available Amateur Radio sources. A U.S. Amateur can obtain a DMR ID From:

<https://www.radioid.net/cgi-bin/trbo-database/register.cgi>

For DMR repeaters in your area please see: www.repeaterbook.com

World DMR repeater network map:

<https://www.repeaterbook.com/index.php/repeater-database>

World DMR repeater network with verified Talkgroups by activity:

<https://brandmeister.network/?page=lh>

Worldwide Amateur Contact Database

The GD-168 DMR radios contain a separate database memory for importing and displaying Amateur DMR individual IDs, call sign and user name in comma-delimited format (.csv)

Please reference in the programming guide for import and export database operations detailed.

User List Contact Database: <https://ham-digital.org/status/>

11. ON-LINE SERVICE AND SUPPORT

The Radioddity website provides additional information about obtaining service or support for the Radioddity line of two-way radios and accessories. Visit: www.radioddity.com

Warning Notes

Every effort has been made to ensure that the information in this document is complete, accurate, and up to-date. Radioddity Radio assumes no responsibility for the results of errors beyond its control. The manufacturer of this equipment also cannot guarantee that changes in the equipment made by non-authorized users will not affect the information in it.

FCC Licensing Information

This Radioddity radio operates on Commercial / Land Mobile frequencies which require a license from the Federal Communications Commission (FCC) for business, personal, education and recreational use. To obtain forms, call the FCC forms hotline at: 1-800-418-3676 or go to <http://www.fcc.gov>

For questions concerning commercial licensing, contact the FCC at 1-888-CALL-FCC (1-888-225-5322).

SAFETY

The Radioddity GD-168 DMR handheld transceiver has been carefully designed to provide you with years of safe, reliable operation. As with all electrical equipment, however, there are a few basic precautions you should take to avoid hurting yourself or damaging the radio:

- Read the instructions in this handbook carefully. Be sure to save it for future reference.
- Read and follow all warning and instruction labels on the radio and in the owner's manual.
- Do not carry the transceiver by the antenna. This may damage the antenna or antenna terminal. Grasp the handheld by its base (not the antenna) when you need to place or remove it.
- Do not keep the radio with the antenna very close to, or touching exposed parts of the body, while transmitting. Radioddity radios will perform best, if you speak 2-4 inches away from the microphone and the radio is vertical.
- Be sure the "PTT" key is not pressed when you do not need to transmit.
- Do not operate the radio near unshielded electrical blasting caps or in an explosive atmosphere.
- Do not transmit without the antenna fitted on the radio. Though it is provided with a protection, it may damage the TX output final stage.
- Respect the environment conditions. The radio is designed to be used in heavy environments, however avoid exposing it to extremely hot or cold temperature (out of the range between -20°C to $+55^{\circ}\text{C}$). Do not expose the transceiver to excessive vibrations as well as dusty or rainy locations.
- Never try to disassemble or service the radio by yourself (aside from the routine maintenance described in this handbook). It may cause damage to the radio transceiver and void your warranty requiring extensive repair work. Always contact your local dealer for assistance.
- Use only authorized accessories. Using non Radioddity radio brand accessories may seriously damage your handheld transceiver and void your warranty.
- Do not spill liquid of any kind into your radio. If the transceiver gets wet, immediately dry it by a soft and clean cloth.
- Switch the radio off before you clean it. Follow the directions described in the paragraph "Care and maintenance".

SAFETY

- Handle the battery properly. Never place the LI-ion battery in your pocket or purse with loose coins. This could result in short circuiting the battery.
- Be certain that your power source matches the rating listed for the supplied battery charger (AC adapter). If you are not sure, check with your authorized Radioddity dealer.
- Avoid damaging the power cable of the battery charger. Do not step on or place anything on it as this could result in a damaged charger power cord. This product complies with the requirements of the Council Directives 89/336/EEC and 73/23/EEC on the approximation of the laws of the member states relating to electromagnetic compatibility and low voltage.

WARNING

Your wireless hand-held portable transceiver contains a low power transmitter. When the Push-to-Talk (PTT) button is pressed it sends out radio frequency (RF) signals. The device is authorized to operate at a duty factor not to exceed 50% TX and 50% RX.

In August 1996, the Federal Communications Commission (FCC) adopted RF exposure guidelines with safety levels for hand-held wireless devices. To maintain compliance with the FCC's RF exposure guidelines, this transmitter and its antenna must maintain a separation distance of least 2 inches from your face. Speak in a normal voice, with the antenna pointed up and away from the face at the required separation distance. The belt clip is for storage purposes only.

AVOID TRANSMITTING ON HIGH POWER WHILE RADIO IS ATTACHED TO YOUR BELT. To transmit, hold the device away from your body and ensure the antenna is at least 2 inches from your body when transmitting.

12. TECHNICAL SPECIFICATIONS

General		
Frequency Range	US: 136-174MHz, 400-480MHz	
Channel Capacity	4000 channels	
Channel Spacing	25KHz (Wide Band) , 12.5KHz (Narrow Band)	
Phase-locked Step	5KHz, 6.25KHz	
Operating Voltage	7.4V DC \pm 20%	
Frequency Stability	\pm 1.5ppm	
Operating Temperature	-20°C ~ +55°C	
Size	103.5×53.5×35.5mm (with battery pack)	
Weight	224g (with battery pack)	
Receiving Part		
	Wide band	Narrow band
Sensitivity(12dB SINAD)	\leq 0.25 μ V	\leq 0.35 μ V
Digital Sensitivity	0.3uV/-117.4dBm (BER 5%) 0.7uV/-110dBm (BER 1%)	
Adjacent Channel Selectivity	\geq 65dB	\geq 60dB
Spurious Emission	\leq -57dB	\leq -57dB
Spurious Rejection	\geq 65dB	\geq 60dB
Blocking	84db	
Hum & Noise	\geq 45dB	\geq 40dB
Audio Distortion	\leq 5%	
Audio Power Output	1000mW/16 Ω	
Transmitting Part		
	Wide band	Narrow band
Power Output	VHF: 5/2.5/1W/0.2W, UHF: 4.5/2.5/0.5W/0.2W	
Modulation	\pm 5.0KHz@25KHz	\pm 2.5KHz@12.5KHz
Adjacent Channel Power	\geq 70dB	\geq 60dB
Hum & Noise	\geq 40dB	\geq 36dB
Spurious Emission	\leq -60dBc	\leq -60dBc
4FSK Digital Modulation	12.5KHz (data) 7K60FXD 12.5KHz (data+voice) 7K60FXE	
Audio Distortion	\leq 5%	
Error rate	\leq 3%	

European Users should note that operation of this unit in Transmit mode requires the operator to have a valid Amateur Radio Licence from their respective Countries Amateur Radio Licencing Authority for the Frequencies and Transmitter Power levels that this Radio transmits on. Failure to comply may be unlawful and liable for prosecution. *At this subject, refer to the "EU" specification guide 2014/53/EU.*

Disposal of your Electronic and Electric Equipment

Products with the symbol (crossed-out wheeled bin) cannot be disposed as household waste. Electronic and Electric Equipment should be recycled at a facility capable of handling these items and their waste by products.

In EU countries, please contact your local equipment supplier representative or service center for information about the waste collection system in your country.



IMPORTANT NOTICE TO THE ENDUSERS:

The European version of these devices is intended for amateur radio use only. It operates on the following bands:

VHF = 144-146 MHz

UHF = 430-440 MHz

The operator must have the appropriate licence. Any manipulation of the aforementioned frequency bands is prohibited.

WICHTIGER HINWEIS FÜR DEN ENDBENUTZER:

Die europäische Version dieser Geräte ist nur für den Einsatz im Amateurfunk vorgesehen. Es arbeitet auf den folgenden Bändern:

UKW = 144-146 MHz

UHF = 430-440 MHz

Der Betreiber muss über die entsprechende Lizenz verfügen. Jegliche Manipulation der vorgenannten Frequenzbänder ist untersagt.

AVIS IMPORTANT AUX UTILISATEURS FINAUX:

La version européenne de ces appareils est destinée uniquement à une utilisation dans le domaine radioamateur. Il fonctionne sur les bandes suivantes:

VHF = 144-146 MHz

UHF = 430-440 MHz

L'opérateur doit avoir la licence appropriée. Toutes les manipulations de les bandes de fréquences précitées sont interdite.

AVVISO IMPORTANTE PER L'UTENZA FINALE:

La versione europea di questi apparati è destinata esclusivamente all'uso radioamatoriale. Esso opera sulle seguenti bande:

VHF = 144-146 MHz

UHF = 430-440 MHz

L'operatore deve possedere la licenza appropriata. Qualsiasi manipolazione delle suddette bande di frequenza è interdetta.

AVISO IMPORTANTE A LOS USUARIOS FINALES:

La versión europea de estosequipoestá diseñada para uso exclusivo de radioaficionados. Opera en lassiguientesbandas:

VHF = 144-146 MHz

UHF = 430-440 MHz

El operador debe estar provisto de la licencia correspondiente. Queda prohibida cualquier manipulación de las citadas bandas de frecuencia.



AT	BE	BG	CY	CZ	DE
DK	ES	EE	FI	FR	UK
EL	HR	HU	IE	IT	LT
LU	LV	MT	NL	PL	PT
RO	SK	SI	SE	CH	IS
LI	NO	-	-	-	-