

Title TYT特易通电子有限公司		
Size A	Number TH-9800-A-1.5	Revision
Date:	16-Dec-2013	Sheet of
File:	D:\protel 99SE文件\TH-9800.ddb	Drawn By:

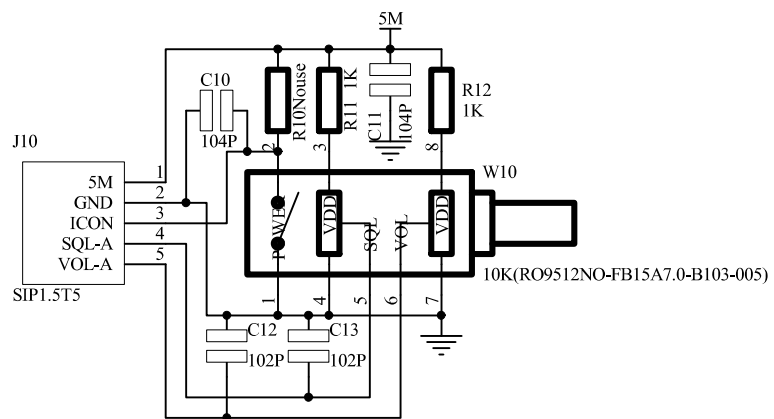

Title		
TYT特易通电子有限公司		
Size	Number	Revision
A	TH-9800-B-1.5	
Date:	16-Dec-2013	Sheet of
File:	D:\protel 99SE文件\TH-9800.ddb	Drawn By:

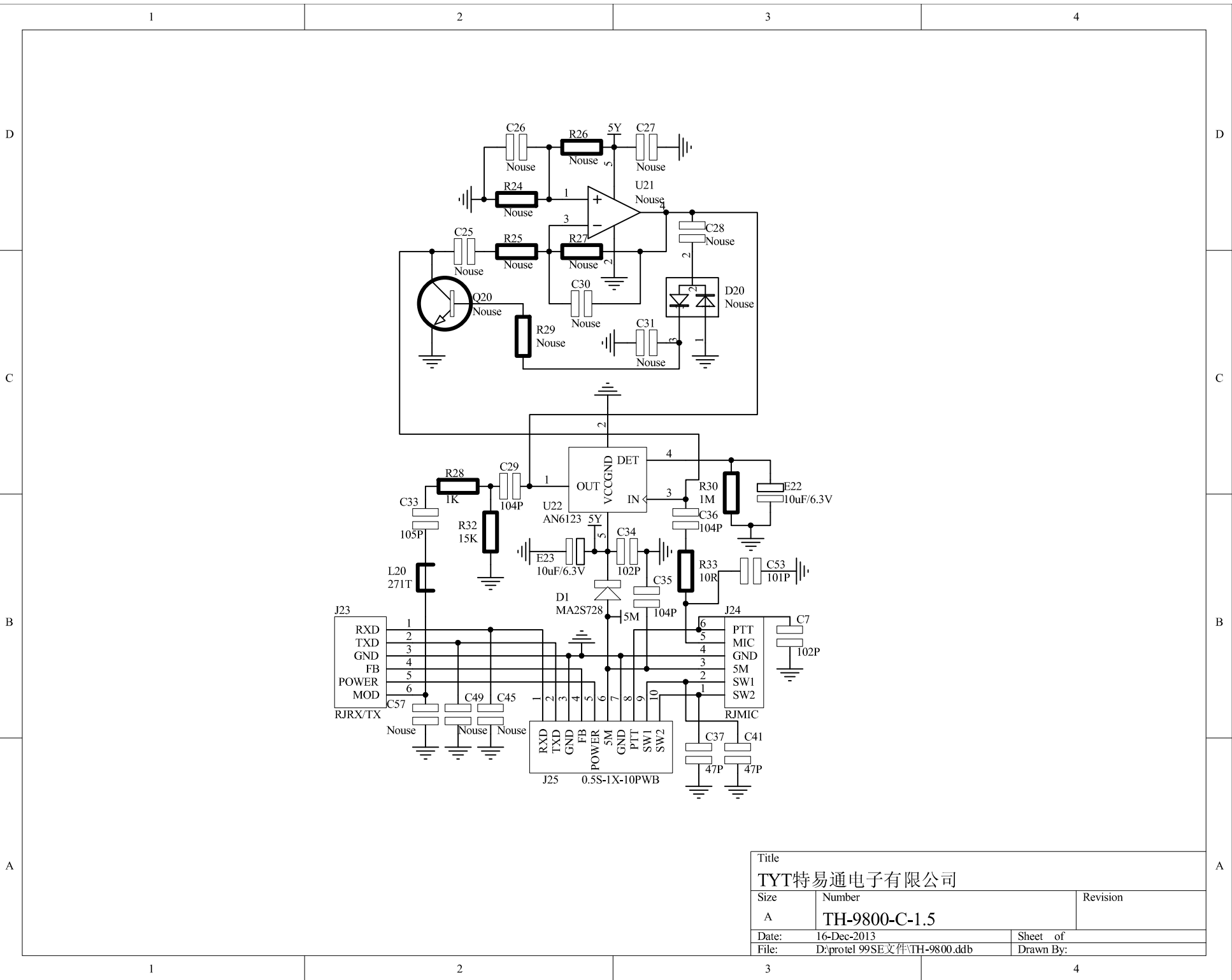

Title		
TYT特易通电子有限公司		
Size	Number	Revision
A	TH-9800-C-1.5	
Date:	16-Dec-2013	Sheet of
File:	D:\protel 99SE文件\TH-9800.ddb	Drawn By:

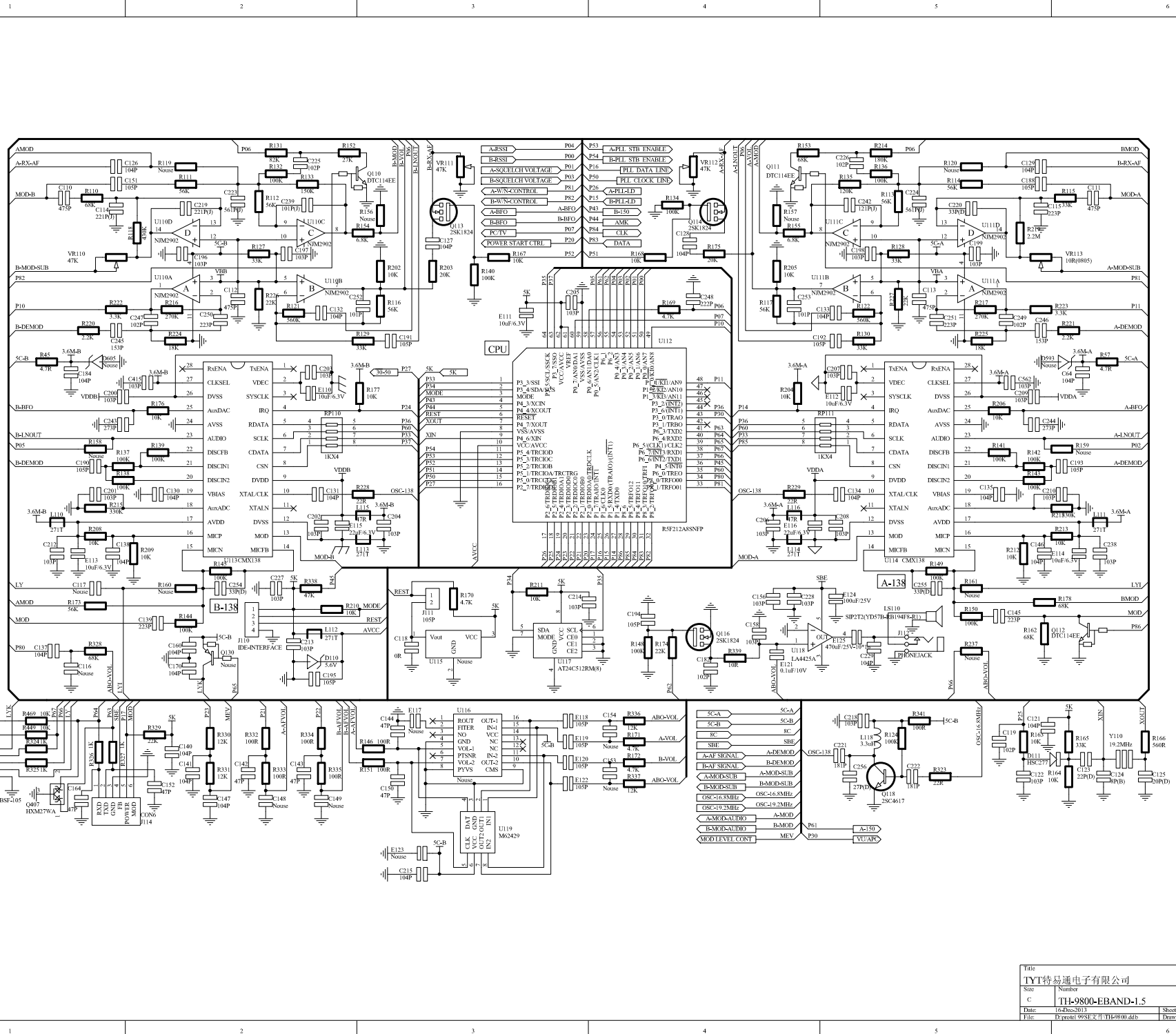

TYT特易通电子有限公司		
Size	Number	Revision
C	TI-9800-EBAND-1.5	
Date:	8/28/2013	Sheet of
File:	PC board 9800-1.5 TI-9800.dbt	Drawn By:

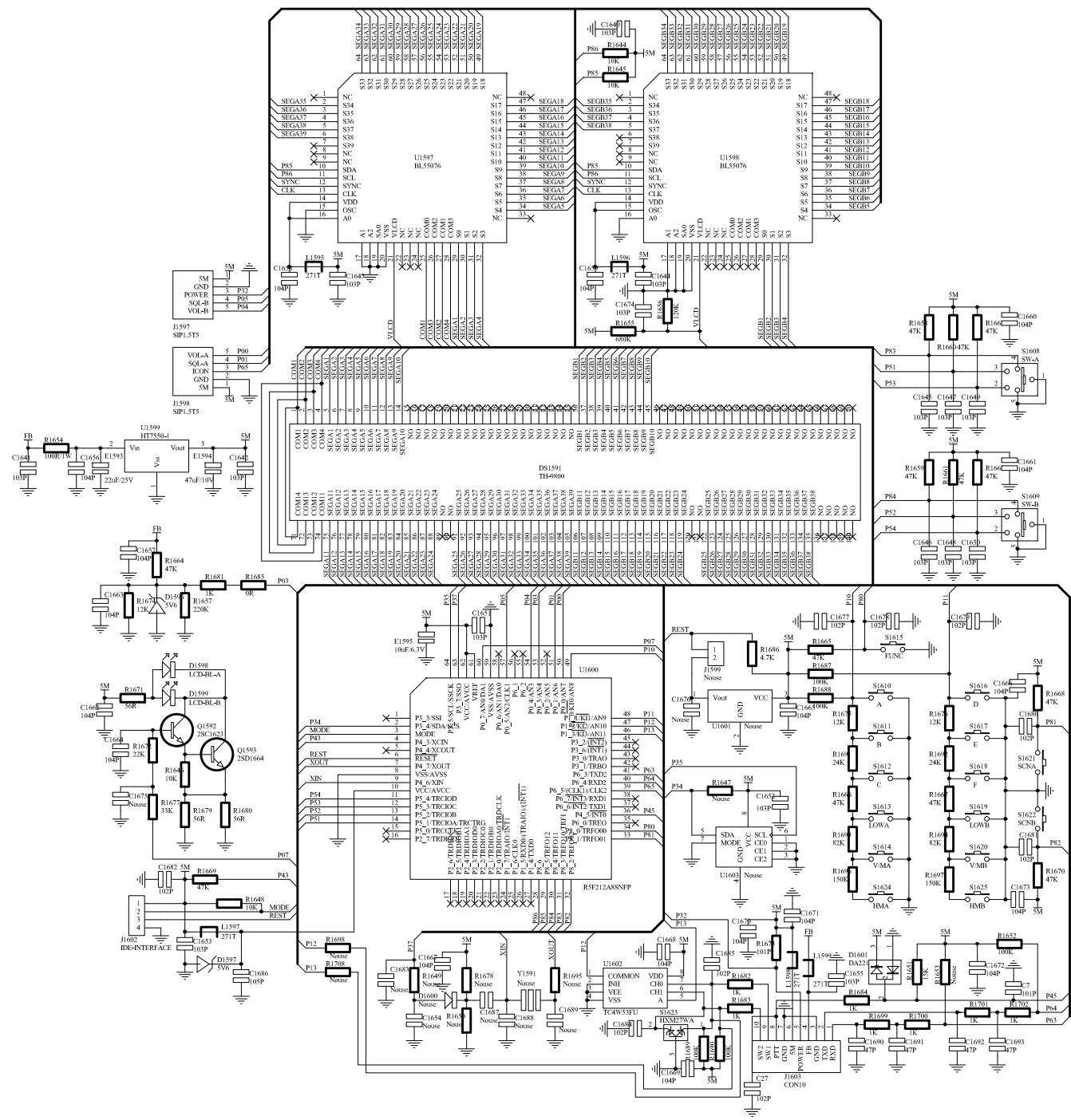

Title			TYT特易通电子有限公司		
Size	Number		Revision		
C	TI1-9800-LCD-1.5				
Date:	2013-03-20	Sheet of			
File:	TY110001-9800-LCD-1.5	Drawn By:			

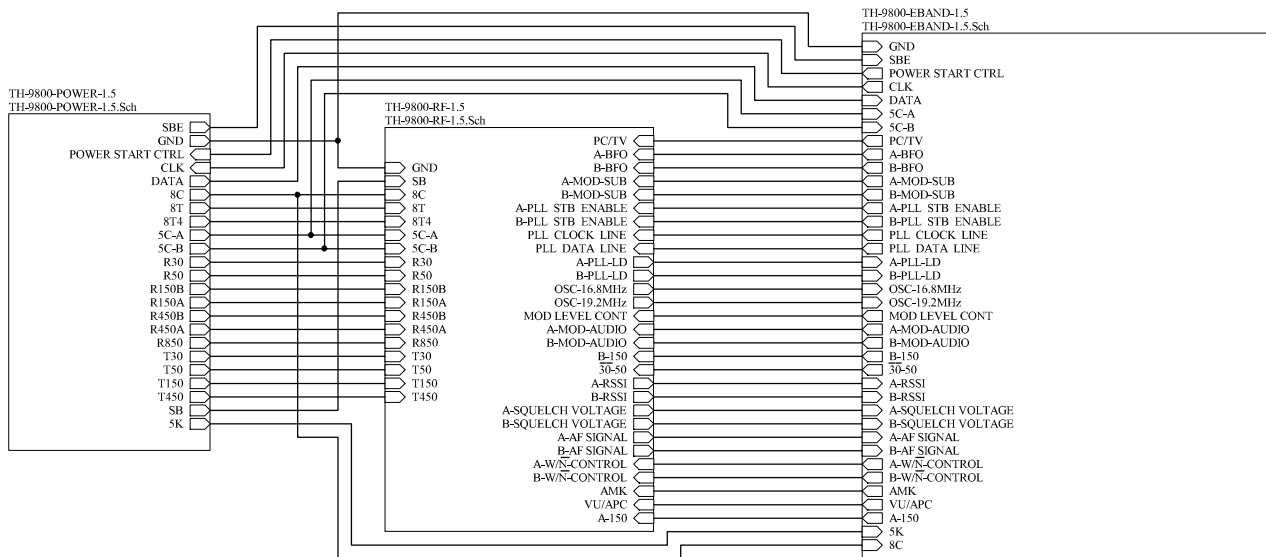

Title		
TYT特易通电子有限公司		
Size	Number	Revision
B	TH-9800-LJ-1.5	
Date:	16-Dec-2013	Sheet of
File:	D:\root\el995E文件\TH-9800.dtb	Drawn By:

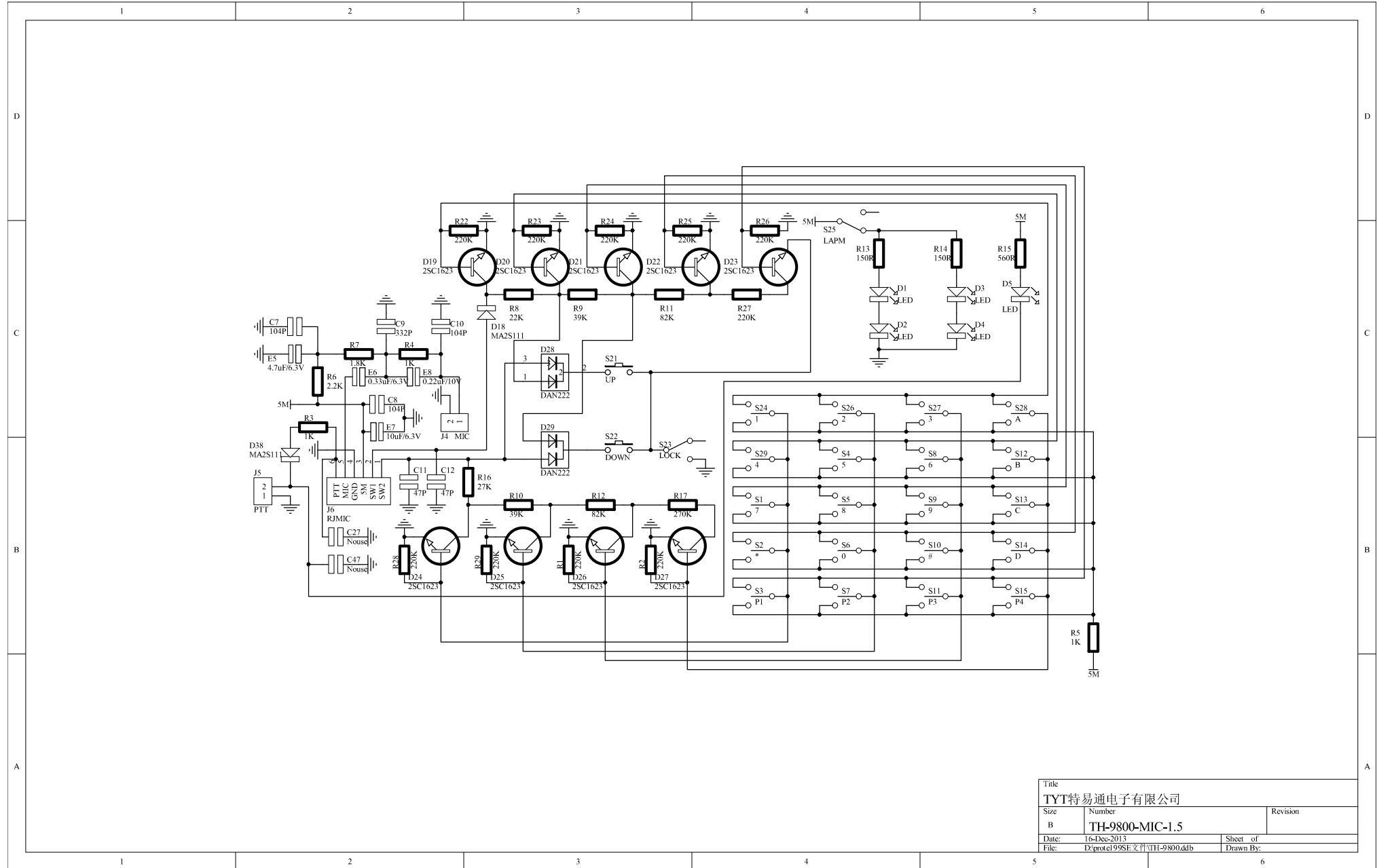

Title		TYT特易通电子有限公司	
Size	Number	Revision	
B	TH-9800-MIC-1.5		
Date:	16-Dec-2013	Sheet of	
File:	D:\root\el995E文件\TH-9800.dtb	Drawn By:	

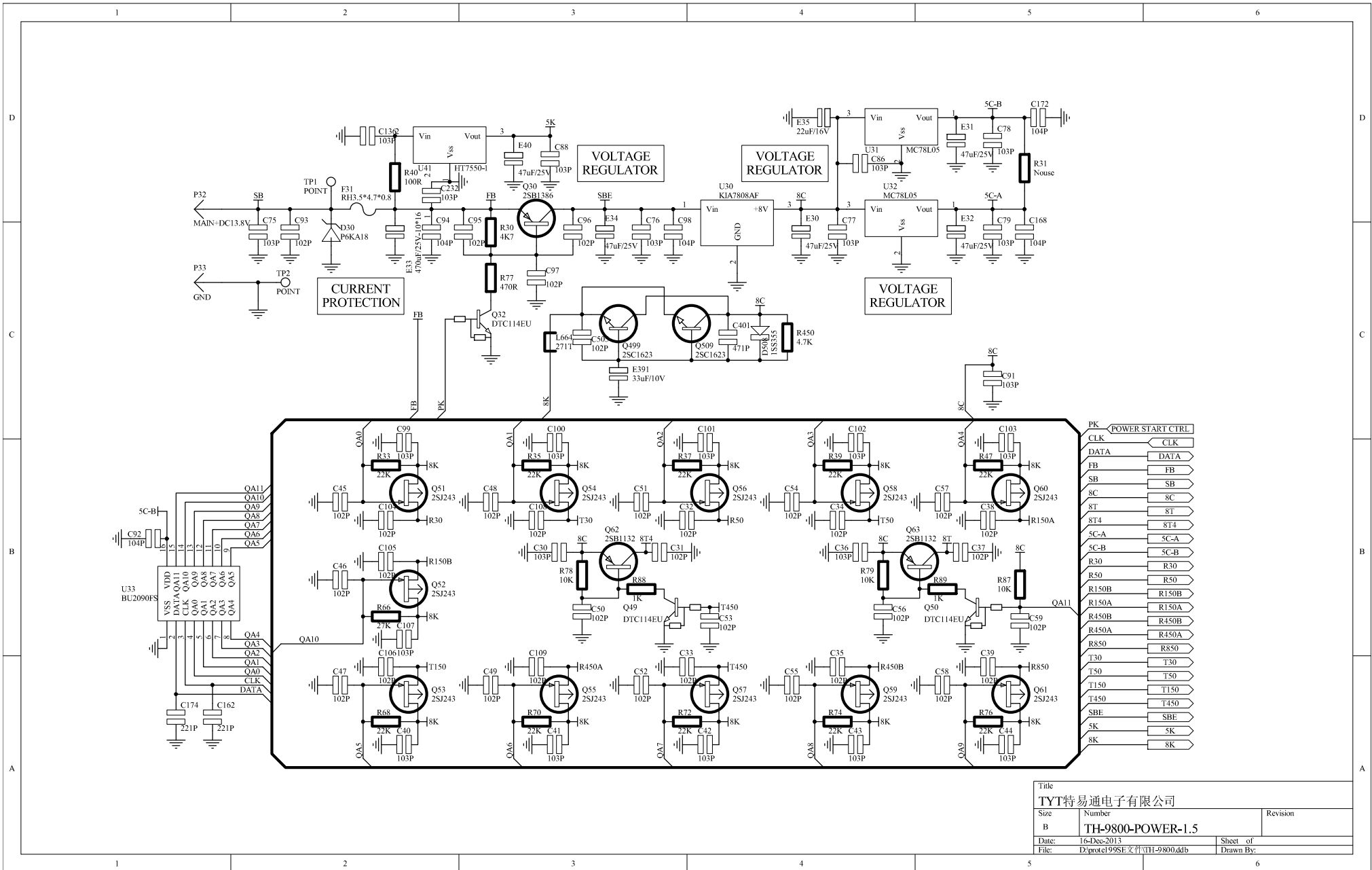

Title	TYT特易通电子有限公司	
Size	Number	Revision
B	TH-9800-POWER-1.5	
Date:	16-Dec-2013	Sheet of
File:	D:\root\99SE文件\TH-9800.dtb	Drawn By:

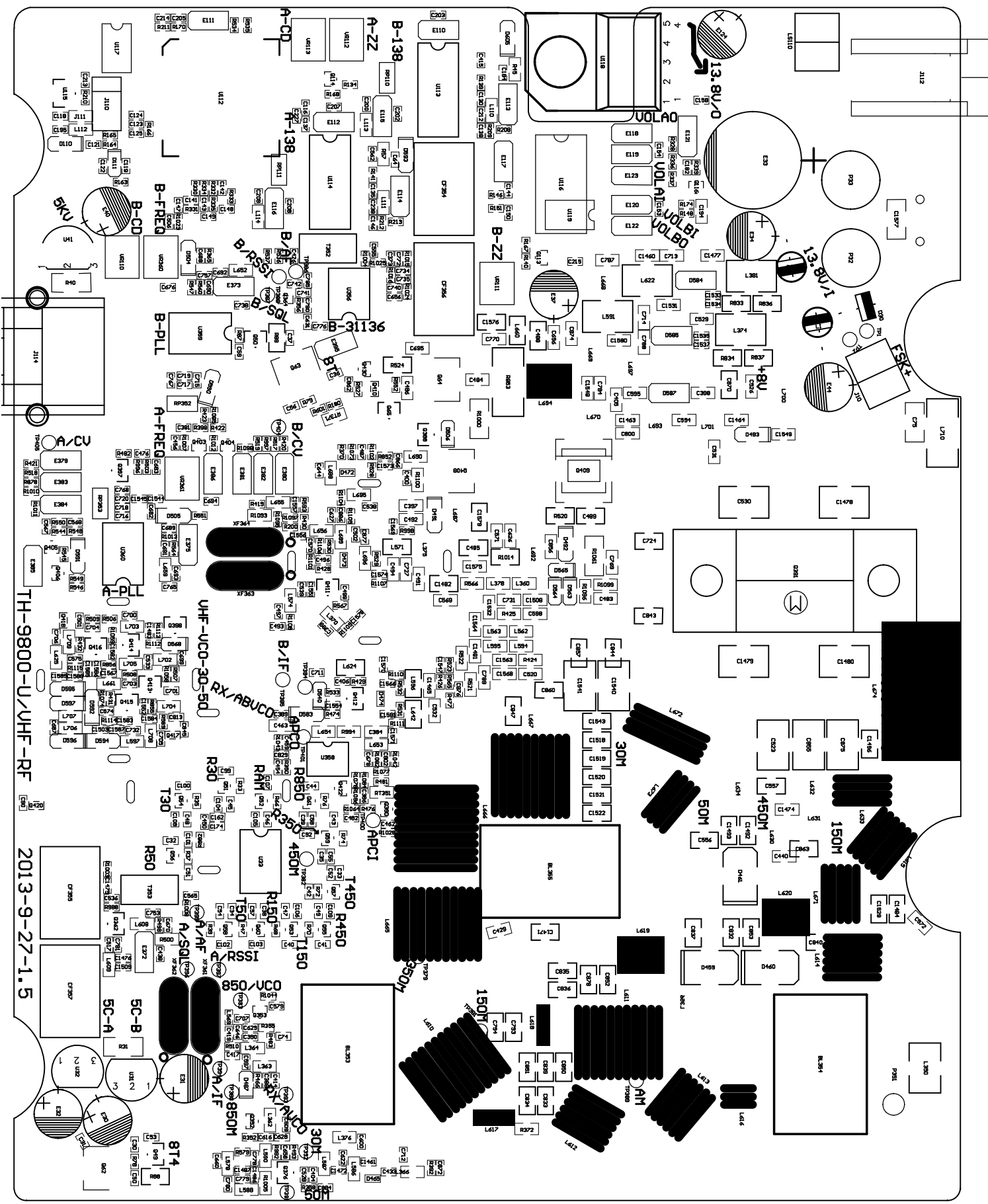

TH-9800-U/VHF-RF

2013-9-27-1.5

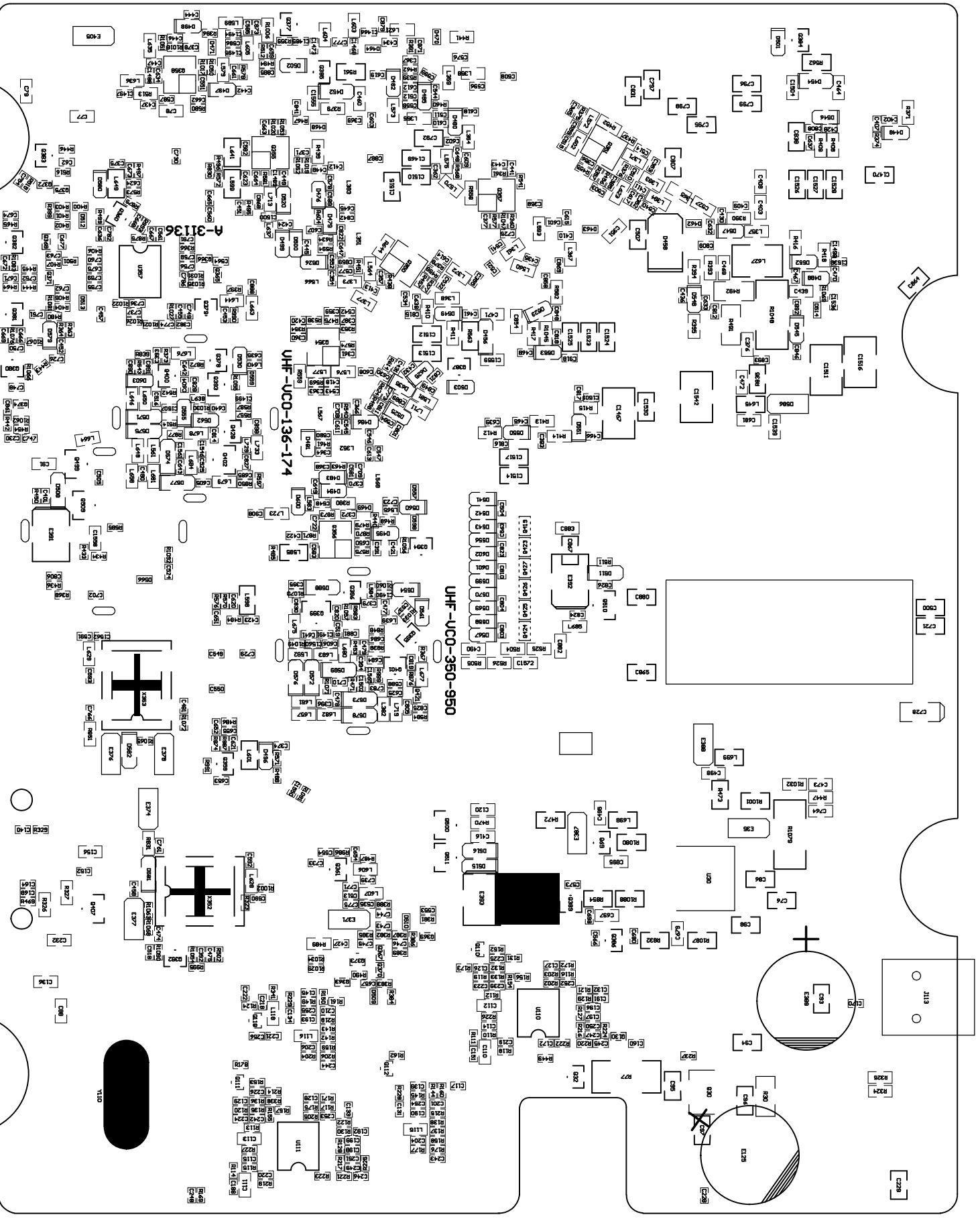

7

7

7

7

7

7

7

7

7

7

7

7

7

7

7

7

7

7

7

7

7

7

7

7

7

7

7

7

7

7

7

7

7

7

7

7

7

7

7

7

7

7

7

7

7

7

7

7

7

7

7

7

7

7

7

7

7

7

7

7

7

7

7

7

7

7

7

7

7

7

7

7

7

7

7

7

7

7

7

7

7

7

7

7

7

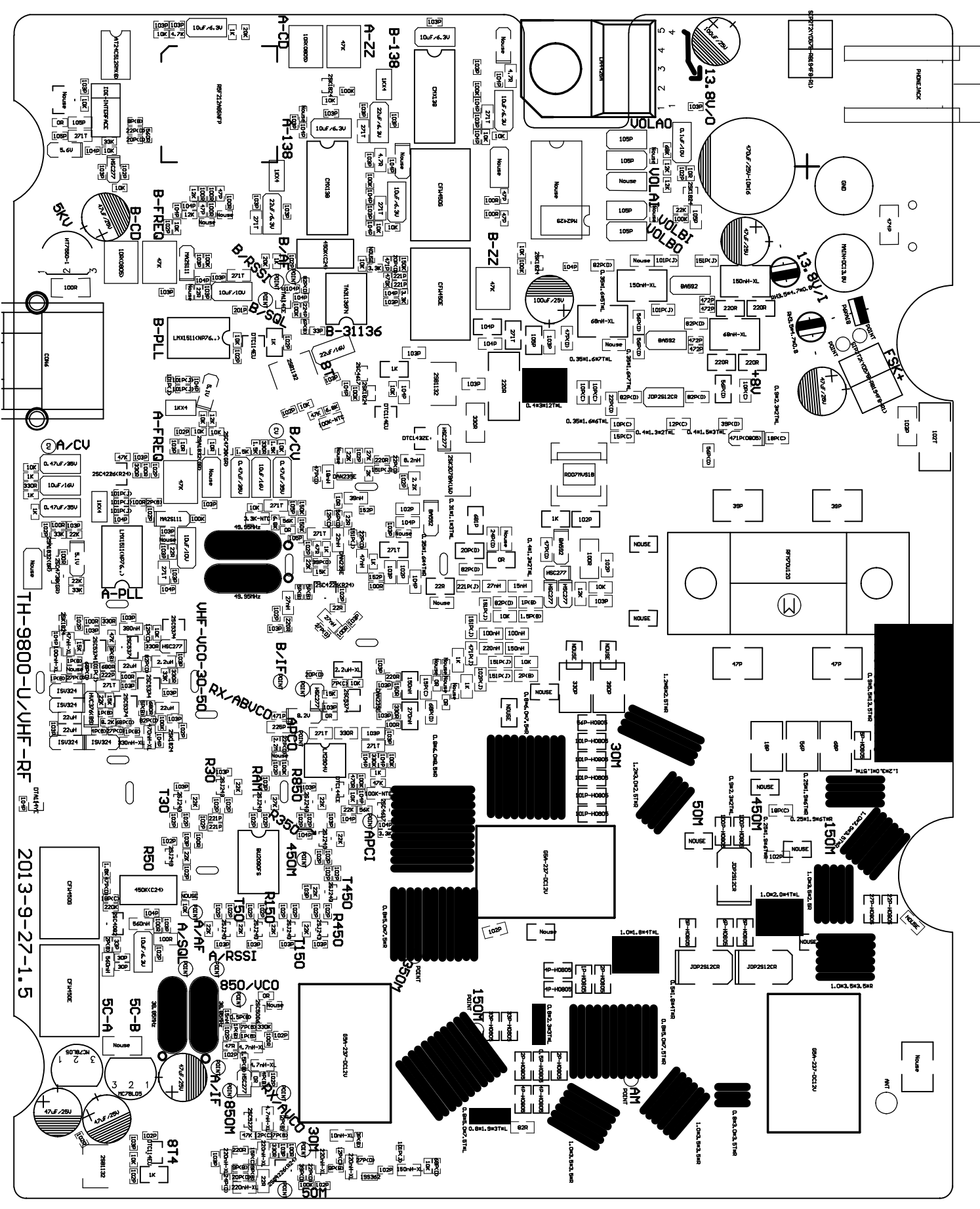

TH-9800-U/VHF-RF

2013-9-27-1.5

814

J1

C3

C4

C1

R1

R2

C2

TH-9800-A
2013-9-27-1.5

R3

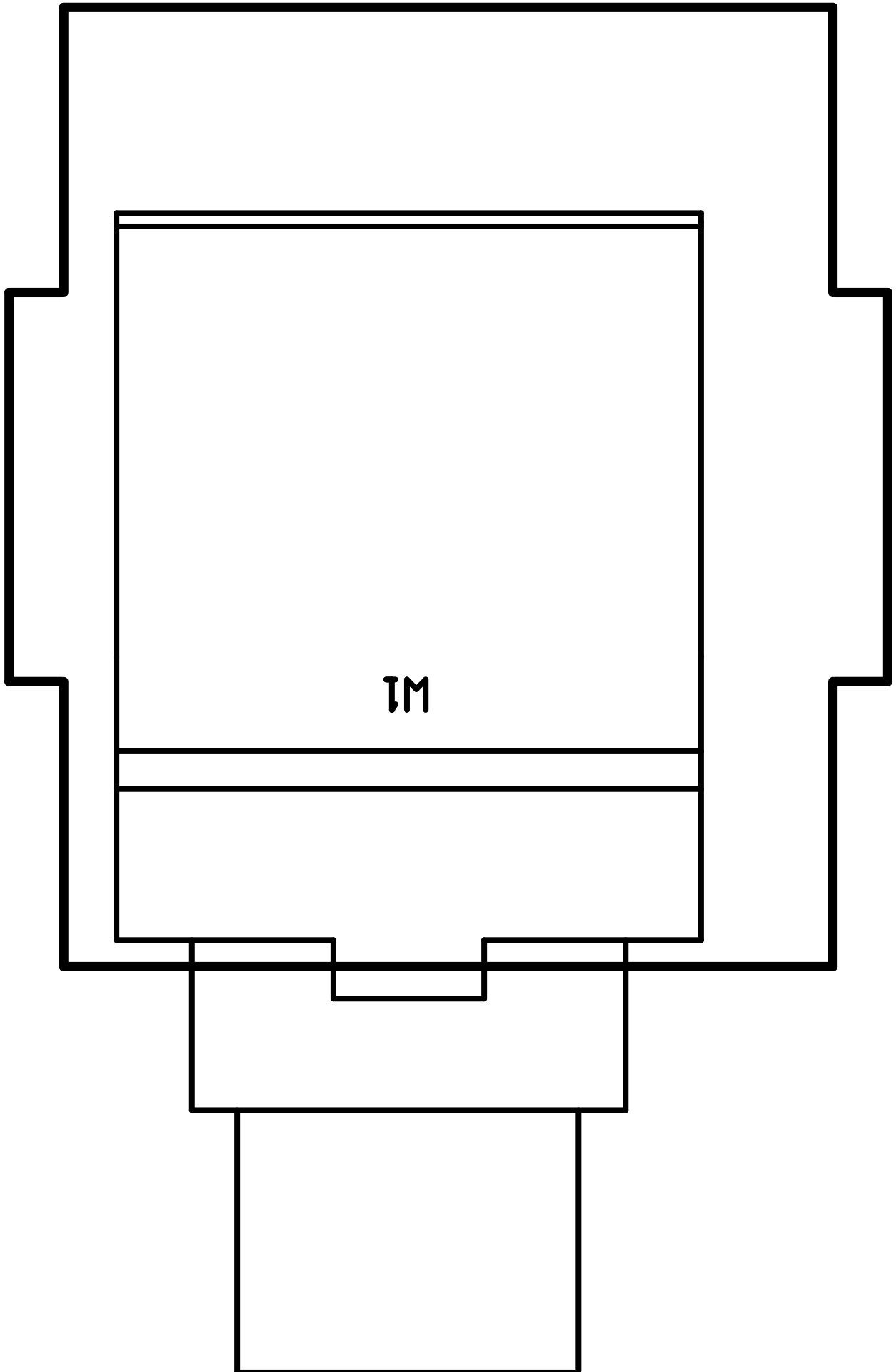

J10

C11

C10

R10

TH-9800-B

R11

C13

C12

2013-9-27-1.5

R12

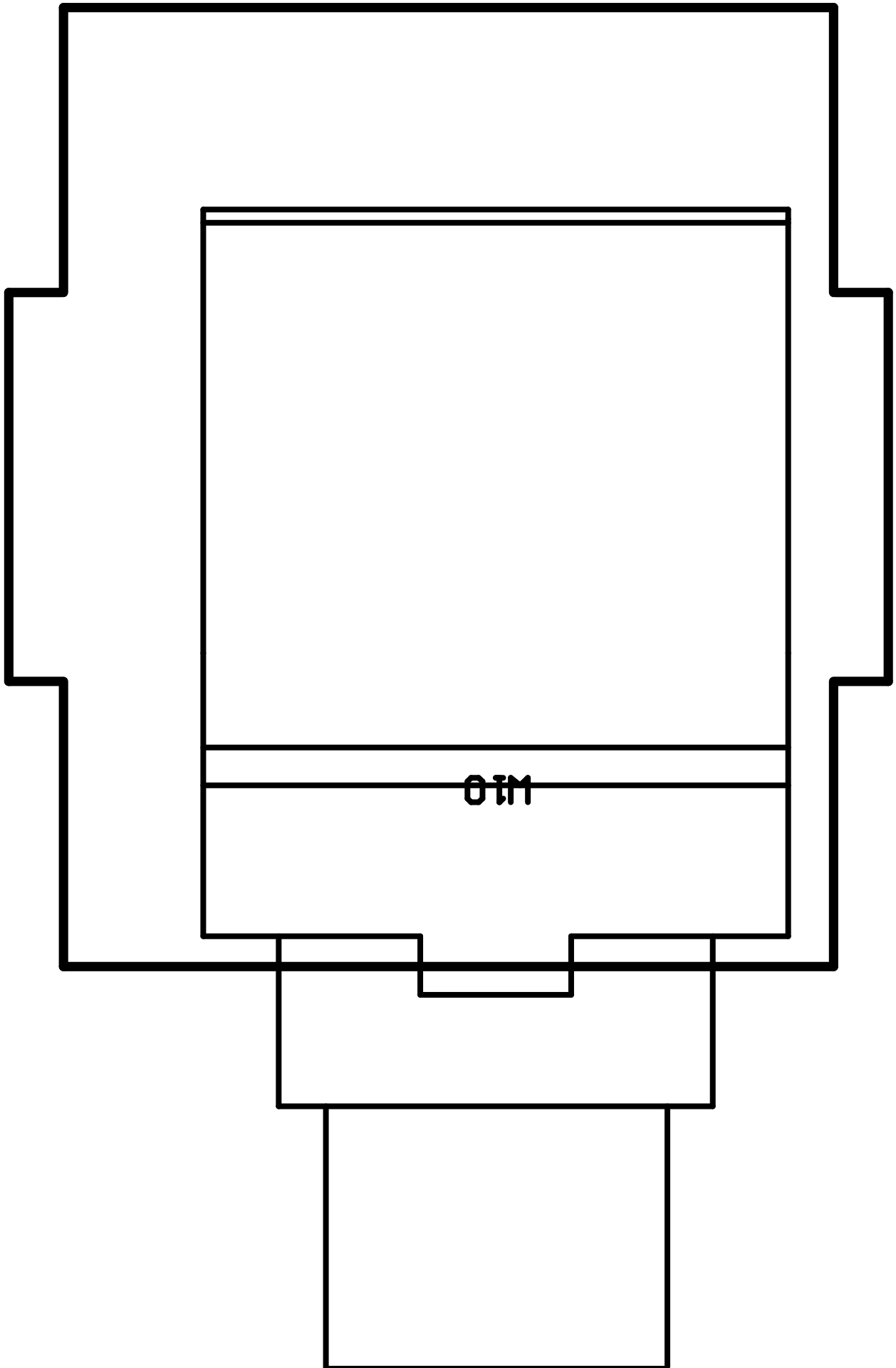

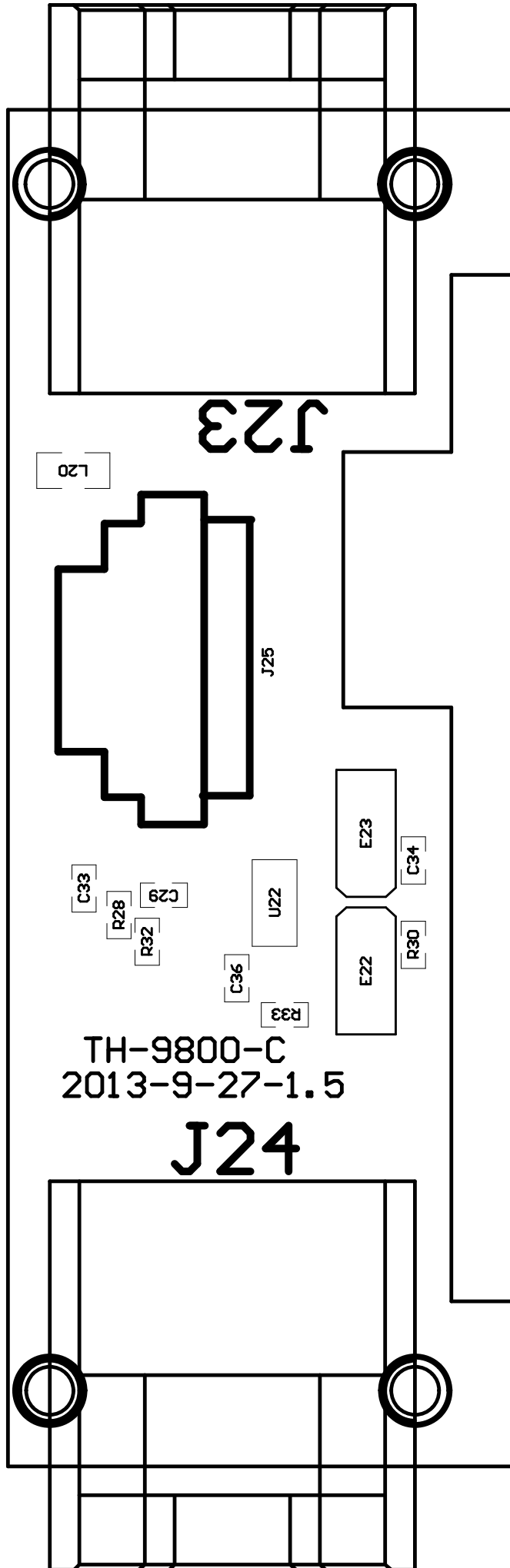

J23

L20

J25

C33

R28

C29

R32

C36

U22

R33

E23

C34

E22

R30

TH-9800-C
2013-9-27-1.5

J24

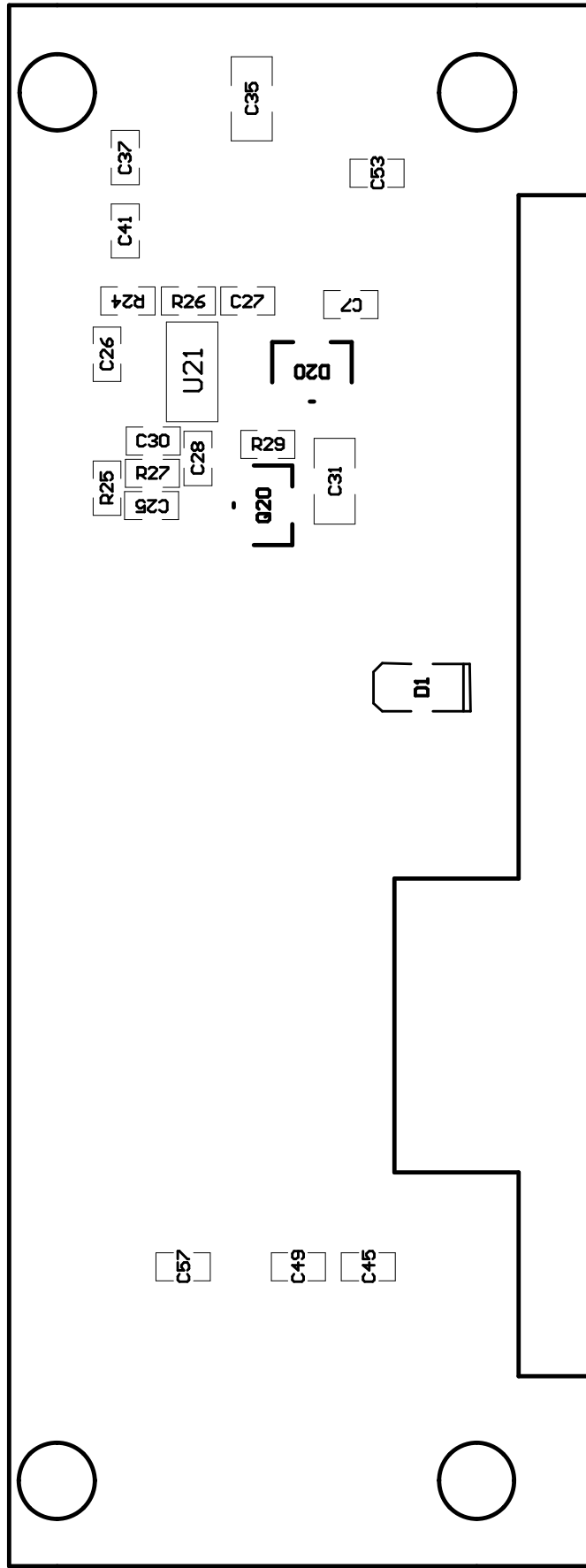

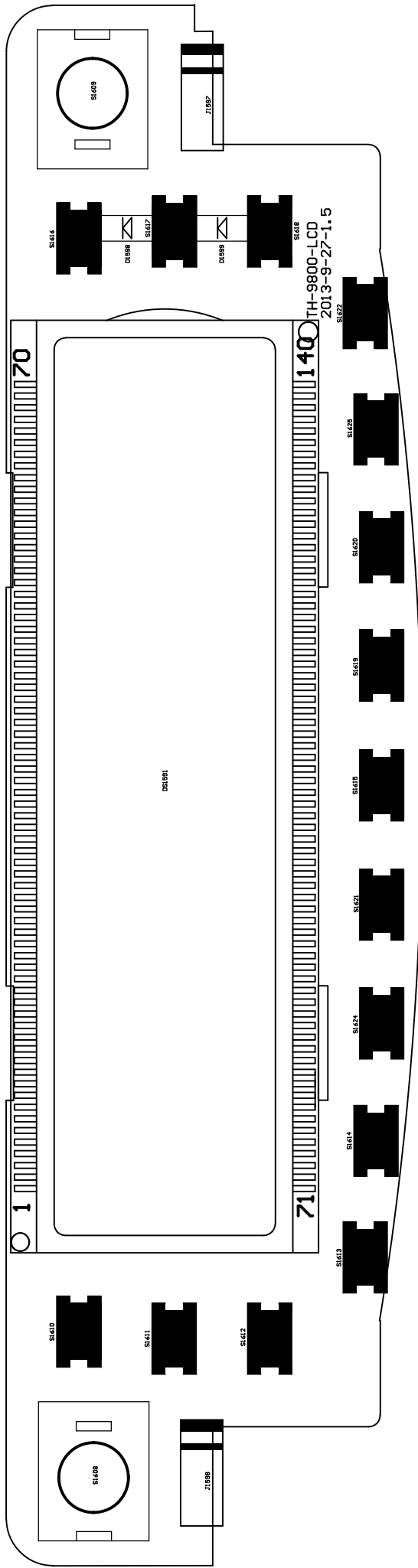

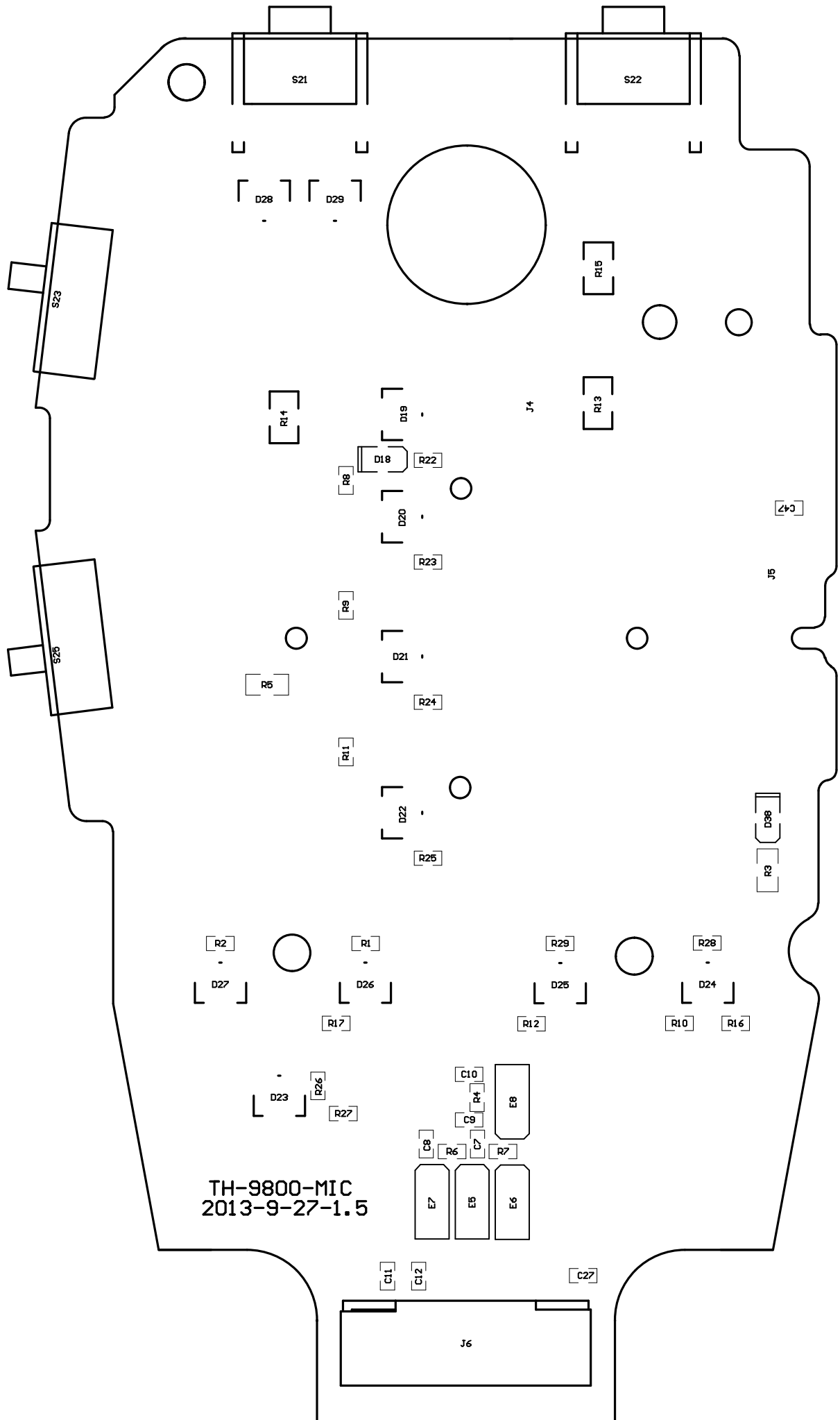

TH-9800-MIC
2013-9-27-1.5

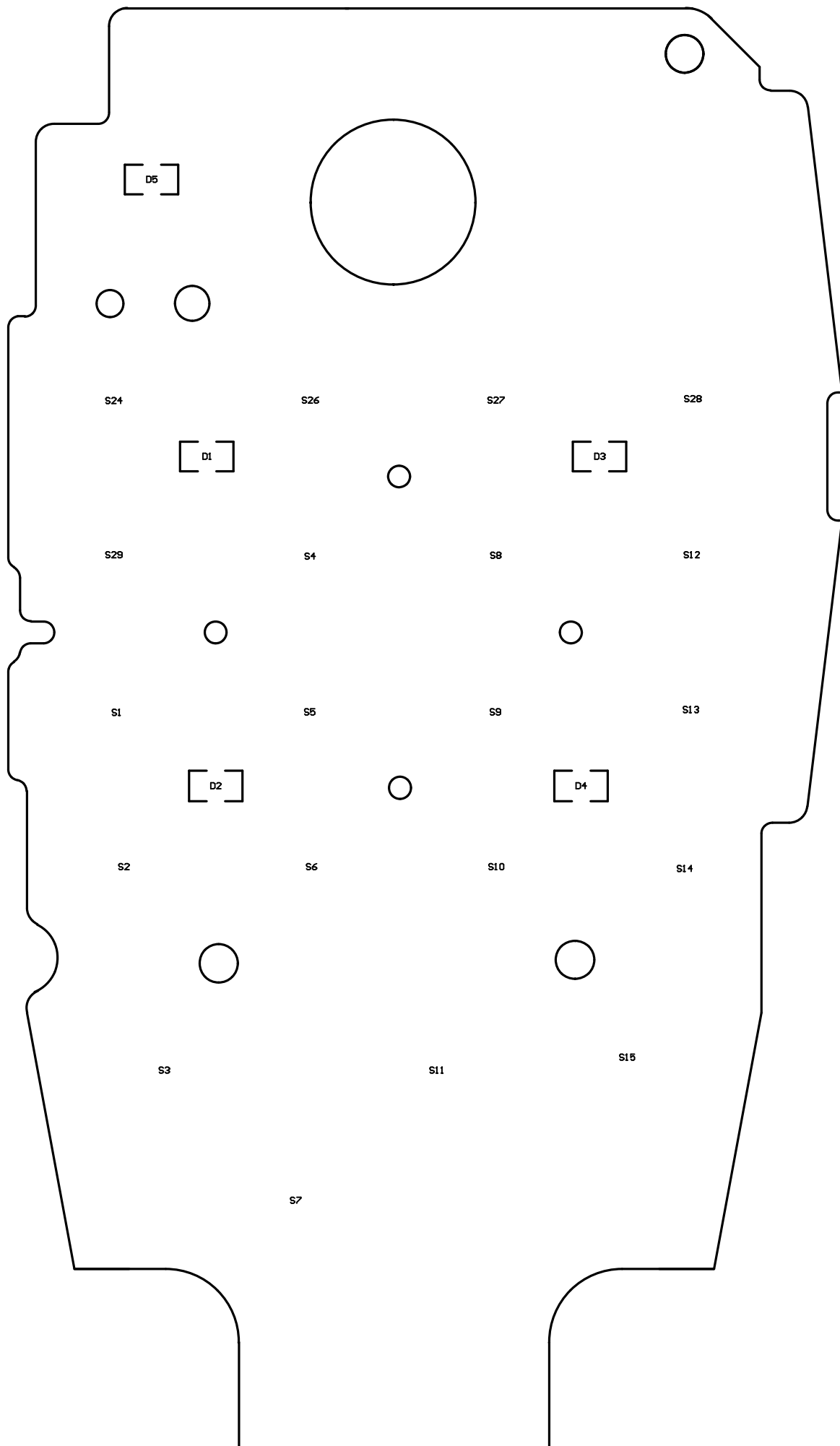

SIP1.5T5

102P 102P 104P

10K

1K

104P TH-9800-A
2013-9-27-1.5

1K

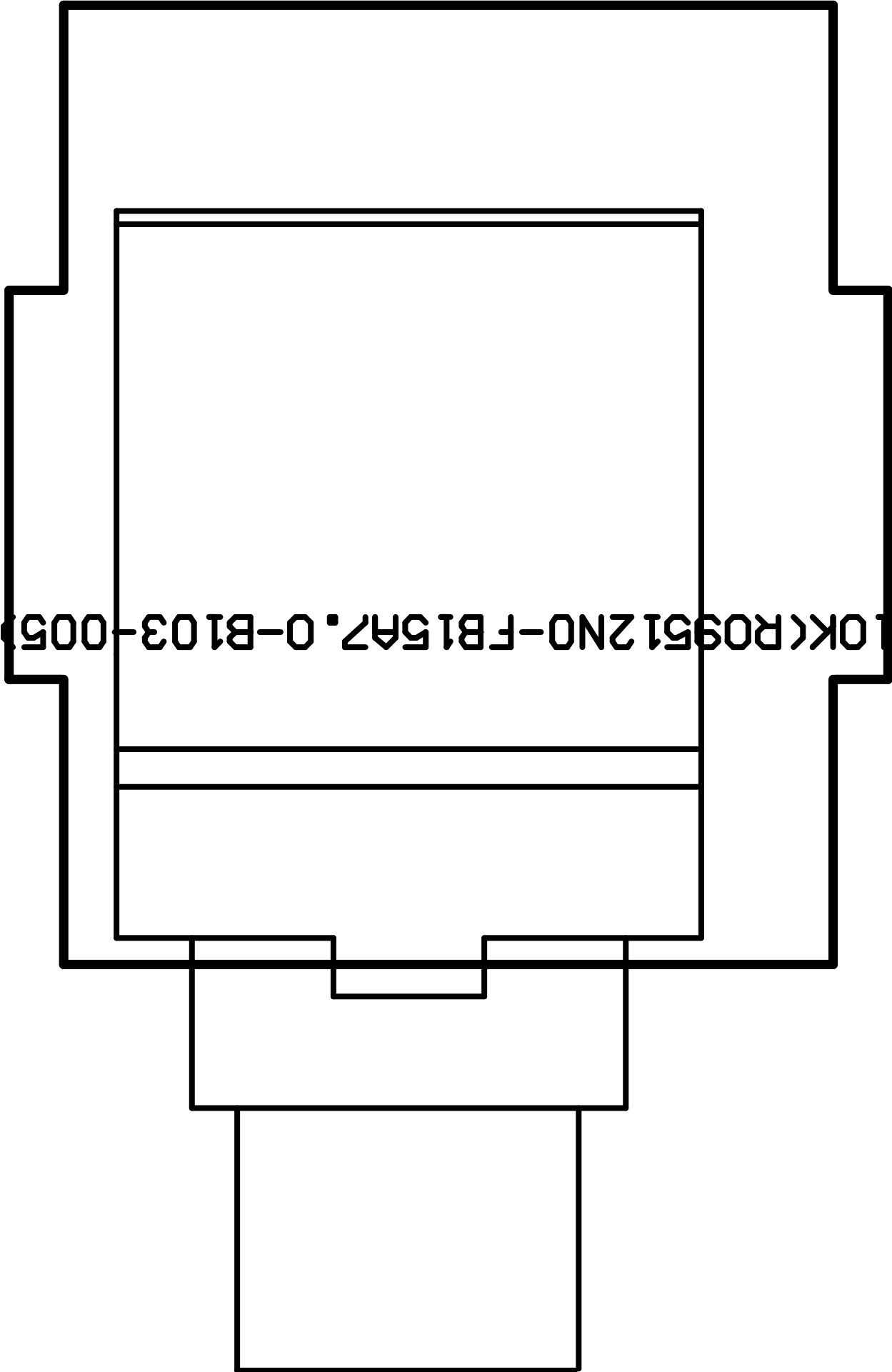

10K(R09512N0-FB15A7.0-B103-005)

SIP1.5T5

104P

104P

Mouse

TH-9800-B

1K

102P

102P

2013-9-27-1¹K.5

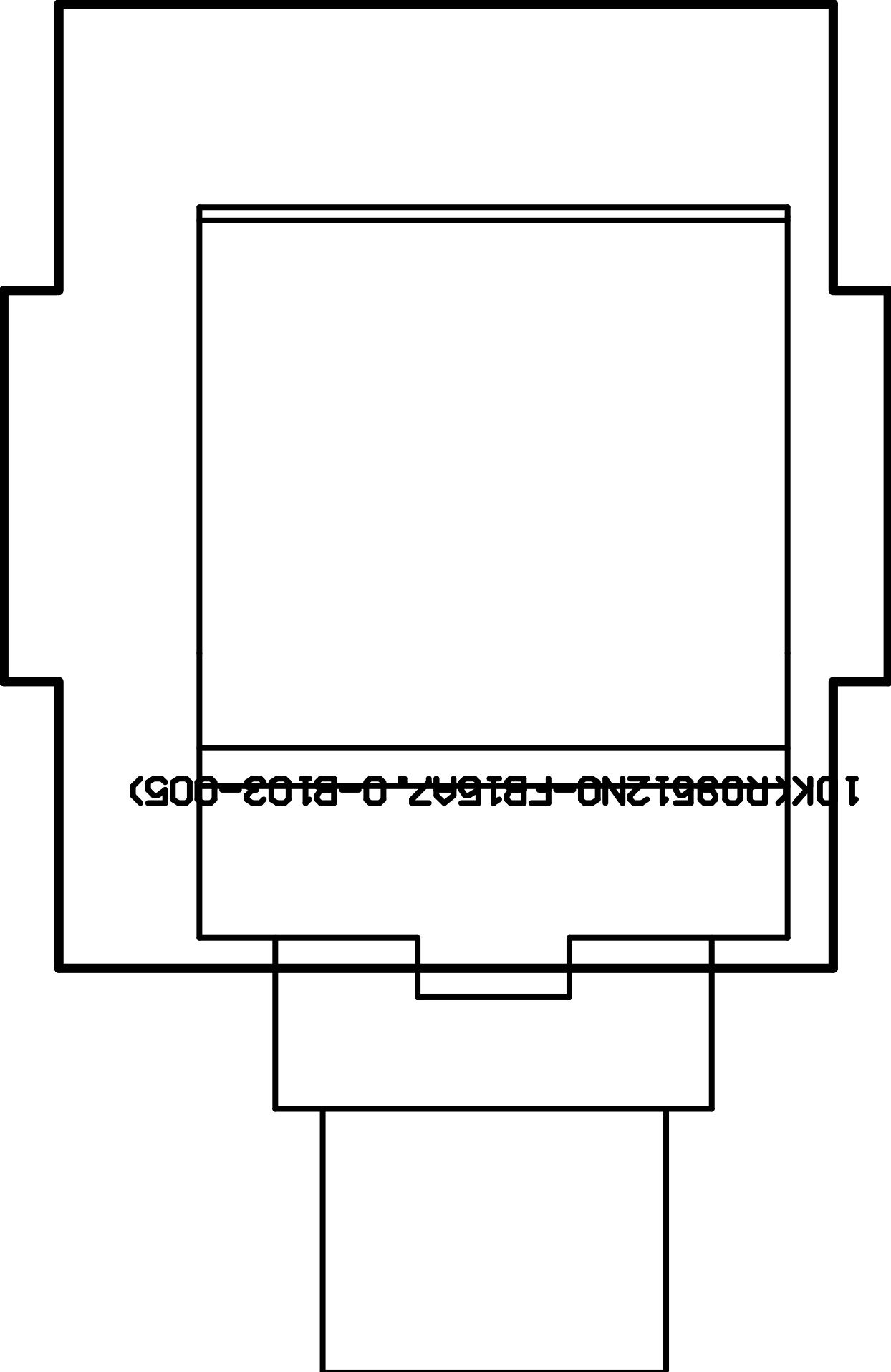

1 DKR09612NO-FB16AZ-0-B103-005)

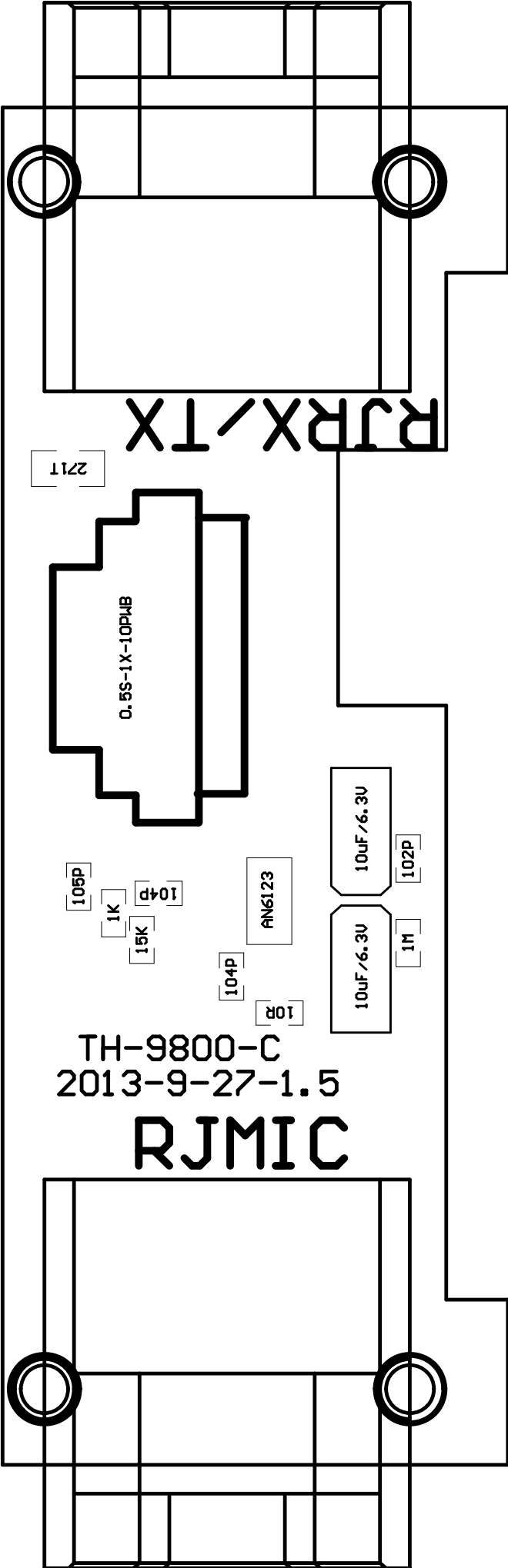

RJR/TX

271T

0.5S-1X-10PMB

106P

1K

104P

15K

104P

ANG123

10R

10uF/6.3V

102P

10uF/6.3V

1M

TH-9800-C
2013-9-27-1.5

RJM IC

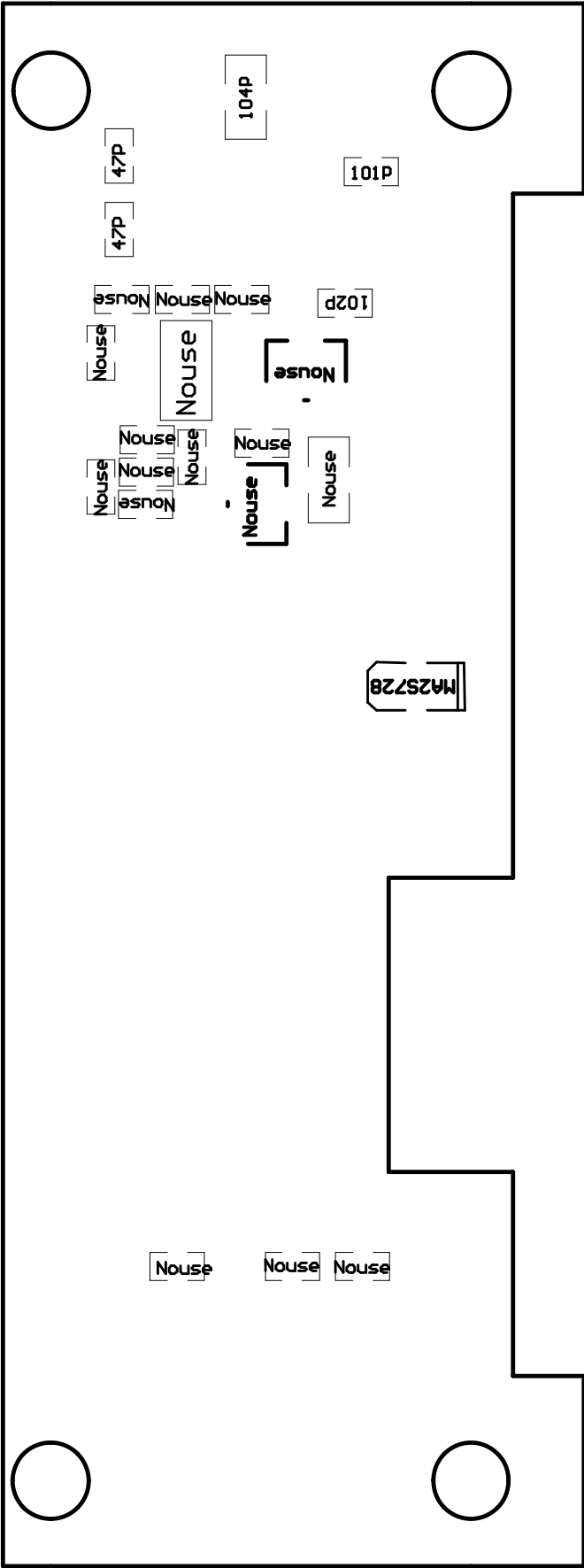

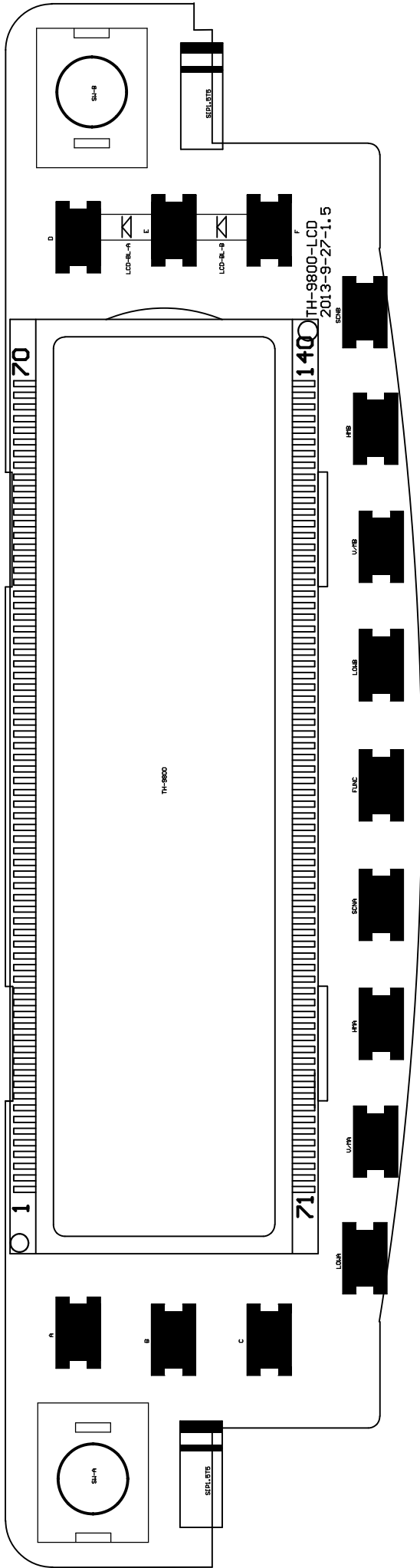

70

1

A

B

C

D

LCD-RL-A

E

LCD-RL-B

F

140

71

TH-9800

TH-9800-LCD
2013-9-27-1.5

SH-A

SH-B

SEPL STB

SEPL STB

LCH

U/PA

MVA

SCVA

FJNC

LONB

U/RS

MVB

SCVB

