



X6100 SDR HF-TRANSCEIVER

1.8 – 28 MHz and 50 MHz

Radioddity Extended manual for Xiegu X6100

V1.0, January 19th 2024

Table of contents

About Radioddity	7
1 Preface	7
2 Revision history of this document	9
3 Product safety and radio frequency exposure	10
3.1 <i>Instructions on using the radio</i>	10
3.2 <i>Electromagnetic interference</i>	11
3.3 <i>Notes on the battery included.....</i>	12
4 Maintenance and care	13
4.1 <i>Maintenance.....</i>	13
4.2 <i>Care</i>	13
5 General information.....	14
6 What is included in the scope of delivery?	15
6.1 <i>Delivery list for the Xiegu X6100.....</i>	15
7 Operating controls and connections of the Xiegu X6100	16
7.1 <i>Controls on the front of the Xiegu X6100.....</i>	16
7.2 <i>Operating controls on the top of the Xiegu X6100</i>	18
7.3 <i>Connections on the left-hand side of the Xiegu X6100</i>	19
7.4 <i>Connections on the right-hand side of the Xiegu X6100.....</i>	20
7.5 <i>Operating controls located on the Xiegu hand-held microphone.....</i>	21
7.6 <i>Electrical connection diagrams for the Xiegu X6100.....</i>	22
7.7 <i>Connecting to an external power supply.....</i>	22
7.8 <i>Charging the battery pack</i>	23
8 Screen display	25
9 Basic operation	27
9.1 <i>Turning the Xiegu X6100 on/off</i>	27
9.2 <i>Setting the volume</i>	27
9.3 <i>Selecting the operating frequency band and operating mode</i>	28
9.4 <i>Setting the operating frequency.....</i>	28
9.5 <i>Setting the RF gain and squelch level</i>	29

9.6	Using VFO-A and VFO-B (A/B / A=B)	30
9.7	Preamplifier/attenuator (PRE / ATT)	30
9.8	Automatic antenna tuner / tuning (ATU / TUNE).....	31
9.9	Using the station memory (V/M / M →V).....	32
9.10	Automatic gain control / split-frequency operation (AGC / SPL).....	33
9.11	Frequency step width / Menu (FST / MENU).....	35
9.12	Transmitting (SSB/AM/FM mode).....	35
9.13	Transmit (CW mode).....	35
9.14	Using the built-in PTT button for sending.....	36
9.15	Operating lock / display backlight.....	37
10	Multifunction menus	38
10.1	The GEN function	38
10.1.1	RADIO SETTING1	39
10.1.1.1	AGC KNEE.....	39
10.1.1.2	AGC SLOPE.....	39
10.1.1.3	AGC HANG.....	40
10.1.1.4	TX POWER.....	40
10.1.1.5	MIC SEL	40
10.1.1.6	I-MIC GAIN	40
10.1.1.7	H-MIC GAIN	40
10.1.1.8	LINE IN LV.....	41
10.1.1.9	LINE OUT LV.....	41
10.1.1.10	MONI LEVEL.....	41
10.1.1.11	PTT MODE.....	41
10.1.1.12	BANDSTACK.....	41
10.1.1.13	S/P MODE.....	42
10.1.1.14	CHARGER.....	42
10.1.2	RADIO SETTING2	42
10.1.2.1	RIT	42
10.1.2.2	XIT	42
10.1.2.3	SPLE	43
10.1.2.4	HANDLE F1.....	43
10.1.2.5	HANDLE F2.....	44
10.1.3	DISPLAY SETTING	44
10.1.3.1	RF FFT AVE	44
10.1.3.2	RF FFT REF	44
10.1.3.3	FFT SPAN	44
10.1.3.4	FFT PK HOLD	45
10.1.3.5	WF REF.....	45
10.1.3.6	AF FFT AVE.....	45
10.1.3.7	AF FFT REF.....	45
10.1.3.8	BL LEVEL.....	45

10.1.4	SYSTEM SETTING	46
10.1.4.1	TIME SETTING	46
10.1.4.2	SYSTEM INFO	48
10.1.4.3	FIRMWARE UPGRADE	49
10.1.4.4	WLAN	50
10.1.4.5	BLUETOOTH	52
10.1.4.6	WFSERVER	53
10.1.4.7	FACTORY RESET	54
10.1.5	MEMORY EDIT	55
10.1.5.1	TAG	56
10.1.5.2	MARK	57
10.1.5.3	ERASE MEMO	57
10.1.5.4	SAVE VFO	58
10.1.5.5	EXIT	58
10.2	<i>The APP function</i>	59
10.2.1	MODEM	59
10.2.1.1	<1>/<2>	59
10.2.1.2	MODE	59
10.2.1.3	FC/TONE	60
10.2.1.4	RATE/SPEED	60
10.2.1.5	RTTY SHIFT	60
10.2.1.6	AFC	61
10.2.1.7	SQL	61
10.2.1.8	CLEAR	61
10.2.1.9	Sending prepared text messages	61
10.2.1.10	EXIT	62
10.2.2	SWR SCAN	62
10.2.2.1	SPAN	62
10.2.2.2	SPEED	62
10.2.2.3	EXIT	62
10.2.3	VOICE CALL	63
10.2.3.1	VOICE MSG 1...5	63
10.3	<i>The KEY function</i>	63
10.3.1	KEY TYPE	63
10.3.2	KEY SPEED	64
10.3.3	IAMBIC	64
10.3.4	TONE	64
10.3.5	TONE LEVEL	64
10.3.6	QSK TIME	64
10.3.7	DI/DA RATIO	65
10.3.8	CW TRAINER	65
10.4	<i>The MSG function</i>	65
10.4.1	MSG 1...5 (Text)	66
10.4.2	MSG 1...5 (Voice)	67
10.5	<i>The DFN function</i>	68

10.5.1	NR.....	69
10.5.2	NR DEPTH	69
10.5.3	NB.....	69
10.5.4	NB WIDTH	69
10.5.5	NB LEVEL.....	70
10.5.6	DNF.....	70
10.5.7	DNF CENTER	70
10.5.8	DNF WIDTH.....	70
10.6	<i>The DFL function</i>	<i>71</i>
10.6.1	FILTER1...3.....	72
10.6.2	DEFAULT	72
10.6.3	CLOSE.....	72
11	Updating the Xiegu X6100 firmware	73
11.1	<i>Preparing the microSD/flash memory card</i>	<i>73</i>
11.1.1	<i>Writing the Xiegu X6100 firmware to the microSD/flash card</i>	<i>73</i>
11.2	<i>Updating the Xiegu X6100 operating system (APP)</i>	<i>77</i>
11.3	<i>Updating the baseband firmware of the Xiegu X6100 (BASE).....</i>	<i>78</i>
12	Firmware release notes	82
12.1	<i>Firmware as of August 31st 2023</i>	<i>82</i>
13	Use of wfview	83
13.1	<i>Preparation</i>	<i>83</i>
13.2	<i>Required connectivity settings.....</i>	<i>83</i>
13.2.1	Installing WFVIEW.....	83
13.2.1.1	Download von WFVIEW	83
13.2.1.2	Unpacking the WFVIEW download archive	84
13.2.1.3	Installation von WFVIEW	84
13.3	<i>Preparing Xiegu X6100 for Wi-Fi access.....</i>	<i>88</i>
13.4	<i>Starting WFSERVER on Xiegu X6100.....</i>	<i>88</i>
13.5	<i>Starting WFVIEW on the computer.....</i>	<i>90</i>
14	Connecting accessories.....	94
14.1	<i>Accessories for the Xiegu X6100.....</i>	<i>94</i>
14.2	<i>Connecting the Xiegu hand-held microphone.....</i>	<i>100</i>
14.3	<i>Connecting a Morse key.....</i>	<i>100</i>
14.4	<i>Connecting the Xiegu XPA125B HF amplifier</i>	<i>100</i>
14.4.1	<i>Tuning the Xiegu XPA125B antenna tuner.....</i>	<i>102</i>
14.5	<i>Connecting the Xiegu X6100 to a computer (DEV).....</i>	<i>105</i>
14.6	<i>Connecting USB accessories to the Xiegu X6100 (HOST).....</i>	<i>106</i>

15	CI-V.....	106
16	Digital modes and CAT-control	113
16.1	<i>Software for digital modes</i>	<i>113</i>
16.1.1	FT8.....	113
16.1.2	JS8.....	113
16.1.3	WSJT.....	114
16.1.4	WSJT-X	114
16.1.5	FLdigi	118
16.1.6	Dimension 4	119
16.1.7	GridTracker.....	120
16.2	<i>Software for CAT control.....</i>	<i>120</i>
16.2.1	Flrig.....	120
17	Technical data	123
18	Certifications.....	125
18.1	<i>CE certificate for Xiegu X6100.....</i>	<i>125</i>
18.2	<i>FCC part 90 approval for Xiegu X6100.....</i>	<i>126</i>
19	Common issues and their solution.....	127
20	Where to find further information?.....	131
20.1	<i>Radioddity support area.....</i>	<i>131</i>
20.2	<i>Xiegu-X6100 group on groups.io.....</i>	<i>131</i>

About Radioddity

“You, our friend and customer, are our focus”

At Radioddity, our customers are important to us. As a customer, your time and money are important to you. When you buy radios online, you face a dilemma: buy from a reputable website at a high price, or try to save money by choosing a retailer that may not offer quality goods, service or advice. At Radioddity.com, you don't have to choose between low prices and a safe shopping experience. Whether you are a first-time shopper or an experienced radio amateur, we always do our utmost to ensure that you get the best possible value for money. Over the past few years, Radioddity has continuously strived to better meet the needs of wireless equipment buyers and has become a reliable partner. We do this by offering the highest quality products at an affordable price and by providing you with first-class support after purchase as well as out of warranty. Because as our customer, you deserve nothing less.

Our promise: To offer you the best shopping experience

Strong partnerships enable us to offer you the latest technologies with an excellent price/performance ratio under the Radioddity brand name. Our experienced and responsive customer service team helps us to deliver on our promise to you and better meet your everyday needs. Whether it's offering you the latest and greatest DMR, HF and analog radios, accessories and related products, providing outstanding technical support or working with amateur radio industry leaders to develop helpful content to assist you with your purchase: Your concern is our concern. We want to provide you with quality radios at great prices. If you feel we are not delivering on this promise in any way, please let us know by e-mail:

support@radioddity.com

Copyright© 2024 by Radioddity

All rights reserved. This manual or any part of it may not be reproduced or used in any way without written permission from the publisher, except for brief quotations in critical reviews and for certain other non-commercial uses permitted by copyright law. For permission requests, please contact the publisher.

1 Preface

This extended manual goes far beyond the contents of the manual you received when you purchased your Xiegu X6100. Firmware updates can change the functions of the Xiegu X6100. New functions may also be added or existing

functions may be completely removed. For this reason, we endeavor to keep this extended manual up to date at all times.

Our support is only available via support@radioddity.com. If you find something in this document that should be corrected or added, please let us know via the same e-mail address.

Windows™, Linux™ and OS X™ are trademarks of their respective owners. If a trademark assignment is missing, incorrect or erroneous, please contact us as soon as possible so that we can correct this immediately

Parameter names as displayed on the screen of the Xiegu X6100 are written in **bold italics**.

The 5 buttons immediately below the LCD, labeled only with a '---', are referred to as **softkeys**. Whenever certain functions are assigned to them, these are displayed at the bottom edge of the LCD, directly above the corresponding button.

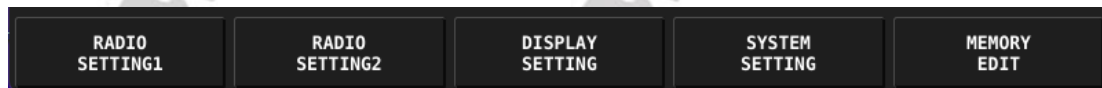

2 Revision history of this document

We are constantly striving to update our manuals in line with changes resulting from new firmware versions. If you miss an aspect in this document or believe that something has been described incorrectly or misleadingly, please give us feedback via our central e-mail address support@radioddity.com. We will do our best to make the next version of this document even better for you.

revision	changes	released
V1.0	<ul style="list-style-type: none">First version, based on the original English manual, but extensively supplemented, currently suitable for APP V1.1.7 as of August 25th 2023, 15:09:46 and BASE V1.1.6 as of March 7th 2023, 09:57:03.	2024/01/19

3 Product safety and radio frequency exposure

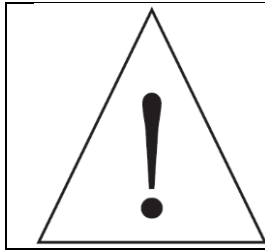

Before using the Xiegu X6100, please read this extended manual carefully. It contains important instructions for the safe and proper use of the radio as well as operating instructions for compliance with the limits for radio frequency exposure in accordance with the applicable national and international standards.

3.1 Instructions on using the radio

Please read the following quick guide as failure to follow these rules can be dangerous or against the law.

1. Observe local and national regulations before using this radio, as improper use may violate applicable laws.
2. Do not charge or replace the battery contained in the radio in a flammable or explosive atmosphere.
3. Do not use a radio with a damaged antenna, as touching the damaged antenna may result in injury.
4. Do not attempt to dismantle the radio; all servicing should be carried out by qualified technicians. Opening the device will also invalidate any warranty claims.
5. Do not place the radio in the airbag deployment area of vehicles equipped with airbags.
6. Stay at least a few meters away from the antenna system connected to the radio.
7. Ensure that the antenna system is adequately earthed and has appropriate lightning protection.
8. Do not transmit for long periods of time as this may damage the radio or cause it to become hot enough to cause injury.
9. Do not use the device during thunderstorms. Disconnect the device from the power supply and the antenna beforehand.
10. Do not connect an AC power supply to the DC interface on the left side of the transceiver. Doing so may cause interference or damage to the device.
11. Do not apply a voltage of more than 15 V DC to the DC interface on the left side of the transceiver. Doing so may cause interference or damage to the device.
12. Do not reverse the polarity of the power supply cable. Doing so may cause interference or damage to the device.
13. Do not operate or touch the appliance with wet hands. Doing so may result in electric shock or damage to the appliance.
14. If you notice smoke or a strange odor, immediately disconnect the power supply, unplug the power supply cable and contact the supplier.
15. If the radio emits smoke or a burning smell, switch it off immediately, disconnect it from the power supply and contact your dealer.

16. Do not use the device in areas, vehicles or airplanes where this is prohibited. Do not use the device while driving or operating technical equipment.
17. Do not use the device at filling stations or in places where flammable gases are present or in the vicinity of potentially explosive atmospheres.
18. To avoid electromagnetic interference, turn off the radio in places where signs with similar instructions such as 'Do not use wireless devices' or 'Turn off cell phones' are posted, such as in hospitals and healthcare facilities or in an environment where people carry medical equipment.
19. Do not expose the device to rain, snow or other liquids. Otherwise, the device may be damaged.
20. When using headphones, make sure that the volume is not set too high.
21. Do not disassemble or modify the device.
22. Do not place the device near a heat source or in direct sunlight.
23. Do not place the device in a dusty or damp place.
24. Do not place the device in an unfavorable location.

Important notes:

- *Make sure that you have the appropriate operating licenses before transmitting on the amateur radio frequency band.*
- *Make sure that the connected antenna is suitable for transmitting on the set frequency and with the set output power before you actually transmit.*
- *The device can become very hot during continuous and long-term transmissions (e.g., FT8 operation). Please extend the transmission pauses accordingly and ensure sufficient dissipation of the heat generated.*
- *Please set up the device in a safe and reliable place and keep it away from children or unauthorized persons.*

3.2 Electromagnetic interference

When using wireless LAN or Bluetooth devices, please note that other wireless devices such as wireless mice, wireless keyboards and wireless routers operating in the same frequency band may interfere with each other, resulting in an unstable or interrupted connection of the device. In such a case, please stay away from other devices or stop using these devices.

3.3 Notes on the battery included

This device contains a lithium-ion battery. Improper use may result in hazards such as smoke, fire or battery breakage.

- The battery pack is installed in the rear panel of the device. Do not knock against the rear panel of the appliance.
- Do not place the device in a location where the temperature may exceed 60 °C; otherwise, the housing may break or catch fire.
- Do not place the back of the device near heat sources such as ovens or direct sunlight.
- Do not solder, disassemble or modify any of the included components yourself. This can lead to failure of the device protection and damage to the components, which in turn can lead to fire hazards and other dangers.
- In the event of obvious deformation, leakage or noticeable odor at the installation site of the battery pack, the device must not be used any further and the dealer must be contacted immediately for assistance.
- Do not use the device outside its temperature range; otherwise, the service life of the device and the battery pack may be shortened or damaged.
- Do not leave the battery pack in a fully charged or fully discharged state for a long period of time. Otherwise, the battery life will be shortened. Please keep the charge level of the battery pack at 40%~50% if the device is left unused for a long time, and then store it properly.
- The service life of the built-in battery pack is usually about 3~4 years. Please replace the battery pack when its service life reaches this period. Even if the battery pack is still working, its performance will be significantly reduced and the operating time will be greatly shortened. The battery pack can generally be charged and discharged 300 to 500 times. This depends on the specific conditions of use.
- Do not charge the device with other, non-compliant chargers.
- Pay attention to the condition of the device when charging. Interrupt the charging process immediately if you notice an anomaly.
- Do not charge the device in vehicles in direct sunlight.

4 Maintenance and care

To ensure the best performance and extend the service life, you should familiarize yourself with the following maintenance and care measures.

4.1 Maintenance

1. Please do not scratch or puncture the device with hard or sharp objects.
2. Do not expose the device to direct sunlight or an environment where electronic circuits may corrode.
3. Do not carry the device by the hand-held microphone or any connection cables connected to the radio.
4. Opening or modifying the device will void any warranty.
5. The use of firmware not intended by the manufacturer for use with the device will invalidate any warranty.

4.2 Care

1. Please clean your device regularly with a dry, clean cloth or a soft brush to wipe the dust off the surface.
2. The keypads, the control knob and the housing of the device can become dirty through use. Please use non-woven cloths for cleaning.
3. Do not use chemical cleaning agents such as alcohol, sprays or petroleum products on the surface of the device or the printed labels. Chemicals can damage the housing and display and remove the print. Before switching on the radio, please make sure that the device is completely dry.

5 General information

The Xiegu X6100 is an ultra-portable short-wave transceiver that adopts the high-performing SDR software radio platform architecture with powerful baseband and RF units, transmitting and receiving separated dual-channel structure and 24bit sampling which with a large dynamic range RF front-end unit, can obtain extremely high radio transmitting and receiving indicators.

The whole device integrates rich and varied operational functions and desktop-radio-like functions, such as recording transmissions, using a variable bandwidth digital filter, digital noise reduction and so on, which brings you a new understanding and experiences in amateur radio. With a compact structure and appearance, you can immediately start on a journey, getting closer to nature and enjoying the fun of outdoor communication.

- HF/50 MHz full mode (supporting data communication)
- Transmitting power:
 - with external power supply: 10W
 - with built-in Lilon battery: 5W
- 4-inch high-resolution color screen (800*480)
- Built-in large capacity lithium battery pack (3000 mAh, 8.4 V)
- Built-in efficient automatic antenna tuner
- Integrated standing wave scanner and voice pager
- Integrated modem, preset message, CW automatic call
- Built-in Bluetooth/WLAN function, which can support wireless keyboard and mouse operation
- Integrated USB line control/transmission, supporting USBHOST.
- Standard high-stability TCXO internal clock source

We strongly recommend that you read this extended manual in its entirety to familiarize yourself with the operation and control methods of the Xiegu X6100 before using it for the first time.

To carry out effective transmission, it is necessary to obtain the corresponding amateur radio operation qualification and apply for the station setup license. Transmission activities in your country shall not be carried out in non-amateur frequency bands.

6 What is included in the scope of delivery?

Thank you for purchasing a Xiegu X6100 from Radioddity. We recommend that you first check the delivery list below and keep the packaging for later storage. If anything is missing or damaged, please contact your dealer immediately.

6.1 Delivery list for the Xiegu X6100

Part	Picture
Xiegu X6100	
Power cable	
Hand-held microphone and spiral connection cable with RJ45 plugs on both ends	
Plug-in charger 12V@1000mA DC (Only for charging the battery!)	
USB-A to USB-C cable	
Warranty Card	
Xiegu X6100 Operation manual	

Note: You can find further accessories for your radio at:

<https://www.radioddity.com/>

7 Operating controls and connections of the Xiegu X6100

The Xiegu X6100 has a large number of controls and connections. These are located on the front, on both sides and on the top of the radio.

7.1 Controls on the front of the Xiegu X6100

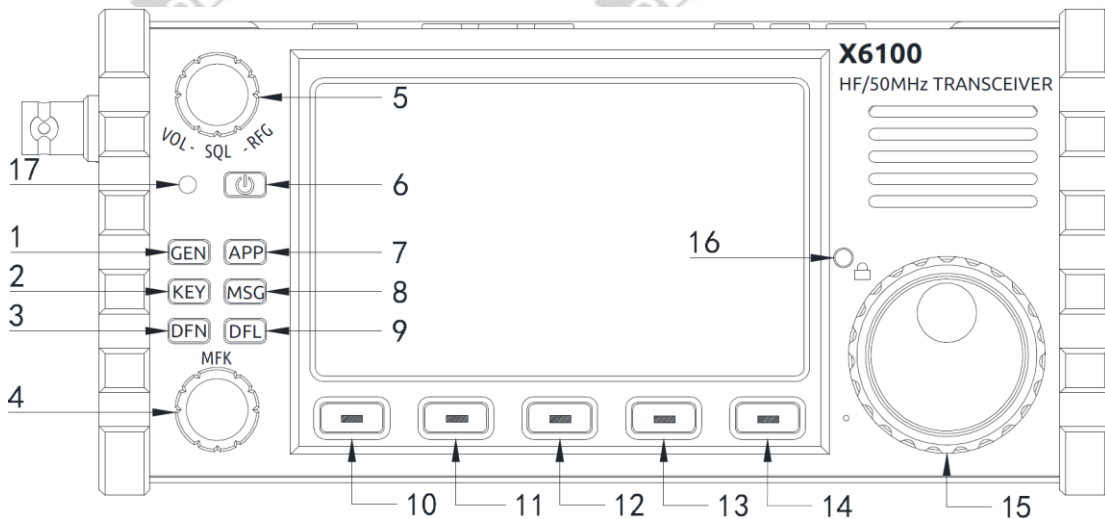

No.	name	function
1	GEN button	Press this button to activate the softkeys for 'General settings'.
2	KEY button	Press the button to call up the softkeys for 'Morse code' keyer settings.
3	DFN button	Press this button to call up the digital filter softkeys menu.
4	MFK rotary control & button	The multifunction knob is used to select values (turn) and to confirm an entry (press).
5	VOL/SQL/RFG rotary control & button	<ul style="list-style-type: none"> • Default: Volume control • Press the button to set the SQL muting depth. • Press the button again to set the RFG gain.
6	Power button	<ul style="list-style-type: none"> • Press and hold the button to switch on the transceiver power supply. • Press and hold the button for 1 second to switch off the transceiver's power supply.
7	APP button	Press the button to call up extra functions <i>RTTY/BPSK/CW-MODEM</i> , <i>SWR SCAN</i> or <i>VOICE CALL</i> . pressing any of the other function buttons will exit the APP softkeys
8	MSG button	This button is used with the <i>MODEM</i> and <i>Voice Keying</i> functions.

No.	name	Function
9	DFL button	Press the button to edit the setting of the three digital bandwidth filters.
10	Softkey	Press this button to execute the function displayed on the screen immediately above the button.
11	Softkey	Press this button to execute the function displayed on the screen immediately above the button.
12	Softkey	Press this button to execute the function displayed on the screen immediately above the button.
13	Softkey	Press this button to execute the function displayed on the screen immediately above the button.
14	Softkey	Press this button to execute the function displayed on the screen immediately above the button.
15	Main rotary knob	Turn this knob to change the radio's frequency depending upon the increment set.
16	Button for locking the radio	<ul style="list-style-type: none"> • Press and hold for 1 second to lock the radio. • Press again for 1 second to unlock the radio. • Short presses of this button adjust the backlight level on the LCD display.
17	Status LED	<ul style="list-style-type: none"> • The indicator lights up green after powering on. • When the Xiegu X6100 is in transmission mode, the indicator light turns red. • When the Xiegu X6100 is switched off with the battery pack being charged, it flashes green.

7.2 Operating controls on the top of the Xiegu X6100

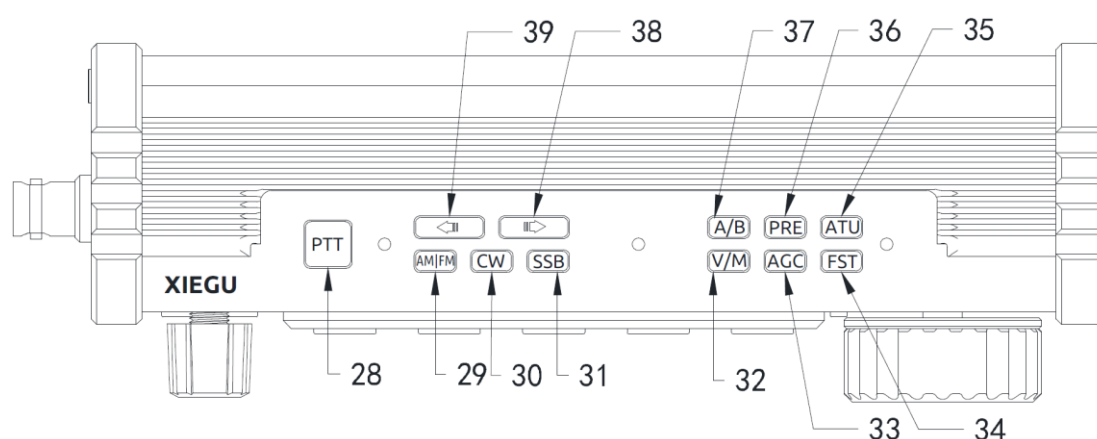

No.	name	function
28	PTT	Push To Talk button on the device housing
29	AM / FM	Switch to select AM/FM mode (AM, NFM)
30	CW	Switch to select CW mode (CW, CWR)
31	SSB*	Switch to select SSB mode (LSB, L-DIG, USB, U-DIG)
32	V/M (M→V)	Variable Frequency/Memory channel operation switching
33	AGC (SPL)	AGC (slow, fast, auto, none) long press to engage split frequency operation
34	FST (MENU)	Push-button for frequency increment step position (kHz, 100Hz, 10Hz)
35	ATU (TUNE)	Engage/disengage built-in antenna tuner, long-press button for antenna tuning
36	PRE (ATT)	Button to engage/disengage preamplifier long-press button to engage/disengage attenuator
37	A/B (A=B)	Button to select VFO-A or VFO-B
38	⇒	Button to select next higher band/channel
39	⇐	Button to select next lower band/channel

*)

SSB setting	Use case
LSB	Below 10 MHz (160m, 80m, 60m and 40m band)
L-DIG	RTTY
USB	Above 10 MHz (30m, 20m, 17m, 15m, 12m, 10m, 6m)
U-DIG	All digital modes

7.3 Connections on the left-hand side of the Xiegu X6100

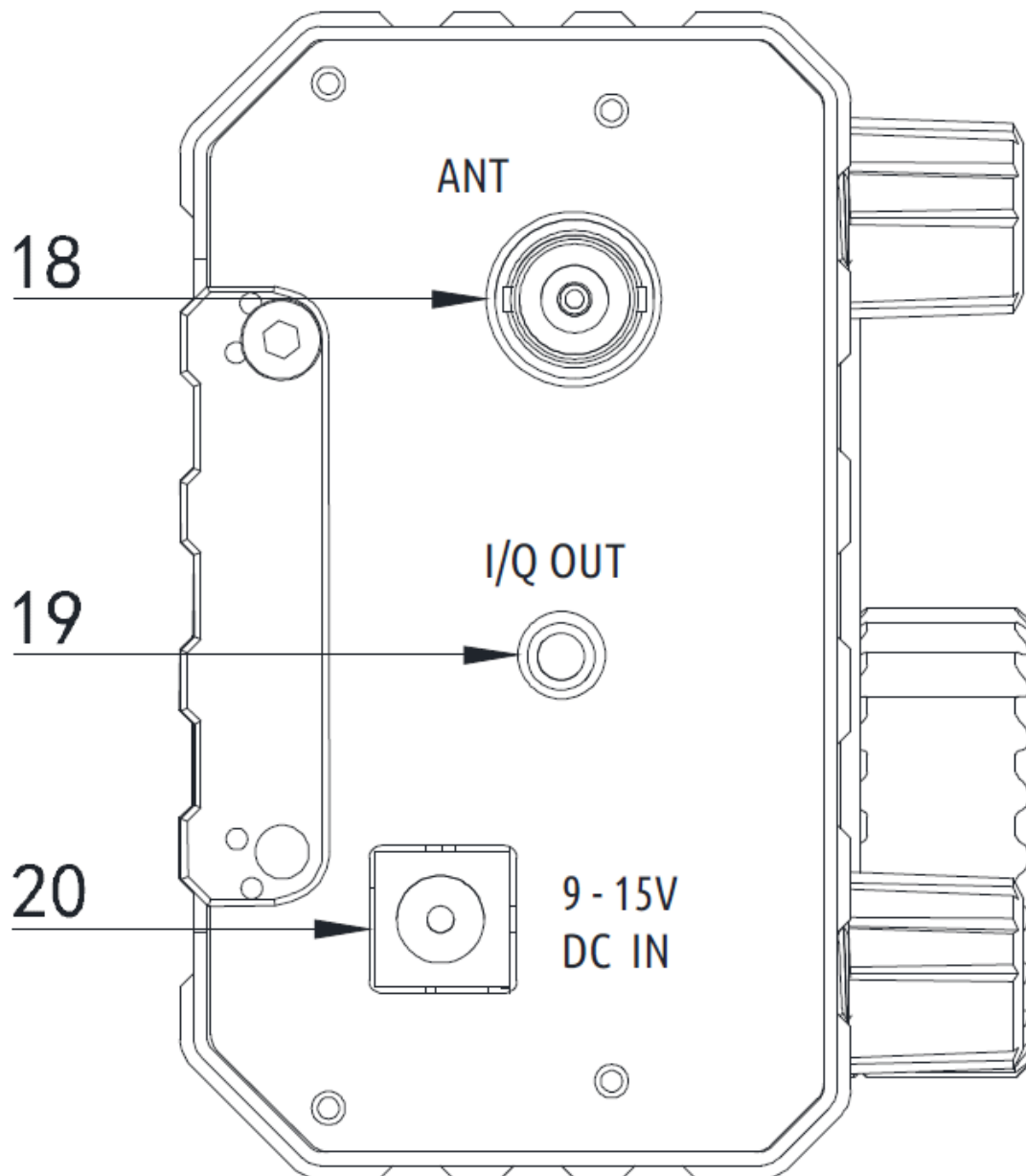

No.	name	function
18	ANT	BNC socket, 50Ω, for antenna connection
19	I/Q OUT	IQ signal output, 3.5 mm TRS
20	DC IN	Connection for external power supply, plug type 5525 (5.5mm external: - ; 2.5mm internal: +). Also used to charge the internal battery.

7.4 Connections on the right-hand side of the Xiegu X6100

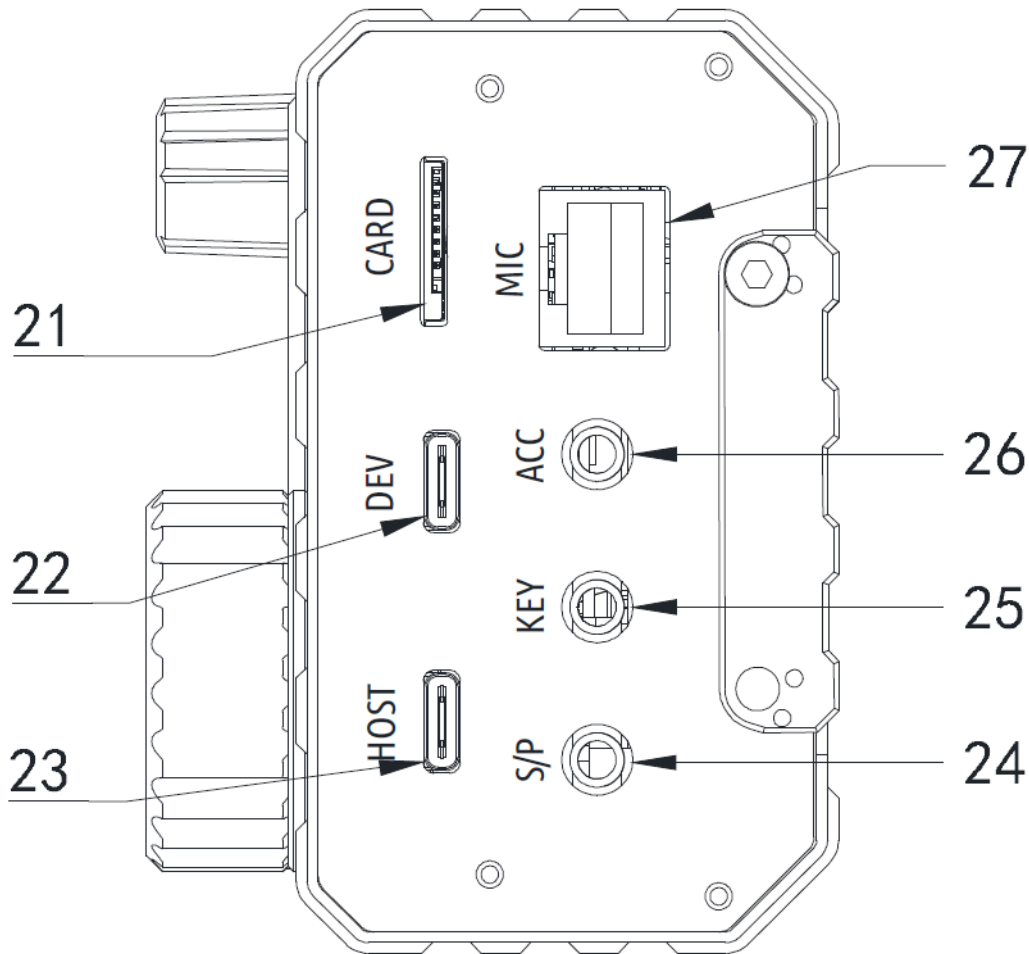

No.	name	function
21	CARD	Slot for microSD/TF memory card
22	DEV	USB-C Port (Slave) (Xiegu X6100 acts as device)
23	HOST	USB-C Port (Host) (Xiegu X6100 acts as server/host)
24	S/P	External loudspeaker/headphone interface. Speaker or headphone output can be set via the menu. This is a STEREO style 3.5 mm TRS interface. Attention: A mono jack plug causes a short circuit in the output and can damage the device.
25	KEY	This is a 3.5 mm TRS interface for connecting a manual/automatic Morse code key. See chapter 7.6 on page 22.
26	ACC	This is a 3.5 mm TRS interface for connecting to accessories. See chapter 7.6 on page 22 for details.
27	MIC	Connection for the supplied hand-held microphone. The interface is of the RJ45 type. For Details see chapter 7.6 on page 22.

7.5 Operating controls located on the Xiegu hand-held microphone

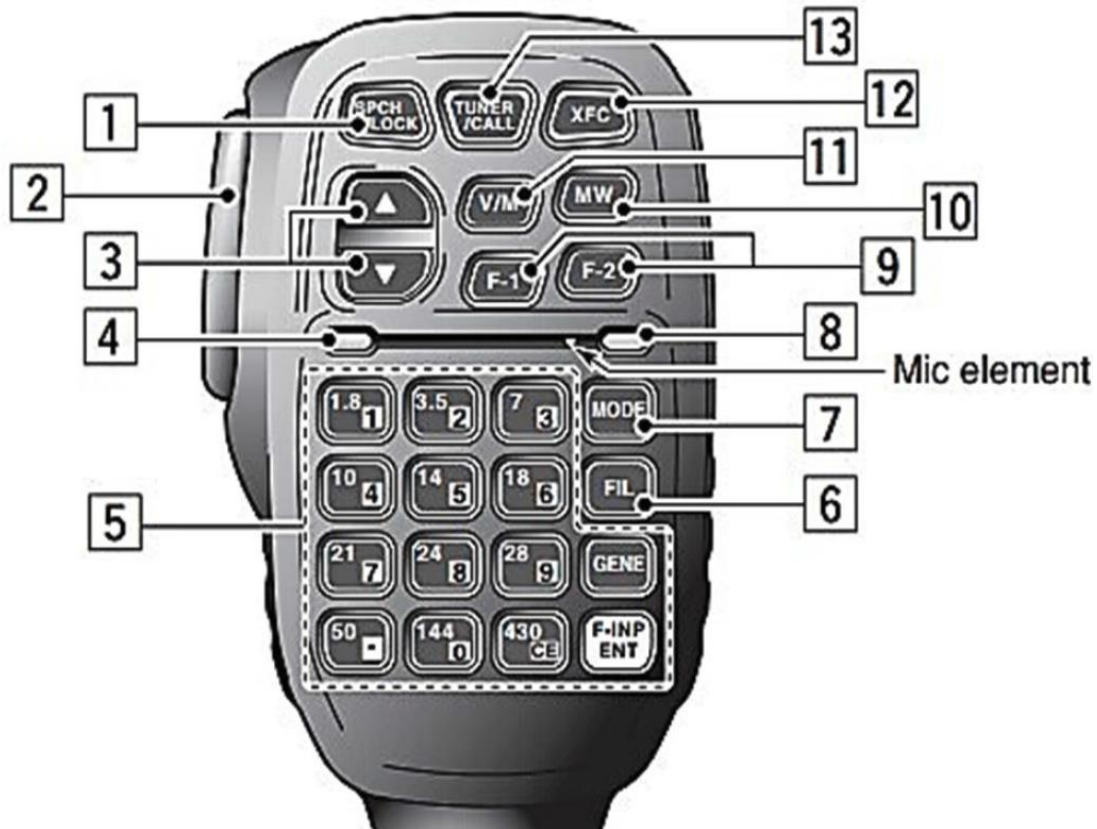

No.	name	function
1	LOCK	Lock all keys to protect from accidental change.
2	PTT	PTT (Push to talk) button
3	↑ / ↓	Button for increasing/decreasing the operating frequency or for selecting a memory channel
4	Status-LED	Radio powered up indicator for the hand-held microphone
5	Keyboard section	Numeric keypad
6	FIL button	Bandpass filter selection (1...3)
7	MODE button	Selection of operating mode (AM, NFM, CW, CWR, LSB, L-DIG, USB, U-DIG)
8	Function LED	LED indicator for functions
9	F1 / F2	Function keys F1 & F2 (user-defined, see section 10.1.2.4 on page 43)
10	MW button	Write current frequency to memory channel
11	V/M button	Switch between variable frequency and memory channel modes
12	XFC	Exchange frequencies of VFO-A and VFO-B
13	TUNER/CALL	Activate/Tune using built-in antenna tuner

7.6 Electrical connection diagrams for the Xiegu X6100

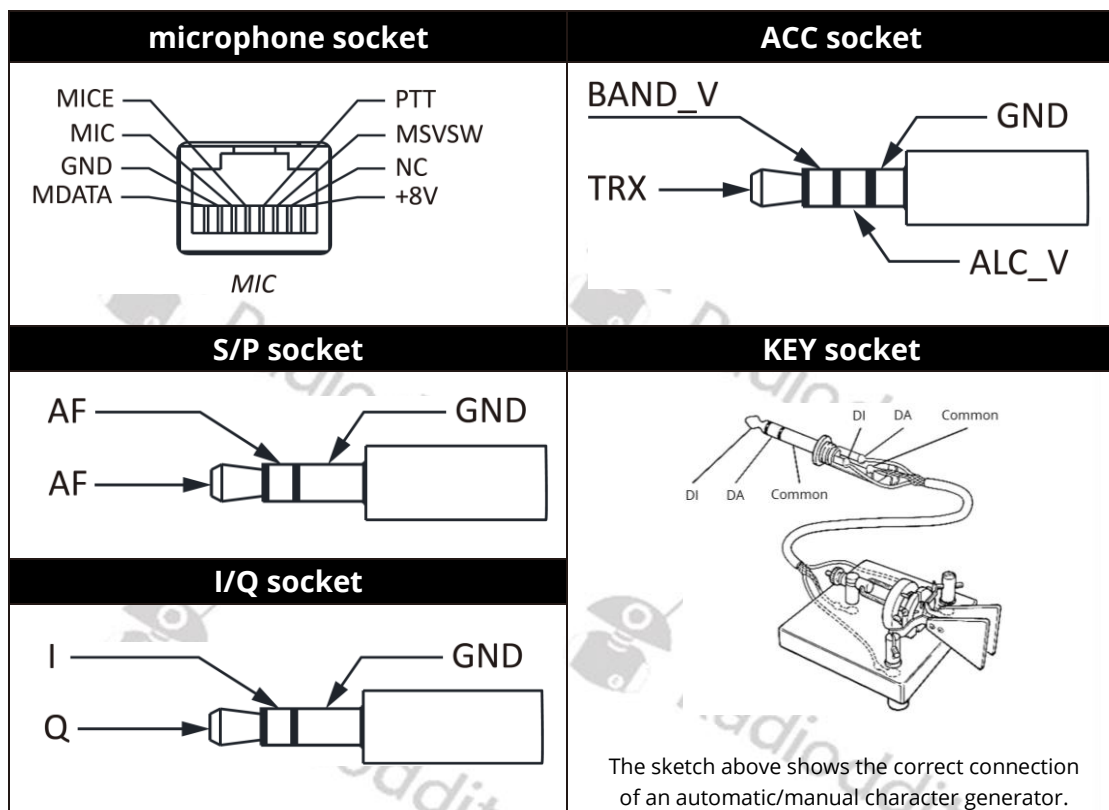

Notes on the use of Morse keys:

- If the plug of the manual Morse code transmitter has a 2-wire 6.5 mm mono jack plug, please replace it with a 3-wire 3.5 mm stereo jack plug according to the wiring method shown in the figure above, and connect the hot end of the Morse key to the 'Di' or 'Da' connector.
- Note that direct use of a mono to stereo adapter or incorrect wiring may cause the radio to be in CW transmit status all the time.
- The use of jack plugs with specifications other than those mentioned may damage the jack socket.
- When the Xiegu X6100 is switched on, the radio may switch to transmit mode when you plug in or unplug the jack plug.
- Please disconnect the power supply of the Xiegu X6100 before plugging or unplugging the jack plug.

7.7 Connecting to an external power supply

An external 13.8 V DC power supply can be used to power the Xiegu X6100. However, the current rating of the DC power supply must be at least 3.5A. The power supply must be connected as shown in the following diagram to avoid reversing the polarity of the Xiegu X6100.

The positive connection of the power supply unit must be connected to the centre 2.5mm socket of the plug.

The negative connection of the power supply unit, on the other hand, must be connected to the outer 5.5mm connection of the plug. Check the correct polarity **before** inserting the plug into the socket of the Xiegu X6100.

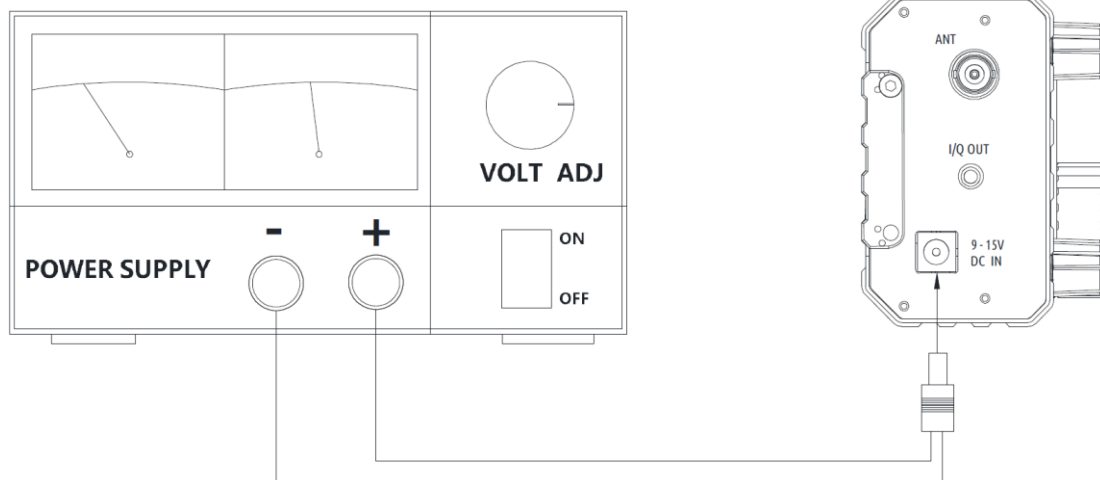

To prevent external interference from entering the radio via the power lines and to prevent radio frequency interference in the radio from being radiated to the outside via the power lines when the Xiegu X6100 is operated with an external power supply, additional Clip-on EMC ferrite rings can be attached to the DC supply cable. If possible, the ferrite rings should be attached close to the radio.

7.8 Charging the battery pack

If the voltage of the internal battery pack drops below 7.4 V during operation, the Xiegu X6100 temporarily deactivates the transmission function. If the voltage drops below 7.2 V, the Xiegu X6100 will switch off completely to protect the internal battery pack from excessive discharge.

To charge the Xiegu X6100, only use the supplied plug-in charger. Plug the AC connector of the charger into the mains and the 5.5/2.5 mm hollow plug of the output connector into the DC IN socket on the left-hand side of the Xiegu X6100 to charge the internal battery pack (the internal charge controller should have been switched on in the 'RADIO SETTING1' menu beforehand). It takes about 6 hours to fully charge the battery pack. The battery voltage is then around 8.3V...8.4V. After charging, the Xiegu X6100 automatically switches off the internal charge controller.

When switched off and during charging, the status LED of the Xiegu X6100 behaves as follows:

- Battery pack is charging: flashing green
- Battery pack is fully charged: green continuous
- Charging error: flashing red
- No charging of the battery pack taking place: Status LED off

Note:

- When using an external power supply, the polarity of the connection cable must be checked carefully beforehand to avoid reverse polarity.
- Incorrect connection of the power supply can lead to serious damage to the radio.
- Do not charge the radio with a charger that does not comply with the specifications. Otherwise, the device may be damaged.

Attention! *The plug-in charger is only used to charge the battery pack contained within the Xiegu X6100 and cannot be used for transmitting, as there is a risk of damaging the device.*

The DC connector on the left side of the Xiegu X6100 must not be connected to a voltage higher than 15V DC under any circumstances. Doing so may result in serious damage to the device.

8 Screen display

Depending on the firmware version used, the display of the main screen may differ slightly from the following explanations.

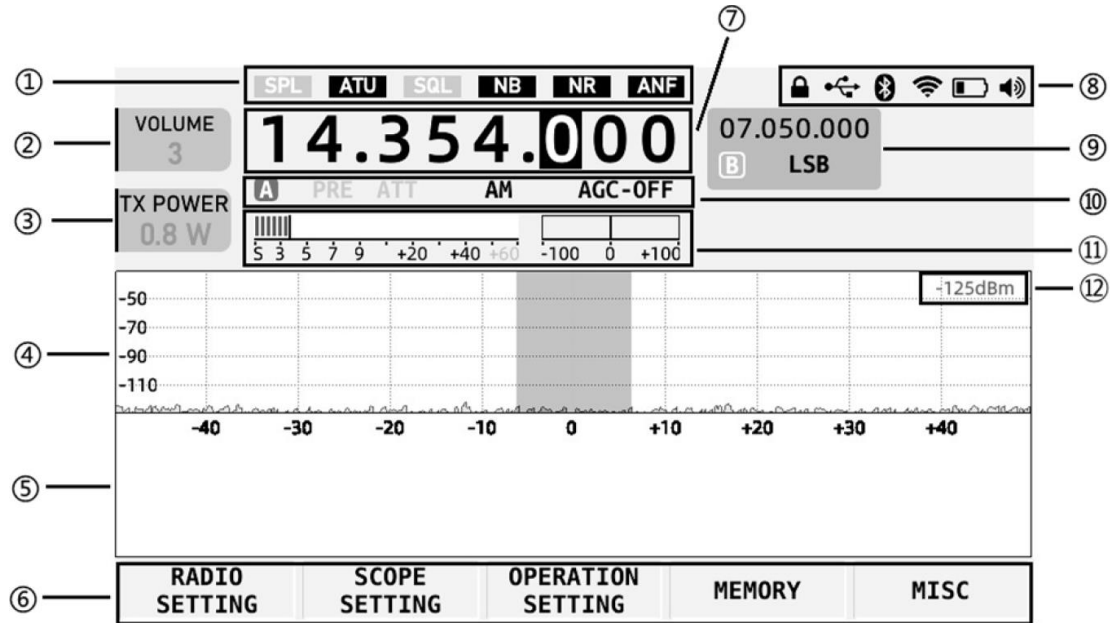

#	name	function
1	Status 1	The status of the SPL, ATU, VSQ, NB, NR and DNF switches are displayed in this area.
2	Volume panel	Display of the volume/squelch level/RF gain setting. Briefly press the volume control to switch between the three states mentioned above.
3	Multi-function panel	The picture shows the current value of the selected shortcut. The use of the display field can be set via the shortcut functionality of 'RADIO SETTING1' and 'RADIO SETTING2'.
4	Snapshot of the receive frequency spectrum	Displays the received signal strength from approximately minus 122 dBm.
5	Waterfall display	Waterfall of received signals over time
6	Area of the multifunction menu	Briefly press the corresponding button below the field to activate the corresponding functions.
7	Main VFO frequency	Display of VFO-A frequency



#	name	function
8	Status 2	The status is displayed in this area, including control lock/USB connection/Bluetooth/WLAN/battery/volume/WFSERVER.
9	VFO-B	Display of VFO-B frequency
10	Status 3	The PRE/ATT/Mode/AGC status is displayed in this area.
11	Table header area	The S value and the standing wave ratio are displayed in this area (the display therefore differs from the illustration)
12	Signal strength	Display of received signal strength in dBm
13	Audio spectrum	Audio spectrum display (not shown in previous diagram) but in the bottom right hand corner of the screen above the softkey bar (see below)

Picture (Firmware - APP V1.1.6, BASE V1.1.6):



9 Basic operation

9.1 Turning the Xiegu X6100 on/off

1. Press the power button  for 1 second to turn on the radio.
2. Press the power button  again for 1 second to turn off the radio.



9.2 Setting the volume

1. If not already operating as the volume control (default) press the VOL/SQL/RFG knob several times to select the **VOLUME** option. The label on the top left-hand corner of the LCD shows **VOLUME**. 
2. Turn the VOL/SQL/RFG knob to the left or right to set the output volume between 0 and 55.



9.3 Selecting the operating frequency band and operating mode

Follow the instructions below to select the frequency band and set the mode. Frequencies outside the amateur radio band can only be received, it is not possible to transmit on these frequencies.

Note: Depending upon IARU region and local country regulations some amateur HF bands are defined with different frequency limits and it is ALWAYS the responsibility of the amateur to ensure he does not transmit out-of-band.

Press the corresponding mode button on the top of the radio to switch to the corresponding mode.

1. Press the [←] or [→] button to select from the available frequency bands: 1.8MHz - 3.5MHz - 7MHz - 10MHz - 14MHz - 18MHz 21MHz - 24MHz - 28MHz - 50MHz
2. The labelled buttons on the hand-held microphone can also be used to select a frequency band directly. The buttons for 144 MHz and 430 MHz on the hand-held microphone have no function as the Xiegu X6100 does not support these bands.

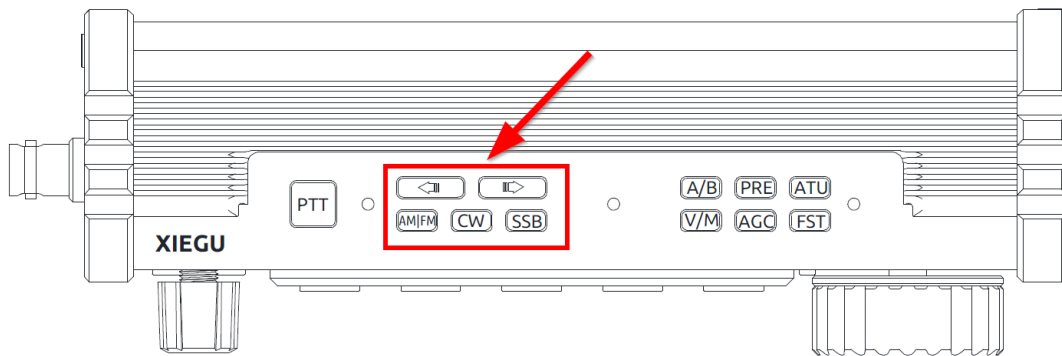

9.4 Setting the operating frequency

1. Turn the large knob to set the frequency. Turn the knob clockwise to increase the operating frequency and counterclockwise to decrease the operating frequency.
2. Press the [FST] button on the top of the Xiegu X6100 to change the frequency step width between 1 kHz, 100 Hz and 10 Hz.

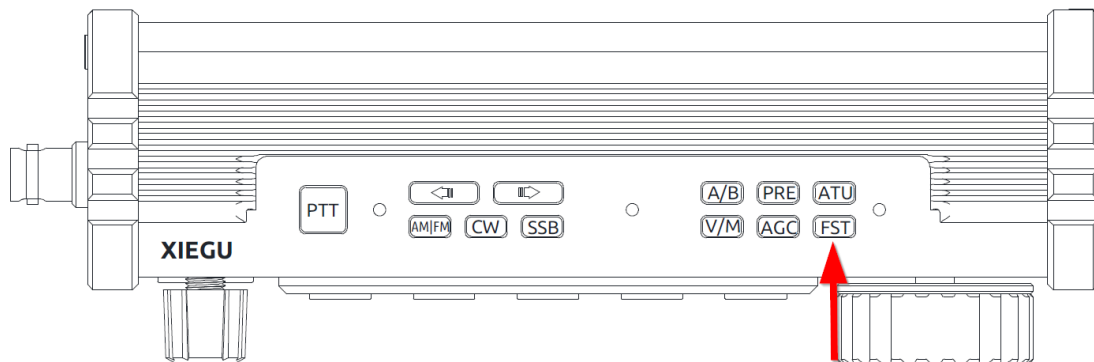

- Then use the large rotary knob to change the operating frequency which will jump in the set frequency step width.



- To set the operating frequency directly on the hand-held microphone, press the [F-INP/ENT] button on the hand-held microphone (bottom right). The previous frequency is no longer displayed. Instead, you will see a flashing cursor at the first digit of the frequency display. Now enter the desired operating frequency using the numeric keypad on the hand-held microphone and then press [F-INP/ENT] again to confirm your entry

For example, if you want to set an operating frequency of 14.25000 MHz, press the following buttons one by one:

[F-INP/ENT] [1] [4] [.] [2] [5] [0] [0] [0] [0] [F-INP/ENT] or just
[F-INP/ENT] [1] [4] [4.] [2] [5] [F-INP/ENT]

9.5 Setting the RF gain and squelch level

A suitable RF gain of the input signal can help to improve the quality of the received signal. In general, an appropriate reduction in RF gain on the lower bands which suffer with strong interference can significantly improve hearing performance.

Setting the RF gain:

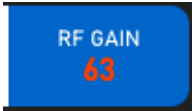
- Press the volume control in repeatedly to select the **RF GAIN** option. The label on the top left-hand corner of the LCD shows **RF GAIN**. 
- Now turn the volume control to set the RF gain value between 0 and 100 (a good starting position is 63 as shown).

Setting the squelch level:

If muting is required for signals or sounds below a certain amplitude, a suitable squelch level can be set to mute the audio when no strong signal is present.

- Press the volume control knob several times to select the **SQL THR** option. The label on the top left-hand corner of the LCD will show **SQL THR**. 

2. Now turn the volume control knob to set the squelch level between 0 and 100. As soon as the squelch level is no longer 0, the **'VSQL'** label is also shown on the LCD in the 'Status 1' area.



9.6 Using VFO-A and VFO-B (A/B / A=B)

By briefly pressing the [A/B] button, the VFO in use can be switched between VFO-A and VFO-B. (both VFOs are used in split frequency operation).



If you press and hold the [A/B] button (this corresponds to the 'A=B' function), the current frequency and mode in the main frequency display (regardless of which VFO it is assigned to) is also transferred to the other VFO.



9.7 Preamplifier/attenuator (PRE / ATT)

The preamplifier can improve the reception level of weak signals on the higher bands.

The attenuator can reduce the interference caused by strong signals on the reception characteristics.

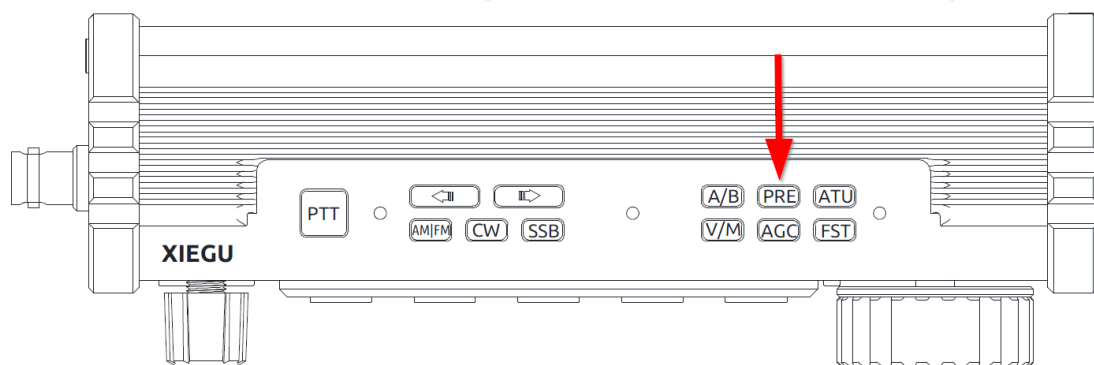

1. Briefly press the [PRE] button on the top of the Xiegu X6100. The **PRE** label will then appear in the 'Status 3' field to indicate that the preamplifier has been switched on.



2. Briefly press the [PRE] button again to switch the preamp off again. The **PRE** label in the 'Status 3' field is then grayed out to indicate that the preamplifier is switched off.

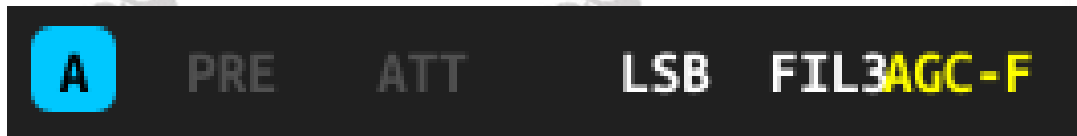

3. However, if you press and hold the [PRE] button on the Xiegu X6100, the label **ATT** will appear in the 'Status 3' field to indicate that the attenuator has been switched on.

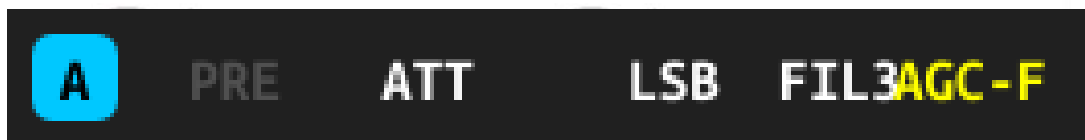

4. Press and hold the [PRE] button again to switch the attenuator off again. The **ATT** label in the 'Status 3' field is then grayed out to indicate that the attenuator is switched off.

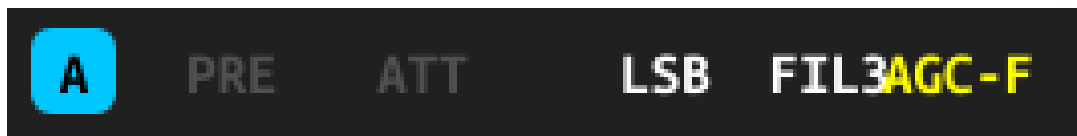

It is recommended not to use the preamplifier in the frequency bands below 14 MHz so that the radio is set to the straight-through state, which improves front-end performance of the receiver and reduces the effect of interfering signals.

If the level indicates that a received signal exceeds 40dBm, it is recommended to switch on the attenuator to prevent the receiver from being overloaded by the excessive input signal level.

9.8 Automatic antenna tuner / tuning (ATU / TUNE)

The Xiegu X6100 has an internal antenna tuner. This should be used to achieve the best possible impedance match to the connected antenna at the selected operating frequency.

1. Briefly press the [ATU] button on the top of the housing to switch on the antenna tuner. In the 'Status 1' field, the switched-on antenna tuner is indicated by **ATU** being displayed.



2. Press and hold the [ATU] button on the top of the housing to initiate the matching of the connected antenna to the currently set operating frequency. This only takes a few seconds. The status LED of the Xiegu X6100 lights up red during this time, as the Xiegu X6100 has to transmit a signal for tuning. At the same time, you will hear a signal tone from the loudspeaker. After tuning, the device automatically returns to receive mode

Note:

1. If you press the [ATU] button briefly, the **ATU** symbol appears in the 'Status 1' field, indicating that the antenna tuning functions are engaged. The ATU is now in circuit however the antenna is not yet matched.
2. After the antenna has been matched (by pressing and holding the [ATU] button), the antenna tuner must remain active in order to retain the match.
3. If the **SWR** symbol at the top of the LCD flashes as soon as transmission is tried following the ATU matching operation it indicates that the antenna is still reflecting too much power back and a second 'tuning' action is recommended.
4. With a resonant antenna on the band in use connected to the radio, there is no need to have the ATU engaged.
5. When using a loaded whip antenna be aware that even during the tuning action no one should be near the antenna. Until the antenna is correctly matched strong radio frequency interference to neighboring electronic devices is possible.

9.9 Using the station memory (V/M / M→V)

You can switch between VFO operating mode and channel memory mode by briefly pressing the [V/M] button. When memory mode is active, either the memory location (M1...M200) or the assigned name and the stored frequency are shown on the display. The selected memory location can be changed using the [⇐] and [⇒] buttons on the top of the Xiegu X6100 as well as the [↑] and [↓] buttons on the hand-held microphone.

If a new memory location has been selected and its settings are now to be used as VFO settings, a long press on the [V/M] button is sufficient to transfer the selected memory location to the VFO main frequency display.

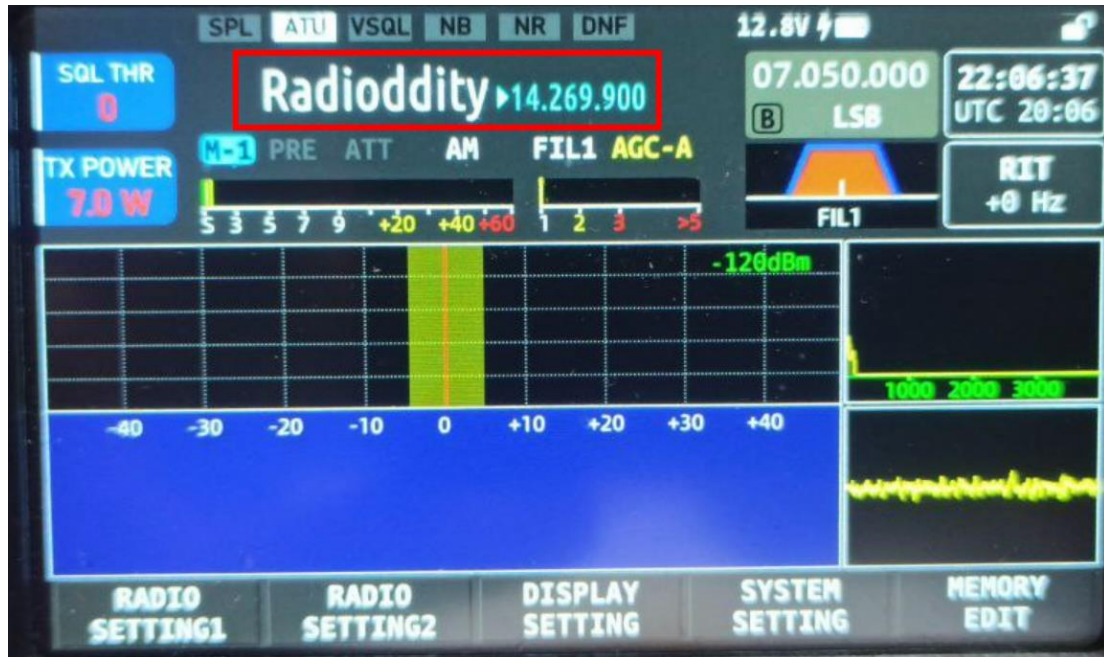

9.10 Automatic gain control / split-frequency operation (AGC / SPL)

Depending on the operating mode, select the appropriate gain control to achieve the best possible reception quality.

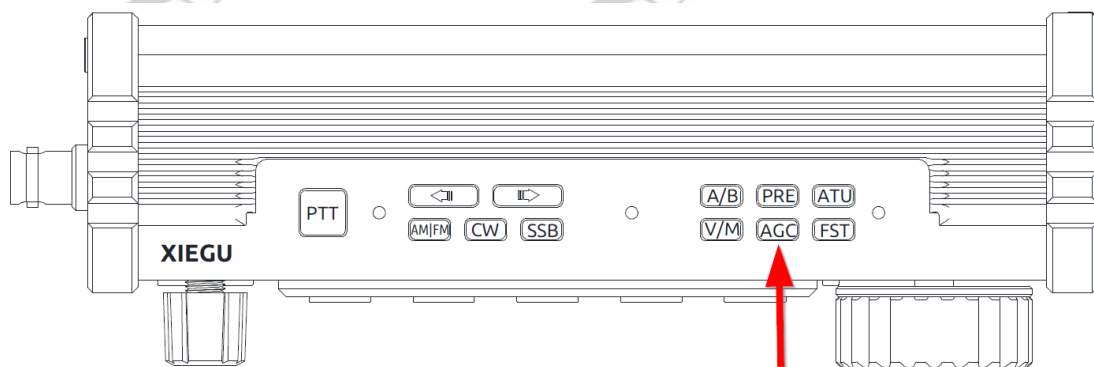

Briefly press the [AGC] button on the top of the Xiegu X6100 to select from the various AGC modes. The following modes are available:

AGC-Mode	Automatic Gain Control
AGC--	turned off
AGC-F	fast
AGC-S	slow
AGC-A	automatic

The selected gain control is displayed in the 'Status 3' field.

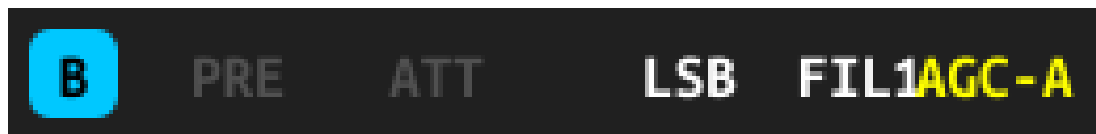

Note: *AGC-S is recommended for AM operation.
AGC-F is recommended for SSB and CW operation.*

Press and hold the [AGC] button to activate/deactivate split frequency mode. The activated split frequency mode can be recognized by the illuminated **SPL** in the 'Status 1' field.

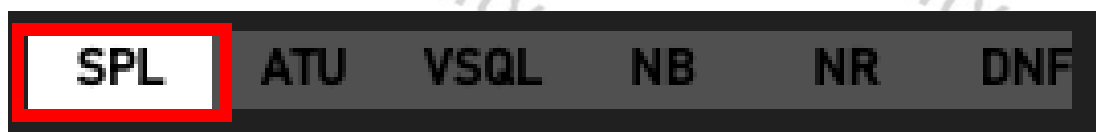

When split frequency operation is switched on, reception takes place on the main VFO frequency (VFO-A) and transmission takes place on the VFO-B frequency. Therefore, the main frequency display changes accordingly when the PTT button is pressed for the radio to go onto transmit.

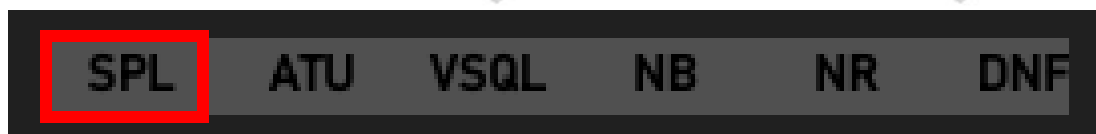

When split frequency mode is switched off (**SPL** is shown in gray in the 'Status 1' field), the two VFOs can be used completely independently of each other and you can switch between the two VFOs by briefly pressing the A/B button on the top of the Xiegu X6100. The operational VFO is displayed as the main VFO frequency.

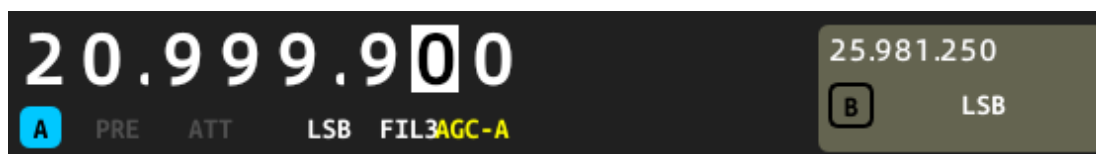

Split frequency operation can also be activated/deactivated via the 'RADIO SETTINGS2' submenu. However, this is much more complicated than a long press on the [AGC] button. Split mode is most often used when calling a DX station in a pile up when you should not transmit on the same frequency as the DX station. Further details can be found in section 10.1.2.3 on page 43.

9.11 Frequency step width / Menu (FST / MENU)

By briefly pressing the [FST] button, you can set the frequency increment by which the frequency is changed when the main tuning knob is turned. Possible frequency steps are 10 Hz, 100 Hz and 1000 Hz (1 kHz).

A long press on the [FST] button currently triggers the same function as a short press on the [FST] button.

9.12 Transmitting (SSB/AM/FM mode)

1. Press the [PTT] talk button on the hand-held microphone to start the transmission. Please speak into the hand-held microphone in a normal voice.
2. During the transmission process, the status LED on the Xiegu X6100 lights up red, as does the status LED on the hand-held microphone.
3. Release the [PTT] talk button again to return to receive mode.

9.13 Transmit (CW mode)

You can use both manual ("straight") Morse keys and automatic encoder ("paddle") units with the Xiegu X6100. The electrical connection is described in chapter 7.6 on page 22.

1. Connect your Morse key to the KEY connector on the right-hand side of the Xiegu X6100.
2. Press the [CW] button on the top of the radio to select between the CW and CWR operating modes. The selected operating mode is displayed in the field 'Status 3'.

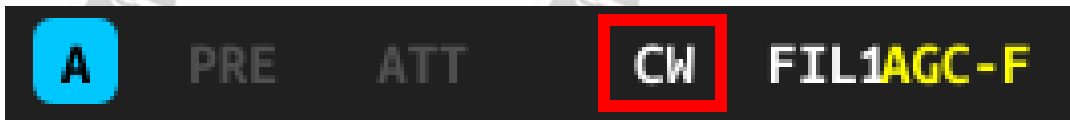

When CW is selected, the upper sideband is used regardless of the band in use. With CWR, however, the lower sideband is used.

3. For decoding set the desired operating mode in the modem submenu ([APP] → MODEM).
4. Use the KEY function key on the front panel to set the remainder of the required parameters.
5. Press your Morse key to start CW communication.

9.14 Using the built-in PTT button for sending

The Xiegu X6100 has a [PTT] button on the top of the radio and a built-in microphone (bottom left, next to the large rotary knob). This makes it possible to use the radio on SSB outdoors without the need for a hand microphone.

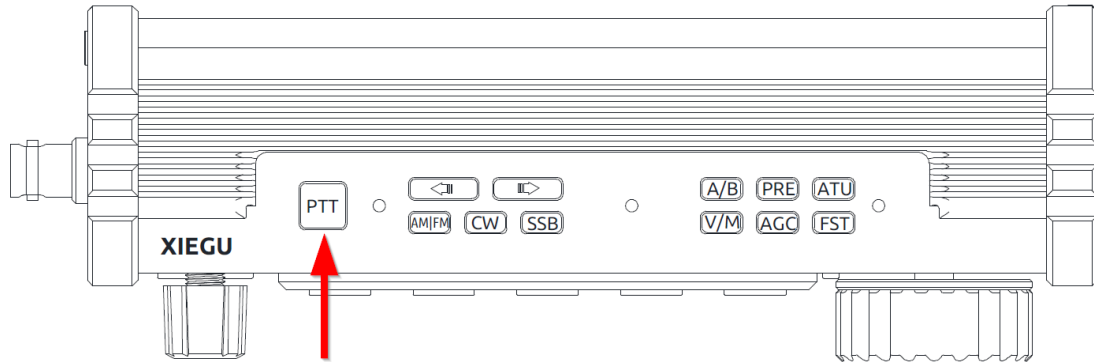

1. Press the [PTT] button on the top of the device and speak into the built-in microphone opening to the left of the large knob to transmit your voice.







2. Release the [PTT] button after transmitting to return to receive mode.

Note: Do not place the antenna too close to or near exposed parts of the body, especially the face or eyes, when transmitting with the radio in your hand. If this is unavoidable, transmit at a correspondingly lower power level.

9.15 Operating lock / display backlight

The large rotary knob can be locked to prevent accidental adjustment of the set operating frequency. The backlight intensity of the LCD also uses this button and brightness can be set at 10 different levels.



1. Press and hold the lock button to disable the change of using the large rotary knob.. The symbol  appears in the top right-hand corner of the LCD.
2. Press and hold the lock button again to re-enable the large rotary knob. The symbol  will then appear again in the top right-hand corner of the LCD.
3. Press the lock button briefly to adjust the brightness of the backlight of the LCD in steps between 1 and 10. The set level   is displayed briefly each time. The level can be set to a level of 1-10 in the General Setting / display settings menu.

10 Multifunction menus

You can directly access the corresponding menus for general functions using the 6 function buttons on the left-hand side of the control panel. After selecting a menu, the possible options appear at the bottom of the LCD as softkeys. Once you have selected a softkey, turn the multifunction knob to set the corresponding parameter value. The setting parameters are displayed in the field 'Status 3'.

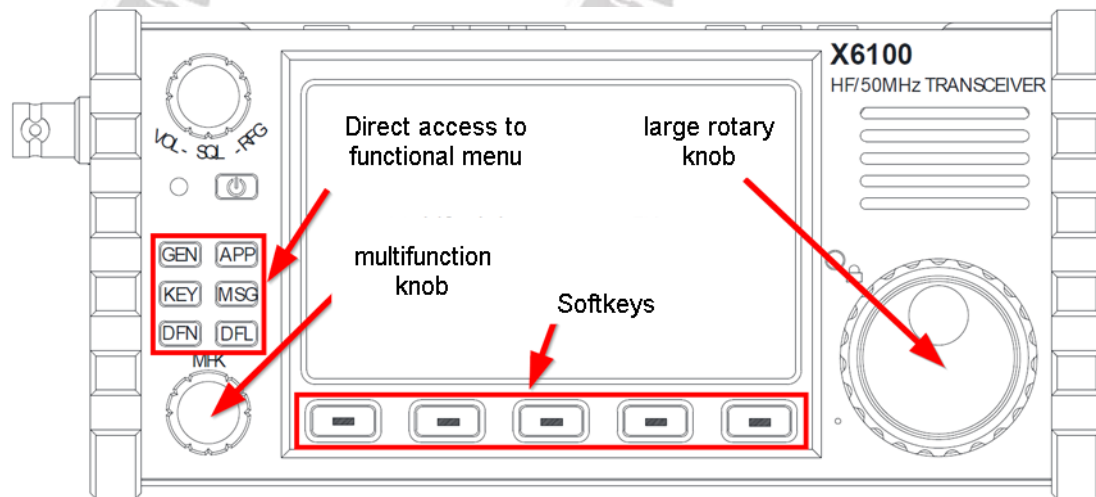



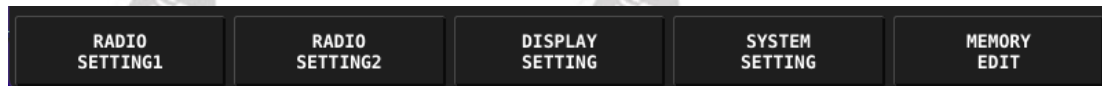

10.1 The GEN function

After briefly pressing the [GEN] button, the general menu appears at the bottom of the LCD.

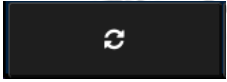

10.1.1 RADIO SETTING1

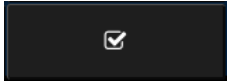
Briefly press the [RADIO SETTING1] softkey to call up the corresponding submenu. You can now change the parameters as described below. The corresponding functions for modifying the parameters are displayed directly above the softkeys in the lower section of the LCD.

Softkey	function
	Restore default value for parameter
	Decrease parameter / previous option
	Increase parameter / next option
	Set as shortcut for MFK rotary knob. The selected parameter is displayed in the multi-function field (the second down from the left-hand corner) in the LCD and can be changed by turning the MFK rotary knob
	Exit the submenu

10.1.1.1 AGC KNEE

The value defines the initial control level of the automatic gain control. Values between -100 dB and -60 dB are permitted.

Default: -60 dB

10.1.1.2 AGC SLOPE

The control gradient of the gain control is determined by this parameter. Values between 0 dB and 10 dB are permitted.

Default: 6 dB

10.1.1.3 AGC HANG

Holding the gain control down after a peak in strength can be turned off and on via this parameter.

Default: OFF

10.1.1.4 TX POWER

The output power of the Xiegu X6100 can be set between 0.1W and 10W via this parameter. Please note that output powers above 5W are only possible if the Xiegu X6100 is being powered by an external power supply. The plug-in charger is not suitable as an external power supply, but only for charging the built-in battery.

Default: 5.0W

10.1.1.5 MIC SEL

This parameter can be used to specify the microphone to be used. Possible options are:

Value	Selected microphone
BUILT IN	The microphone built into the Xiegu X6100 on the left below the large rotary knob is used.
HANDLE	The microphone included in the hand-held microphone is used.
AUTO	The corresponding microphone is used based on which [PTT] button is pressed.

Default: AUTO

10.1.1.6 I-MIC GAIN

This parameter is used to set the microphone gain for the internal microphone. Possible values are 0 to 50.

Default: 20

10.1.1.7 H-MIC GAIN

This parameter is used to set the microphone gain for the hand-held microphone. Possible values are 0 to 50.

Default: 20

10.1.1.8 LINE IN LV

The level of the LINE input can be set with this parameter. Possible values are 0 to 36.

Default: 10

10.1.1.9 LINE OUT LV

This parameter can be used to set the level of the LINE output. Possible values are 0 to 36.

Default: 10

10.1.1.10 MONI LEVEL

The level of the monitor can be set via this parameter. Possible values are 0 to 100.

Default: 0 (off)

10.1.1.11 PTT MODE

The function of the [PTT] button can be defined here. In the 'NORMAL' position, the Xiegu X6100 always goes into transmit mode as long as the [PTT] talk button is held down. In the 'TOGGLE' position, on the other hand, each press of the [PTT] talk button switches back and forth between transmit and receive mode.

Note: *The toggle functionality has not yet been implemented in the firmware.*

Default: NORMAL

10.1.1.12 BANDSTACK

Here you can specify whether you can switch between just the amateur radio bands ('HAM BAND') or all supported bands ('ALL BAND'). This command only controls receive, the other (Shortwave broadcast) bands are only enabled for reception.

Default: HAM BAND

10.1.1.13 S/P MODE

This parameter defines what is connected to the S/P output (on the right-hand side of the Xiegu X6100). Possible values are 'SPEAKER' for connecting a loudspeaker and 'EAR PHONE' for connecting headphones.

Default: SPEAKER

Note: *At present the option does not work as it should. Speaker to headphone switching is achieved by plugging in the (wired) headphones into the 3.5mm "S/P" jack. Indeed, switching to earphone with this option while wired headphones are plugged in at the moment mutes ALL audio.*

10.1.1.14 CHARGER

This parameter is used to specify whether the internal charge control of the included battery pack should be activated ('ON') or not ('OFF'). It is recommended that this is only activated during charging of the included battery pack and deactivated again during normal operation.

Default: ON

10.1.2 RADIO SETTING2

A further 5 parameters can currently be accessed via the second softkey. To do this, briefly press the [RADIO SETTING2] softkey to call up the corresponding submenu. You can now change the following parameters:

10.1.2.1 RIT

The received frequency can be fine-tuned using this parameter. An offset between 1500 Hz and +1500 Hz is possible in 10 Hz increments relative to the displayed frequency. The set value is also displayed on the right-hand side of the main screen, below the date and time information.

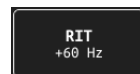

Default: 0

10.1.2.2 XIT

The transmission frequency can also be finely tuned. An offset between 1500 Hz and +1500 Hz is possible in 10 Hz steps relative to the displayed frequency. However, the XIT value is not displayed separately on the LCD (as RIT was).

Default: 0

10.1.2.3 SPLE

You can use this switch to enable split frequency operation (SPLit Enable). When split frequency operation is switched on, reception takes place on the main VFO frequency (VFO-A) and transmission takes place on the VFO-B frequency. Therefore, the main frequency display changes accordingly when the [PTT] button is pressed. When split frequency operation is switched off, the two VFOs can be used completely separately and it is possible to switch between the two VFOs by briefly pressing the [A/B] button on the top of the Xiegu X6100. The selected VFO is displayed as the main VFO frequency.

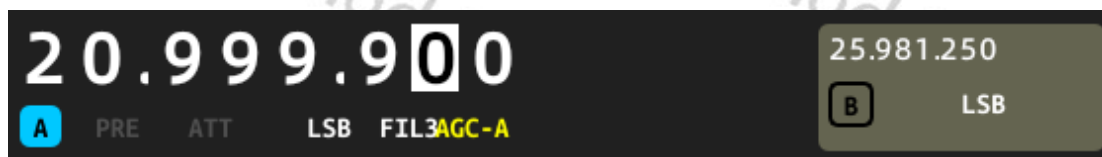

It is much easier to activate/deactivate split frequency operation by pressing and holding the [AGC] button. Details on this can be found in section 9.10 on page 33.

Default: OFF

10.1.2.4 HANDLE F1

This parameter is used to specify which function is to be activated/deactivated when the [F1] button on the hand-held microphone is pressed. Possible functions are:

Option	function
PRE	Preamplifier
ATT	Attenuator
AGC	Automatic gain control
TS-	Each time F1 is pressed, the step width shifts from 1 kHz to 100 Hz to 10 Hz and then back to 1 kHz.
TS+	Each time F1 is pressed, the step width shifts from 10 Hz to 100 Hz to 1 kHz and then back to 10 Hz.

Default: PRE

10.1.2.5 HANDLE F2

This parameter is used to specify which function is to be activated/deactivated when the [F2] button on the hand-held microphone is pressed. You can choose from the following functions:

Option	function
NR	Noise reduction
NB	Noise blanking
DNF	Digital noise filter
CW TRAINER	Training mode for CW

Default: NR

10.1.3 DISPLAY SETTING

Briefly press the [DISPLAY SETTING] softkey to call up the corresponding submenu. You can now change the following parameters:

10.1.3.1 RF FFT AVE

RF spectrum display time domain average. Possible values are 0 to 10.

Default: 0

10.1.3.2 RF FFT REF

The reference range of the RF spectrum display can be set via this parameter. Possible values are -10 dBm to +10 dBm.

Default: 0 dBm

10.1.3.3 FFT SPAN

The bandwidth of the displayed spectrum can be defined with this parameter. Possible values are 100k, 50k, 25k and 12.5k.

Default: 100k

10.1.3.4 FFT PK HOLD

This option can be activated to hold and hence make the peak signal values in the spectrum display visible. Possible values are 'ON' and 'OFF'.

Default: ON

10.1.3.5 WF REF

By setting a waterfall reference level for the spectrum display, it is possible to differentiate between strong and weak signals. This allows the sensitivity of the waterfall display to be increased (positive values) or decreased (negative values). Values between -10 dBm and +10 dBm are possible.

Default: 0 dBm

10.1.3.6 AF FFT AVE

Audio frequency spectrum display time display average. Possible values are 0 to 10.

Default: 0

10.1.3.7 AF FFT REF

The reference range of the audio spectrum display can be set via this parameter. Possible values are -20 dBFs to +20 dBFs. The 'Fs' after the unit stands for 'related to the entire range' (full scale).

Default: 0 dBFs

10.1.3.8 BL LEVEL

The intensity of the LCD backlighting can be set here. Possible values are 1 (very low) to 10 (maximum).

Default: 5

10.1.4 SYSTEM SETTING

Briefly press the softkey labeled 'SYSTEM SETTING' to call up the corresponding submenu. You can now change the following parameters by pressing the MFK rotary knob in after moving over the required option:

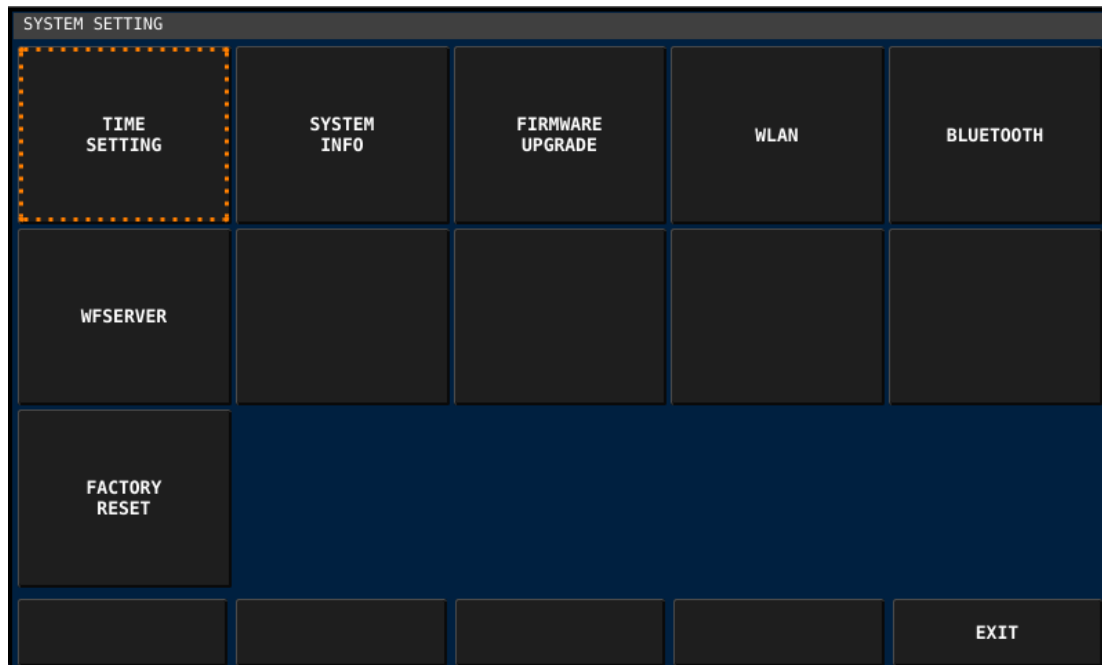

10.1.4.1 TIME SETTING

The Xiegu X6100 has a built-in real-time clock. The clock can be set via an Internet time server using the NTP protocol or manually on the Xiegu X6100. An offset to UTC is also possible.

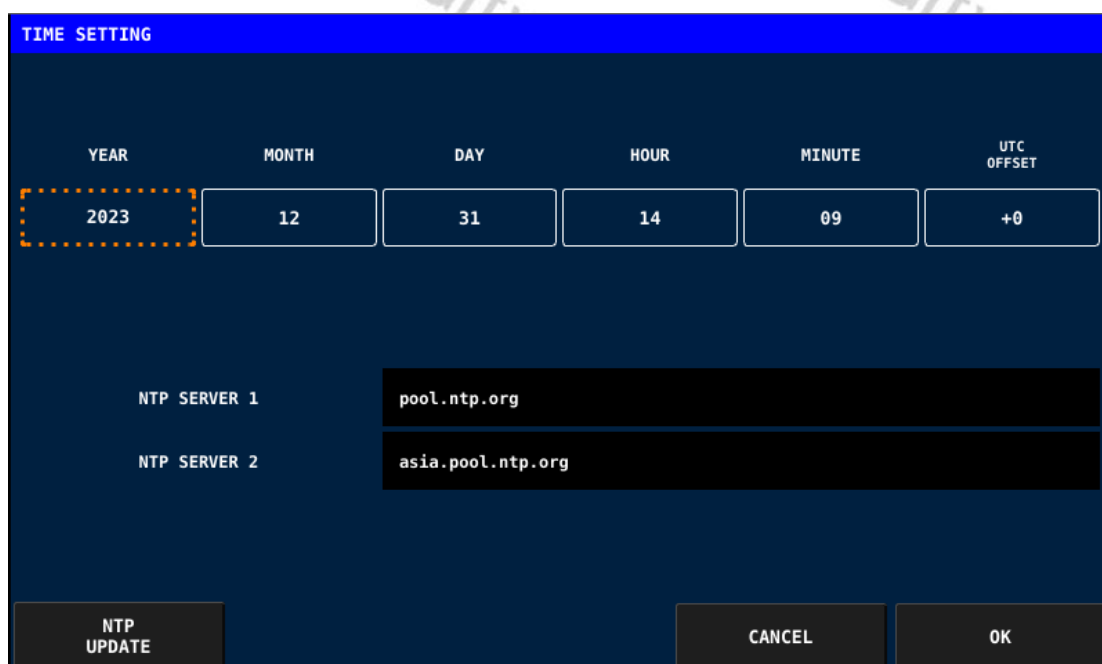

The function of the softkeys is as follows:

Softkey	function
NTP UPDATE	Synchronization of date and time via NTP protocol
CANCEL	Cancel. Previously made changes are lost.
OK	Apply all previously made changes

Pressing the softkey labelled 'NTP UPDATE' triggers synchronization of the date and time using the NTP protocol. Alternatively, the year, month, day, hour, minute and UTC offset can also be set manually.

Use the MFK rotary knob to select the desired parameter and then press the MFK rotary knob to change the selection. If the MFK rotary knob is now turned to the left or right again, the respective parameter is reduced/increased accordingly. If the MFK rotary knob is now pressed again, the previously made change to the parameter is accepted and a further parameter can be selected by turning the MFK rotary knob.

Pressing the 'CANCEL' softkey cancels all previously made changes to the date and time. By pressing the 'OK' softkey, however, they are permanently accepted.

Note: *At present the NTP option does not update the system time, even though the radio is connected to the WLAN with a static address (DHCP doesn't work either – see later). So manual setting of time is required.*

10.1.4.2 SYSTEM INFO

This menu item is used to display the current firmware version of APP (Display unit) and BASE (Main part of the radio). Please note that the version numbers and release dates of APP and BASE are generally not identical. Please only use firmware updates that have been published on the Radioddity support pages for the Xiegu X6100. The display may look like this, for example:

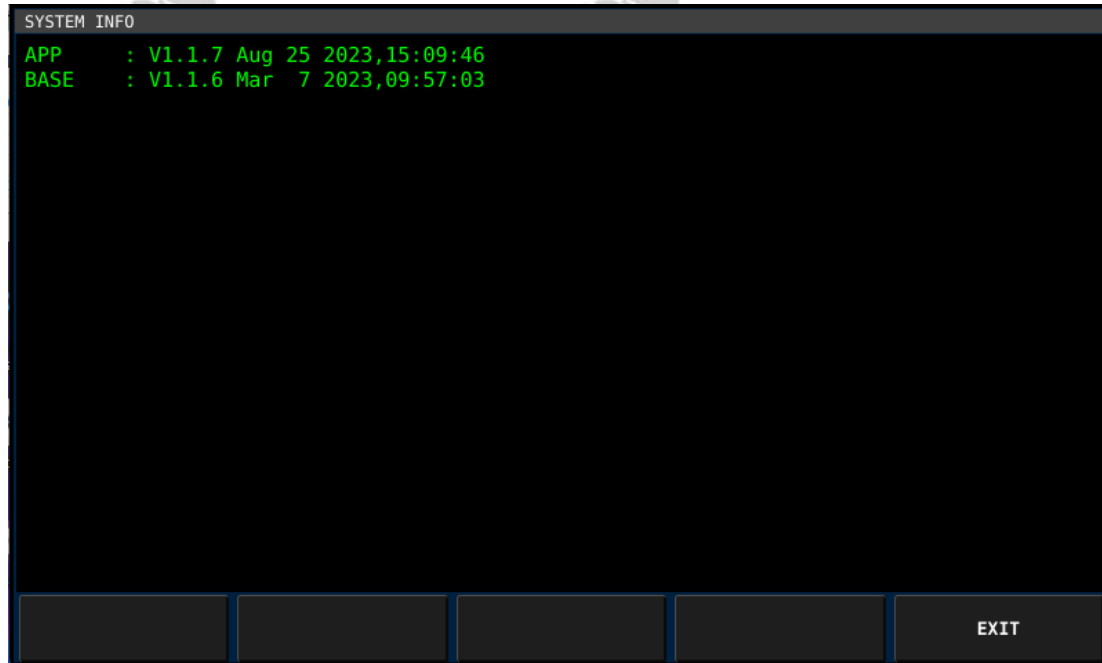

The softkey function is as follows:

Softkey	function
EXIT	Exit the submenu

10.1.4.3 FIRMWARE UPGRADE

This function will normally complete the procedure for updating the firmware of the Xiegu X6100 as described in detail in chapter 11 starting on page 73, which provides the file needed for this upgrade of the radio's operating software.

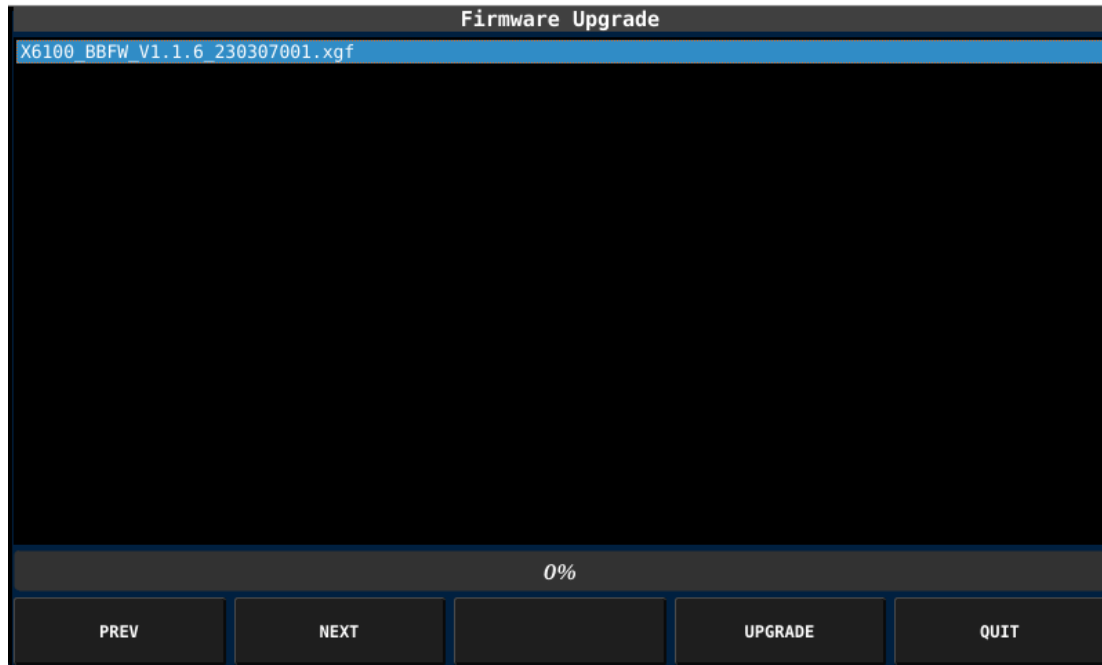

The softkey functions are as follows:

Softkey	function
PREV	To the previous firmware in the displayed list
NEXT	To the next firmware in the displayed list
UPGRADE	Select the currently selected firmware for the update process and start the update process immediately (there is no confirmation prompt!)
QUIT	Exit the submenu

Note:

Only update the firmware of the Xiegu X6100 if it is really necessary.

10.1.4.4 WLAN

To use the WLAN support of the Xiegu X6100, the WLAN must first be activated. To do this, first select the 'WIFI Switch' parameter and then activate it using the 'EDIT' softkey.

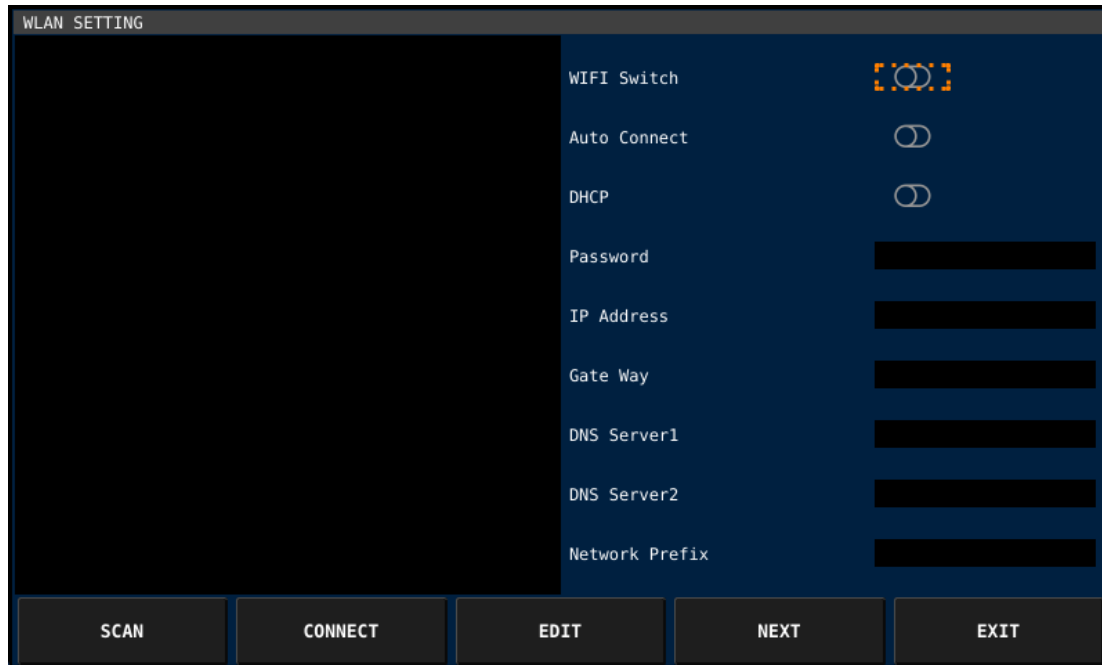

The softkeys function as follows:

Softkey	function
SCAN	Search for Wi-Fi/hotspots nearby (access points)
CONNECT / DISCONNECT	Establish / terminate connection with the Wi-Fi displayed in the left field
EDIT	Edit the parameter outlined in orange in the right-hand field
NEXT	Switch to the next parameter (is then displayed with an orange border)
EXIT	Exit the submenu

A selected parameter is surrounded by a dashed orange line for switch settings. A parameter value that is currently being edited, on the other hand, is surrounded by a dashed green line. You can change the value of the selected parameter with 'EDIT'. Use 'CLOSE' to save the changed values.

The individual parameters should be set as follows:

- **WIFI Switch** must be switched on for Wi-Fi support to be activated.
- Turn the multifunction knob to select the appropriate SSID from the list of available Wi-Fi networks shown on the left.
- **Auto Connect** should be turned on.
- Leave **DHCP** switched off (as DHCP is not working at the moment).
- Enter the **Password** for the selected WLAN network.
- Assign a free **IP address** to the Xiegu X6100 via the IP Address field.
- Enter the default gateway in **Gate Way**. This is usually the IP address of your home Internet router.
- You can leave **DNS Server1** at '8.8.8.8'. '8.8.8.8' is a DNS server from Google or enter your home router's IP address if it supports DNS (most do).
- You can leave **DNS Server2** at '8.2.2.2'. If required, you can specify another DNS server at this point.
- **Network Prefix** should normally be '24' (i.e., Class C network address structure) for a home network. So do not change this parameter unless you are in a special (commercial) network.

As soon as you have made all the settings, press the 'CONNECT' softkey to connect the Xiegu X6100 to your local Wi-Fi. After a few seconds, it will have logged into the local Wi-Fi.

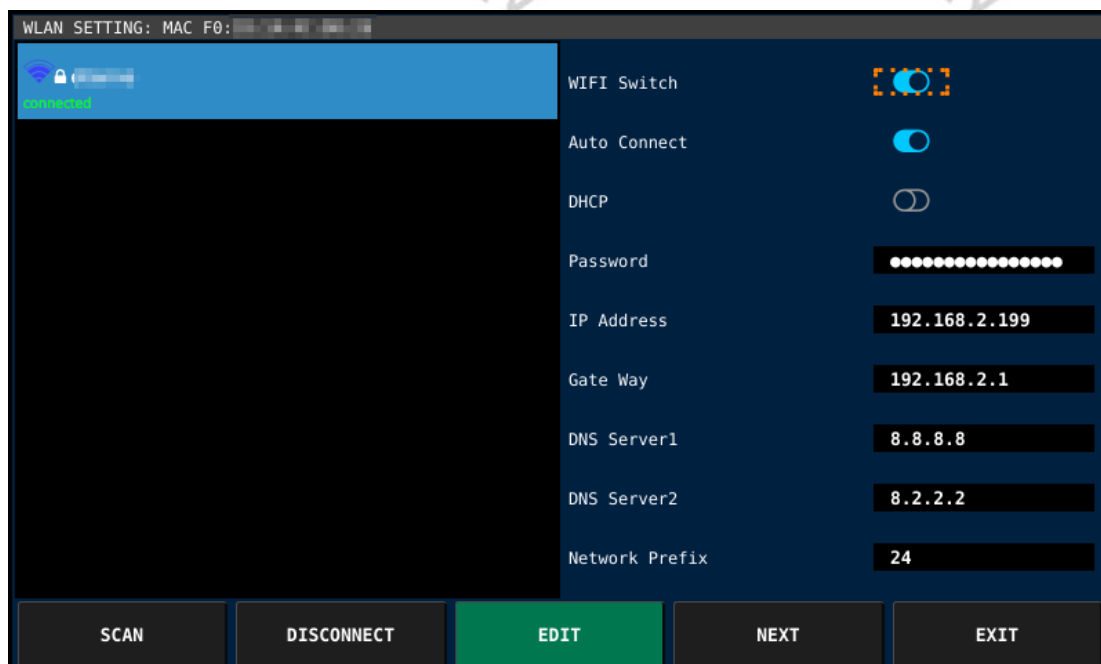

You can recognize this by the fact that 'connected' now appears in green below the Wi-Fi SSID. In addition, the labeling of the second softkey has changed from 'CONNECT' to 'DISCONNECT'.

This completes the WLAN configuration of the Xiegu X6100.

10.1.4.5 BLUETOOTH

To be able to use Bluetooth with the Xiegu X6100, the Bluetooth support of the Xiegu X6100 must first be activated. To do this, press the softkey labeled 'ON' in the Bluetooth submenu.

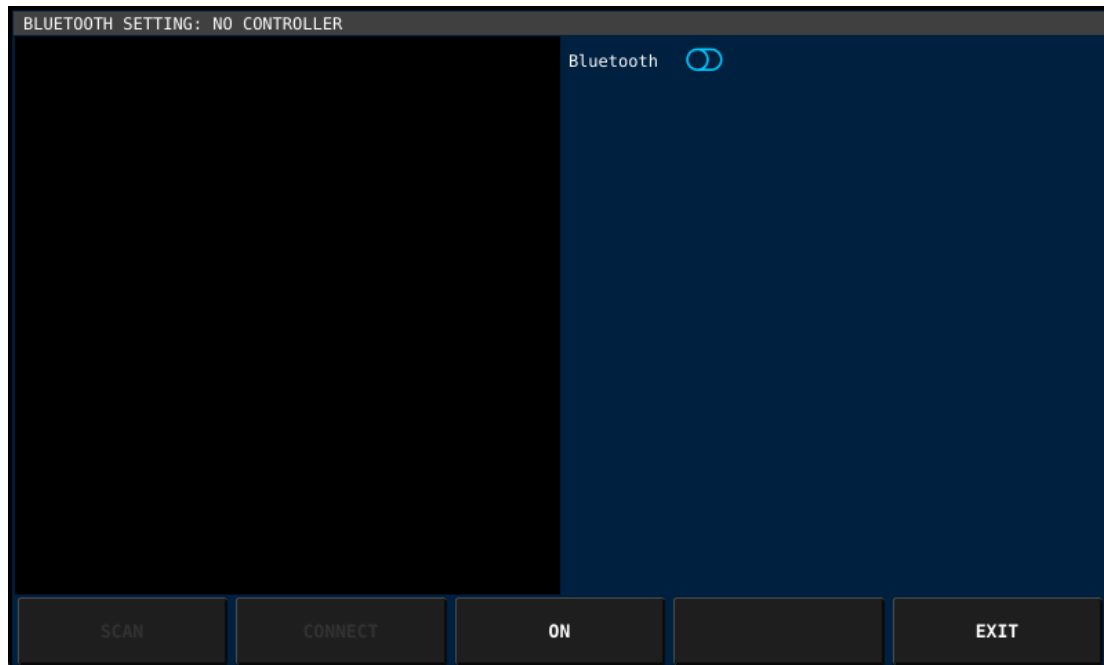

You can then search for neighboring Bluetooth devices by triggering the 'SCAN' function. The process initially takes about a minute. Future attempts will be much faster.

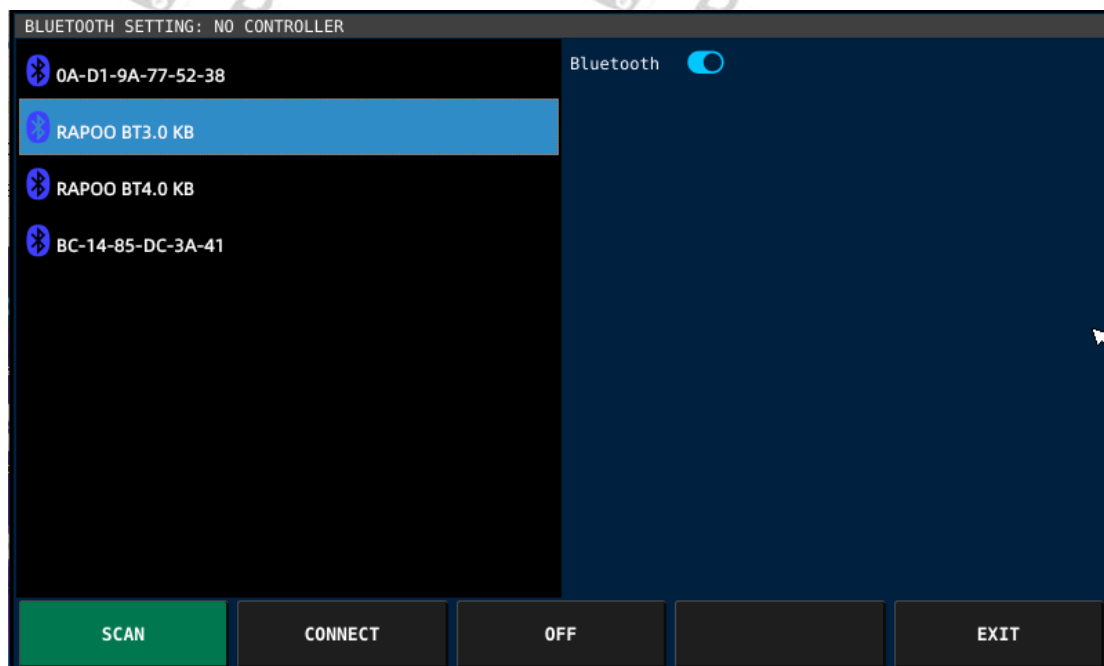

Now use the MFK rotary knob to select a device from the devices listed on the left-hand side and then confirm your selection by pressing the 'CONNECT' softkey.

For successful pairing between the Bluetooth device and the Xiegu X6100, the Bluetooth device must be in pairing mode.

The function of the softkeys are as follows:

Softkey	function
SCAN	Search for Bluetooth devices nearby
CONNECT / DISCONNECT	Establish / terminate connection with the Bluetooth device displayed in the left field
ON / OFF	Turning the Bluetooth function on / off
EXIT	Leave the submenu

Note: *At present only mouse & keyboard hardware via Bluetooth is supported. Although it is possible to see, pair and connect to an audio BT device (e.g., headset) there is no option to tell the X6100 to route its audio there or take audio (Mic) input from there.*

10.1.4.6 WFSERVER

Since firmware version v1.1.7 as of August 25th 2023 and baseband version V1.1.6 as of March 7th 2023, the Xiegu X6100 also supports wfview, a PC based remote control application. The activation of the wfserver in the X6100 and the required installation of the wfview PC application is described in detail in chapter 13 starting on page 83.

10.1.4.7 FACTORY RESET

Almost all settings of the Xiegu X6100 can be reset by selecting the 'FACTORY RESET' function.

As soon as you select the submenu, a security prompt appears and warns you that any personal settings or data will be lost during the reset process.

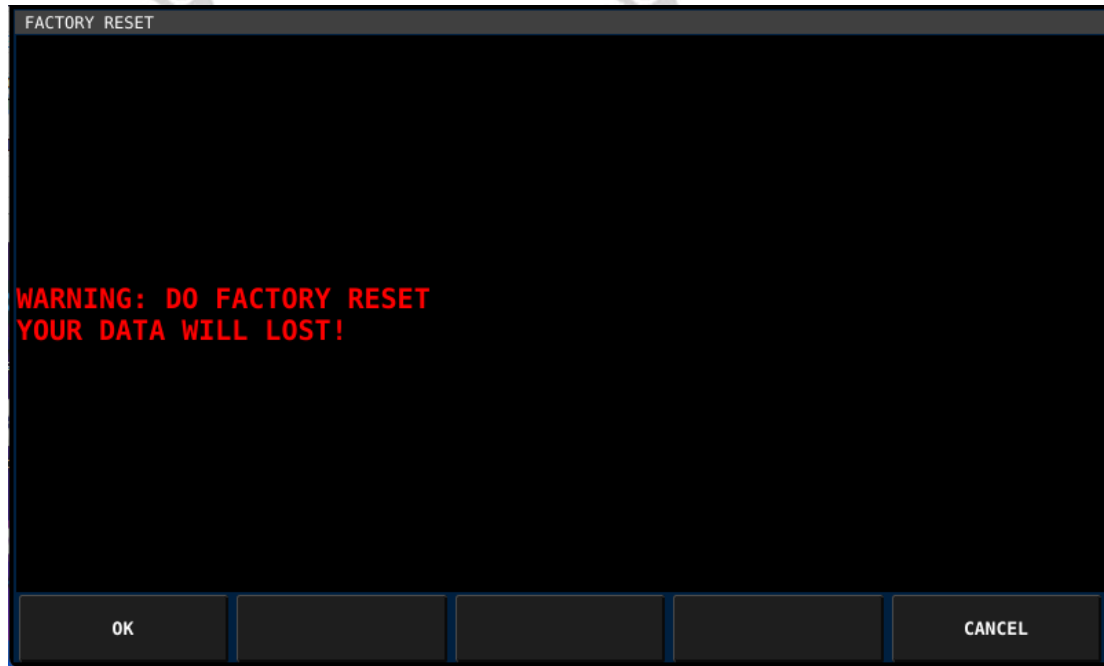

Confirm you wish to proceed by pressing the softkey labeled 'OK'. You will then be asked to press the softkey labeled 'OK' again.

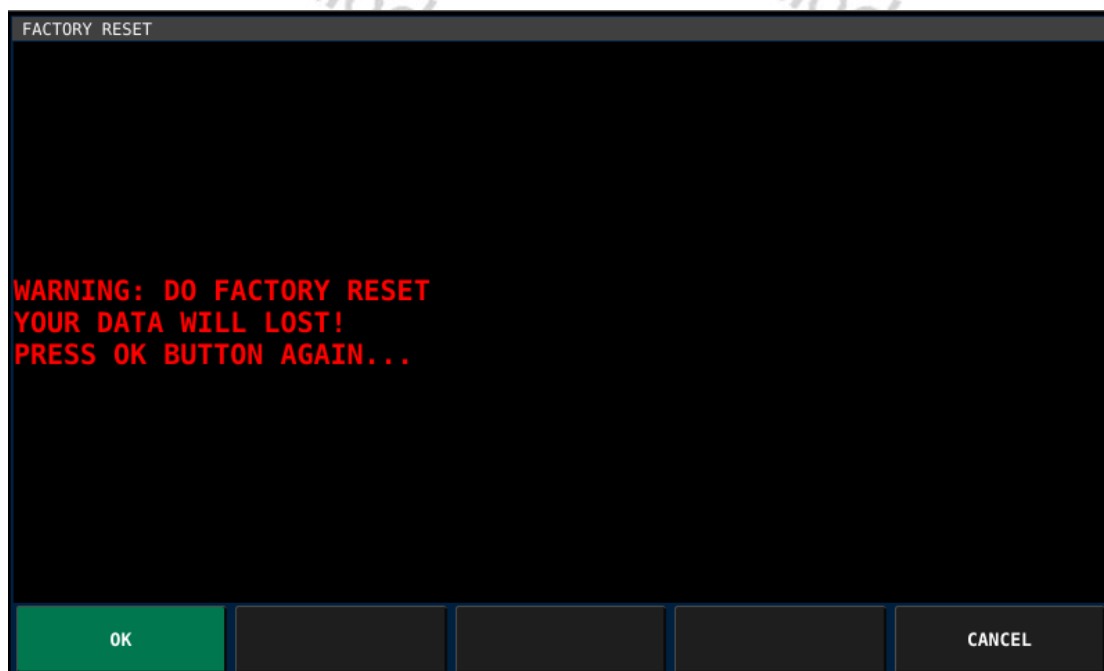

After a few seconds, the Xiegu X6100 switches off automatically and after a short wait, it automatically switches on again with all settings as they were when the radio left the factory.

10.1.5 MEMORY EDIT

The Xiegu X6100 allows you to permanently store up to 200 channels in the device. Briefly press the softkey labeled 'MEMORY EDIT' to call up the corresponding submenu. You can view the individual settings of each of the 200 memory locations and, if required, assign the currently selected VFO frequency to one of them.

If the currently selected memory location (indicated by the green dashed frame) is not yet occupied, you can use the 'SAVE VFO' softkey to save the current frequencies of VFO-A and VFO-B along with their respective operating modes to it.

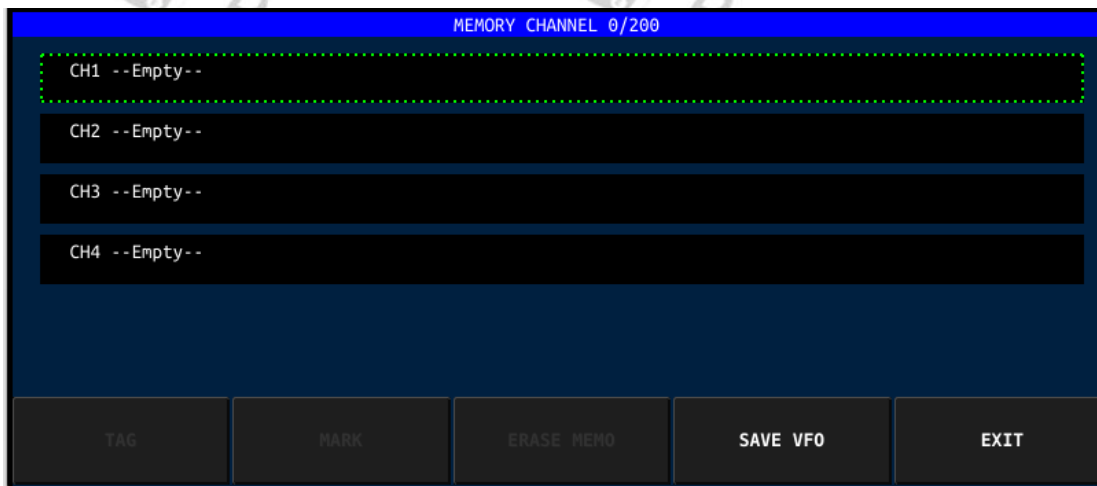

The function of the softkeys is as follows:

Softkey	function
TAG	Apply a name to the currently selected storage location.
MARK	Mark the current memory location. The symbol of a small house 🏠 is also displayed in front of the channel number.
ERASE MEMO	Delete the settings of the selected (marked) memory location.
SAVE VFO	Saves the current frequency, operating mode, etc. to an empty memory location. Only available if the selected memory location is not yet in use.
EXIT	Exit the submenu

10.1.5.1 TAG

Settings previously stored in a memory location can be given a name using the 'TAG' function. As soon as you press the softkey labeled 'TAG' after selecting the corresponding memory location, an on-screen keyboard is displayed.

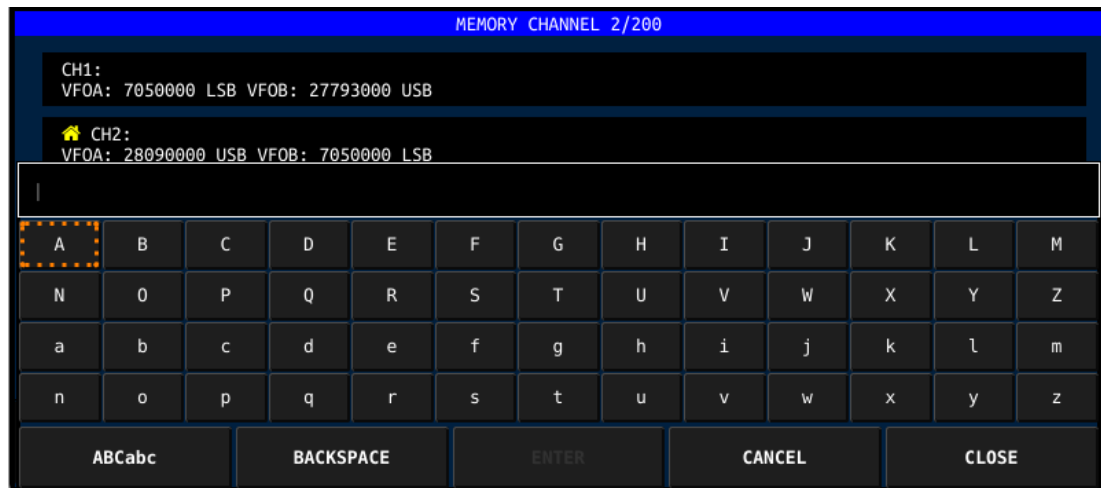

Now enter a name for this storage location. Labelling channels makes it much easier for you to select the correct storage location by name at a later date.

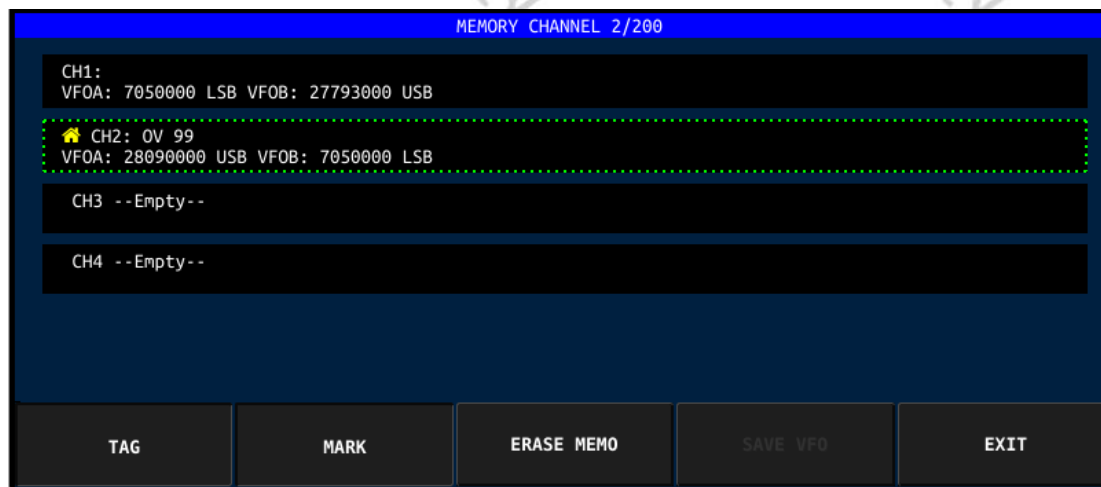

10.1.5.2 MARK

One of the memory locations occupied by settings can be specially marked with an additional house. To do this, first select the corresponding memory location and then press the softkey labeled 'MARK'.

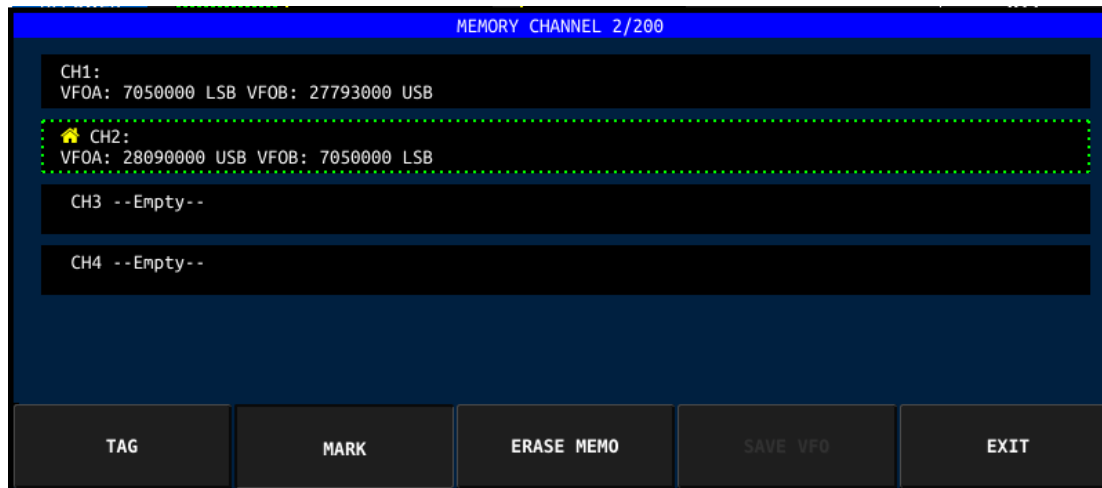

10.1.5.3 ERASE MEMO

If the settings of the currently selected (marked) memory location are no longer required, they can be deleted using the 'ERASE MEMO' function.



The free memory slot is then available again for new channels.

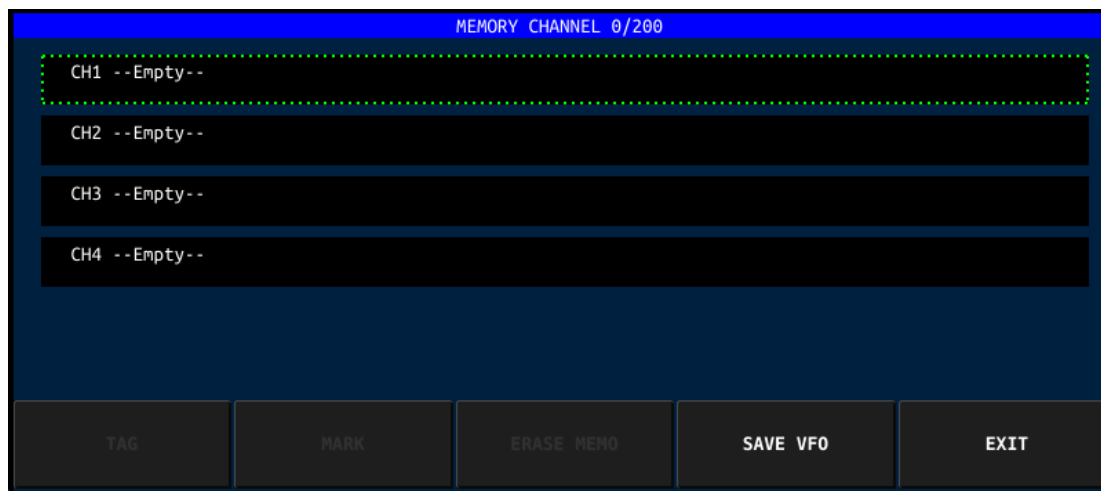

In practice, however, the available 200 memory locations should be sufficient.

10.1.5.4 SAVE VFO

The 'SAVE VFO' function is used to save the current frequency and operating mode in an empty channel. To avoid accidentally overwriting already occupied memory locations, this function is only available for empty memory locations. The new settings are immediately visible after saving.

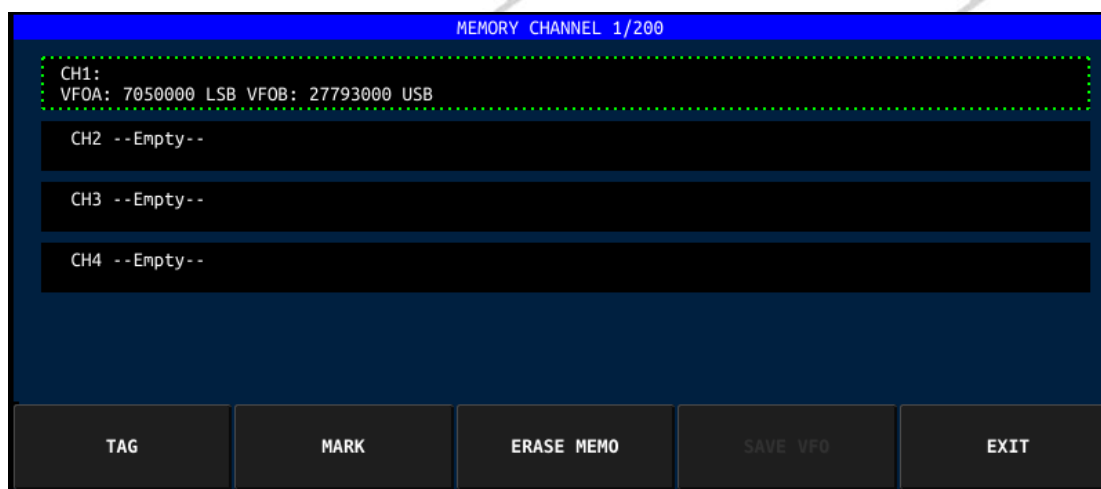

10.1.5.5 EXIT

Press the softkey labeled 'EXIT' to exit the submenu.

10.2 The APP function

The APP (Application) function currently contains 3 submenus, MODEM, SWR SCAN and VOICE CALL and can be called up by pressing the [APP] button.

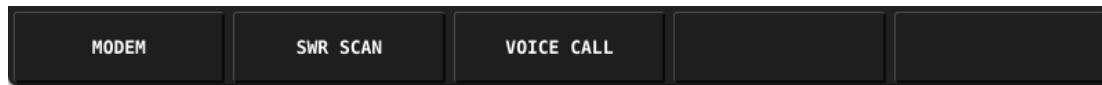

The function of the softkeys is as follows:

Softkey	function
MODEM	Settings for the built-in CW modem
SWR SCAN	Settings of the built-in standing wave scanner
VOICE CALL	Automatic transmission of a voice message

10.2.1 MODEM

The various modem settings for RTTY, CW and BPSK can be accessed via this submenu.

10.2.1.1 <1>/<2>

As the submenu contains more options than there are softkeys available, it has been split into two groups. Pressing the softkey labeled '< 1 >' or '< 2 >' switches between the two groups of softkeys.

10.2.1.2 MODE

The following operating modes are supported by the modem:

Mode	Operating mode
RTTY	Radio TeleTYpe using Baudot codes
CW	Morse telegraphy (continuous wave)
BPSK	Digital modulation method in which the state of a bit is determined by the phase position of the carrier frequency (binary phase shift keying)

Default: BPSK

10.2.1.3 FC/TONE

By default, the carrier signal/side tone is preset to a frequency of 1000 Hz Hz for BPSK & RTTY, 800 for CW. By turning the MFK rotary knob, the frequency can be freely selected in 1 Hz steps between 500 Hz and 2500 Hz.

Default: BPSK/RTTY 1000 Hz, CW 800Hz

10.2.1.4 RATE/SPEED

The coding speed can be selected in several stages depending on the selected operating mode by turning the MFK rotary knob.

Mode	Possible speeds
RTTY	45/45.45/50/56/75/100 bps
CW	5...50 WPM
BPSK	PSK31/PSK63/PSK125

Default: BPSK PSK31, RTTY 45.45 bps, CW 15WPM

10.2.1.5 RTTY SHIFT

This parameter is only available in RTTY operating mode and defines the frequency difference (shift) between the two tones for MARK and SPACE. As a rule, a frequency spacing of 170 Hz is used.

In RTTY, the closed loop signal is called 'Mark' and the open loop signal is called 'Space', and the frequency difference between Mark and Space is called the frequency spacing or shift frequency. A frequency spacing of 170Hz is usually used. However, possible values are 23, 85, 160, 170, 182, 200, 240, 350, 425 and 850 Hz.

To demodulate the RTTY signal, the two tones must be converted to pulse-point frequency, where '1' is the passband signal and '0' is the zero signal. By fine-tuning the frequency, you can hear that the tone of the zero and passband signal changes, but their frequency difference is always 170 Hz, at this time, the position of the center frequency is not important, the most important thing is the frequency difference.

Default: 170

10.2.1.6 AFC

Automatic Frequency Control can be switched ON and OFF with this function.

For the reception of digital modulated bandpass signals with carrier modulation, a quadrature demodulator is generally used for carrier demodulation to extract the zero IF signal. Due to the different frequency sources of the transmitting and receiving devices and the possible Doppler shift due to relative movements, frequency and phase deviations in the obtained zero IF signal are unavoidable and full carrier demodulation is not achieved. To achieve complete carrier demodulation, the local oscillations in the quadrature demodulator must be made to track the carrier frequency and instantaneous phase implicit in the received signal; this is called carrier tracking or AFC.

Default: OFF

10.2.1.7 SQL

A squelch can be activated for the modem via this parameter. The squelch level can be set between 0...100.

Default: 0 (off)

10.2.1.8 CLEAR

This function is used to delete the text of the signals previously decoded in the screen area above the softkeys.

10.2.1.9 Sending prepared text messages

If the [MSG] button is pressed when the modem submenu is active, it is possible to send one of the 5 stored texts (MSG1...5) using the selected modem mode (BPSK, RTTY or CW).

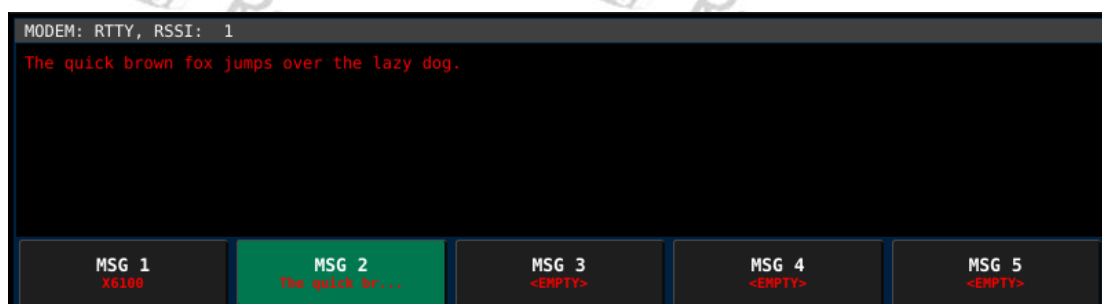

10.2.1.10 EXIT

Press the softkey labeled 'EXIT' to exit the submenu.

10.2.2 SWR SCAN

To graphically display the standing wave ratio of the connected antenna over a frequency range limited by the 'SPAN' parameter, press the softkey labeled 'SWR SCAN'. The transmitter of the Xiegu X6100 is then activated and the frequency range (SPAN) around the previously set frequency of the VFO is scanned at the set speed (SPEED) until the softkey labeled 'EXIT' is pressed. Turn off the ATU before using this feature otherwise it will not measure the SWR of the antenna rather of the ATU input.

10.2.2.1 SPAN

The underlying scan bandwidth for the SWR scan is defined with this parameter. Possible multiplier values for the step-by-step multiplication of the scan bandwidth are: 1000, 2000, 5000, 10000. kHz. The values are switched through by pressing the softkey labeled 'SPAN'.

Default: 1000 (1 MHz)

10.2.2.2 SPEED

The speed of the SWR scan can be set between 1...5. The lower the speed selected, the more precise the resulting graph of the result.

Default: 1

10.2.2.3 EXIT

Press the softkey labeled 'EXIT' to exit the submenu.

10.2.3 VOICE CALL

Recurring transmissions such as a 'CQ call' can be permanently stored on the Xiegu X6100 as a voice message. Five different messages can be stored.

10.2.3.1 VOICE MSG 1...5

By pressing one of the softkeys labeled 'VOICE MSG', the corresponding pre-recorded voice message (see MSG Function in section 10.4 starting on page 65) is selected and transmitted on the current frequency. Pressing the [APP] button takes you back to the APP function menu.

10.3 The KEY function

All parameters associated with the use of a Morse key or an automatic character transmitter can be set via the KEY function. These include Type of connected Morse key, speed of character output, IAMBIC characteristics, tone frequency and tone level as well as QSK time, DIT/DA ratio and the built-in CW trainer.

<1>KEY TYPE AUTO-RIGHT	KEY SPEED 10 WPM	IAMBIC IAMBIC-A	TONE 800 Hz	TONE LEVEL 10
---------------------------	---------------------	--------------------	----------------	------------------

As there are more parameters (8) than softkeys (5) available, you can switch between the two softkey assignments by pressing the [KEY] button again.

<2>QSK TIME 100 ms	DI/DA RATIO 3.0	CW TRAINER OFF		
-----------------------	--------------------	-------------------	--	--

10.3.1 KEY TYPE

Both manual character transmitters (classic Morse key) and automatic character transmitters are supported.

KEY TYPE	Type of character generator
MANUAL	Classic Morse key
AUTO-LEFT	Operating the automatic character generator with the left hand (thumb: DA/dash, index finger: DIT/dot)
AUTO-RIGHT	Operating the automatic character generator with the right hand (thumb: DA/dash, index finger: DIT/dot)

Default: MANUAL

10.3.2 KEY SPEED

This parameter is only relevant for automatic character generators and determines the speed at which characters are output. Possible values are 5...50 WPM.

Default: 15 WPM

10.3.3 IAMBIC

The Xiegu X6100 supports both IAMBIC-A and IAMBIC-B. This requires a so-called paddle in which one of the two wings is responsible for the delivery of dahs/strokes and the other for the delivery of DITs/dots.

Default: IAMBIC-B

10.3.4 TONE

This parameter is used to set the frequency of the side tone between 400 Hz and 1200 Hz in steps of 10 Hz.

Default: 800 Hz

10.3.5 TONE LEVEL

The output level of the side tone can be set between 0 and 10.

Default: 10

10.3.6 QSK TIME

Possible QSK times are 0...1000 ms in steps of 10 ms.

Default: 100 ms.

10.3.7 DI/DA RATIO

The ratio between DIT/dot and DA/dash can be freely selected in steps of 0.1 between 2.5 and 4.5.

Default: 3.0

10.3.8 CW TRAINER

The CW trainer is switched ON or OFF here.

Default: OFF

10.4 The MSG function

5 text messages and 5 voice messages can be permanently stored on the Xiegu X6100. Pressing the [MSG] button again switches between text and voice messages. When voice messages are selected, the word 'VOICE' appears in red below the corresponding softkey labeled MSG 1...5.

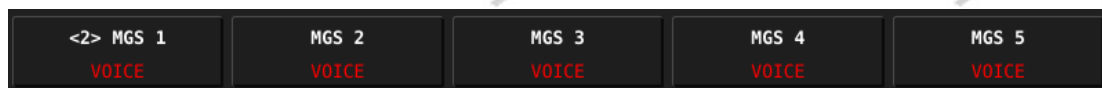

For selected text messages, the first 8 characters of the stored text appear in red below the corresponding softkey labeled MSG 1...5.



10.4.1 MSG 1...5 (Text)

A text that has already been saved is shown on the LCD as soon as the corresponding softkey is pressed.

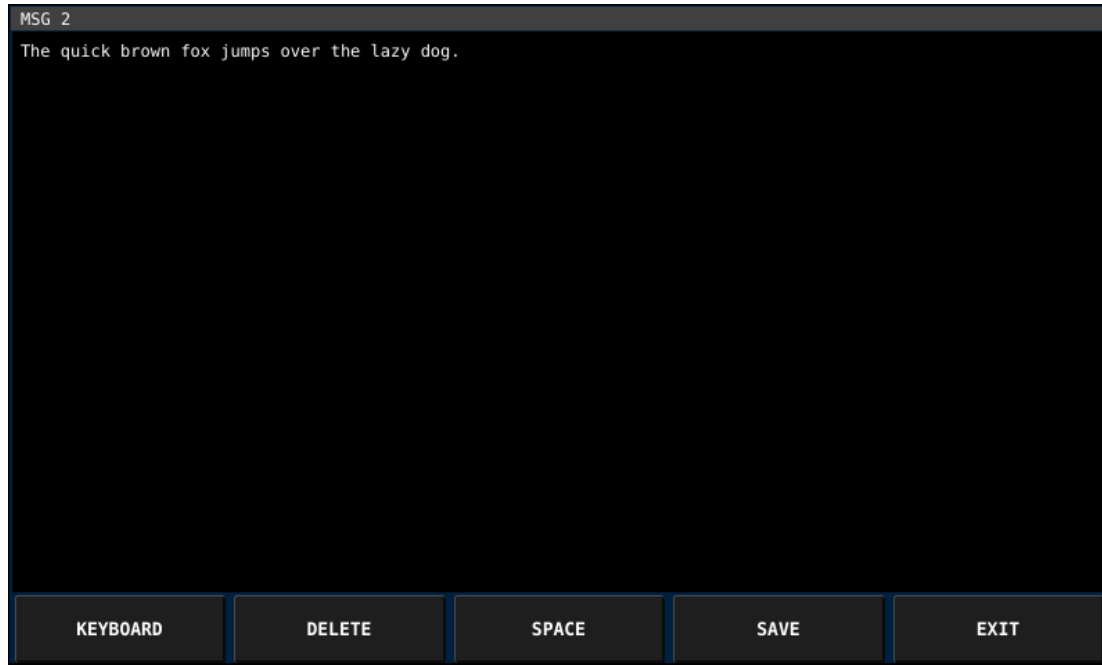

The following editing options are then available via the softkeys:

Softkey	function
KEYBOARD	Show the on-screen keyboard
DELETE	Delete the character to the left of the cursor
SPACE	Inserting a space character
SAVE	Saving the edited text
EXIT	Exit the submenu

After activating the on-screen keyboard, any letters, numbers and special characters can be entered. Please note that, depending on the operating mode set as the modem mode, lower-case letters may be automatically converted to upper-case letters or special characters may not be transmitted when the entered text is sent later as while BPSK supports most characters RTTY and CW have a more restricted alphabet.

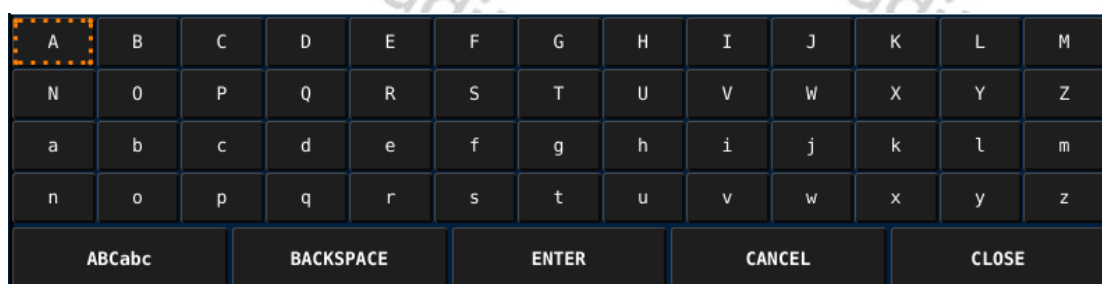

When the on-screen keyboard is selected, the following options are available via the softkeys:

Softkey	function
ABCabc	It is currently possible to enter letters. Pressing the softkey switches to entering numbers and special characters.
123,.,?	It is currently possible to enter numbers and special characters. Pressing the softkey switches to entering numbers (referred to here as IPv4).
IPv4	It is currently possible to enter numbers (referred to here as IPv4). Pressing the softkey switches to entering letters.
BACKSPACE	Delete the character to the left of the cursor.
ENTER	Inserts a new line.
CANCEL	Cancels the input.
CLOSE	Closes the displayed on-screen keyboard

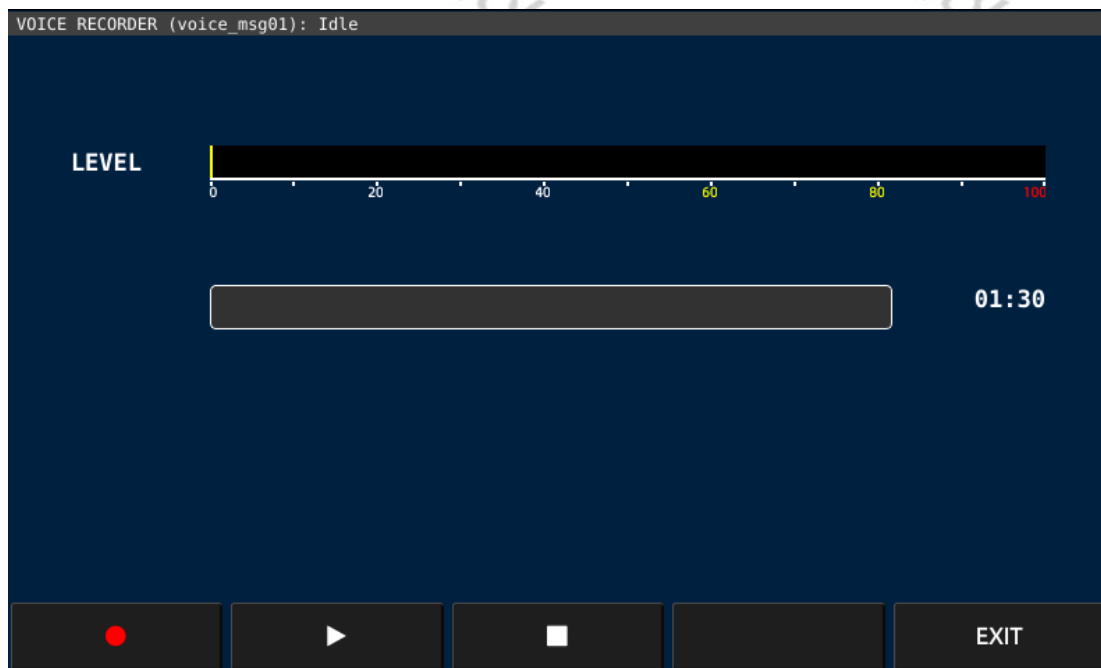

10.4.2 MSG 1...5 (Voice)

The built-in voice recorder appears as soon as one of the softkeys for MSG (VOICE!) 1...5 is pressed.







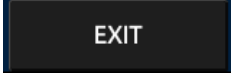

Note: Audio recording is performed using the hand-held microphone, the built in microphone does not work with the recorder. (do not press the PTT button).

The voice recorder can now be operated using the softkeys:

Softkey	function
	Start recording
	Start playback
	Stop recording/playback
	Exit the submenu

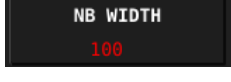
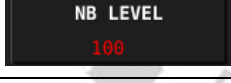
10.5 The DFN function

The Xiegu X6100 has digital filters for suppressing audio interference. Briefly press the [DFN] button to call up the corresponding submenu. You can now change the parameters described below. The assignment of the softkeys is displayed as usual in the lower area of the LCD.

Softkey	function
	Switch noise reduction on/off
	Set the level of noise reduction
	Switch noise blanking of interfering pulses on/off
	Bandwidth of a pulse
	Level of suppression
	Switch digital noise filter (DNF) on/off
	Middle audio frequency of the DNF
	Bandwidth of the DNF

As there are more parameters (8) than softkeys (5) available, you can switch between the two softkey assignments by pressing the [DFN] button again.

10.5.1 NR

This parameter can be used to switch the noise reduction function ON or OFF. When noise reduction is switched on (indicated by the **NR** in the 'Status1' field), the otherwise audible background noise is significantly lower.



Default: OFF

10.5.2 NR DEPTH

This parameter can be used to set the noise suppression depth (noise suppression level). The higher the set value, the stronger the resulting noise suppression. The value can be set in steps of 1 from 0...60.

Default: 0

10.5.3 NB

This parameter can be used to switch noise blanking of short audio pulses On) and off. The status of NB is also displayed in the 'Status 1' field.



Default: OFF

10.5.4 NB WIDTH

The pulse bandwidth relevant for the aforementioned pulse suppression is defined with this parameter and can be set between 0...100 Hz in steps of 1.

Default: 10

10.5.5 NB LEVEL

The pulse depth (suppression level) can be set with this parameter in the range 0...100.

Default: 10

10.5.6 DNF

DNF (Digital Noise Filter) refers to the digital noise filter contained in the Xiegu X6100. It can be switched on and off with this parameter. The status of DNF is also displayed in the 'Status 1' field.



Default: OFF

10.5.7 DNF CENTER

The center frequency of the digital noise filter can be set between 100...3000 Hz in steps of 10.

Default: 1000



10.5.8 DNF WIDTH



The bandwidth of the digital noise filter can be set in 1 Hz steps in the range 10...100 Hz.

Default: 50

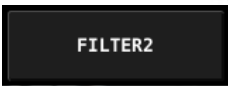
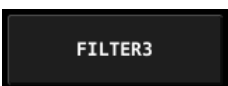
10.6 The DFL function

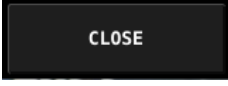
The Xiegu X6100 has 3 adjustable audio filters. Briefly press the [DFL] button to call up the corresponding submenu. You can now change the parameters described below. The assignment of the softkeys is displayed as usual in the lower area of the LCD.

Softkey	function
	Selection of filter 1
	Selection of filter 2
	Selection of filter 3
	Reset current filter to default values
	Exit the submenu

Each of these filters has a **low-pass filter** shown in **blue** and a **high-pass filter** shown in **red**. In combination, each filter thus represents a bandpass. The current bandwidth of the bandpass  is also displayed, as is the shift  in relation to the center frequency of 1500 Hz.



Switching between the low-pass filter shown in blue and the high-pass filter shown in red is done by pressing the MFK rotary knob.



10.6.1 FILTER1...3

On delivery, the 3 filters differ in their upper and lower cut-off frequencies and the resulting bandwidth.

Filter	from	to	Bandwidth
1	50 Hz	2950 Hz	2900 Hz
2	300 Hz	2700 Hz	2400 Hz
3	600 Hz	2400 Hz	1800 Hz

10.6.2 DEFAULT

Filters changed by the user are also marked with an '*'. Pressing the softkey labeled 'DEFAULT' reassigns the default settings to the currently selected filter.

10.6.3 CLOSE

Press the softkey labeled 'CLOSE' to exit the submenu.

11 Updating the Xiegu X6100 firmware

The Xiegu X6100 firmware is normally updated in three steps:

Step 1: Prepare microSD/flash memory card

First, prepare a microSD/flash memory card that can be used to upgrade the Xiegu X6100 operating system.

Step 2: Update of the Xiegu X6100 operating system (APP)

Update the application software (APP) using the prepared microSD/flash memory card.

Step 3: Update of the baseband firmware of the Xiegu X6100 (BASE)

Then use the updated system to update the baseband firmware (BASE).

Note: *The Xiegu X6100 must be connected to a stable 13.8V power supply during the entire update process in order to update the firmware.*

11.1 Preparing the microSD/flash memory card

You will need:

1. A microSD/flash memory card with at least 4 GB capacity
2. A device to read/write a microSD/flash memory card (if necessary with an adapter if the device is intended for SD sized memory cards)
3. A PC with Windows (7/10/11) operating system
4. A program to write to microSD/flash memory cards. On the following pages we use 'Rufus' for this purpose. You can get Rufus at the following URL: <https://rufus.ie/>

11.1.1 Writing the Xiegu X6100 firmware to the microSD/flash card

1. First unpack the update archive into a directory of your choice on your PC.

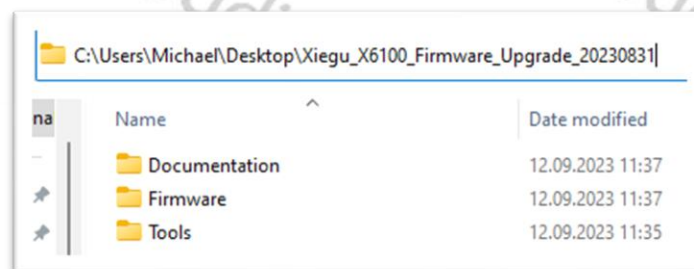

2. Insert an empty microSD/flash memory card (with adapter if needed) into the slot of your PC's read/write device.
3. Then start the program 'Rufus' by double-clicking on the corresponding exe file (you will usually find this in the 'Tools' subdirectory of the update archive).

You may first have to confirm a security prompt from your operating system with 'Yes'.

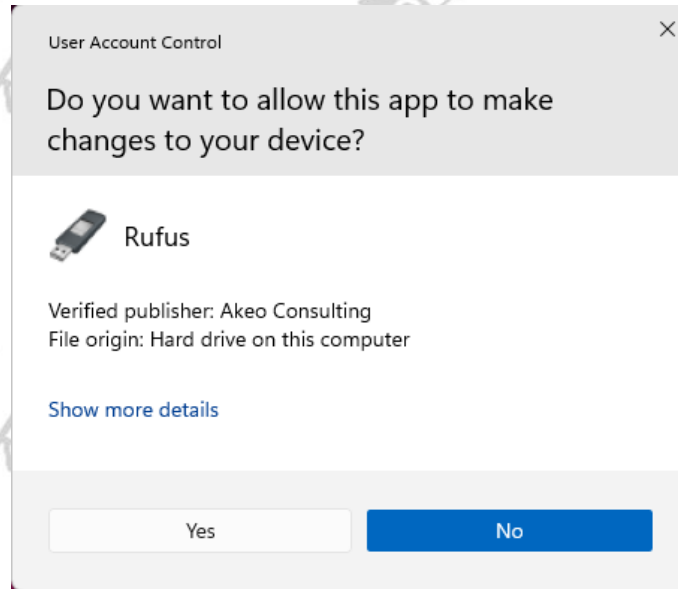

4. Next you will see the user interface of the 'Rufus' program.

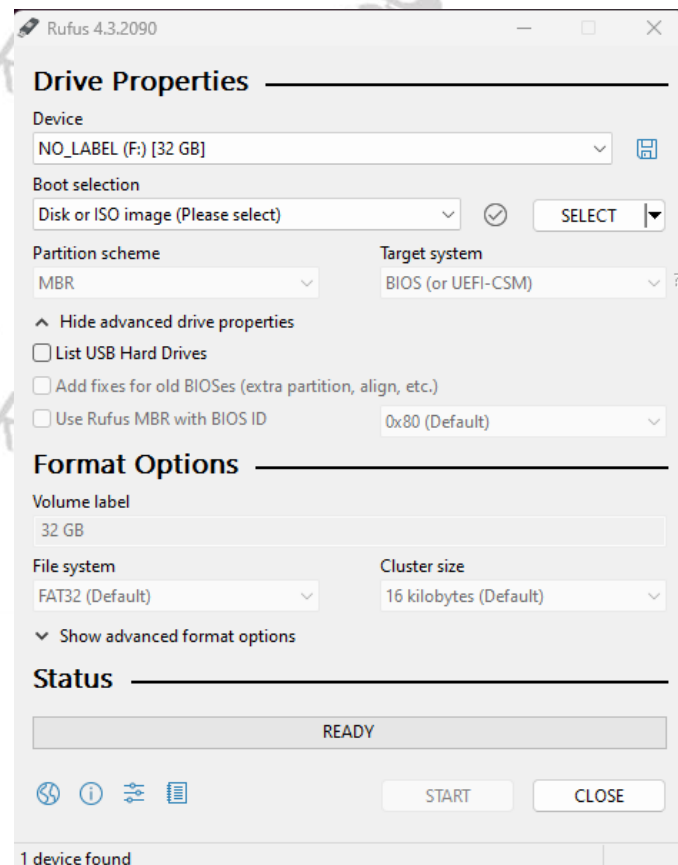

5. First check that the inserted microSD/flash card has also been recognized by the operating system.

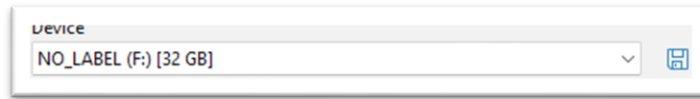

6. Also check whether the correct start type has been selected.

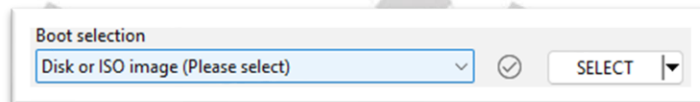

7. Next click on the **SELECT** button using the left mouse button and navigate to the directory in which you previously unpacked the update archive and there to the corresponding subdirectory of the firmware image file.

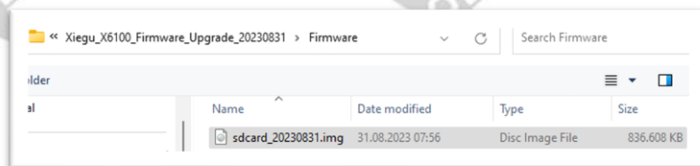

8. Click on the firmware image file and then select 'Open'
9. The file name of the firmware file is now displayed under 'Boot selection'.

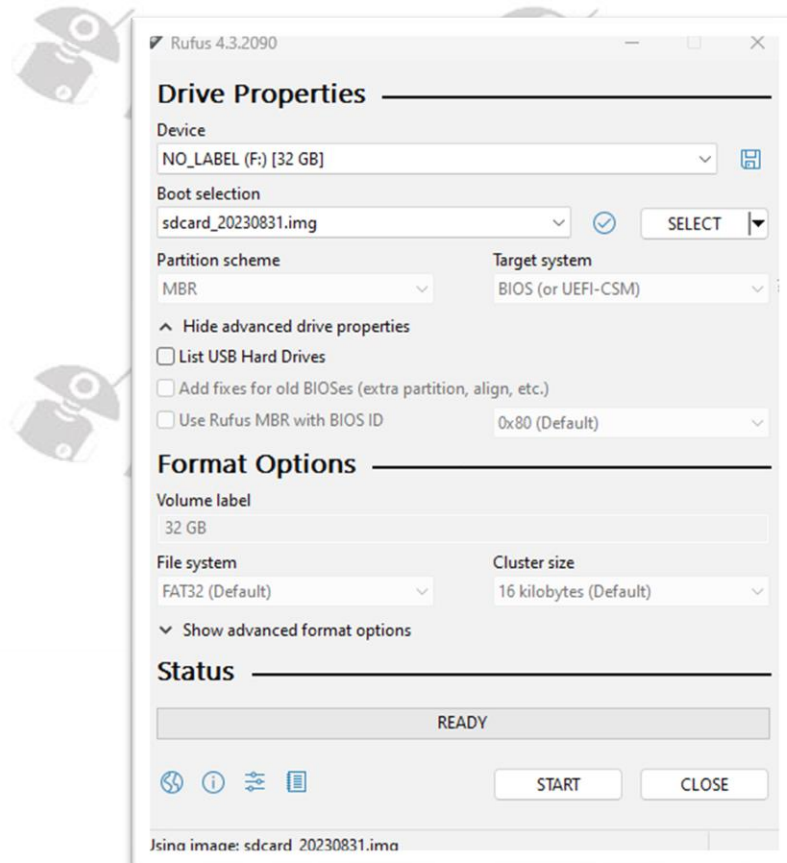

- Now click on the button to start the process of writing to the microSD/flash memory card.
- A security prompt appears first. This must be acknowledged by clicking on .

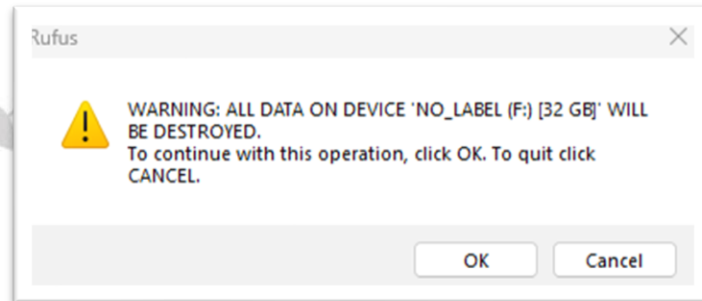

- The selected firmware is now written to the microSD memory card. The progress is displayed via a corresponding status bar.

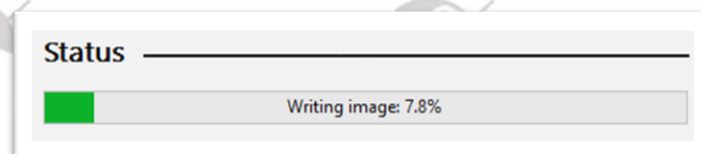

- As soon as the process has been successfully completed, the status appears. You can now exit the program by clicking on .
- Before you remove the memory card from the PC, click on in the status bar of your operating system and then select the corresponding USB drive of the microSD/flash memory and click on 'Eject'.

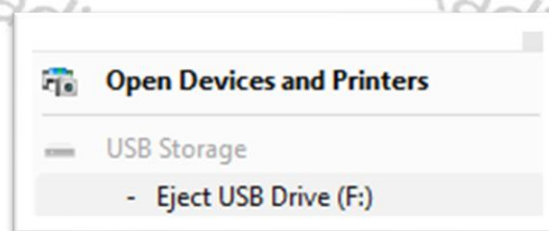

- The microSD/flash memory card may only be removed when you are prompted to do so.

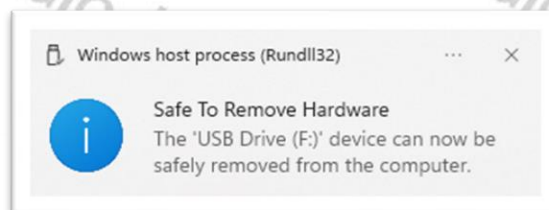

Note: Never remove the microSD/flash memory card from the PC without first 'ejecting' it.

11.2 Updating the Xiegu X6100 operating system (APP)

Make sure that the Xiegu X6100 is completely switched off for at least 30 seconds before inserting the microSD/flash memory card you have just prepared into the corresponding slot on the right-hand side of the Xiegu X6100. The 8 contact fingers of the microSD/flash memory card must point towards the LCD display.

The slot for the microSD/flash memory card has a mechanism similar to a ballpoint pen. If you carefully push the microSD/flash memory card in as far as it will go, it will then come out again by about 3 mm. This is the condition required for the microSD/flash memory card to be read by the Xiegu X6100. However, if you push the microSD/flash memory card in again as far as it will go, the microSD/flash memory card will come out 1 cm and you can then simply remove it again,

1. Insert the microSD/flash memory card into the microSD/flash slot on the right-hand side of the Xiegu X6100.
2. switch on the Xiegu X6100 using the power button .

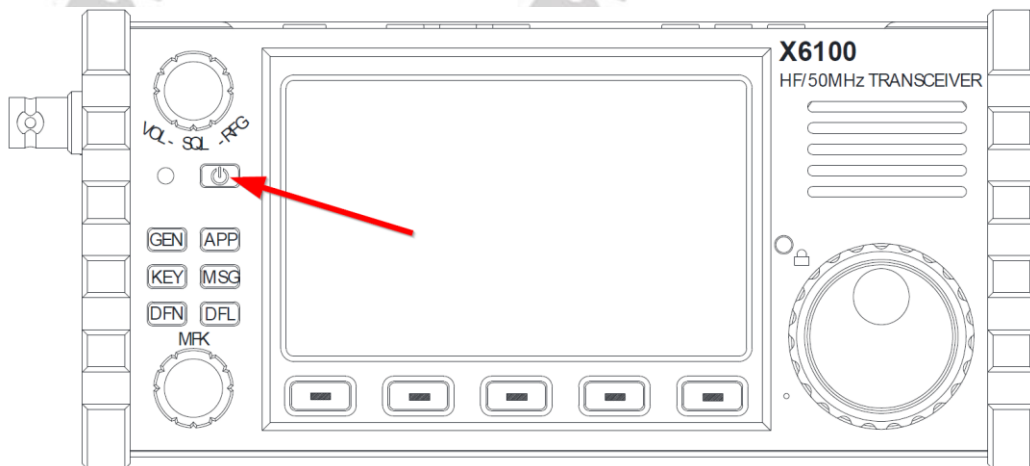

3. The operating system (APP) updates itself automatically after the radio is switched on without the need for manual intervention. After about 2 minutes, the update process is completed and the shutdown message prompt appears on the screen, after which the Xiegu X6100 shuts down automatically.
4. The microSD/flash memory card should now be removed. To do this, press the microSD/flash memory card once more as far in as it will go so that it bounces back and sticks out about 1 cm. You can now remove the microSD/flash memory card.
5. The update of the (APP) operating system is now complete.

Note: Please do not forget to remove the microSD memory card from the Xiegu X6100 after updating the operating system. Otherwise, the update process will run again the next time you start the Xiegu X6100.

11.3 Updating the baseband firmware of the Xiegu X6100 (BASE)

After updating the operating system (APP), the so-called baseband firmware (BASE) must now be updated.

Note: The Xiegu X6100 must be connected to a stable 13.8V power supply during the entire update process in order to update the firmware.

1. First switch on the Xiegu X6100 as usual using the power button .



2. Then press the following buttons in succession: [GEN] → SYSTEM SETTING to access the system settings menu.

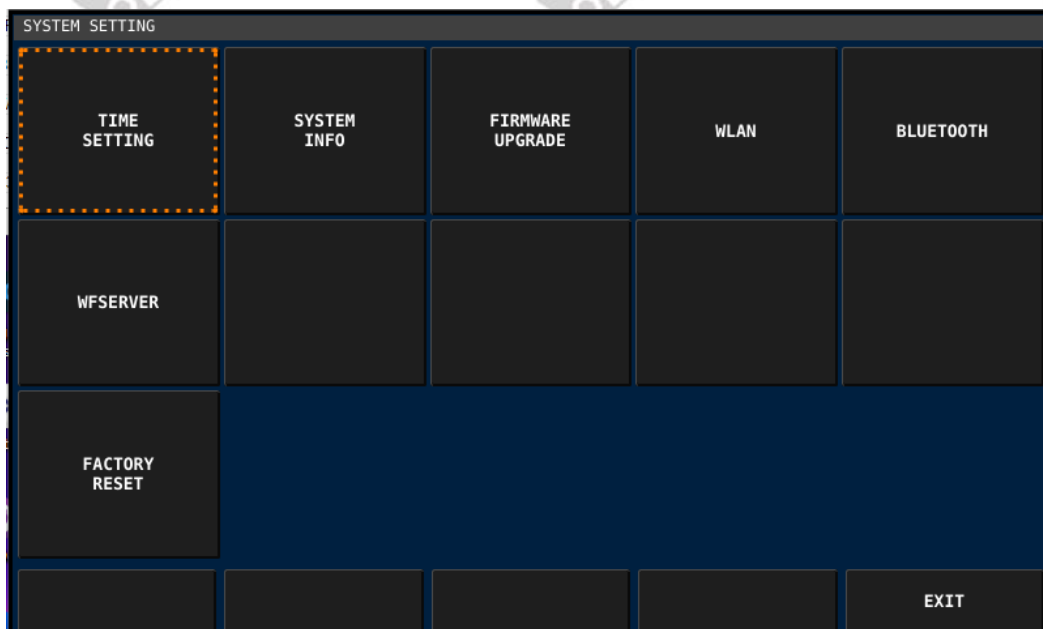

- Now select 'FIRMWARE UPGRADE' using the MFK rotary knob (bottom left next to the LCD) and confirm your selection by briefly pressing the MFK rotary knob.

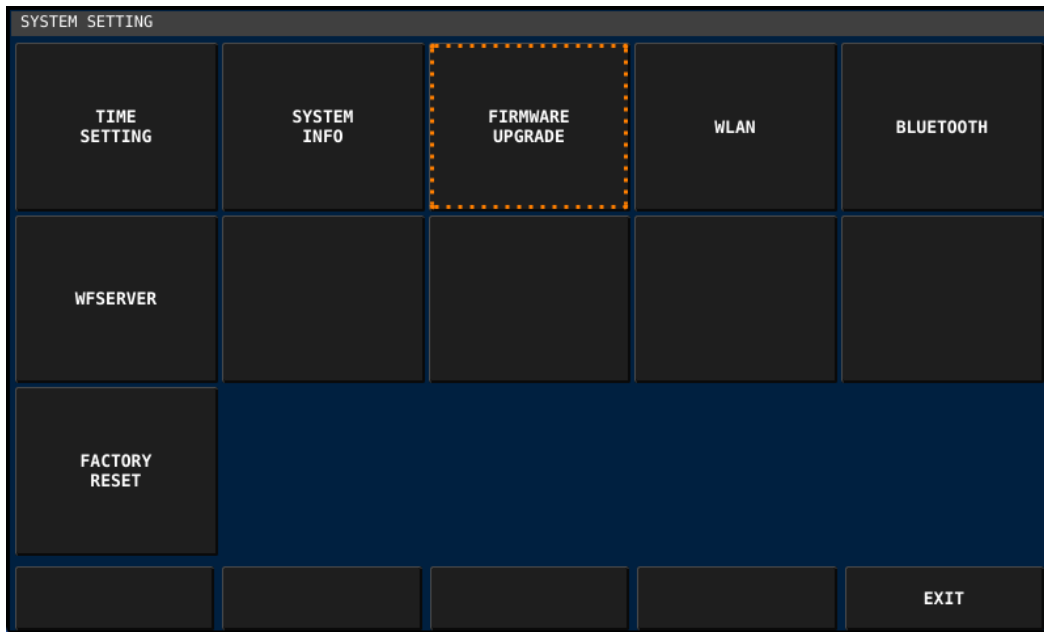

- Now a list of possible baseband firmware versions appears under the heading 'Firmware upgrade'. As a rule, however, there will only be one version. Otherwise, you can select the desired version from a list by pressing the 'PREV' and 'NEXT' softkeys.

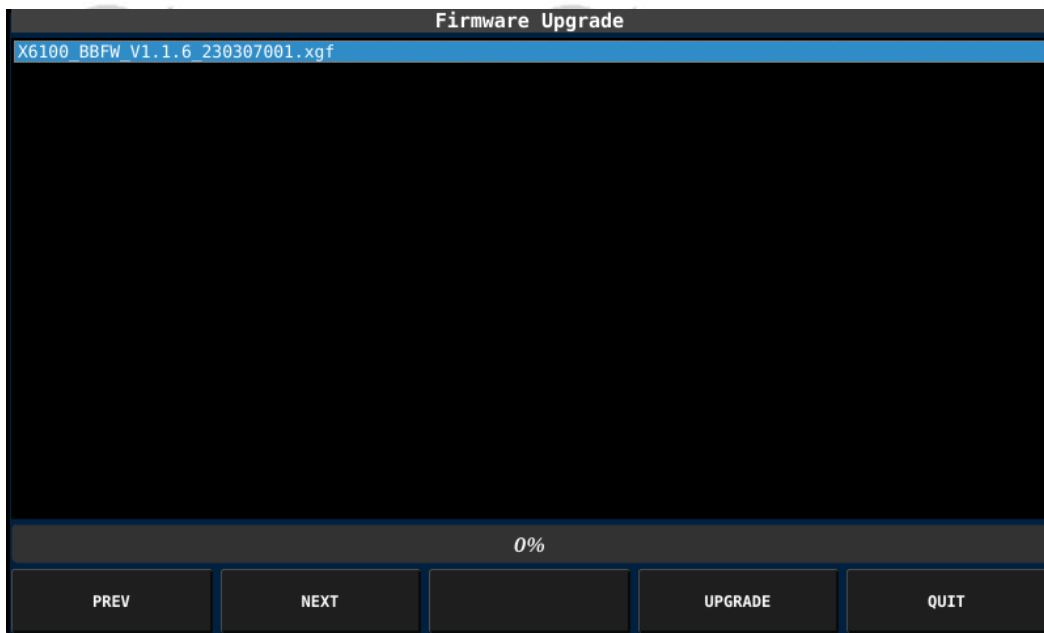

- Confirm your selection by pressing the softkey labeled 'UPGRADE'.

6. Within a few seconds, the following will appear in the title bar one after the other
 - Firmware Upgrade: Erasing Flash
 - Firmware Upgrade: Writing Flash
 - Firmware Upgrade: Done
7. Press the softkey labeled 'QUIT' after completing the update process to exit the submenu again.
8. Now switch off the Xiegu X6100 using the power button  and then switch it on again.

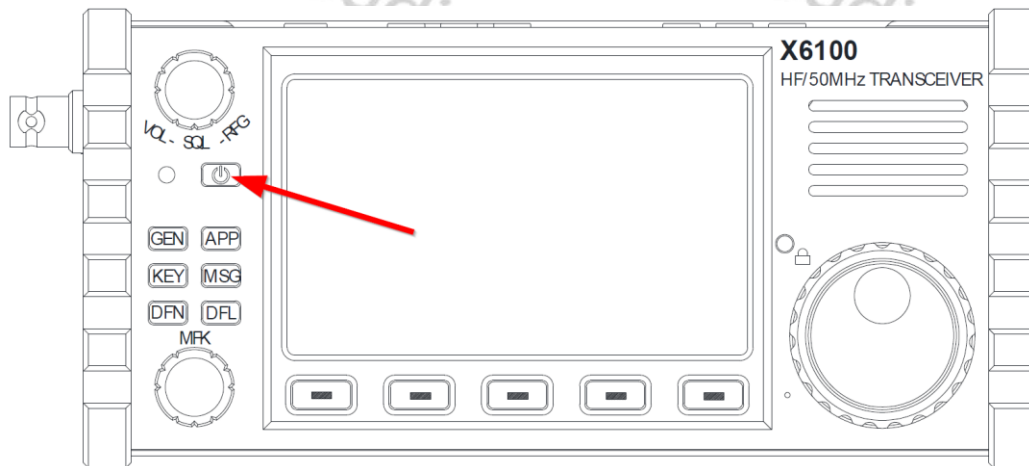

9. To check whether the baseband firmware update was successful, press the following buttons in succession [GEN] → SYSTEM SETTING to access the system settings menu.
10. Now select the 'SYSTEM INFO' item using the MFK rotary control (bottom left of the LCD) and confirm your selection by briefly pressing the MFK rotary control.

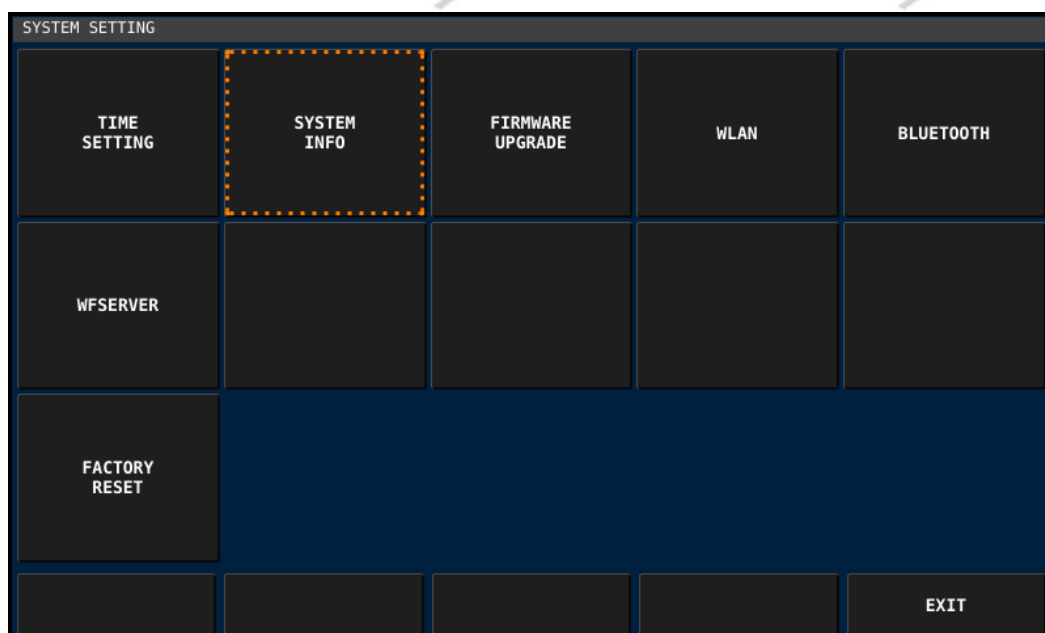

11. The LCD now shows both, the version of the operating system (APP) and the version of the baseband firmware (BASE).

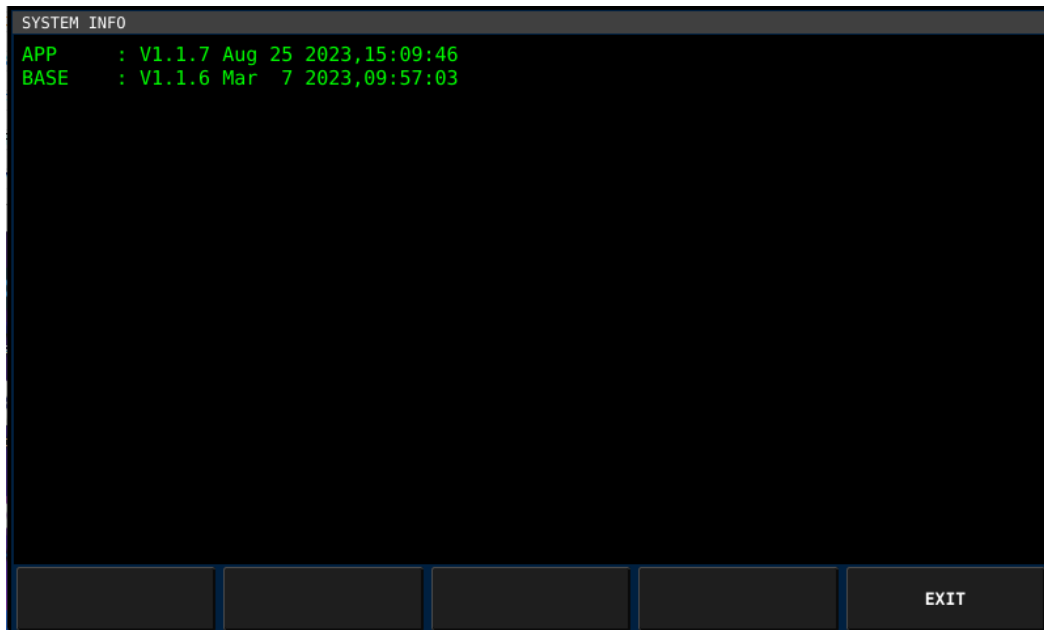

This completes the update process.

For older firmware versions of the Xiegu X6100, please visit our support area at <https://radioddity.com/pages/xiegu-download>

12 Firmware release notes

The following table lists the details that have been changed with new versions of the Xiegu X6100 firmware. Generally previous updates are included in the latest version.

Note: *Never update your radio if it is not really necessary, or in other words: **'Don't fix it if it's not broken'**! This cannot be emphasized often enough. To update the Xiegu X6100, only use the firmware that you can find on our support pages. Before carrying out an update, make sure that the firmware is still available for download on our support page. All firmware updates for the Xiegu X6100 are supplied with 'Release Notes'.*

Please carefully read the 'Release Notes' and all documents contained in the firmware archives!

12.1 Firmware as of August 31st 2023

Version	Changes	Released
APP: V1.1.7 Aug 25 2023,15:09:46 BASE: V1.1.6 Mar 7 2023,09:57:03	<ul style="list-style-type: none"> • WFSERVER added to Xiegu X6100 • CI-V CAT mode 'ECHO' made available 	2023/08/31

13 Use of wfview

The Xiegu X6100 must have at least operating system version V1.1.7 dated August 25th 2023 and baseband firmware version V1.1.6 dated March 7th 2023 in order to use the wfview remote control feature.

13.1 Preparation

1. First install the wfview application on your PC.
2. Then connect the Xiegu X6100 to your home network via Wi-Fi (wireless) or using a USB-LAN adapter connected to the HOST port of the Xiegu X6100 (wired).



Note: A wired network connection via a LAN adapter connected to the HOST port of the Xiegu X6100 has the advantage that weak Wi-Fi signals and the resulting packet loss are avoided.

13.2 Required connectivity settings

WFVIEW is required to access the WFSERVER of the Xiegu X6100 via LAN or WLAN.

13.2.1 Installing WFVIEW

WFVIEW is so-called open source software. It is licensed under GNU/GPL V3. You can find the software for various target platforms on the <https://wfview.org/> website.

13.2.1.1 Download von WFVIEW

Download the appropriate release for your computer's operating system from the website mentioned above. Releases for Linux, MacOS as well as x86 and x64-

based Windows versions are currently available. The screenshots in the rest of this document were created using x64 version 1.64 on a Windows 11-based PC.

13.2.1.2 Unpacking the WFVIEW download archive

Unpack the download archive in a folder of your choice. As a rule, only the executable installation file is included.

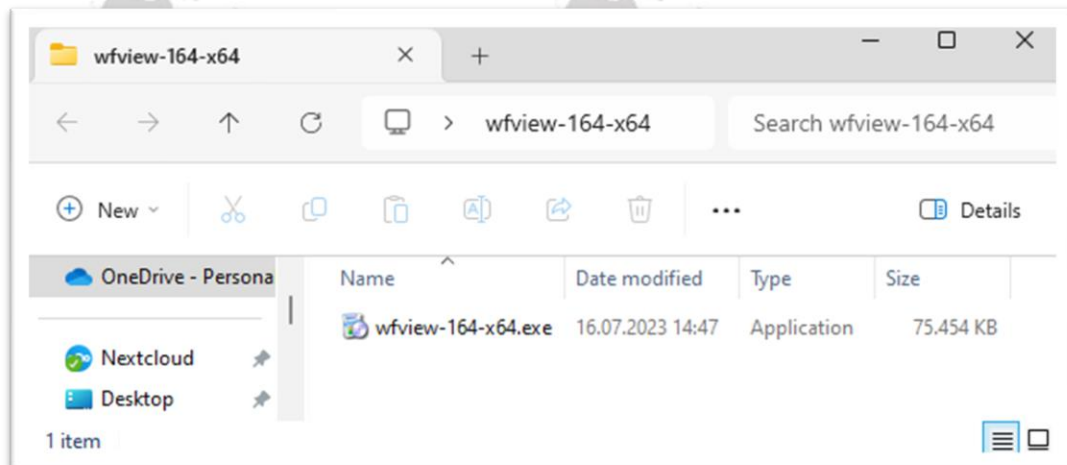

13.2.1.3 Installation von WFVIEW

Now you can start the installation process by double-clicking on the exe file.

Note: *Some versions of windows may warn against download or installation of any software not loaded from the Microsoft webstore and you need to be sure that the executable is from a safe source – you may need to select options such as “keep” or “open anyway” so that the install process will continue.*

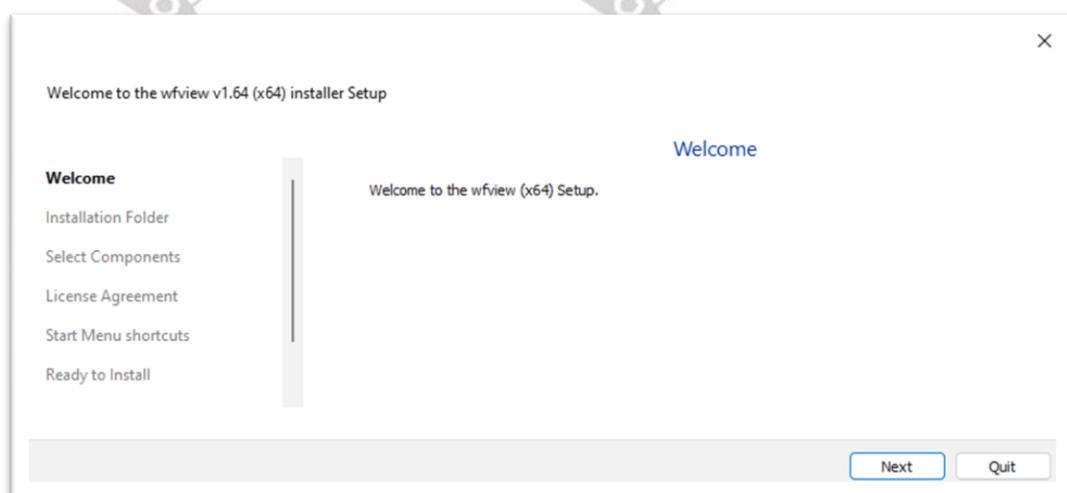

After clicking on you will be asked to specify the installation location.

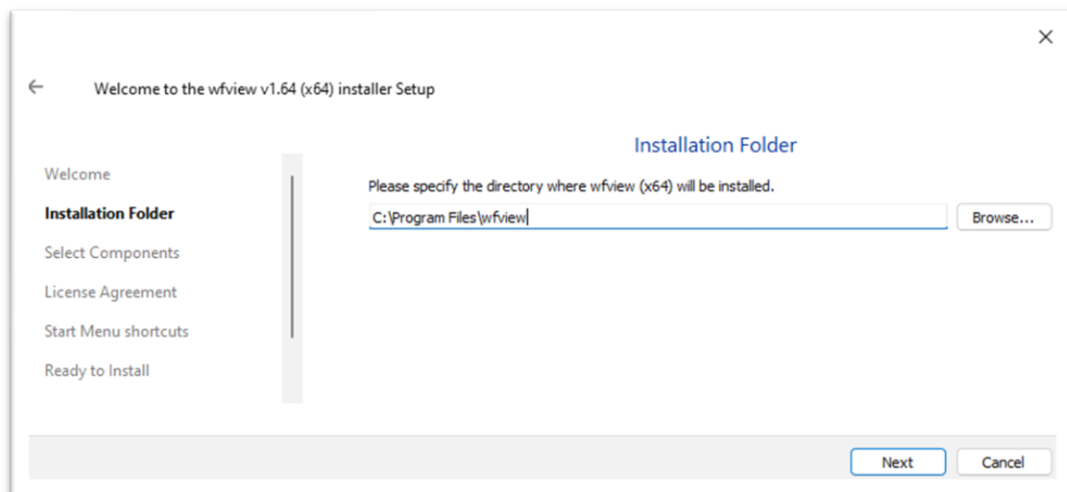

Simply leave it at the suggested installation location and click on again. You can now select the components to be installed.

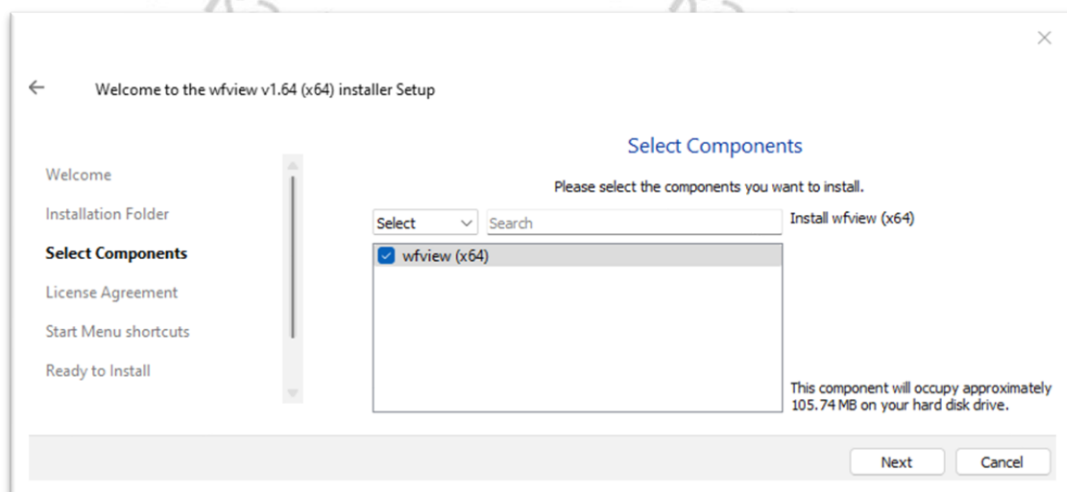

Again, use the default settings and click on as usual. You will then be asked to accept the wfview license agreement. You can only continue if you tick 'I accept the license'.



You can then click on again. You can now specify the name for the shortcut in the Start menu.

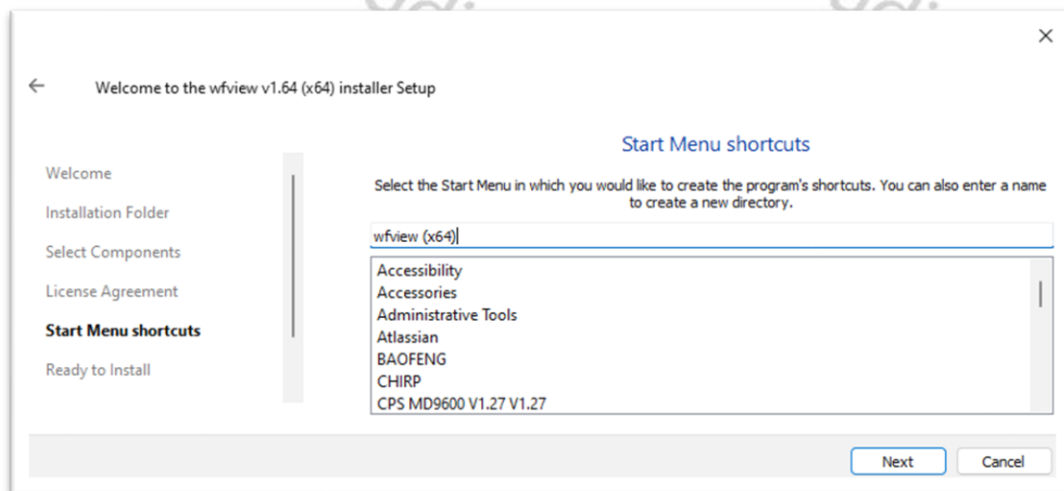

Again, leave the default setting and click on . This was the last required setting.

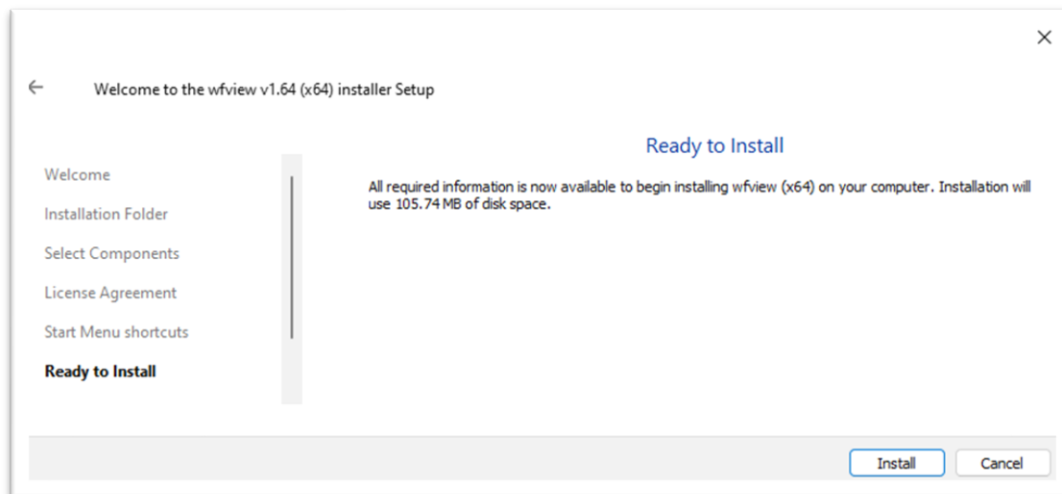

As soon as you now click on , WFVIEW will be installed on your computer. Your operating system may ask you for confirmation beforehand.

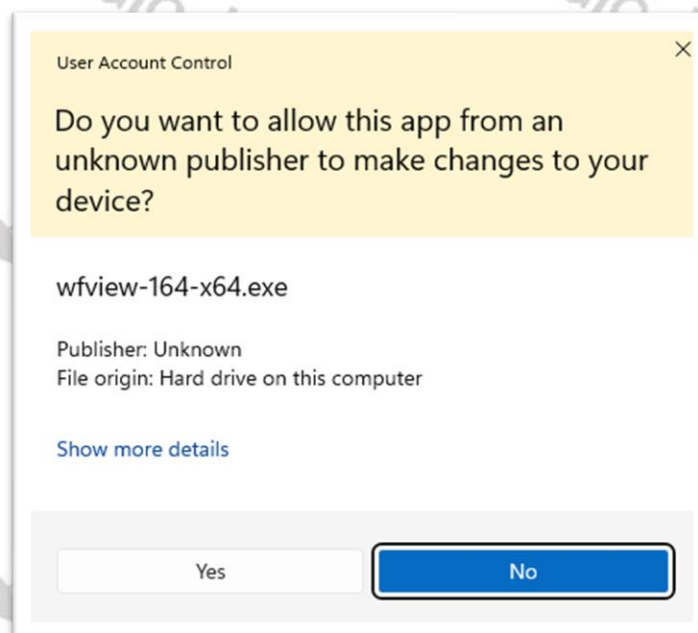

Confirm this by clicking on . WFVIEW will be installed on your computer after just a few seconds.

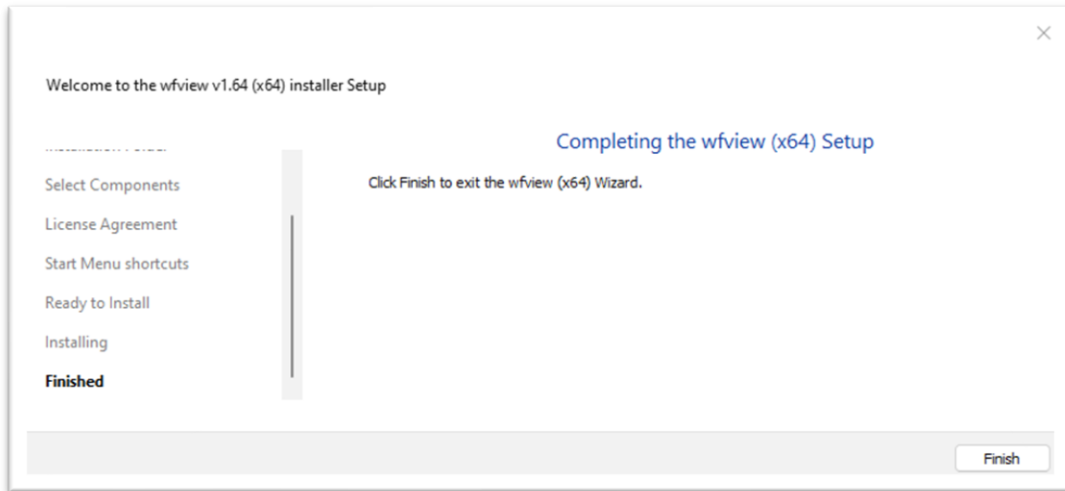

Click on to complete the installation.

13.3 Preparing Xiegu X6100 for Wi-Fi access

To use wfview, the WLAN of the Xiegu X6100 must be switched on and configured accordingly. Details on this can be found in the section 10.1.4.4 starting on page 50.

13.4 Starting WFSERVER on Xiegu X6100

Now WFSERVER must be started on the Xiegu X6100 before the Xiegu X6100 can be accessed with WFVIEW.

To start the WFSERVER on the Xiegu X6100, first press the following buttons in succession: [GEN] → SYSTEM SETTING to access the menu for the system settings.

Now select 'WFSERVER' by turning the MFK rotary control (bottom left next to the LCD).

Note: *If no WFSERVER option is displayed you are not using the required version of APP and BASE firmware – see earlier.*

Confirm your selection by briefly pressing the MFK rotary control.

You will now see the various WFSERVER setting parameters. Please leave the settings at their default values. You can change the settings later if necessary.

RIG NAME	X6100
USER NAME	user
PASSWORD	123
CTRL PORT	50001
CIV PORT	50002
AUDIO PORT	50003

With wfview server from the wfview team:
Elliott (W6EL), Phil (M0VSE), Roeland (PA3MET) and
Jim (PA8E).
Source code available at wfview.org

START DEFAULT CLEAR SAVE EXIT

Briefly press the softkey labeled 'START' to start WFSERVER on your Xiegu X6100.

Please Wait

With wfview server from the wfview team:
Elliott (W6EL), Phil (M0VSE), Roeland (PA3MET) and
Jim (PA8E).
Source code available at wfview.org

START DEFAULT CLEAR SAVE EXIT

After about half a minute, the WFSERVER is started.

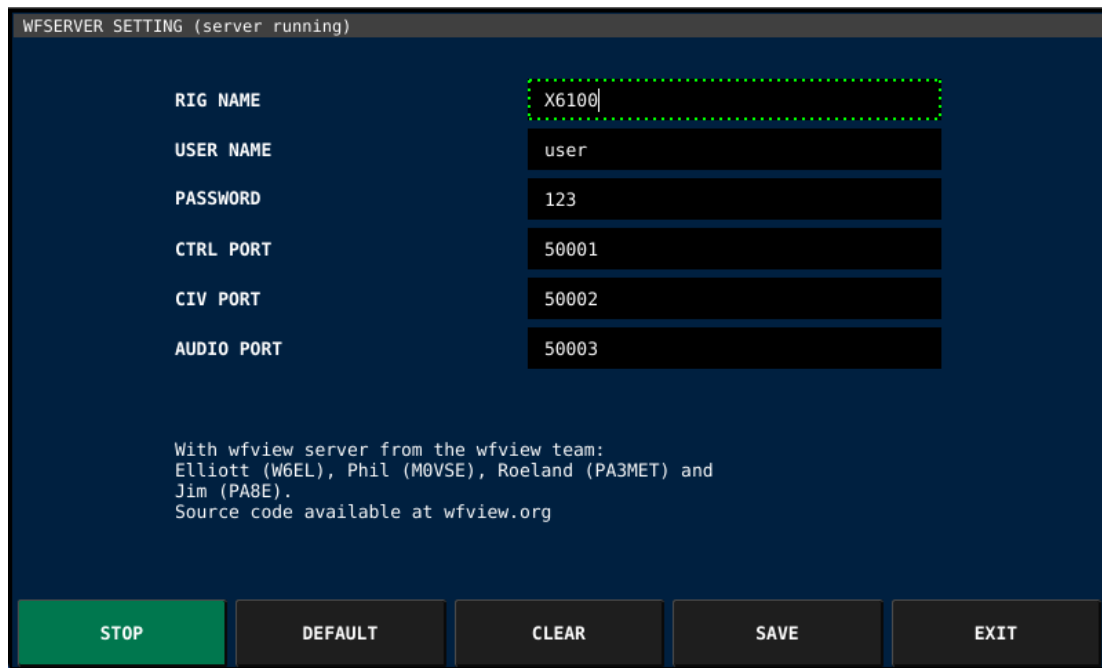

Then press 'EXIT' to return to the submenu. Press 'EXIT' again to return to the main screen. After the start, the blue WF symbol appears to the left of the supply voltage display.



13.5 Starting WFVIEW on the computer

When you start WFVIEW on the computer for the first time, you may initially receive an error message.

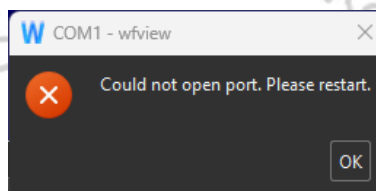

This is because you have not yet defined how WFVIEW should communicate with the Xiegu X6100.

Click on  to confirm that you wish to read the error.



Then click on 'Settings' in the application to call up the menu for the WFVIEW settings.

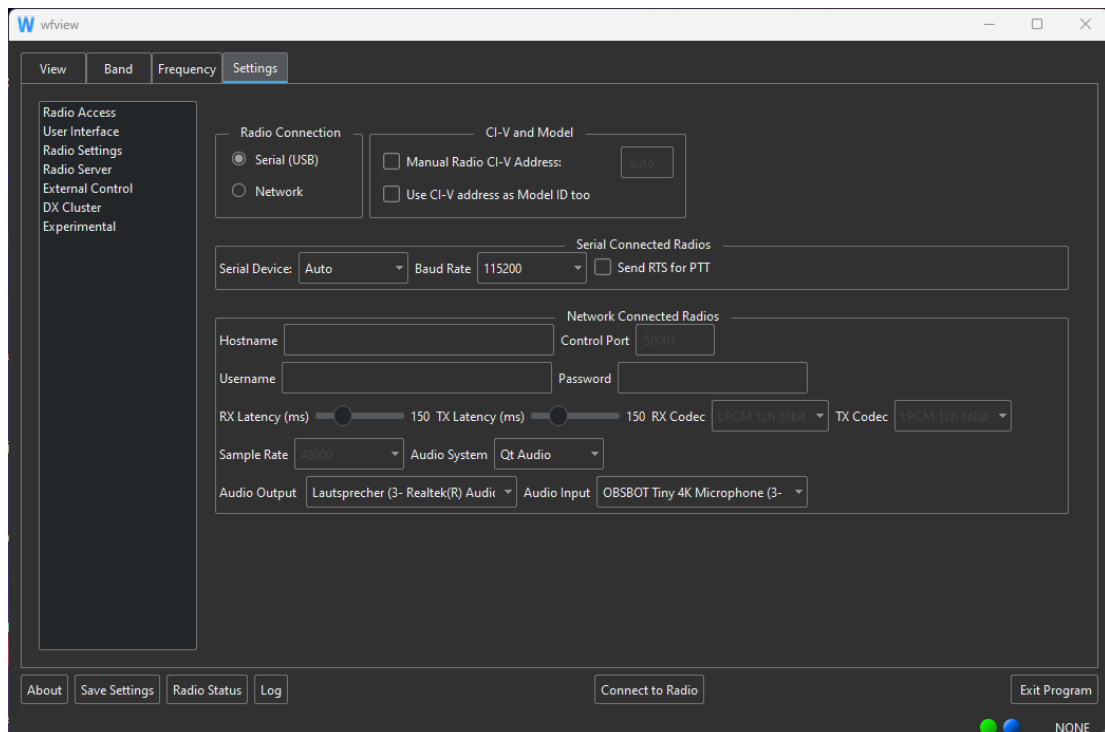

In the menu tree on the left-hand side of the application, click on **Radio Access** to call up the corresponding submenu.

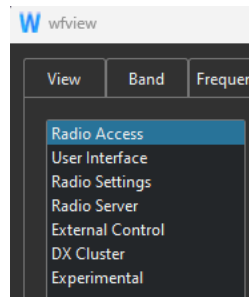

Select 'Network' under 'Radio Access' as the connection type for pairing the Xiegu X6100.

Please set the parameters for 'Network Connected Radios' as follows:

- **Hostname:** Enter the IP address of the Xiegu X6100 here (in the example this was 192.168.2.199).
- **Control Port:** Enter the CTRL port number of the WFSERVER here. If you have not changed this, it is '50001'.

CTRL PORT 50001

- **Username:** Enter the user name of the WFSERVER here. If you have not changed this, it is 'user'.

USER NAME user

- **Password:** Enter the password for the WFSERVER user name here. If you have not changed it, it is '123'.

PASSWORD 123

This results in the following settings as an example:

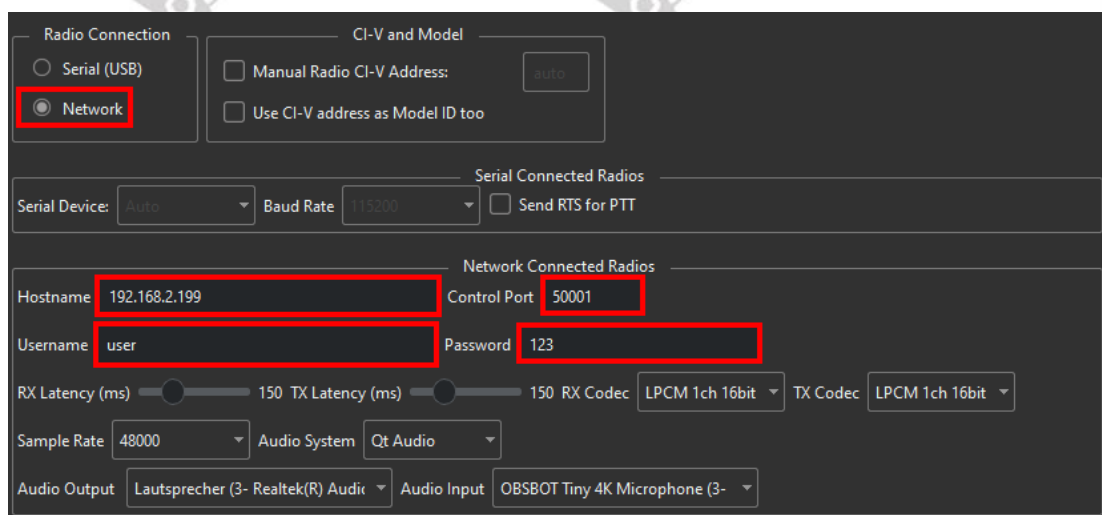

You should then check the audio output and input settings for wfview running on your computer. These can be found under the heading 'Audio Output' and 'Audio Input' below the previously adjusted communication settings.

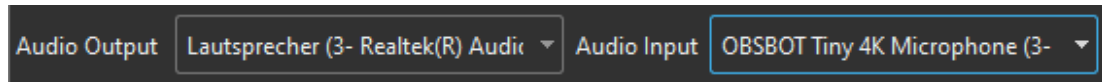

Once you have made all the settings in the wfview program on your PC, you can now click on the button **Connect to Radio** (connect to radio) to establish the communication link between WFVIEW (on your computer) and WFSERVER (on your Xiegu X6100). You will notice that now, regardless of the volume setting on the Xiegu X6100, the received signal is also played back on your PC loudspeaker.

Now click on **View** (view) in the top navigation line of WFVIEW to switch to the display of the remote radio.

You can now control and use your Xiegu X6100 from anywhere on your home LAN using your PC/Laptop.

If you wish to connect from outside of your home LAN, small changes to your home router will be needed and possibly the allocation of a DDNS hostname. This is outside of the scope of this manual as different makes and models of home routers are configured differently - refer to your routers manual for how to configure it to support access from the Internet.

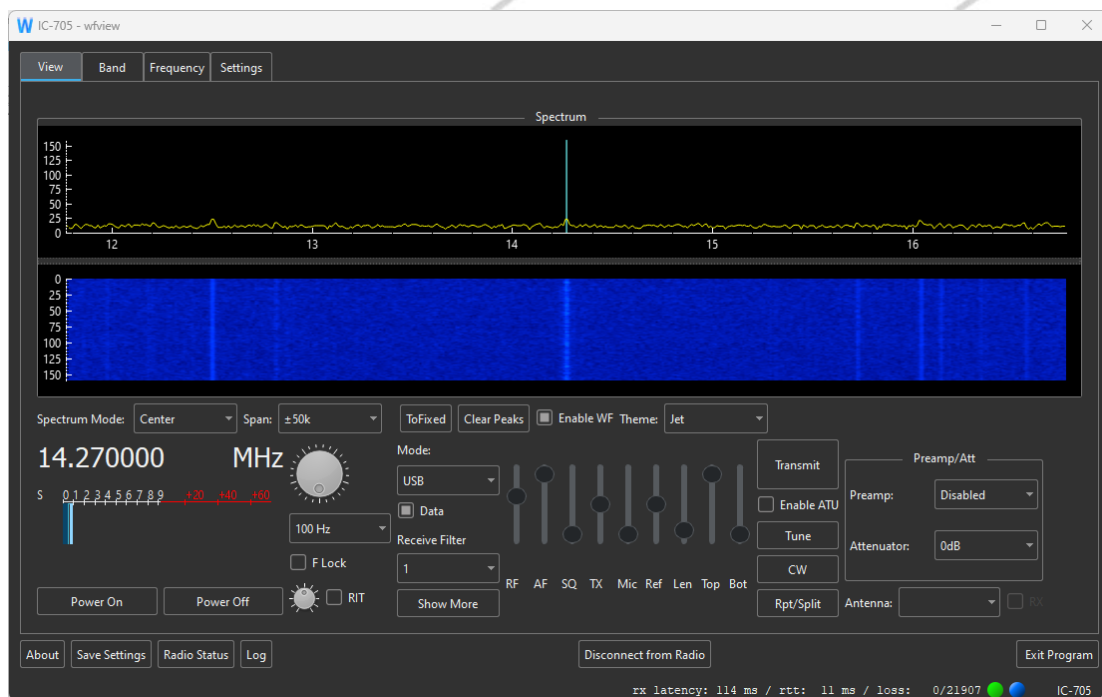



14 Connecting accessories

A wide range of accessories can be connected to the Xiegu X6100.

14.1 Accessories for the Xiegu X6100

Radioddity does offer a wide range of further accessories that do add value, power and more comfort to your Xiegu X6100.

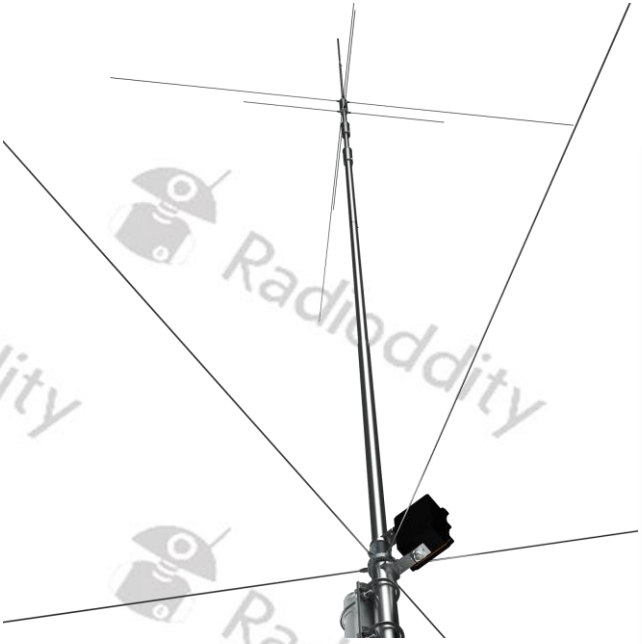
Part	Picture
<p>Xiegu XPA12B 100W Power Amplifier</p> <ul style="list-style-type: none"> • Built-in Automatic Antenna Tuner • up to 125W Power Output • Large 2.7 inch Screen Display 	
<p>Xiegu L4001 Cable to control Xiegu XPA125B by Xiegu X6100</p>	
<p>Xiegu GNR1 Digital Audio Noise Filter</p> <ul style="list-style-type: none"> • 3W audio output • Input/output volume adjustment • High/low input impedance select • Double audio output (3.5mm stereo output, RCA output) • Headphone output & Automatic switch (headphone/speaker output) 	

Part	Picture
<p>Xiegu VG4 40m/20m/15m/10m 4-band Vertical Antenna</p> <ul style="list-style-type: none"> • For 4 frequency bands: 7/14/21/28MHz (40m/20m/15m/10m) • Axial length: about 7.8m 25.6ft • Radial length: about 2.7m 8.8ft • Maximum power handling: 1000W PEP (CW500W, RTTY300W) • Antenna impedance: 50Ω • VSWR: < 1.5:1 • Antenna bandwidth: 40m: 150kHz / 20m: 450kHz / 15m: 800kHz / 10m: 1000kHz • Rated wind speed: 35 m/s • Antenna interface type: SL16-K • Weight: about 7.0kg 15.4lb • Package size: 13x13x120cm 0.4x0.4x3.9ft • Erection height: the distance from the ground is more than 3m (10ft) 	
<p>Radioddity HF-008 Portable Antenna</p> <ul style="list-style-type: none"> • For 9 frequency bands: 6m, 10m, 11m, 12m, 15m, 17m, 20m, 40m, 80m • Maximum power (PEP): 200W (SSB) • VSWR: < 1.5:1 • Antenna impedance: 50Ω • Antenna interface type: PL-259/SL16-K • To be used in combination with Radioddity RA-M5 or Radioddity M916 Antenna Magnet Mount on a car. 	

Part	Picture
<p>Radioddity M916 3 base Magnet Mount</p> <ul style="list-style-type: none">• Heavy duty rugged magnetic antenna mount• With 3 magnetic bases (each with a diameter of 11cm / 4.3") this magnetic mount is your ideal car roof mount for PL-259 verticals (such as the HF-008) for static mobile operation• SO-239 socket• 3,9m / 153" RG58-A/U cable with PL-259/SL16-K connector at its end• Comes with adapter SO-239 to BNC-m (to fit the Xiegu X6100)	 A black triangular magnetic antenna mount with three circular bases. A coiled black cable with a PL-259 connector is attached to the top. A small SO-239 to BNC-m adapter is shown separately.
<p>Radioddity RA-M5 Antenna Magnet Mount</p> <ul style="list-style-type: none">• For car roof mount of PL-259 verticals (such as the HF-008) and static mobile operation• SO-239 socket• 5m / 197" cable with PL-259/SL16-K connector• Diameter: 90mm / 3.54"	 A circular magnetic antenna mount with a coiled black cable. The cable has a PL-259 connector at one end and an SO-239 socket at the other.
<p>Xiegu GY03 External Speaker</p> <ul style="list-style-type: none">• 3W power• 4Ω impedance• 3.5mm TRS• 10-feet audio cable	 A black rectangular external speaker with a grille on top and a mounting bracket at the bottom. The brand name 'XIEGU' is visible on the top surface.

Part	Picture
<p>Raddy Multi-function Backpack</p> <p>measures: 30 cm x 16 cm x 36 cm / 11,8" x 6,3" x 14,2"</p> <p>volume: 15 dm³ / 0.53 ft³</p> <p>weight: 800g / 1.8 pound</p> <p>perfectly matches to the Xiegu X6100 + Xiegu XA125B</p>	
<p>Radioddity PB3^{*)} Carrying Case</p>	

Part	Picture
<p>Radioddity X6100-H1^{*)} Protective bracket</p>	
<p>Xiegu X6100 Spare-Parts Kit</p> <ul style="list-style-type: none"> • 1 x X6100 EC11 encoder • 1 x TF self-elastic deck • 1 x Fast-blow fuse(4A/63V/I2t=3.2~4.2) • 1 x X6100 side plastic frame • 1 x X6100A decorative part • 2 x Bracket steel ball stainless steel(diameter 2.38mm) • 1 x MIC seat • 1 x Antenna Q9 • 3 x Knob • 1 x Tempered glass • 6 x RF connector U.FL socket • 2 x RF connection cable(Double-ended IPEX RF1.13 cable, length 50mm) • 1 x Electret microphone/6030 • 3 x 3x6x2.5mm patch button 	

Part	Picture
<p>Xiegu DH100 100W Portable Power Station</p> <ul style="list-style-type: none">• Capacity: 24000mAh, 88.8Wh• Dimensions (LWH): 155mm x 110mm x 110mm (6.1" x 4.3" x 4.3")• Weight: 1.03 kg (2.3 lbs)• Built-in Battery: Lithium-ion Batteries• Input Recharging: Adapter: 15V/2A; DC: 12-25V/2A• Fully Charged Time: DC15V/2A: 3hrs• Output: USB1: Max 3.1A USB2: 5V/2A, 10W; 9V/2A, 18W; 12V/1.5A, 18W DC: 12V/8A• Wireless Charger: 5V/2A, 10W; 9V/1A, 9W• Type-C: 5V/3A, 15W; 9V/3A, 27W; 12V/3A, 36W; 15V/3A, 45W; 20V/3A, 60W	 <p>The image shows a grey and white Xiegu DH100 100W Portable Power Station. It is a rectangular device with a white top and bottom. The front panel features a wireless charging pad on top, an AC input port, a power button, and several output ports including USB-A, USB-C, and DC. The Xiegu logo is visible on the front panel.</p>

*) Pictures of the accessories shown sometimes show additional items to the product in operation. Additional items are only shown for a better understanding and are not included with the product.

14.2 Connecting the Xiegu hand-held microphone

The hand-held microphone is connected to the Xiegu X6100 via the 8-pin RJ-45 socket using a spiral cable. The signal assignment of the RJ-45 socket on the Xiegu X6100 is as follows:

Signal	Meaning	RJ45	Color
MDATA		8	grey
GND	Ground	7	black
MIC	Microphone signal	6	green
MICE	Microphone Ground	5	orange
PTT	Xiegu X6100 goes into transmit mode as soon as this input line is connected to ground	4	white
MWVSW		3	yellow
NC	Not used	2	red
+8V	Supply voltage for the electronics of the hand-held microphone	1	blue

14.3 Connecting a Morse key

The Xiegu X6100 can be connected to simple manual Morse keys as well as paddles and automatic character keyers.

14.4 Connecting the Xiegu XPA125B HF amplifier

To connect the Xiegu XPA125B RF amplifier to the Xiegu X6100, you need the additional cable L4001. The cable must be purchased separately as it is not included with the Xiegu X6100 or the Xiegu XPA125B.

The L4001 cable has a 4-pin 3.5mm TRRS jack plug on the end plugged into the Xiegu X6100 and a miniDIN 8 connector plug on the end that is plugged into the Xiegu XPA125B. The assignment of the cable cores is as follows:

Xiegu X6100	Signal	Function	XPA125B
Tip	TRX / PTT	Switch Transmit signal	2
Ring 1	BAND_V	Voltage to trigger correct amplifier band selection	3
Ring 2	ALC_V	ALC Voltage for control of drive power from the X6100	4
Sleeve	GND	Ground	6

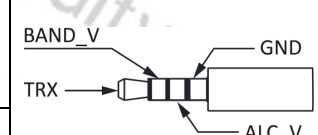

Now install a suitable BNC to PL-259 Coaxial cable between the X6100 output and the XPA125B input sockets and add an antenna cable (with adapter if needed) to the SO239 output socket on the XPA125B.

After the Xiegu X6100 is connected to the Xiegu XPA125B via the L4001 cable, an output power of up to 100 W PEP can be achieved.

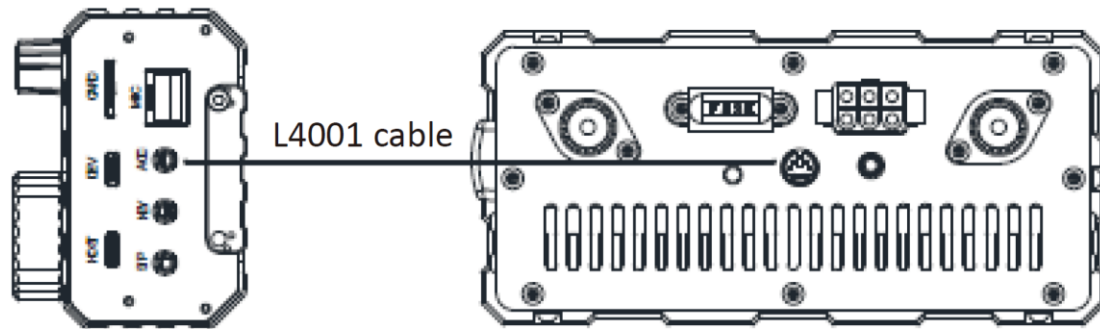

The Xiegu X6100 automatically switches the frequency band of the Xiegu XPA125B, so the operator can concentrate on the controls on the X6100. ALC control is performed between the two devices, so that if the output power of the Xiegu X6100 exceeds the input power limit of the Xiegu XPA125B the ALC control automatically reduces the output power of the Xiegu X6100 hence the output power of the Xiegu XPA125B is maintained safely at around 100 W.

We recommend setting the output power of the Xiegu X6100 to ≤ 2.5 W to protect the amplifier input.

To select the correct frequency band settings for the XPA125B, the Xiegu X6100 outputs a indicative voltage to the connected Xiegu XPA125B in 230 mV steps via the ACC connection.

Frequency band	Voltage	Frequency band	Voltage
1,8 MHz	230 mV	18 MHz	1610 mV
3,5 MHz	460 mV	21 MHz	1840 mV
5,0 MHz	690 mV	24 MHz	2070 mV
7,0 MHz	920 mV	28 MHz	2300 mV
10 MHz	1150 mV	50 MHz	2530 mV
14 MHz	1380 mV		

14.4.1 Tuning the Xiegu XPA125B antenna tuner

As it is the XPA125B that is connected to your antenna, the antenna tuner to be used is the one in the amplifier not the one in the X6100. The antenna tuner contained in the Xiegu XPA125B requires a constant carrier for tuning. This is not the case with an SSB transmission. To adjust the Xiegu XPA125B to the current settings of the Xiegu X6100, proceed as follows:

- On the Xiegu X6100, select the frequency band on which you want to work.
- Make sure that the frequency band of the Xiegu XPA125B is the same as the one set on the Xiegu X6100.
- First set the operating mode of the Xiegu X6100 to AM



- Set the output power of the Xiegu X6100 to maximum.

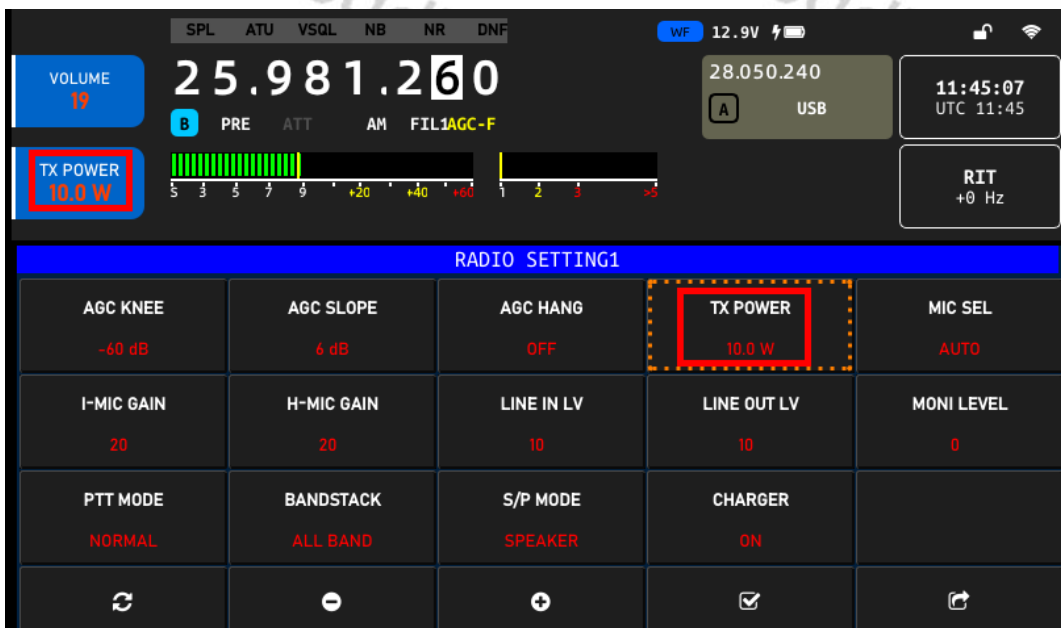

- Press the PA button on the Xiegu XPA125B (if necessary) to switch off the amplifier of the Xiegu XPA125B.



- Switch off the automatic antenna tuner of the Xiegu X6100 (if necessary).



- Now press the [PTT] talk button on the microphone of the Xiegu X6100.

- Make sure that the Xiegu X6100 is not operated in split mode unless it is operated on the same band for transmitting and receiving.



- Now press and hold the ATU button on the Xiegu XPA125B ATU to start an antenna adjustment
- Release the previously pressed [PTT] talk button on the microphone of the Xiegu X6100 as soon as the adjustment is complete.
- Now set the output power of the Xiegu X6100 to 5 watts. When using an external power supply, the output power of the Xiegu X6100 should not exceed 8 watts to avoid overloading the input of the Xiegu XPA125B. However, to protect the Xiegu XPA125B, we recommend setting the output power of the Xiegu X6100 to a maximum of 2.5W.
- Now turn ON the amplifier (PA) of the Xiegu XPA125B.



- Now switch the operating mode of the Xiegu X6100 back to SSB (LSB/USB).

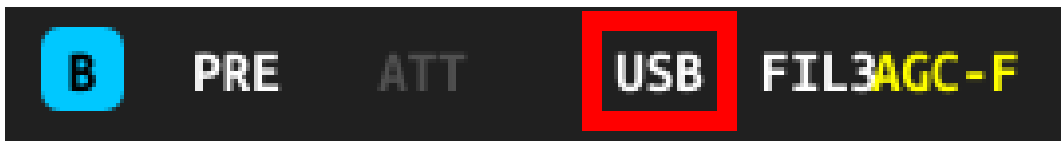

The Xiegu XPA125B is now adjusted to the connected antenna and the currently selected frequency band and is therefore ready for operation.

Note: *If you change band you will need to repeat this operation.*

14.5 Connecting the Xiegu X6100 to a computer (DEV)

The USB-C type socket labeled 'DEV' on the right-hand side of the Xiegu X6100 can be used to connect the Xiegu X6100 to a PC as a USB device (DEvice) using the USB-A to USB-C cable provided.

From the PC's point of view, the Xiegu X6100 provides two serial interfaces of TYPE CH342.

- ✓ Ports (COM & LPT)
 - USB-Enhanced-SERIAL-A CH342 (COM7)
 - USB-Enhanced-SERIAL-B CH342 (COM8)

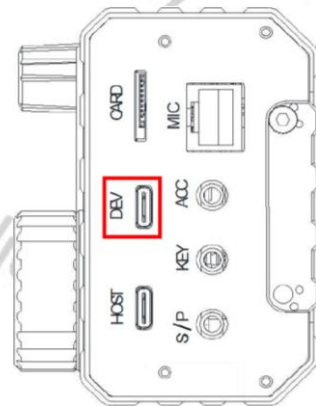

The virtual port labeled SERIAL-B is used for digital operating modes such as FT8 via WSJT-X and for CAT control.

The Xiegu X6100 also provides both a USB audio input and output for the PC:

- ✓ Audio inputs and outputs
 - Lautsprecher (2- USB Audio Device)
 - Mikrofon (2- USB Audio Device)

These two audio 'devices' are also used by programs such as WSJT-X. An additional sound card is therefore not required for digital operating modes from the PC.

14.6 Connecting USB accessories to the Xiegu X6100 (HOST)

The Xiegu X6100 can not only be connected to a PC as a USB device, as described in the previous section, but it can also function as a HOST device itself.

The port labeled 'HOST' on the right-hand side of the Xiegu X6100 is used for this purpose. A compatible USB-C hub, mouse, keyboard and LAN adapter can be connected to this port using appropriate adapters.

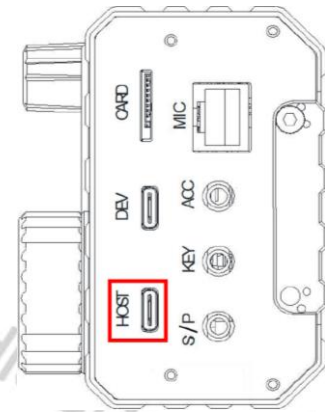

15 CI-V

CI-V is an abbreviation for 'Computer Interface, version V', it was introduced by ICOM and has been used for CAT control or their radios for several decades. The Xiegu X6100 uses a subset of the standard CI-V CAT instruction set. The CI-V codes sent remotely control the transceiver based on standard instructions as well as being able to configure some of the radio. PC programs can use these control instructions to extract data (e.g., frequency, mode) or to control the radio during data transmission. For the Xiegu X6100, the PC-radio serial communication is carried out between the Xiegu X6100 DEV port and the PC via a USB cable. No extra interface hardware is needed.

The following tables do refer to the latest firmware as listed in chapter 12 on page 82. Other firmware versions may have slight differences.

Table 1 (part 1 of 5)				
CMD	Sub-CMD	data	description	rigs (Note 1)
0x00	-	See Table	Set active VFO frequency	
0x01	-	See Table	Set active VFO mode	
0x02	-	See Table	Get frequency edge	
0x03	-	See Table	Get active VFO frequency	
0x04	-	See Table	Get active VFO mode	
0x05	-	See Table	Set active VFO frequency	
0x06	-	See Table	Set active VFO mode	
0x07	-	-	Select the VFO mode	
	0x00	-	Select VFO-A	
	0x01	-	Select VFO-B	
0x0F	0xb0	-	Swap VFO-A/B	
	0x00	-	SPLT OFF	
0x11	0x01	-	SPLT ON	
	X	-	Toggle ATT(X=don't care)	
	-	-	Get ATT	

Table 1 (part 2 of 5)				
CMD	Sub-CMD	data	description	Rigs (Note 1)
0x14	0x01	-	Get AF level (Rx volume, return form, 0~100% map to 0000~0255, same below) values are in BCD code	X6100,G90
	0x02	-	Get RF gain	X6100,G90
	0x03	-	Get SQL level	X6100
	0x06	-	Get NR level	X6100,G90
	0x09	-	Get CW sidetone frequency	X6100,G90
	0x0A	-	Get Tx power	X6100,G90
	0x0B	-	Get Mic gain	X6100,G90
	0x0C	-	Get CW key speed	X6100,G90
	0x0D	-	Get DNF center frequency	X6100
	0x0E	-	Get COMP level	X6100
	0x0F	-	Get QSK time	X6100,G90
	0x12	-	Get NB level	X6100,G90
	0x15	-	Get MONI level	X6100,G90
	0x16	-	Get VOX gain	X6100
	0x17	-	Get ANTI-VOX gain	X6100,G90
	0x19	-	Get LCD backlight level	X6100,G90
	Others	-	Always return 0000(in BCD code)	
	0x01	BCD code	Set AF level(0000~0255 map to 0~100%,same below)	X6100,G90
	0x02	BCD code	Set RF gain	X6100
	0x03	BCD code	Set SQL level	X6100
	0x06	BCD code	Set NR level	X6100
	0x09	BCD code	Set CW sidetone frequency	X6100,G90
	0x0A	BCD code	Set Tx power	X6100,G90
	0x0B	BCD code	Set Mic gain	X6100,G90
	0x0C	BCD code	Set CW key speed	X6100,G90
	0x0D	BCD code	Set DNF center frequency	X6100
	0x0E	BCD code	Set COMP level	X6100
	0x0F	BCD code	Set QSK time	X6100,G90
	0x12	BCD code	Set NB level	X6100,G90
	0x15	BCD code	Set MONI level	X6100
	0x16	BCD code	Set VOX gain	X6100,G90
	0x17	BCD code	Set ANTI-VOX gain	X6100,G90
0x19	BCD code	Set LCD backlight level	X6100	

Table 1 (part 3 of 5)					
CMD	Sub-CMD	data	description	Rigs (Note 1)	
0x15	0x01	-	Get SQL Gate,00=Close,01=Open		
	0x02	-	Get S-Meter, 0000~0255 BCD code		
	0x11	-	Get Power-Meter, 0000~0255 BCD code		
	0x12	-	Get SWR-Meter, 0000~0255 BCD code		
	0x13	-	Get ALC-Meter, 0000~0255 BCD code		
	0x15	-	Get VOLT-Meter, 0000~0255 BCD code		
0x16	0x02	-	Get PRE switch		
	0x12	-	Get AGC mode		
	0x22	-	Get NB switch		
	0x40	-	Get NR switch	X6100	
	0x41	-	Get DNF switch	X6100	
	0x44	-	Get COMP switch	X6100	
	0x46	-	Get VOX switch	X6100	
	0x50	-	Get dial encoder lock status		
	0x02	0x00		PRE OFF	
		0x01 or 0x02		PRE ON	
	0x12	0x00		AGC OFF	
		0x01		AGC Fast	
		0x02		AGC middle	
		0x03		AGC slow	
	0x22	0x00		NB OFF	X6100,G90
		0x01		NB ON	
	0x40	0x00		NR OFF	X6100
		0x01		NR ON	
	0x41	0x00		DNF OFF	X6100
		0x01		DNF ON	
	0x44	0x00		COMP OFF	X6100,G90
		0x01		COMP ON	
	0x46	0x00		VOX OFF	X6100
		0x01		VOX ON	
0x50	0x00		Dial encoder unlock	X6100	
	0x01		Dial encoder lock		
0x19	0x00	-	Read Transceiver ID		

Table 1 (part 4 of 5)					
CMD	Sub-CMD	data	description	Rigs (Note 1)	
0x1A	0x01	-	Get band stacking register, See Table	X6100	
	0x03	-	Get IF filter width, See Table 2-5		
	0x05	0x00,0x62 (2 bytes)	Get LOCK status	X6100	
	0x06	-	Get data mode switch and filter group	Note 3	
	0x01	D0,D1 (2 bytes)		Set band stacking register, respond data format see Table 2-4	X6100
			D0	1~10, 160m~6m band, other: invalid	
			D1	Not use	
	0x03	D0 (1 byte)	Set IF filter, Not use (D0 could be any value)		
	0x05	0x00,0x62,D0 (3 bytes)		Set LOCK status	X6100
			D0=0x00	Unlock	
			D0=others	Lock	
	0x06	D0,D1 (2 bytes)		Set data mode switch and filter group	
D0			data mode switch, see Data mode & Filter Group Tips		
D1			filter group, see Data mode & Filter Group Tips		
0x1C	-	-	Get PTT switch (Actually get the T/RX status)	Note 4	
	0x00	0x00	Release PTT		
		0x01	Press PTT		
	0x01	0x00	ATU OFF		
		0x01	ATU ON		
0x02		ATU start tuning			
0x1d	0x19	-	Get XIEGU radio ID, See Table 2-7		
0x21	0x00	See Table 2-6	Set/Get RIT frequency	X6100,G90	
	0x01	0x00/0x01	Set/Get RIT setting	X6100,G90	
	0x02	0x00/0x01	Set/Get XIT setting	X6100,G90	
0x25	-	-	Get VFO frequency		
	-	D0~D5 (6 bytes)		Set foreground/background VFO frequency	
			D0	0x00: Foreground VFO	
				0x01: Background VFO	
	D1~D5	VFO frequency, See Table 2-1			

CMD	Sub-CMD	data	description	Rigs (Note 1)
0x26		D0~D3 (4)	Set/Get VFO mode and filter	
		D0	VFO index	
			0: Foreground VFO other: Background VFO	
		D1	Operating mode, See Table 2-2	
		D2	Data mode switch	
			0: OFF other: ON	
		D3	filter group, see Data mode & Filter Group Tips	

BCD frequency	
D[7:4]	10Hz
D[3:0]	1Hz
D[7:4]	1kHz
D[3:0]	100Hz
D[7:4]	100kHz
D[3:0]	10kHz
D[7:4]	10MHz
D[3:0]	1MHz
D[7:4]	1GHz
D[3:0]	100MHz

Mode	
Data	Mode
0x00	LSB
0x01	USB
0x02	AM
0x03	CW
0x05	NFM
0x07	CWR

BCD frequency edge		
Lower	Separator	Higher edge
BCD frequency	1	BCD frequency

Table 2-4 (part 1 of 2)		
Get band stacking register data format, D0~D1 (2 bytes)		
D0: Band index		
Value	HAM Band	Description
0	NO	
1	YES	160m
2	NO	
3	YES	80/75m
4	NO	
5	YES	60m
6	NO	
7	YES	40m
8	NO	
9	YES	30m
10	NO	
11	YES	20m
12	NO	
13	YES	17m
14	NO	
15	YES	15m
16	NO	
17	YES	12m
18	NO	
19	YES	10m
20	NO	
21	YES	6m
22	NO	
D1: Spectrum Display Format		
Value	Description	
0x02	Center mode	
others	Don't care	

Table 2-4 (part 2 of 2)

Set band stacking register respond data format, D0~D39 (40 bytes)

OFFSET	BYTE	Description
0	1	Data mode switch
1	1	Duplex and Tone setting
2	1	Digital squelch setting
3	3	Repeater tone frequency setting
6	3	Repeater tone frequency setting
9	3	DTCS code setting
12	1	DV Digital code squelch setting
13	3	Duplex offset frequency setting
16	8	UR (Destination) call sign setting (always X6100)
24	8	R1 (Access repeater) call sign setting (always empty)
32	8	R2 (Gateway/Link repeater) call sign setting (always empty)

Table 2-5

IF Filter bandwidth

MODE	VALUE	BANDWIDTH(Hz)	STEP(Hz)
SSB/CW	0~9	50~500	50
SSB/CW	10~40	600~3600	100
RTTY	10~31	600~2700	100
AM/NFM	0~49	200~10000	200

Table 2-6

RIT frequency

Byte 0	D[7:4]	10 Hz
	D[3:0]	1 Hz
Byte 1	D[7:4]	1 kHz
	D[3:0]	100 Hz
Byte 2	0X00	+ (plus)
	0X01	#- (minus)

Table 2-7

XIEGU Radio ID

0x0090	G90
0x0106	G106
0x6100	X6100
others	To be done

Note: Old version of FW may not support all of the listed CI-V implementation

Note:

- 1: Blank for all XIEGU radios
- 2: Some command need higher version of FW, make sure FW is up to date
- 3: G90/G106 responds 2 bytes of data, D0=data mode switch, D1 always 0
- 4: Command 0x1C (1 byte, get T/RX status), radio respond 1 byte data, 0=RX status, others=TX status, G90 (FW<=1.79b03) does not support this 1 byte command! Command 0x1C 0x00 0x00/0x01 (3 bytes, set T/RX), radio respond ACK (not the T/RX status!)
Command 0x1C 0x00 (2 bytes, get T/RX status), radio respond the T/RX status

16 Digital modes and CAT-control

16.1 Software for digital modes

As amateur radio operators like to experiment with new technology as well as adapt existing industry standards to the amateur radio world, new modes of radio operation pop up every once in a while. Let's have a closer look on some of those digital and data focused modes that are currently quite popular.

Note: Most digital modes require your transceiver to be set to D-USB (Digital transmission using Upper SideBand), except for RTTY which uses D-LSB (Digital transmission using Lower SideBand).

16.1.1 FT8

FT8 was first publicly proposed in 2017 by Joe Taylor and named after the first letters of the surnames of the two developers Steven Franke (K9AN) and Joe Taylor (K1JT) following the number **8** to indicate, that eightfold frequency shift keying (MFSK8) is being used. Since then, FT8 has become the most popular digital mode on shortwave. The following table lists some of the frequencies used for FT8. These are the current default frequencies in the WSJT-X program.

Band	frequency
160m	1.840 MHz
80m	3.573 MHz
60m	5.357 MHz
40m	7.074 MHz
30m	10.136 MHz
20m	14.074 MHz
17m	18.100 MHz
15m	21.074 MHz
12m	24.915 MHz
10m	28.074 MHz
6m	50.313 MHz intercontinental 50.323 MHz

16.1.2 JS8

JS8 had been derived from FT8 by Jordan Sherer (KN4CRD), resulting in its name **Jordan Sherer 8** (eightfold frequency shift keying). In contrast to FT8, JS8 is mainly focused on the exchange of personal messages with the remote station, like the chat functionality of the various instant messengers. The only software available that currently supports JS8 is called JS8Call (see <http://js8call.com/> for more details).

16.1.3 WSJT

This **Weak-signal** transmission method invented by **Joe Taylor** (K1JT) or WSJT-X as its current version, is rather a group of transmission protocols and free amateur radio software for communication using weak signals.

16.1.4 WSJT-X

As already mentioned in chapter 16.1.3 on page 114, WSJT-X is a group of transmission protocols and free amateur radio software for communication using weak signals. In order to get it running as expected, a few settings are required. Click on 'File' → 'Settings' to get there.

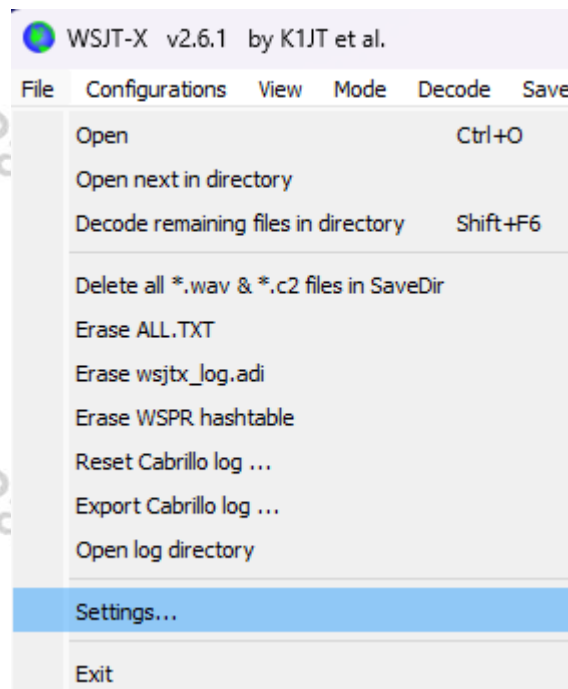

The following screenshots do show examples of such.

Within the 'General' tab you set your callsign, grid locator and IARU region. You may want to alter the 'Tx watchdog' value that does define the time at which WSJT-X gives up in case it could not successfully manage a QSO.

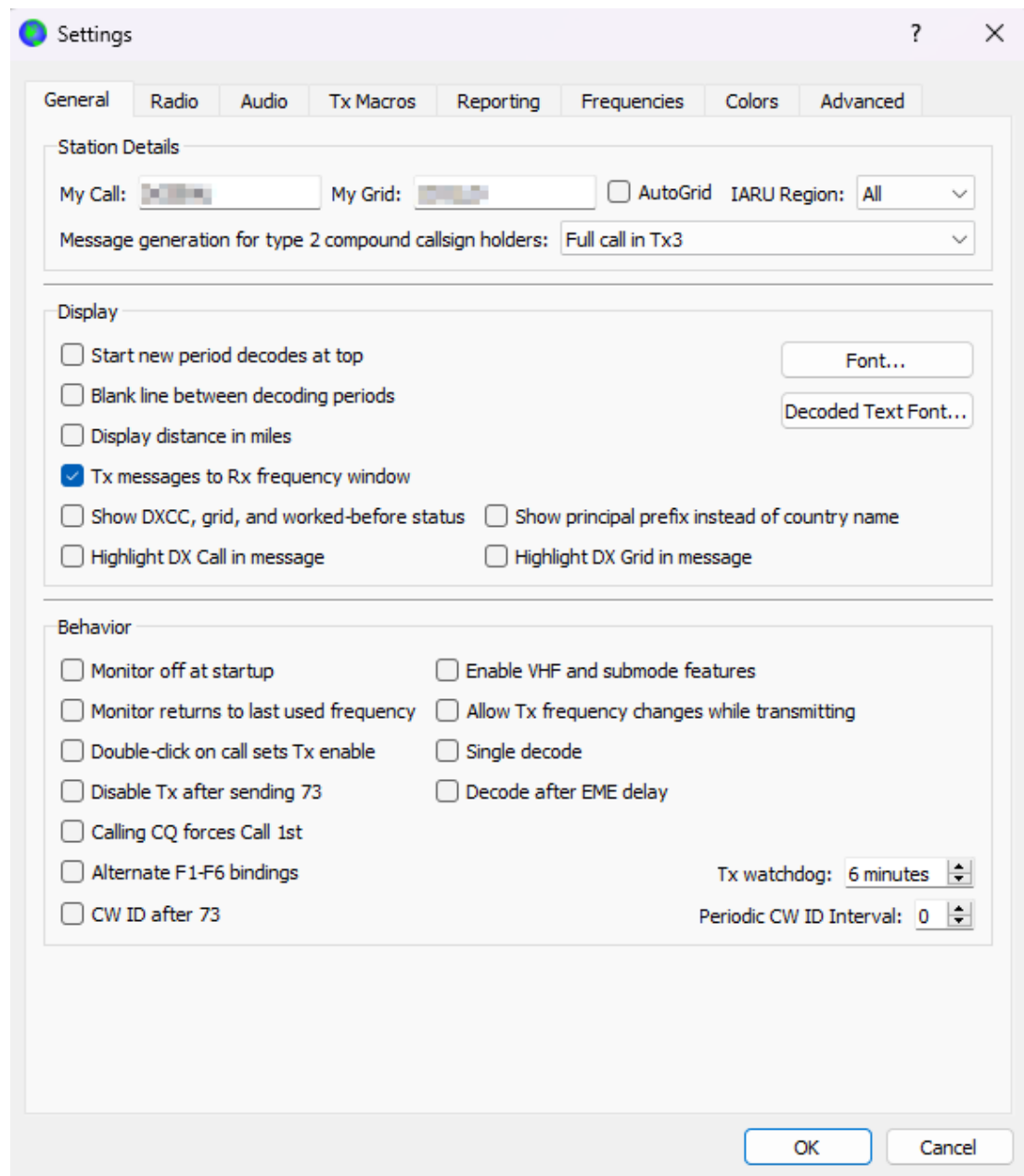

Within the 'Radio' tab you select your radio.

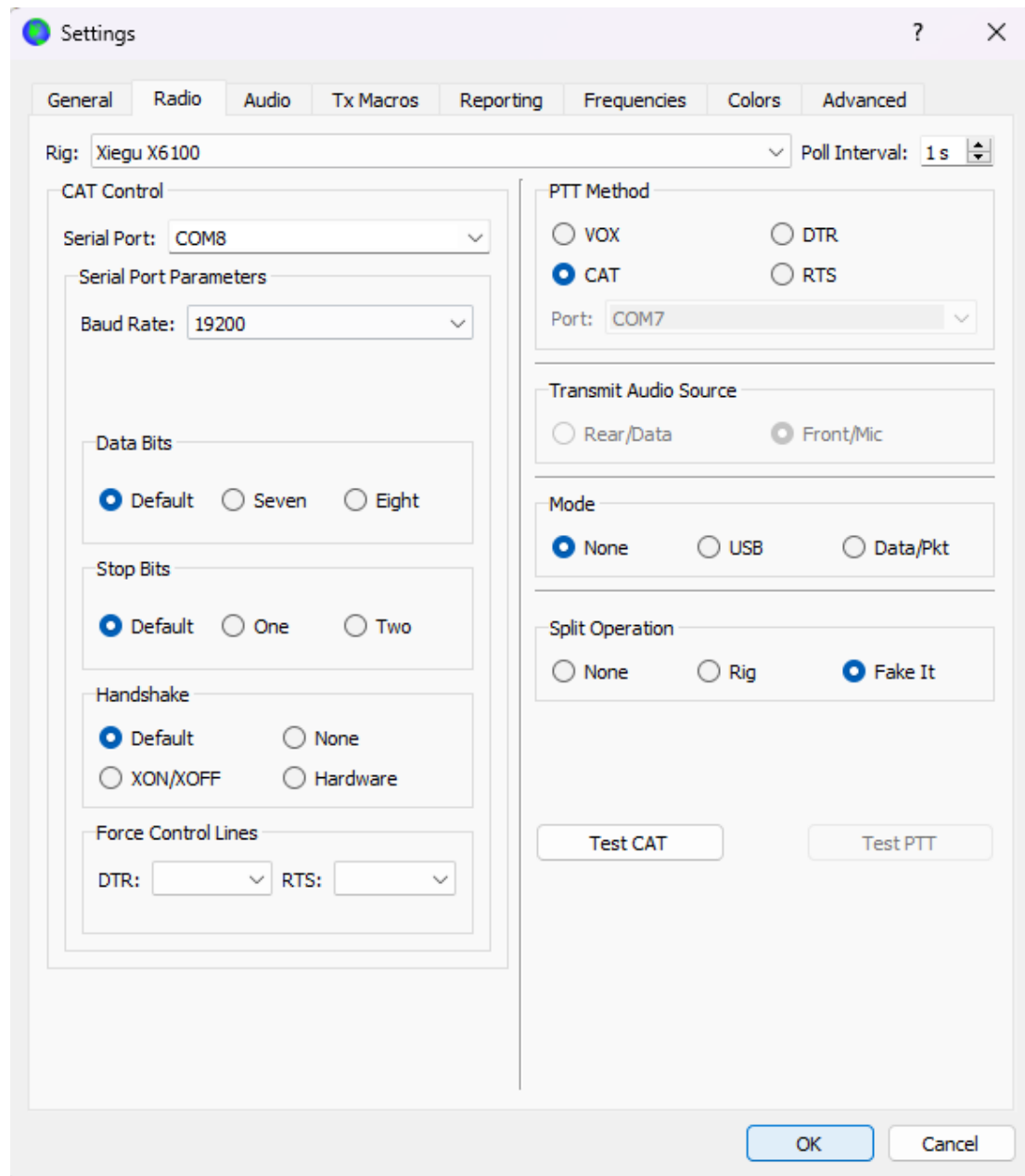

And not to forget the 'Audio' tab that is used to define the input and output signals used from your PC.

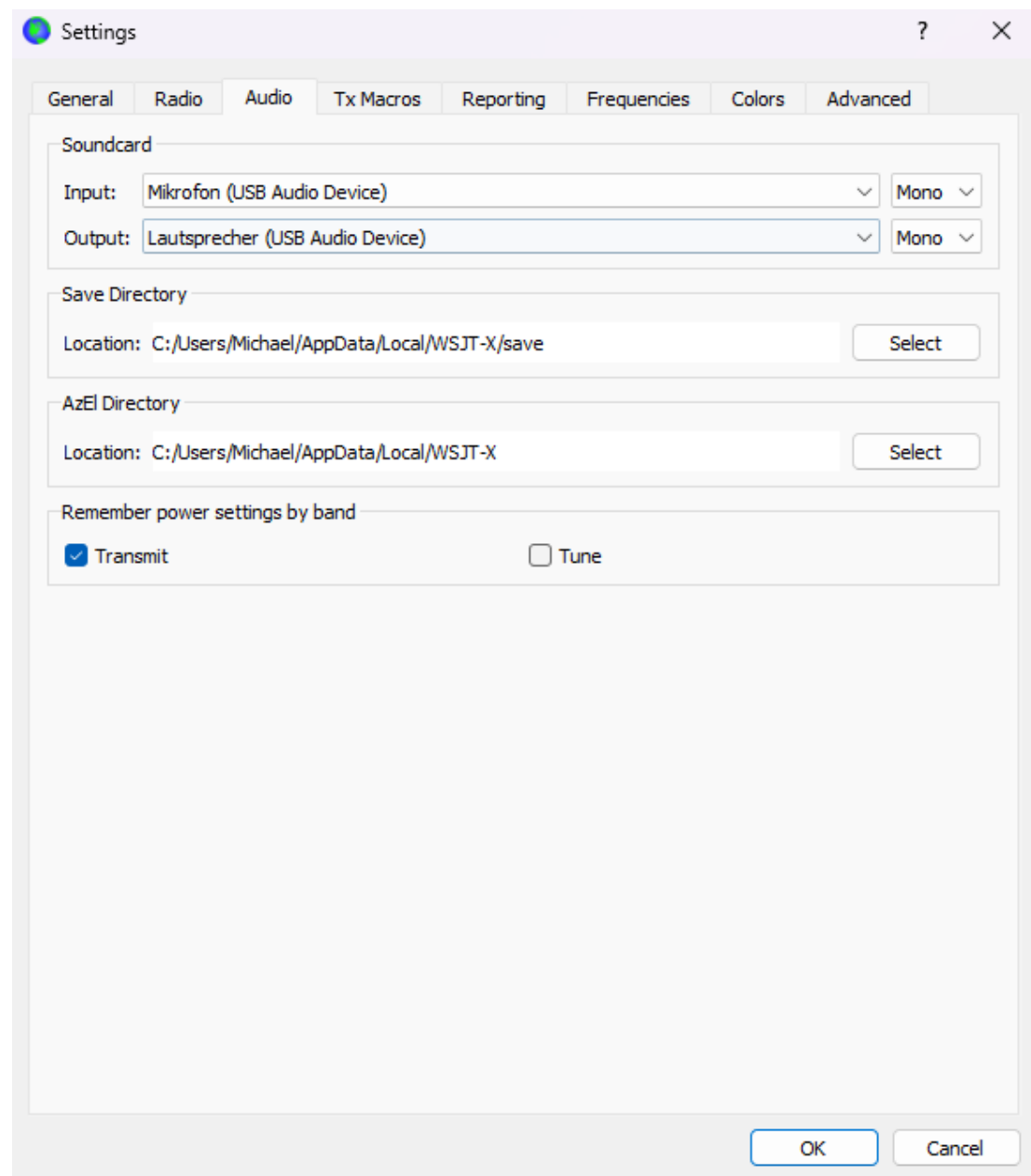

If all is setup correctly you should be able to decode digital signals. In order to make a QSO with another station you have to manually enable TX by clicking the 'Enable TX' button. The function will automatically be deactivated as soon as your QSO has been completed or the TX watchdog has kicked in.

<https://wsjt.sourceforge.io/wsjt.html>

16.1.5 FLdigi

Fast Light **d**igital Modem Application, pronounced 'F L digi' and abbreviated as FLdigi, is a cross-platform modem program that supports most of the peer-to-peer (live keyboard) digital modes used on the amateur radio bands.

Fldigi does require a PC with a soundcard in order to route analog input and output via the sound card of your PC.

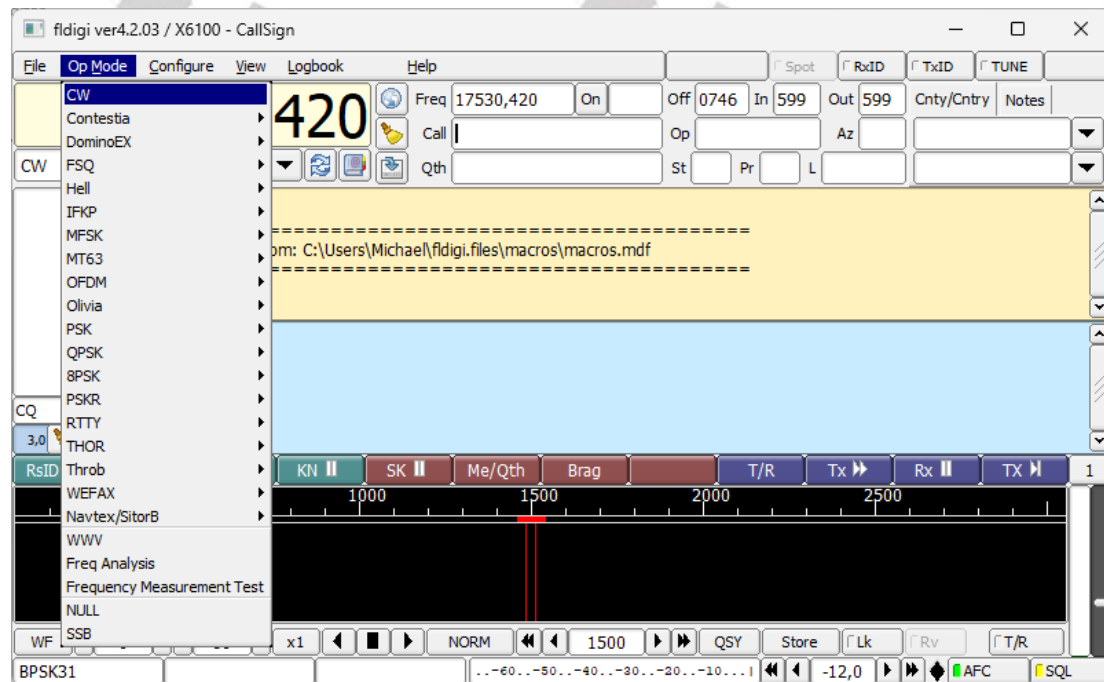

Fldigi is available for a variety of platforms, such as Linux™, OS X™, Windows™ and FreeBSD™.

<http://www.w1hkj.com/> and <https://sourceforge.net/projects/fldigi/>

Fldigi is OpenSource and continuously maintained by its developers W1HKJ & Associates.

16.1.6 Dimension 4

The successful operation of HF digital modes depends upon exact TX timing which is derived from the internal clock of your PC. Normally a PC would update its internal clock once a day. That is not sufficient for the described digital modes. That is, where Dimension 4 steps in. It is capable of more regular updates to the internal clock using SNTP (Simple Network Time Protocol) time sources within the internet.

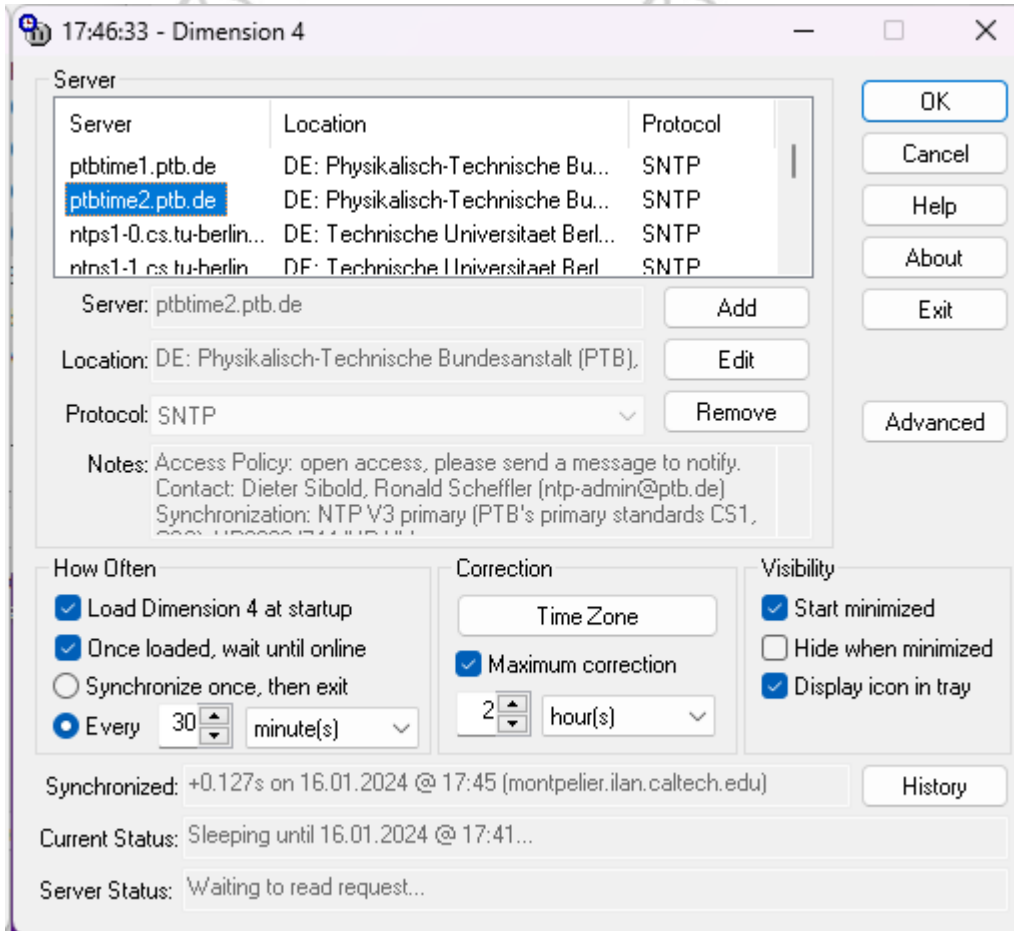

In the above example it is setup to synchronize the internal PC clock against ptbtime2.ptb.de every 30mins.

<http://www.thinkman.com/dimension4/>

Note: *It is of high importance that the PC's internal clock is really „in-sync“ with one of the listed high accuracy clocks,*

16.1.7 GridTracker

Digital modes do have a high focus on messages that are as short as possible. For example, FT8 does not transmit the city of the station but their locator. In order to get a better overview on the geographical location of stations, GridTracker is your way to go. Besides its excellent graphical output, it also automatically links to WSJT-X.

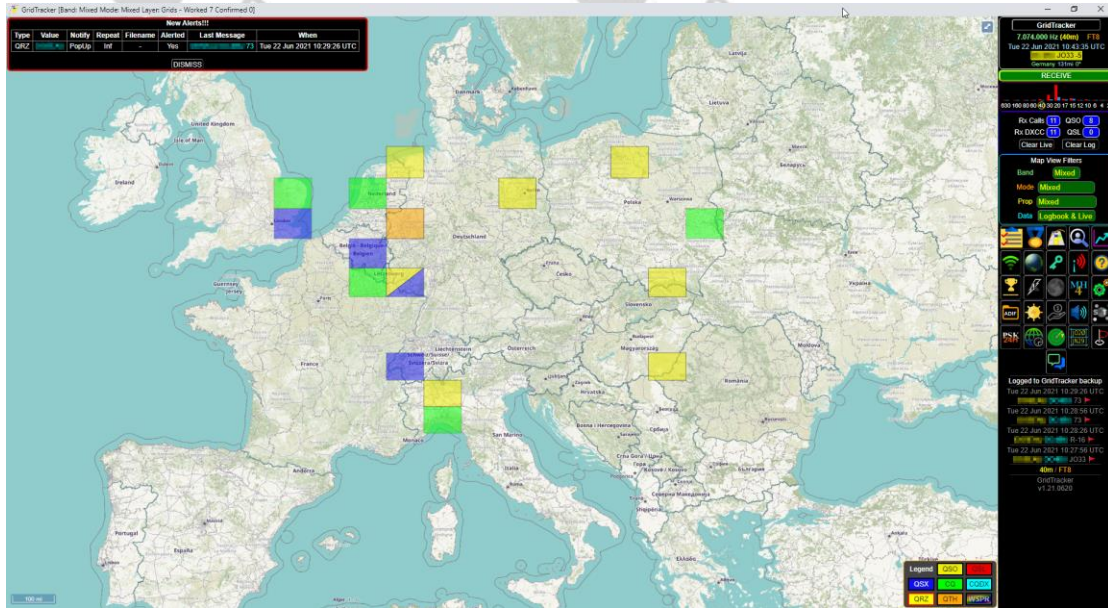

GridTracker is available for a variety of platforms, such as various Linux™ distributions, OS X™ and Windows™.

<https://gridtracker.org/>

16.2 Software for CAT control

There are quite a few programs out there that may be used with your Xiegu X6100. Some of them do support the Xiegu X6100 out of the box, others need to be set for G90 as those radio shares most of their command set for CI-V CAT control with the Xiegu X6100. The baud rate for CAT control of your Xiegu X6100 should be set to 19200.

16.2.1 Flrig

Frig is mainly a CAT control program that may be used as a standalone solution or in combination with other programs such as fldigi or WSJT-X. Its main purpose is to control your Xiegu X6100 via its DEV-Port and your PC.

<https://sourceforge.net/projects/fldigi/files/flrig/>

On first use of flrig your Xiegu X6100 might automatically go TX for a few seconds. Thus, make sure either a dummy load or a matched antenna is connected to your

Xiegu X6100. You then need to define the Transceiver settings to be used with flrig. In order to do so, select the 'Config' button in the top line of flrig, then move your mouse to 'Setup' and over to 'Transceiver'. Then click on your left mouse button to select that option.

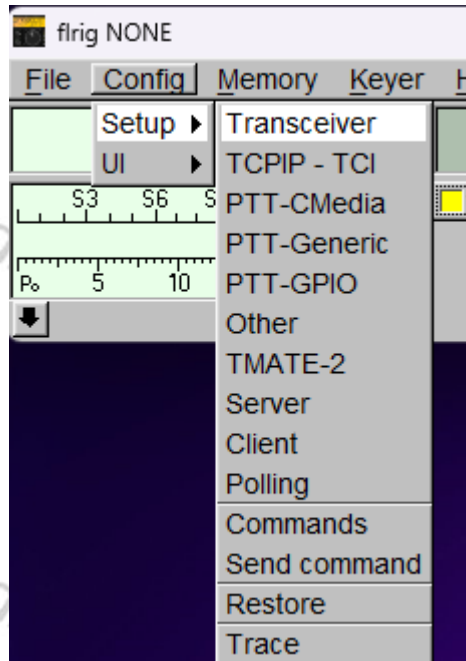

Now select 'Xiegu X6100' as your device (1), select the proper COM-port that the 'USB-Enhanced-SERIAL-B' virtual COM-port of your Xiegu X6100 DEV-port has been assigned to (2) and select a baud rate of 19200 (3). Leave the other parameters as shown in the below screenshot. Next click the 'Init' button (5).

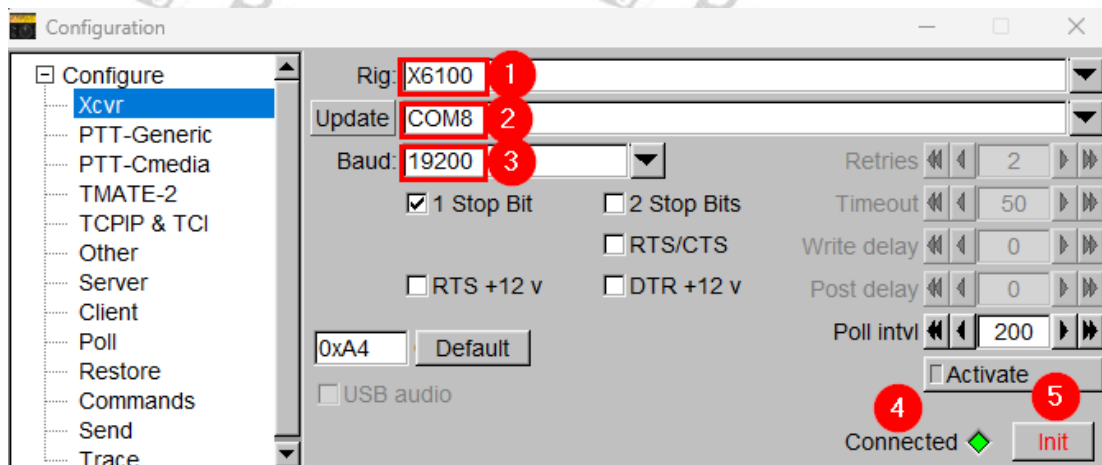

You will hear some noise of the solenoids inside the Xiegu X6100. After the initialization sequence has finished, the 'Init' label of the button (5) should no longer be printed in red, but black and the LED-indicator (4) should be colored green.

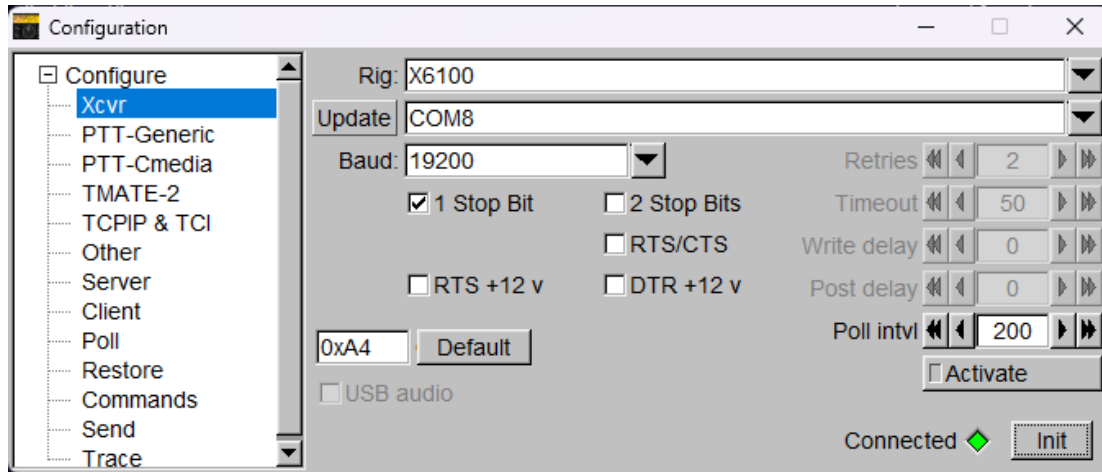

Your Xiegu X6100 is now successfully connected and you should see the very same data displayed within flrig as on the display of your Xiegu X6100.

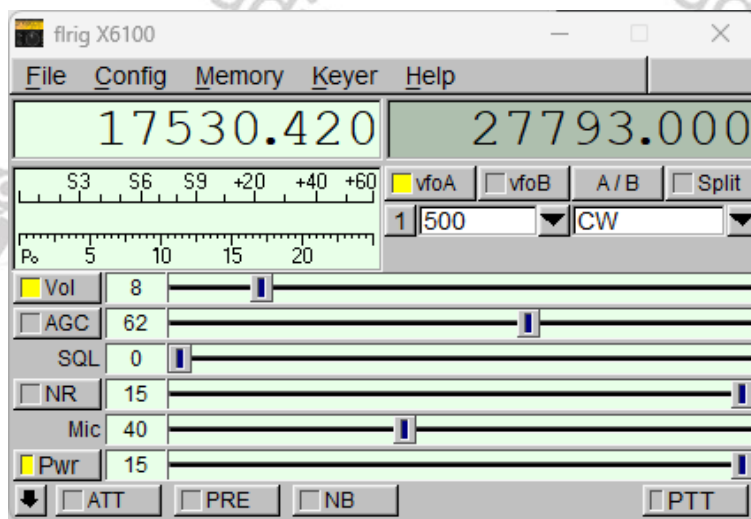

Whenever the Xiegu X6100 has not been implemented yet within a CAT control software you'd like to use, you may often select 'flrig' as radio and use the software with flrig as the connection bridge to your Xiegu X6100. This is a huge advantage of flrig.

Flrig and fldigi are both OpenSource and continuously maintained by its developers W1HKJ & Associates. Both software packages are free. However, you are asked to contribute to <http://www.gideons.org/> through their gift Bibles recognition program.

17 Technical data

Xiegu reserves the right to change the following technical data at any time and without further notice.

General

Frequency range	receiving: 0.5MHz~30MHz / 50.00~54MHz
Transmitting	1.8~2.0MHz / 3.5~3.9*MHz
	7.0~7.2*MHz / 10.1~10.15MHz
	14.0~14.35MHz / 18.068~18.168MHz
	21.0~21.45MHz / 24.89~24.99MHz
	28.0~29.7MHz / 50.00~54.00MHz
Working mode	CW, AM, SSB, NFM
Minimum stepping	1Hz
Antenna impedance	50Ω
Working temperature range	0°C~+55°C
Frequency stability	±1.5ppm within 10~30min after startup
	@25°C: 1ppm/hour
Supply voltage	9.0~15.0VDC, negative electrode grounding
Current consumption	receiving: 330mA@Max load
transmitting	3A@Max load
Dimensions	180*86*49mm (L*W*H) (not including protrusions)
Weight	about 880g (host only)

* 3.5 - 4 and 7-7.3MHz in US version of the radio

Transmitter

RF output power	10W (SSB/CW/FM) @13.8VDC
	2.5W (AM carrier wave) @13.8VDC
	5W (SSB/CW/FM) on battery power
	1.5W (AM carrier wave) on battery power
Spurious suppression	1.8~29.6MHz: ≥50dB
	50~54 MHz: ≥60dB
Carrier suppression	≥50dB
Microphone impedance	200~10k (600Ω in general)

Receiver

Circuit type	ZIF
Sideband suppression	≥50dB
MDS	-138dB

Sensitivity

Frequency band mode	SSB/CW	FM	AM
0.5~1.79999MHz	/	/	10uV
1.8~1.99999MHz	0.35uV	/	10uV
2.0~27.9999MHz	0.20uV	/	2uV
28.0~30.0MHz	0.20uV	0.22uV	2uV
50.0~54.0MHz	0.20uV	0.22uV	2uV

Audio output

Audio output	0.4W (8Ω, ≤10%THD)
Audio output impedance	4~16 Ω

Antenna tuner

Tuning range of antenna tuner VSWR	1:4.5
First tuning time	≤15s
Memory load tuning	≤0.2s

Wi-Fi/Bluetooth

Wireless LAN standard	IEEE802.11b/g/n
Authentication and encryption	WEP (64/128bit), WPA-PSK (TKIP), WPA2-PSK (AES)
Frequency band	2.4 GHz
Bluetooth version	4.0

- The above technical data are typical values and are subject to change without notice.
- The operating frequency range of the Xiegu X6100 varies depending on the version of the device. Ask your local dealer for details.
- When using the Xiegu X6100, please comply with the legal requirements applicable in your country.

18 Certifications

The Xiegu X6100 is certified according to FCC Rule Part 15B. It may also be sold in the European Community as it is compliant with European regulations. This is attested by the following certificates.

18.1 CE certificate for Xiegu X6100

Below you will find a copy of the CE certificate for the Xiegu X6100.

CERTIFICATE | CERTIFICATO | ZERTIFIKAT | CERTIFICADO | 證書 | 証明書 | 인증서입니다 | شهادة



CERTIFICATE

Certificate No: BGTCVYDX25112021

Applicant:	Chongqing Xiegu Technology Co., Ltd.
Name, address	7-6, Incubator Building, No. 256, Fangzheng Avenue, Shuitu High-tech Park, Beibei District, Chongqing, China
Manufacturer:	Chongqing Xiegu Technology Co., Ltd.
Name, address	7-6, Incubator Building, No. 256, Fangzheng Avenue, Shuitu High-tech Park, Beibei District, Chongqing, China
Product:	HF Radio Transceiver
Type / Models:	X6100
Trademark:	
Related Directives and Annex	Electromagnetic Compatibility Directive 2014/30/EU Radio Equipment Directive 2014/53/EU
Related Standards	ETSI EN 300 220-1 V2.4.1(2012-05), ETSI EN 300 220-2 V2.4.1(2012-05), EN 55032:2015+A11:2020, EN IEC 61000-3-2:2019, EN 61000-3-3:2013+A1-2019, EN 55035:2017
Technical file	TST202111Q3165-5ER, TST202111Q3165-2ER
Comments:	

This certificate is issued to the applicant on the basis of the information provided by the manufacturer or the applicant.

The CE mark can only be used under the responsibility of the manufacturer with the completion of EC Declaration of Conformity if all the relative EU Directives or Regulations are complied with. EC Declaration of Conformity and the technical documents are prepared by the manufacturer or its applicant who puts the product on the market.

The applicant or manufacturer should notify ECTI CERT on time in case any change to the above product is made. The applicant and the manufacturer should keep the technical file of the product for 10 years from the date of issue.



25.11.2021

Date of Issue



Manager

The validity of this certificate is 4 years from the date of issue.
Any alteration or duplication of this document in parts is subject to approval by ECTI CERT Ltd.

ECTI CERT Ltd.
 Bulgaria, Sofia, 133 Tsarigradsko Shosse Blvd.,
 www.ecti-bg.com

Tel.: +359 878 87 75 77
 E-mail: info@ecti-bg.com

18.2 FCC part 90 approval for Xiegu X6100

Below you will find a copy of the FCC Rule Part 15B approval for the Xiegu X6100.

TCB

**GRANT OF EQUIPMENT
AUTHORIZATION**

TCB

Certification
Issued Under the Authority of the
Federal Communications Commission
 By:

LGAI Technological Center S.A. (APPLUS)
 Ronda de la Font del Carme, s/n
P.O.
 Box 08193,
 Barcelona,
 Spain

Date of Grant: 12/22/2021

Application Dated: 12/22/2021

Chongqing Xiegu Technology Co.,Ltd.
 7-6, Incubator Building, Shuitu High-tech Park,
 Beibei District, Chongqing, China
 Chongqing,
 China

Attention: Mu Lianzheng

NOT TRANSFERABLE

EQUIPMENT AUTHORIZATION is hereby issued to the named GRANTEE, and is VALID ONLY for the equipment identified hereon for use under the Commission's Rules and Regulations listed below.

FCC IDENTIFIER: 2ANLH-X6100
 Name of Grantee: Chongqing Xiegu Technology Co.,Ltd.
 Equipment Class: Part 15 Class B Digital Device
 Notes: Shortwave transceiver

Grant Notes

FCC Rule Parts
 15B

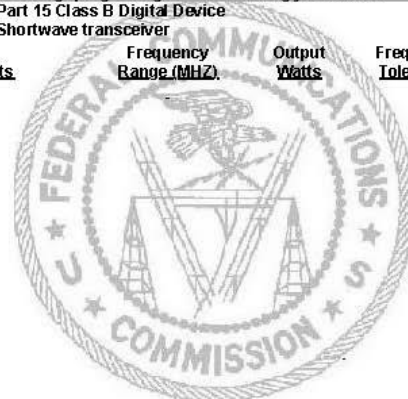



Frequency
Range (MHZ)

Output
Watts

Frequency
Tolerance

Emission
Designator

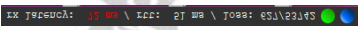
19 Common issues and their solution

Issue	Solution
<p>If the Wi-Fi signal is too weak, there may be delays in the Wi-Fi signal runtimes when using WFVIEW.</p> 	<p>Make sure that the Xiegu X6100 is located as close as possible to a Wi-Fi access point or is connected to the home network via a LAN adapter connected to the HOST port of the Xiegu X6100.</p>
<p>What is the polarity of the supplied power supply cable?</p>	<p>The 5525 plug has +12V on the inside and GND on the outside. The white wire of the mains connection cable supplied is +12V. The other side, which is fitted with a piece of black shrink tubing, is GND.</p>
<p>How can the CAT control of the Xiegu X6100 be used?</p> 	<p>To do this, plug the supplied USB-A to USB-C cable into the USB-C socket labeled 'DEV' on the right-hand side of the Xiegu X6100. Plug the USB-A side of the cable into a corresponding socket on your PC.</p>
<p>Can the Xiegu X6100 remain permanently connected to an external charger or an external DC power supply while the charging function ([GEN] → RADIO SETTING1 → CHARGER) is switched off?</p>	<p>Yes, this is possible. The green LED also lights up when switched off, provided that the 'CHARGER' parameter has not previously been switched off in the 'RADIO SETTING1' submenu.</p>
<p>Can or should the X6100 be operated from an external power source when the charging function is switched off?</p> 	<p>Yes, as long as the 'CHARGER' parameter has previously been switched off in the 'RADIO SETTING1' submenu, operation with an external power supply unit is unproblematic. The power supply unit should be able to supply a current of at least 3.4 amps at an output voltage of 13.8V DC. The Xiegu X6100 works from 9 to 15 volts DC, whereby the current consumption increases at a lower voltage than 13.8 VDC and is reduced at more than 13.8 VDC (up to a maximum of 15 volts DC).</p>

Issue	Solution
When should the charging function be switched off?	<p>The charger should be used when the radio is switched off. The battery management system (BMS) starts with a constant current charge, which is indicated by a flashing green LED. If the current consumption of the battery falls below a defined target value, the voltage is kept constant up to the point when the battery is fully charged. During this state of charge, the green LED lights up constantly. During this charging state, the two Lilon cells should be evenly charged to their maximum voltage of 4.2 VDC. The LED should (theoretically) turn off when this state is complete, but there may be a conflict between the actual indication of completed charging and the LED remaining on as a reminder that the charger is still connected. We therefore recommend charging overnight with the supplied charger and then switching it OFF again via [GEN] → RADIO SETTING1 → CHARGER.</p>
When should the charging function be switched on?	<p>The BMS monitors the battery capacity and voltage. It has a voltage setpoint value to initially deactivate the transmission capability and a second setpoint value to switch off the radio. This ensures that the battery is not deeply discharged, which would prevent it from being recharged. At this point, the charger should be activated. During the first 4 charge/discharge cycles, you should fully charge the battery and allow the radio to discharge the battery by switching on reception mode until the BMS switches it off. After this, the battery will have reached its rated capacity and will be more tolerant of partial charge cycles to complete a charge before the radio's BMS switches the battery off. The battery has a maximum number of charge/discharge cycles, so partial charges should be avoided where possible.</p>

Issue	Solution
Does operating the Xiegu X6100 on an external power source affect the internal batteries of the Xiegu X6100 when the charging function is switched off?	There should be no effect on the battery if the charging function is switched off, which is indicated by the absence of green LED activity.
Should the charging function be switched on or off to increase the output power when the Xiegu X6100 is operated via an external power supply?	The charging function should always be switched off when the radio is in operation, even if it is only used for reception. If the battery is under load, the BMS cannot detect a reduction in power consumption. When operating without the squelch switched on or when transmitting, the BMS only detects an increase in power consumption. This can lead to excessive heating if the heat from the internal components of the power amplifier (PA) is combined with the heat from the combination of the BMS circuit and battery pack. The radio operates with passive cooling (no fan). The surface of the outer housing is able to dissipate the heat generated during normal operation. However, constant or near-constant carrier modes such as FT8 (or other digital sound card modes) as well as CW and RTTY place a significantly greater load on the PA part of the radio. This results in significantly higher heating. If you add the additional heat generated by the charging circuit, the heat can become too great. If this is combined with working in direct or almost direct sunlight, the radio may be damaged.
What does the symbol  in the top left-hand corner of the LCD mean?	The transmission frequency range of your Xiegu X6100 has been extended. This change has not been approved by the manufacturer.
Why is there a black sticker on the left side of the Xiegu X6100?	Below the sticker there is a recess in the metal side panel as the Bluetooth/Wi-Fi antenna of the Xiegu X6100 is located directly behind it.

Issue	Solution
The large VFO rotary knob is very stiff.	Carefully remove the rubber ring from the VFO rotary knob. Then loosen the 1.5 mm hexagon socket screw on the VFO rotary knob and raise it slightly before tightening the hexagon socket screw again and refitting the rubber ring.
The battery does not get charged	Please check if the option CHARGER within RADIO SETTING1 is turned ON.
The output power of the Xiegu X6100 is 0 watts. Is the Xiegu X6100 defective?	<ul style="list-style-type: none"> • Verify the Red TX light is on when keying the Mic or transmitting via computer control. • Check the output power using the NFM mode. • Check setting of TX POWER in the RADIO SETTING1 Menu. • If using SSB Voice, check the I-MIC GAIN / H-MIC GAIN setting (depending on the microphone you do use) in the RADIO SETTING1 Menu. • Verify that Split operation (SPL) has not been enabled and forcing the transmit frequency to be out of band. • If running a soundcard digital mode, verify that the mode is set to U-DIG to route audio into and out of the radio.
When pressing the UPGRADE button, the Xiegu X6100 powers down and the screen goes blank.	Plug in the supplied power supply to power the Xiegu X6100 during upgrade process. When upgrading the firmware of the Xiegu X6100, it needs to be connected to the power supply to complete the process.

20 Where to find further information?

On the Internet you will find a variety of sources with information about the Xiegu X6100. When watching videos make sure that the Xiegu X6100 in the video is at the same firmware level as yours (features can change and bugs may be fixed between firmware versions).

20.1 Radioddity support area

Please note that you can find all firmware, software and user manuals in the support section of our official Radioddity website by following these steps:







<https://www.radioddity.com/> → Support → Xiegu → X6100

For the Xiegu X6100, the resulting support page looks something like this:

MANUALS & SOFTWARE

Here you will find user manuals, device drivers and softwares for a wide range of our products.

Software

-  Firmware_Upgrade_20230831 [fix CAT] ↓
-  Firmware_Upgrade_20230831 [with wfview Guide] ↓
-  Xiegu_X6100_Firmware_Upgrade_20221124 ↓
-  Xiegu_X6100_Firmware_Upgrade_20221104 ↓
-  Xiegu_X6100_Firmware_Upgrade_20220418 ↓
-  Xiegu_X6100_Firmware_Upgrade_20220219 ↓
-  Xiegu X6100 Cable Driver ↓

As soon as a new file is available (e.g., firmware updates, updated manuals or others), these files will be published in our support area.

Note: The list of 'manuals' can be found below the 'Software' section. Use the scroll bar to navigate.

20.2 Xiegu-X6100 group on groups.io

All users of the Xiegu X6100 also find valuable help via the corresponding Xiegu X6100 group within groups.io. Visit <https://groups.io/g/xiegu-x6100> to join the Xiegu-X6100 group with its more than 1000 members.

We would like to thank all Radioddity customers for their constructive feedback.

If you find an error in the firmware of the Xiegu X6100 or in this documentation, or if you miss a function that you would have expected, or even if a detail has not been described to the expected extent, please feel free to write a message to support@radioddity.com. In general, firmware updates for your Xiegu X6100 are free of charge. The use of non-Xiegu firmware for this radio may invalidate the warranty.



Thank you for shopping at Radioddity!

TUTORIALS, SUPPORT AND MORE CAN BE FOUND AT:



<https://www.radioddity.com/>



<https://www.facebook.com/radioddity>



<https://www.youtube.com/c/Radioddityradio>