

X6200

HF/50MHz Ultra-Portable Transceiver

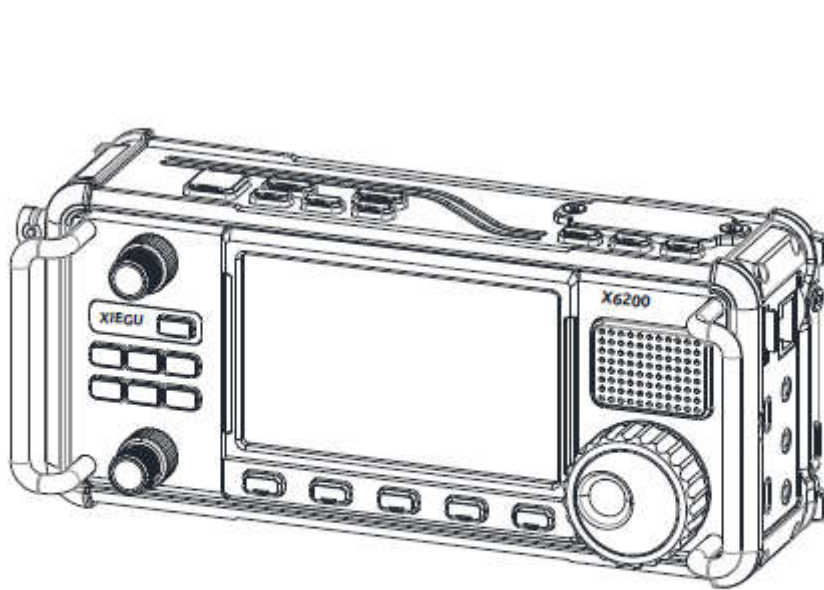

User Manual

V0.1

Approval Code: XXXXXXXXXXXX

Dongguan Weisheng Communication Technology Co., Ltd.

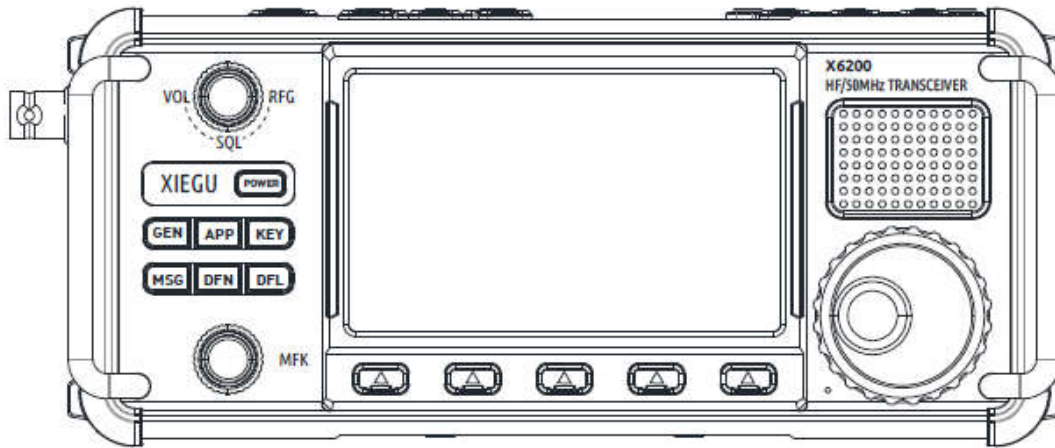

X6200 uses a high-performance DRFS architecture and is equipped with a powerful baseband and RF unit, bringing amateur radio enthusiasts a brand new strong function and more convenient user experience. The new platform architecture provides transceivers with higher receiver sensitivity and lower noise coefficient, allowing for clearer reception of signals from different locations.

In addition, X6200 possesses all the characteristics of a super portable device, making it easy to carry outdoors or while traveling. Its compact design and portability allow users to listen to their favorite signals at any time and any place, making the use of transceivers freer and more flexible.

- Adopt RF direct sampling technology
- HF/50MHZ full mode (supporting data communication)
- WFM broadcast reception, aviation band reception
- Support remote control
- Built-in automatic antenna tuner
- Integrated multi-mode modem, preset message, audio automatic call
- USB interface supports one-line data transmission, control, and automatic reporting to the computer

We recommend you to read through this Manual to rapidly keep abreast of the operation & control method of the X6200 before using it.

- To carry out effective transmission, it is necessary to obtain the corresponding amateur radio operation qualification and apply for the station setup license.
- Transmission activities shall not be carried out in non-amateur frequency bands.

On/Off prompt!

The startup and shutdown operations of X6200 require some time, please read the following startup and shutdown instructions carefully and pay attention to the operating methods:

Startup:

Short press the power switch button until the logo light turns green, then release the power button and wait for the system to start up.

Shutdown:

Hold down the power switch button until the display exits, then release the power button.

Attention:

- It is recommended to wait for more than 30s between shutdown and startup.
- Please perform the correct shutdown operation and do not forcibly power off to avoid damage to the internal memory.

CONTENTS

Precautions

Safety precautions	6
Operation permit	6
Battery precautions	7
Important tips	7
Electromagnetic interference	8

Panel Instructions

Front panel	8
Right side	9
Left side	9
Top button	9
Hand microphone button	10

Interface Definitions

Connection of KEY Port	11
Power supply wiring	11
Charging	12
Operation of MFK knob	13
Select language	13
Function description of each area on the main interface	14

Basic Operation

Turn on/off radio	15
Adjust audio volume	15
Operating frequency band and mode selection	15
Set operation frequency	16
Adjustment of RF gain and muting level	16
SSB/AM/NFM mode transmission	17
Transmit in CW mode	17
Automatic Antenna Tuner	18
Use the radio PPT key for transmission	18
Lock button	19

Menu Operation

Basic operating methods:	19
GEN function operation	19
SYSTEM menu	21
MEMORY menu	22
APP function operation	23
Automatic Sending of Preset Information under MODEM	24
SWR SCAN standing wave scanner operation	25
FT8 DECODE	25
Recording automatic call	26
KEY function operation	26
MSG function operation	27
Voice recording	29

DFN function operation	30
DFL function operation	30
Set time/View system information/Update firmware/Restore factory settings	32
Set wireless network parameters	33
Set Bluetooth function	34
Forced shutdown	35
Appendixes	
Appendix 1 Connection between X6200 and XPA125B (L4001 Cable)	35
Appendix 2 Connection between X6200 and Computer for Data Communication & Control	36
Appendix 3 Setting Method for Remote Control of WFSERVER Radio Station End	37
Parameters	
Packing List	39

Safety precautions

- Do not use this device in lightning weather. Disconnect the power supply and antenna in advance.
- Do not touch the antenna during the transmission of the device.
- Do not apply AC power to the DC interface on the side panel of transceiver. Otherwise it may cause fire or damages to the device.
- Do not apply more than 15VDC voltage to the DC interface on the side panel of transceiver. Otherwise it may cause fire or damages to the device.
- Do not reverse the polarity of the power cable. Otherwise it may cause fire or damages to the device.
- Do not operate or touch the device with wet hands. Otherwise it may cause electric shock or damages to the device.
- In case of smoke or peculiar smell, cut off the power supply immediately, remove the power cable, and then contact the supplier.
- Do not use the device in areas, vehicles or aircraft where it is prohibited.
- Do not use this device while driving or operating engineering equipment.
- Do not use the device in petrol stations, gas stations or the place with combustible gas around.
- Do not use the device in hospitals or in an environment where people wear medical devices.
- Do not expose the device to rain, snow or any liquid. Otherwise it may cause damages to the device.
- Do not use headphones at high volume.
- Do not disassemble or modify the device.
- Do not place the device near the heat source or in direct sunlight.
- Do not place the device in a dusty or damp place.
- Do not place the device in a poorly ventilated place and do not block any radiator on the device. Otherwise, the device may be damaged due to overheating.
- Do not wipe the device with organic solvents, such as benzene or alcohol. This may damage the surface of the equipment.
- Do not apply impact force to this device, especially to the front where the battery is located. Otherwise it may cause fire or damages to the device.
- Do not place the device in the area with temperature range beyond $-10^{\circ}\text{C}\sim+50^{\circ}\text{C}$ for storage or use.
- Cut off the power supply, take out the battery panel, and remove the external power cable if the device is not used for a long time.

Operation permit

- Make sure you have had legal and valid operating certificates or permissions issued by local government departments before making a call on the frequency band of amateur radio.

Battery precautions

This device contains lithium-ion battery components, so improper use may result in dangers such as smoke, fire or battery rupture.

- The battery panel is installed on the back of the device. **Do not hit the battery panel of the device.**
- Do not place the device in a place where the temperature is higher than 50°C; otherwise, the battery pack may rupture or catch fire.
- Do not place the back of the device near heat sources, such as stove fire or direct sunlight.
- Do not weld, disassemble or modify battery components by your won. This can lead to protection failure and battery damage, which can further lead to fire and other hazards.
- In case of obvious deformation, seepage or peculiar smell at the installation place of the battery pack, the device shall not be further used, and distributor shall be contacted immediately for assistance.
- Do not use the device beyond its temperature range; otherwise, the service life of the device and battery pack may be reduced or damaged.
- Do not leave the battery pack in fully charged or fully discharged state for a long time. Otherwise, the service life of battery pack will be shortened. Please maintain the electric quantity of battery pack within 40%~50% if the device is to be left unused for a long time, and then keep it properly.
- The service life of the battery pack is about 2 years generally. Please replace the battery pack once its service life reaches this period. Even if the battery still works, its performance will be significantly reduced and service time will be greatly shortened. The battery pack can be generally charged and discharged for around 300 times. This depends on specific usage conditions.
- Do not charge the device with other non-compliant chargers.
- Pay attention to the condition of the device when charging. If any abnormalities occur, please stop charging immediately and remove the battery panel in a safe place.
- Do not charge the device in vehicles under direct sunlight.

Important tips

- Make sure the antenna feed system meets the transmitting requirements before actual transmitting.
- The device may be extremely hot after continuous and long-term transmitting (such as FT8 operation). Please appropriately extend transmitting interval and strengthen external heat dissipation and ventilation.
- Please place the device in a safe and reliable place and keep it away from children

or unauthorized persons.

Electromagnetic interference

It shall be noted when using wireless LAN or Bluetooth devices that when other wireless devices, such as wireless mouse, wireless keyboard and wireless router, work in the same frequency band, they may interfere with each other, resulting in unstable or interrupted connection of the device. In such case, please keep away from other devices or stop using those devices.

I. Panel Instructions

Front panel

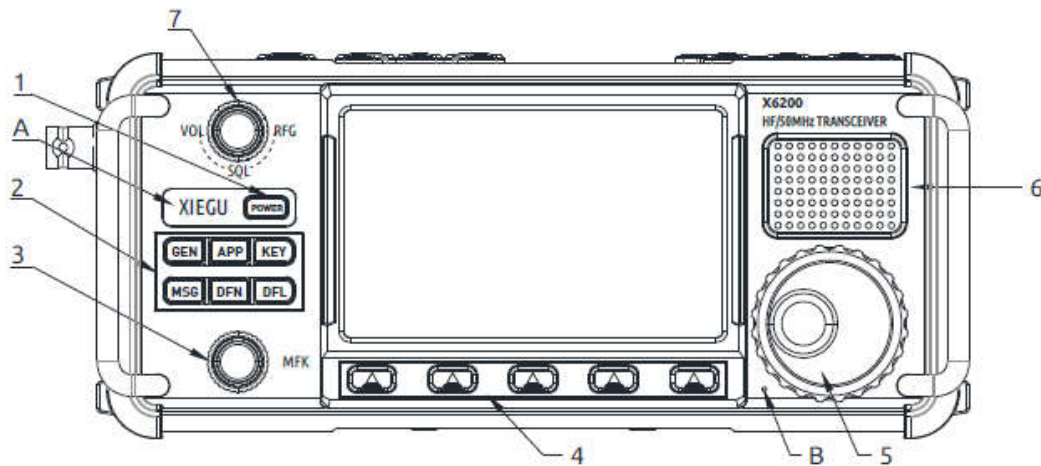

1 Power button

Press and hold it to turn on the power supply of transceiver.

Press and hold for 1s to turn off the transceiver power.

2 Function button area

GEN button

Press it to bring up the general settings menu.

APP button

Press it to bring up function menu.

KEY button

Press it to bring up taper settings menu.

MSG button

Press it to bring up information editing and storage interface.

DFN button

Press it to bring up the menu of digital functions.

DFL button

Press it to bring up digital filter settings interface.

3 MFK multi-function knob

Inner circle: adjust frequency (default)

4 Multi-function buttons

Press it to execute functions displayed on screen

5 Main knob

Rotate it to adjust frequency

6 Speaker

7 VOL/SQL/RFG knob

Default: volume control.

Press the knob to adjust SQL muting depth.

Press the knob again to adjust RFG gain.

A Power/transmit indicator light

The indicator light is green after startup

When the transceiver is in transmitting state, the indicator light is red.

B Built-in MIC speaker hole

Outer circle: adjust power (default)

Right side

8 CARD

microSD memory card slot.

9 DEV

USB port. Accessory interface

10 HOST

USB port. Host interface.

11 MIC

Hand microphone interface. The interface is of type RJ45.

12 ACC

It is a 3.5mm stereo interface. See page 8 for interface definitions

13 KEY

It is a 3.5mm stereo interface used to connect manual/auto tapper. See page 8 for connection

14 S/P

External speaker/headphone interface, with speaker or headphone output can be set via menu. It is a 3.5mm stereo interface achieving stereo output.

Note: short circuit or silence will be caused if plugging the single track plug externally.

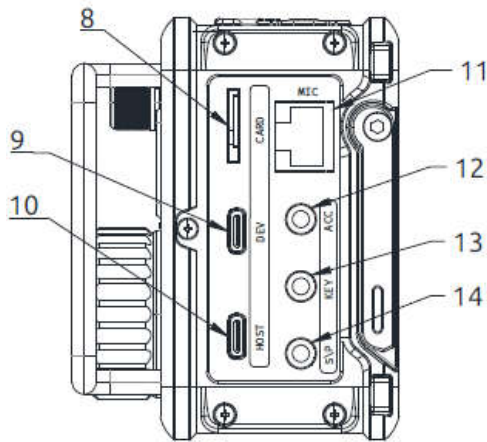

Left side

15 ANT

BNC interface, 50Ω, for antenna connection.

16 DC IN

External power input/charging port, 5525 type.

Note: input voltage shall not be higher than 15V DC.

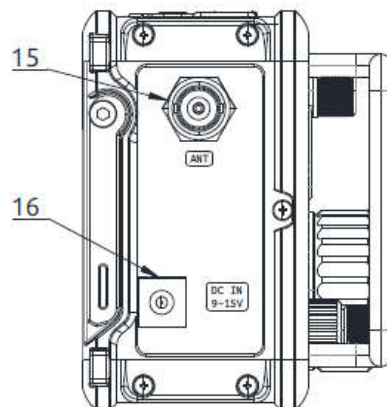

Top button

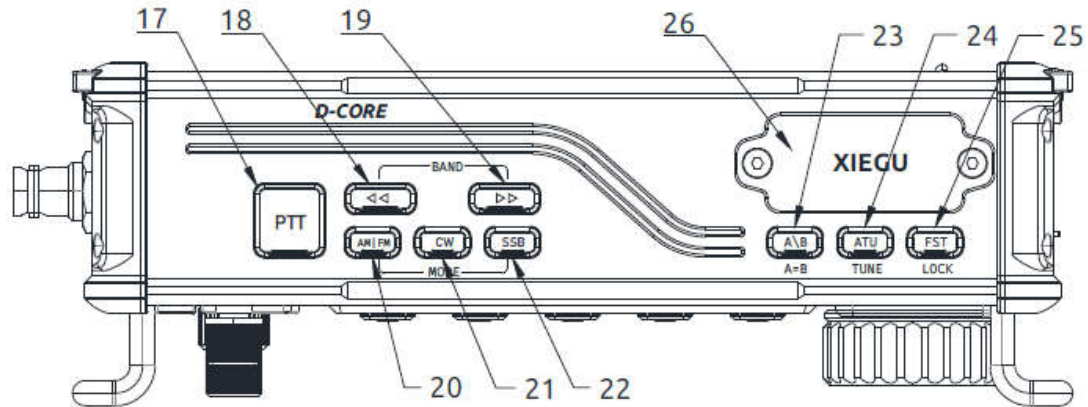

- | | |
|---|--|
| 17 PTT
PTT button on device body. | 23 A/B
Short press: VFOA-VFOB switch button.
Long press: Set VFOA and VFOB to the same parameters. |
| 18/19 Left and right switch
Frequency band/channel increase and decrease switch. | 24 ATU key
Short press: Open the built-in antenna tuner.
Long press: Start the antenna tuner for tuning. |
| 20 AM FM
AM/NFM mode switch button. | 25 FST
Short press: Fast step selection button.
Long press: Lock the buttons and knobs. |
| 21 CW
CW mode switch button. | 26 Expansion component installation position |
| 22 SSB
SSB mode switch button. | |

Hand microphone button

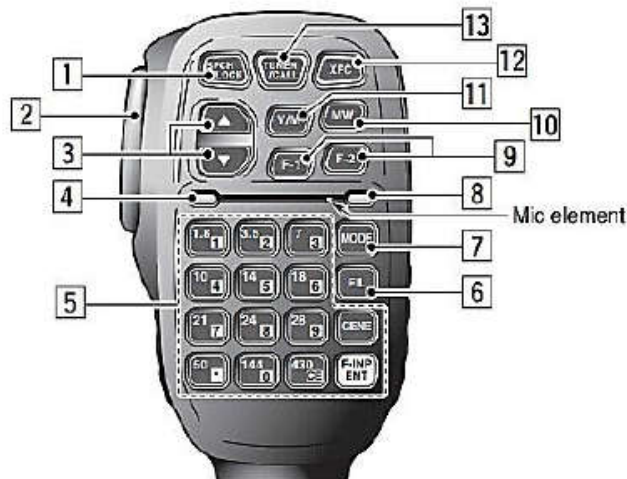

- | | |
|--------------------------------|---|
| 1. SPCH/LOCK button | Short press to lock/unlock the larger impeller |
| 2. PTT button | Transmitting control button |
| 3. Up/down | Frequency step +/- under VFO mode; previous/ next channel |
| 4. Transceiver indicator light | Hand microphone operation indicator light |
| 5. Figure button area | Waveband direct access/numeric keyboard area |
| 6. FIL button | Filter selection |
| 7. MODE button | Selection of working mode of host |
| 8. Functional indicator light | Button action indication
Custom functions can be set in SETTING2 |

- | | |
|------------------|--|
| 9. F1/F2 | Short press to save VFO to the current channel number |
| 10. MW button | Short press to switch the VFO/MEMO mode |
| 11. V/M button | Short press to switch VFOA/B; long press to copy VFO |
| 12. XFC button | from foreground to background |
| 13. TUNER button | Short press to switch on/disconnect automatic antenna tuner;
long press to enable automatic antenna tuner |

Interface Definitions

Microphone port

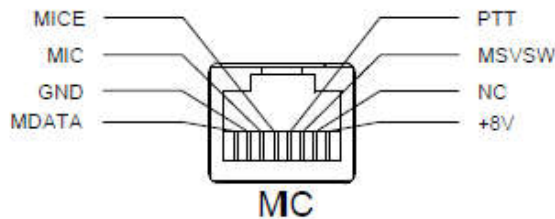

Definition of ACC interface

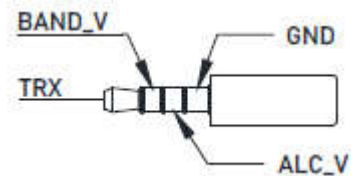

Connection of S/P Port

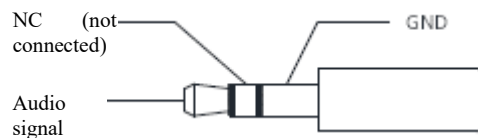

Connection of KEY Port-----

Connect manual/automatic tapper according to the schematic diagram shown in the right figure.

Attention:

- If the connector of the manual tapper is a 6.5mm 2-core plug, please change it to a 3-core 3.5mm stereo plug according to the wiring method shown in the right figure, and connect the trigger end of the electric key to the "Di" or "Da" terminal.
- Take care that direct use of the 2-pole to 3-pole adapter or incorrect wiring may result the radio in CW transmission status all the time.

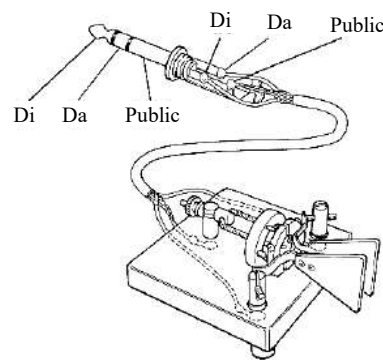

- ◆ Using plugs of other specifications may damage the socket.
- ◆ X6200 may switch to transmitting mode if plugging in or unplugging the tapper plug when it is working.
- ◆ Please cut off the power supply of X6200 before connecting or disconnecting the tapper.

Power supply wiring

9~15V external **DC power supply** can be used for X6200. The current load capacity of DC power supply shall be at least 3.5A. Attached power lines can be used to

connect to radio and DC power supply.

DC power supply shall be connected in strict accordance with following figure to avoid reverse polarity connection.

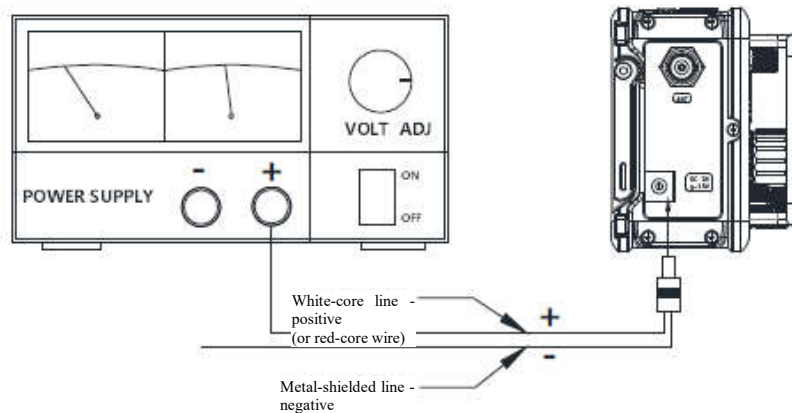

- When using an external power supply, in order to improve anti-interference capability, an EMC magnetic ring can be placed on the power line near the radio.
- When using an external power supply, because the charging unit inside the radio needs to be managed, there will be a current consumption of about 100mA when the device is turned off. This consumption does not exist when only powered by the battery.

Charging

When the inside of the battery symbol is empty and the color is red, it means that the battery is not installed or the battery is depleted.

Please use the accompanying charging adapter to charge the X6200 transceiver. Insert the AC terminal of the charging adapter into the mains power supply and the output terminal into the DC interface on the left side of the X6200, and then turn on the charging switch in the menu of SETTING 1 to charge the internal battery. The charging process shall be kept continuous until the charging instruction indicates it has been completed. The power platform will automatically stop charging once the charge is completed. It is recommended to charge when the device is turned off.

During shutdown and charging, the TR indicator light is used to indicate the charging status. The indications for each status are as follows:

- a. Green light flashing: the charging is in progress.
 - b. The green light is always on: the battery is full.
 - c. Off: once the charging option is disabled in the menu, the indicator light will not be off.
 - d. Red light flashing: the battery is abnormal. At this time, unplug the charger, check if the battery is installed correctly, or reinstall the battery.
- ◆ When the temperature is below -10°C , the device will automatically disable the charging function to protect the battery.

Attention!

- Polarity of power lines shall be carefully inspected to avoid reverse polarity connection when external power supply is adopted.
- Reverse connection of power may cause severe damage to the radio.
- Do not charge the radio with any other charger that does not meet the specifications. Otherwise, the device may be damaged.

Tips!

- ◆ The charging adapter can only charge the X6200 and cannot be used for transmitting as there is a risk of damaging the device.
- ◆ Under no circumstances shall the **DC port on the left of the X6200 be connected to a voltage higher than 15VDC**. Otherwise, serious device damage may occur.

Operation of MFK knob

1. The MFK knob is divided into an inner circle and an outer circle. When the inner circle and outer circle rotate by 2 steps each, the device operates one time.

2. The functions of the inner circle and outer circle of the MFK knob vary in different interfaces.

- In the main interface:
 Inner circle function: adjust frequency.
 Outer circle function: adjust power.
- In the menu page:
 Inner circle function: adjust the parameters of the currently selected item.
 Outer circle function: select different function options.

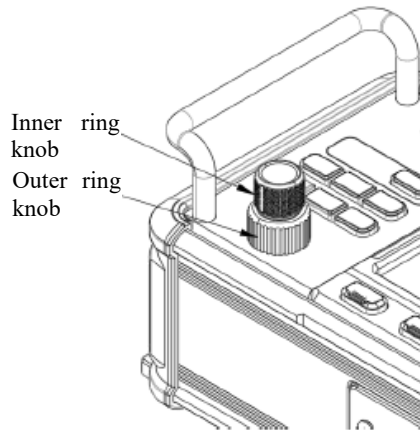

Select language

The display interface of X6200 supports Chinese and English languages, and users can choose the corresponding language according to their needs.

Set methods:

1. The default startup interface is English. Press [SYSTEM] key in a short time to enter the system setting.
2. Rotate the outer circle of MFK, select [Language Settings], press the MFK button to enter the language selection interface, as shown in the following figure:

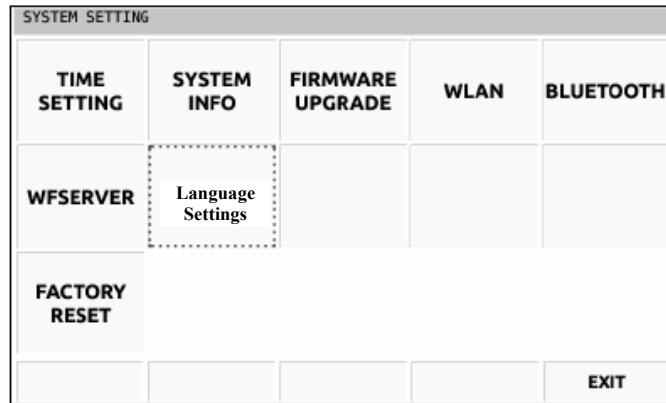

1. Rotate the inner circle of MFK, select the desired language, press the corresponding [OK] button at the bottom of the screen to complete the setting, and press [EXIT] to exit the current interface. As shown in the figure below:

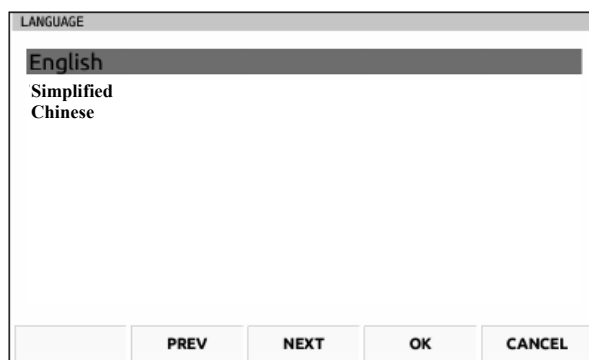

Function description of each area on the main interface

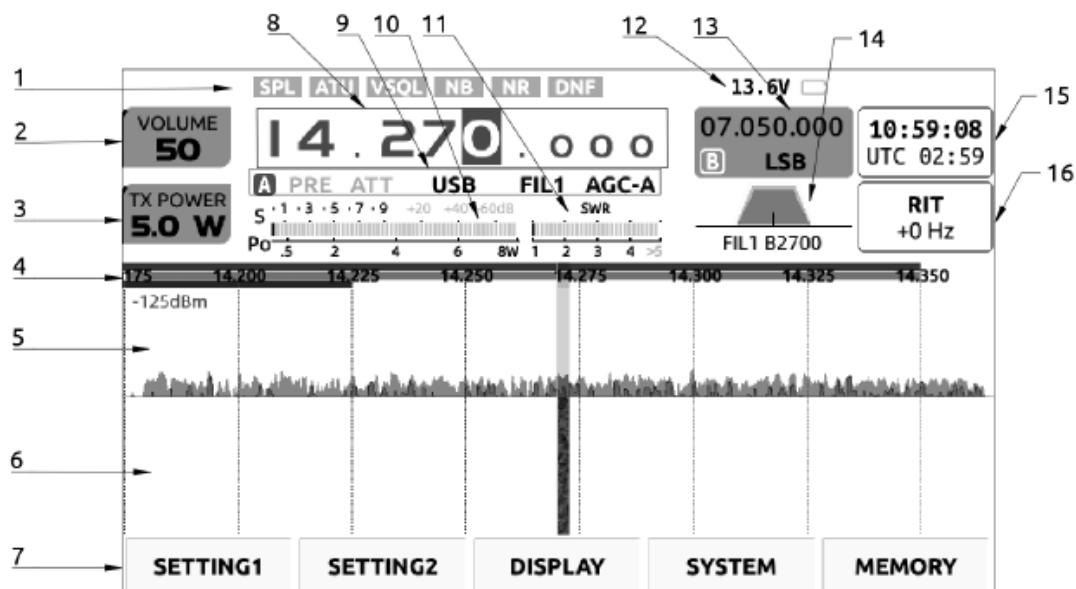

- | | |
|---|--|
| 1. Status display area 1
This area displays SPL, ATU, SQL, NB, NR and DNF switch status. | 9. Status display area 2
This area displays PRE/ATT/mode /AGC status |
| 2. Volume label
Display volume/noise level/RF gain | 10. Meter header display area 1
This area displays the S meter and transmission power meter |

- Short press the volume knob to switch the above three status.
3. Multi-function quick tags
The figure shows the transmitting power adjustment tag. Items of the tag displayed can be rapidly set via menu.
 4. Amateur band map display area
 5. Spectrum display area
 6. Waterfall diagram display area
 7. Multi-function menu area
Short press the corresponding button at the bottom of the screen to operate corresponding functions.
 8. Main VFO frequency display area
 11. Meter header display area 2
This area displays the emission standing wave meter
 12. Meter header display area 3
This area displays information such as LAN/battery.
The current displayed value is the external voltage.
 13. VFOB parameter display area
 14. Filter parameter display area
 15. Time display area
 16. RIT parameter display area

Basic Operation

Turn on/off radio

Operation method:

1. Press the power button until the XIEGU icon is displayed on the screen. Release the power button and wait for the system to start up.
2. Press the power button until the screen turns black and there is no display. Release the power button at this time, and the system is still in the shutdown process. Do not perform any other operations or forcibly power off. It will take about 10s for the X6200 to turn off

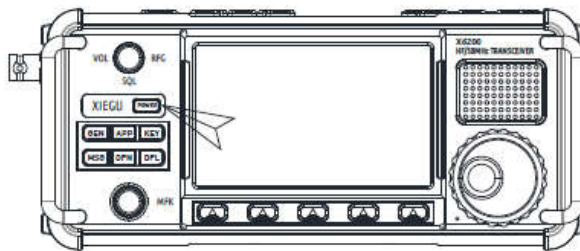

Adjust audio volume

Operation method:

1. Turn the volume knob to the left or right to adjust the output volume.
2. Short press the volume knob to switch volume/muting depth/RF gain adjustment.

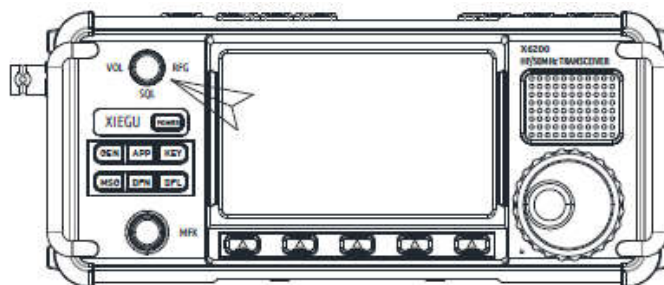

Operating frequency band and mode selection

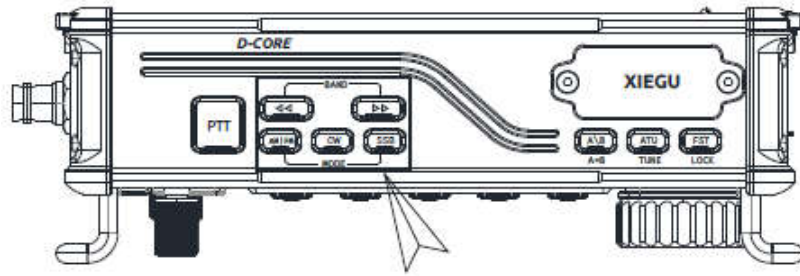

Operation method:

1. Press the corresponding mode button at the top of the radio to switch to corresponding mode.
2. Press left or right [←][→] button to orderly switch operation frequency band:
 1.8MHz ↔ 3.5MHz ↔ 7MHz ↔ 10MHz ↔ 14MHz ↔ 18MHz↔.....
 21MHz ↔ 24MHz ↔ 28MHz ↔ 50MHz ↔ WFM frequency band ↔ aviation frequency band
3. Figure buttons on hand microphone can be used to directly switch to corresponding amateur band.

Set operation frequency

Operation method:

1. Rotate large knob to set the frequency. Clockwise rotate the knob to increase the operating frequency and anticlockwise rotate the knob to decrease the operating frequency.
2. Press the top [FST] button to change the frequency adjustment position for fast adjustment.

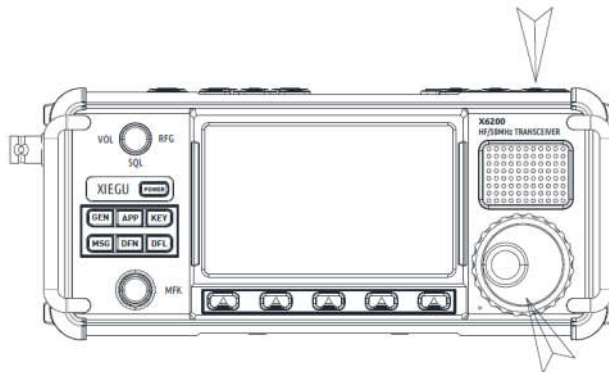

3. Set frequency by multi-function hand microphone:
 - a. Press [F-INP ENT] key on hand microphone, and the X6200 will be in frequency setting state, and cursor will be flickering at the first place on the left of frequency display position;
 - b. Input expected frequency values one by one, and press [F-INP ENT] key again to complete the frequency setting.

For example, press buttons in following sequence to set current frequency as 14.25000MHz:

1. Press [F-INP ENT] firstly;
2. Press 1, 4, 2, 5, 0, 0 and 0 number keys one by one;
3. Press [F-INP ENT] key again to complete the setting.

Adjustment of RF gain and muting level

Proper RF gain can facilitate to improve the quality of signal received. In general, appropriately reducing the RF gain value at some low-frequency ranges with strong interference can significantly improve the receiving effect.

Adjustment methods of RF gain:

1. Short press the volume knob continuously to bring up the RF GAIN setting items. The tag on the left side of the screen will display RF GAIN.
2. Rotate the volume knob to adjust the RF gain value.

SQL tuning method:

When muting is necessary for signals or noise less than a certain amplitudes, appropriate muting level can be set to disable the audio switch without signal so that the speaker can be muted.

1. Short press the volume knob continuously to bring up the RF GAIN setting items. The tag on the left side of the screen will display SQL Level.
2. Rotate the volume knob to set the muting level. At the same time, the muting grade will display on the screen.
 - The muting grade gradually strengthens from S1 ~S9, corresponding to strength of S meter. For example, when the muting grade is set to be S3, it indicates that the speaker will sound when the signal strength is more than S3. Otherwise, the speaker will in the silent mode.

SSB/AM/NFM mode transmission

Operation method:

1. Press the PTT button on the microphone to start transmitting. Please speak to the microphone in a normal voice.
2. During the transmitting, the transmission indicator light on X6200 will turn red, as will the indicator light on hand microphone.
3. Release the PTT button to return to the receiving state.

Transmit in CW mode

Insert the KEY interface on the right side of the X6200 with a manual key or an external keyer. (see Page 10 for the definition of wiring)

Operation method:

1. Insert the key plug into the KEY interface;
2. Press [CW] button on the top of radio to switch mode to CW (or CWR);
3. Turn on QSK function in menu and set appropriate QSK time;
4. Press telegram key to enable CW communication.
 - If the "CW TRAINER" trainer is enabled in the KEY menu, there will be only CW sidetone of transceiver after the key is pressed, but signals will not be transmitted externally.

Automatic antenna tuner

There is an efficient ATU integrated inside the X6200 radio to help you quickly erect and debug antenna.

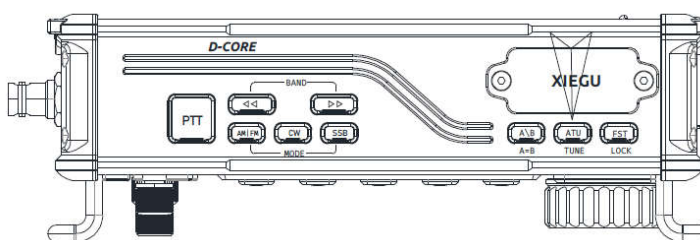

1. Press [ATU] key in a short time to connect with built-in antenna tuner. There will be an antenna icon at the top of screen.
2. In the case that the antenna tuner is accessed, long press and hold the [ATU] key for 1s to start ATU automatic tuning functions. It will automatically return to receiving state after the tuning.

Attention!

1. Short press [ATU] key, and there will be an ATU icon at the top of screen, indicating that antenna tuning functions are enabled. The functions are only enabled but not working.
2. After the antenna tuner is tuned, the antenna tuner must remain to be open before the antenna tuner in the machine is used.
3. If "ATU" icon is displayed at the top of the screen and flashes once transmitting is enabled after the tuning, it indicates that standing-wave of current antenna is still large and tuning is required to be carried out again.
4. Antenna tuning shall be turned off once natural resonance of antenna reaches current frequency band.
5. **When a whip or monopole antenna is used and the internal antenna tuning is started for tuning, strong radio frequency interference may be caused to the unit or other electronic equipment.**

Use the radio PPT key for transmission

The X6200 body integrates PTT button and build-in microphone, which make it convenient when using the radio outdoors.

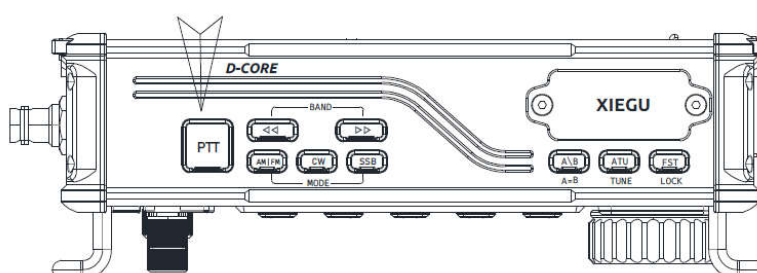

Operation method:

1. Press the PTT button on the top of the device and speak to the built-in microphone hole at the left of large knob to transmit voice.
2. Release the PTT button after transmitting to return to receiving status.

Attention!

- Do not place the antenna very close to or near exposed parts of the body, especially the face or eyes, when transmitting in hands.

Lock button

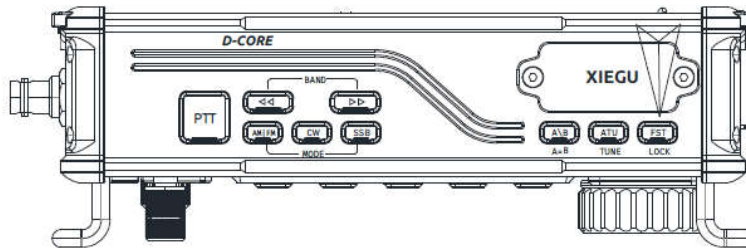

Operating method:

1. Long press the [FST] button at the top to lock the operation of the key and main knob, and the symbol of "Lock" will be displayed at the upper right of the screen.

Multi-functional Menu Operation

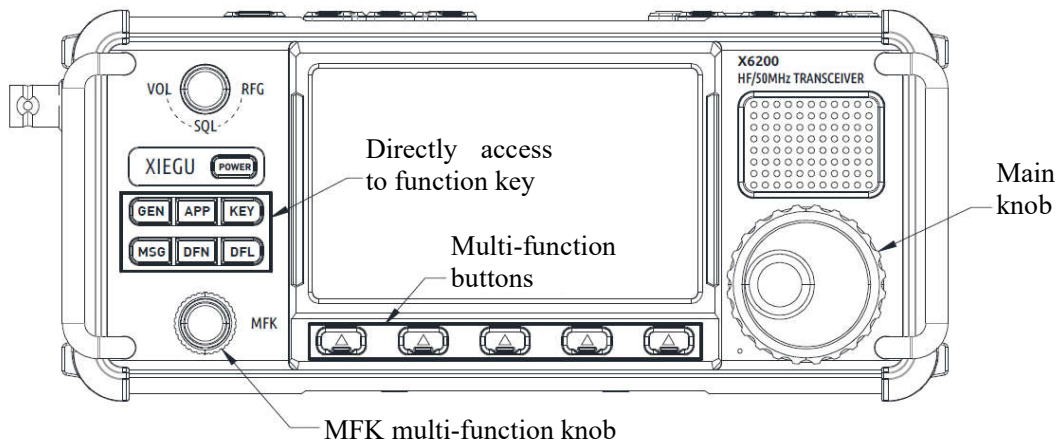

Basic operating methods:

1. Function buttons in the left area of the panel can directly access the common function operation menu.
2. After selecting any of the function keys, a corresponding menu will appear at the bottom of the screen. Short press the corresponding button at the bottom of the screen to operate the function.
3. After selecting a function, rotate the large knob or MFK multi-function knob to adjust the corresponding parameter value. The adjustment parameters are displayed in the numeric part of the Function menu tab.

- The X6200 can display both English and Chinese interfaces. The following operation steps will be explained with an English interface.

GEN function operation

After short pressing the [GEN] key, the Default menu will appear at the bottom of the screen, as shown in the following figure:

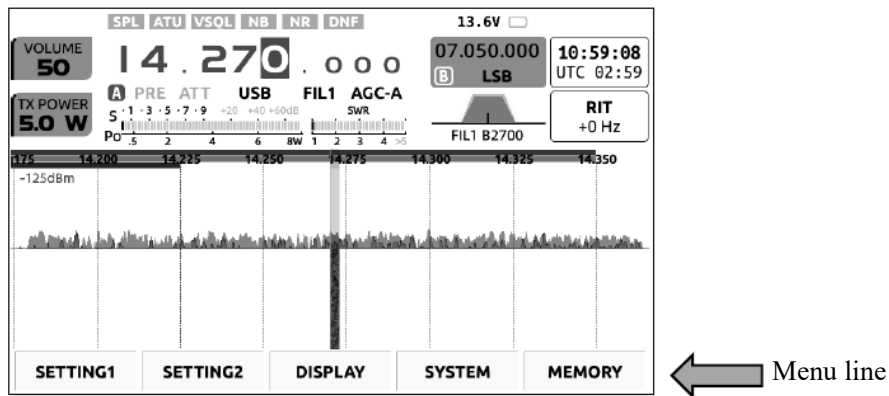

Short press the key corresponding to [SETTING1] to enter the "General Setting 1" submenu, as shown in the following figure:

Operation method:

1. Rotate the MFK outer knob and scroll to select the item to be adjusted. As shown in the right figure, select the "AGC LEVEL".
2. Rotate the MFK inner knob to adjust the value of the current item.

Operational icon

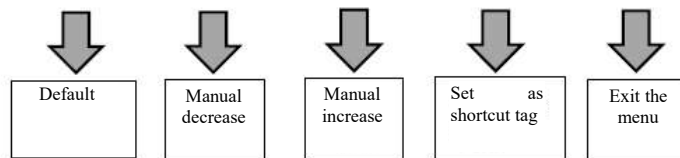
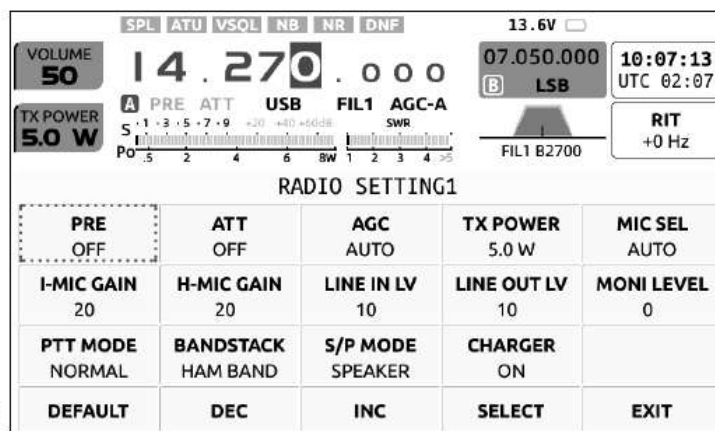

Menu functions are defined as follows:

PRE	ATT	AGC	TX POWER	MIC SEL
Pre-amplification	Pre-attenuation	Automatic gain	Transmission power	Microphone selection (Microphone/hand microphone)
I-MIC GAIN	H-MIN GAIN	LINE IN LV	LINE OUT LV	MONI LEVEL
Microphone gain	Hand microphone gain	Line input gain	Line output gain	Monitoring level
PTT MODE	BANDSTACK	S/P MODE	CHARGER	-----
PTT mode	Band register	Speaker/headphone mode	Charging switch	-----

Short press the key corresponding to [SETTING 2] to enter the "General Setting 2" submenu, as shown in the following figure:

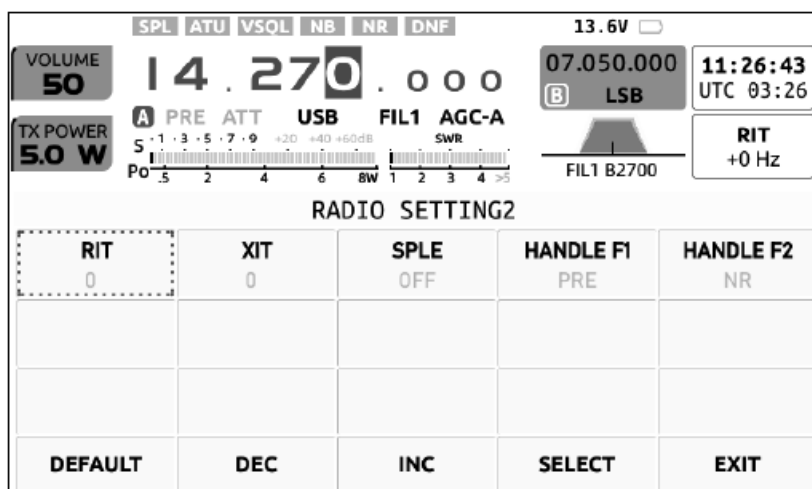

Menu functions are defined as follows:

RIT	XIT	SPLE	HANDLE F1	HANDLE F2
Receiving offset	Emission offset	Split frequency transmission and reception	Hand microphone F1 key setting	Hand microphone F2 key setting

DISPLAY menu

Short press the key corresponding to [DISPLAY] to enter the "Display Setting" submenu, as shown in the following figure:

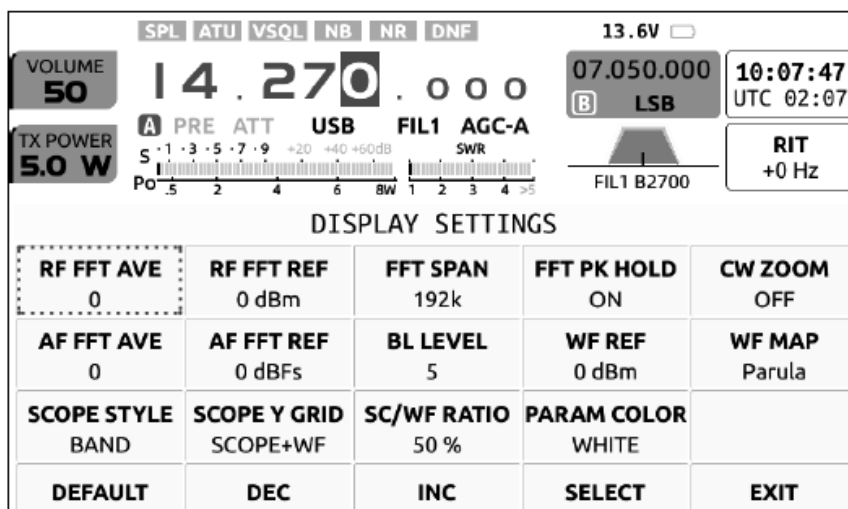

Menu functions are defined as follows:

RF FFT AVE	RF FFT REF	FFT SPAN	FFT PK HOLD	CW ZOOM
RF spectrum average	RF spectrum reference	Spectrum bandwidth	Spectrum peak maintenance	CW scaling
AF FFT AVE	AF FFT REF	BL LEVEL	WF REF	WF MAP
Audio spectrum average	Audio spectrum reference	Backlight	Waterfall reference	Waterfall coloring
SCOPE STYLE	SCOPE GRID	SC/WF RATIO	PARAM COLOR	---
Spectrum style	Spectrum Y scale style	Spectrum/waterfall display ratio	Parameter character color	

SYSTEM menu

Short press the key corresponding to [SYSTEM] to enter the "System Setting" submenu, as shown in the following figure:

SYSTEM SETTING				
TIME SETTING	SYSTEM INFO	FIRMWARE UPGRADE	WLAN	BLUETOOTH
WFSERVER	Language Settings			
FACTORY RESET				
				EXIT

Menu functions are defined as follows:

TIME SETTING	SYSTEM INFO	FIRMWARE UPGRADE	WLAN	BLUETOOTH
Time setting	System information	Firmware upgrade	Wireless network	Bluetooth
WFSERVER	Language Settings			
Remote control				
FACTORY RESTE	---	---	---	---
Factory default reset	---	---	---	---

MEMORY menu

Short press the key corresponding to [MEMORY] to enter the "Memory setting" submenu, as shown in the following figure:

Menu line

TAG	MARK	ERASE MEMO	SAVE VFO	EXIT
Edit tag name	Set mark	Clear the current channels	Store the current VFO into channels	Exit the menu

Example of Memory Channel Operation:

The current frequency is VFOA: 14.270000/USB, VF0B: 7.050000/LSB

1. Short press [SAVE VFO] to save the current frequency, mode, etc. into a blank channel. As shown in the figure below:

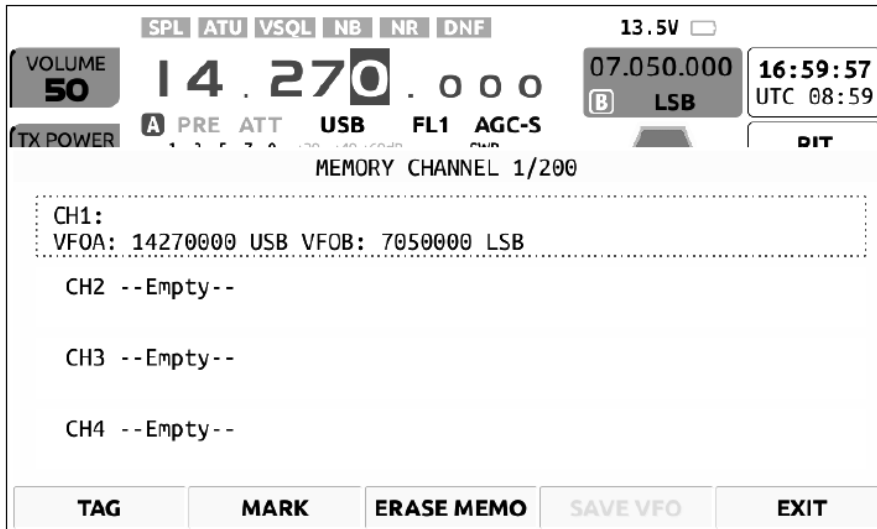

2. Short press [TAG] to name the current channel.
3. Short press [MARK] to mark the current channel, and the symbol of a small house will be displayed on the channel tag.

Example of Clearing Channel Operation:

1. Turn the main knob to select the channel tag you want to clear.
2. Short press [ERASE MEMO] to clear the channel information of the memory.

APP function operation

Short press the [APP] button on the upper left side of the panel to enter the "Application" submenu, as shown in the following figure:

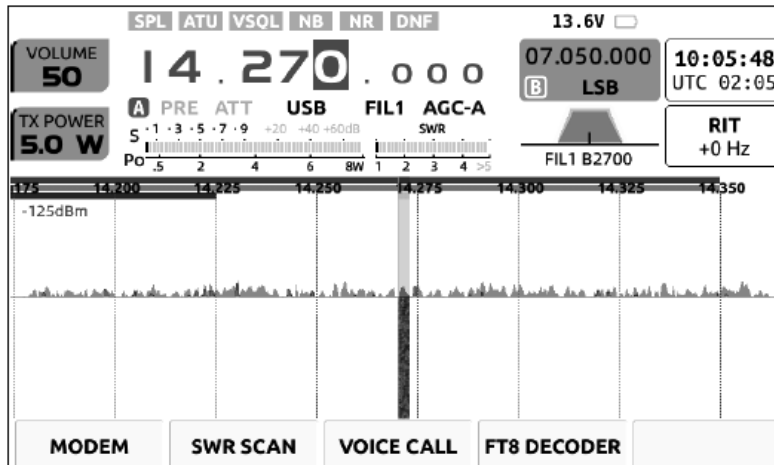

Menu functions are defined as follows:

MODEM	SWR SCAN	VOICE CALL	FT8 DECODER	---
Modem	Standing-wave scanning	Voice call	FT8 decoder	---

MODEM menu

Short press the corresponding key of [MODEM] to enter the sub-menu of the "Modem", as shown in the figure below:

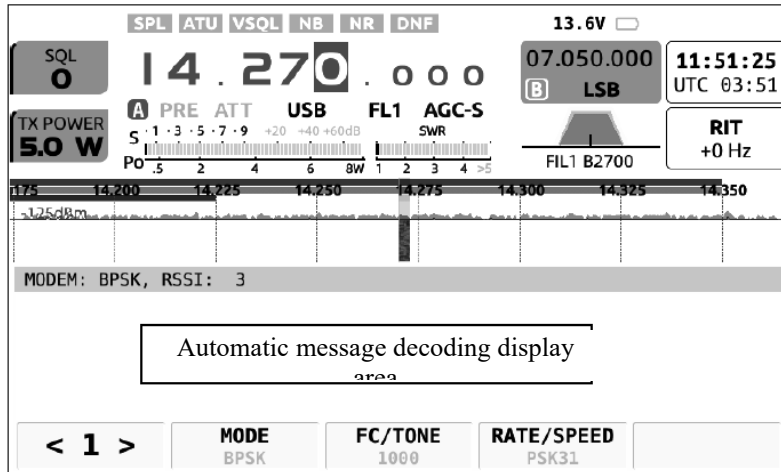

The submenu <1> is defined as follows:

<1>	MODE	FC/TONE	RATE/SPEED	---
	Select RTTY/CW/BPSK mode	Carrier/side tone frequency	Baud rate/code rate	

Short press the key corresponding to <1> below the screen again to enter the submenu <2>, defined as follows:

<2>	AFC	SQL	CLEAR	EXIT
	Carrier tracking	Modem muting	Clear text	Exit

Automatic sending of preset information under MODEM

In the MODEM interface, short press the [MSG] key on the left side of the panel to enter the automatic message sending interface, as shown in the figure below:

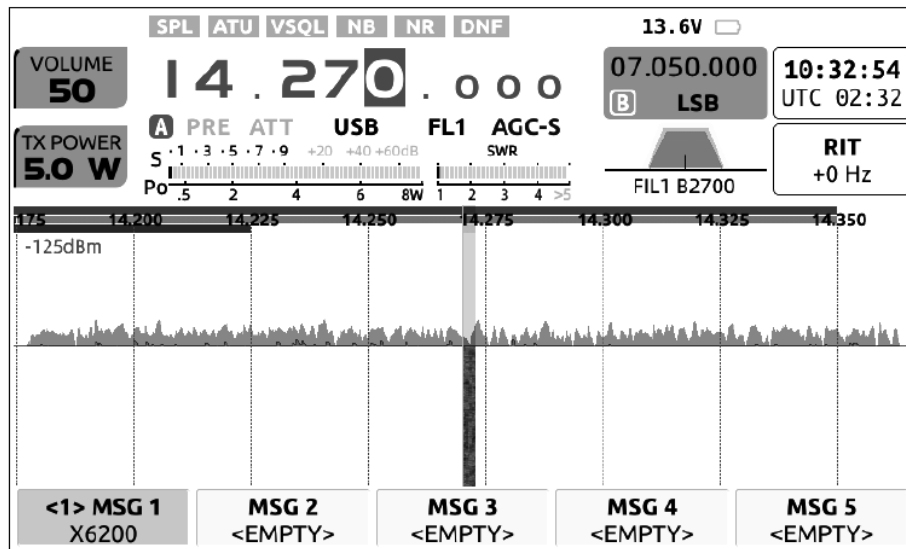

Operation method:

1. When a tag has pre-stored information, there is information preview under the tag. The above figure shows that: MSG1 tag already has pre-stored information; the tag has information preview, which is convenient for users to quickly find the required call tag.

2. Press the corresponding tag, X6200 will start sending the preset text information in the tag in the mode (CW, PSK, PTTY) selected by MODEM until the sending of information is completed.

SWR SCAN standing wave scanner operation

The X6200 has the antenna standing-wave scanner, which can scan the standing-wave parameters of the current antenna to help users adjust the antenna.

Operation method: Short press the corresponding key of [SWR SCAN] to enter the sub-menu of the "Standing-wave Scanner", as shown in the figure below:

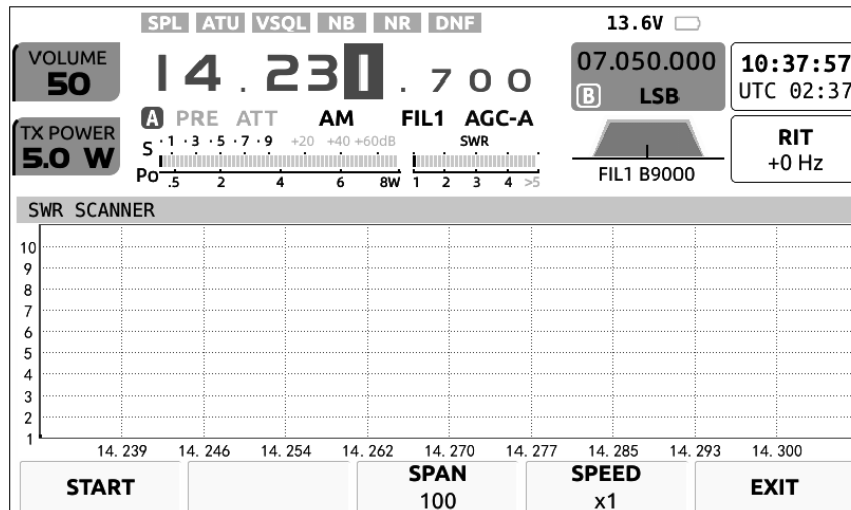

Menu functions are defined as follows:

START	---	SPAN	SPEED	QUIT
Start scanning	---	Scan bandwidth	Scan speed	Exit

START: Short press this button to start scanning. Short press again to stop scanning.

SPAN: short press this key to change the scanning bandwidth.

SPEED: short press this key to change the scanning speed.

QUIT: exit the standing-wave scanner interface

■ The scanning results from the standing-wave scanner may have some errors, for reference only of temporary use. For accurate measurement of antenna standing waves and other data, please use the professional antenna analysis equipment for measurement.

FT8 DECODE

The X6200 can directly decode and display information for FT8 communication.

Operation sequence:

[APP] - [FT8 DECODER], enter the FT8 decoding interface. The demodulated information will be displayed overlaid in the spectrum area, as shown in the following figure:

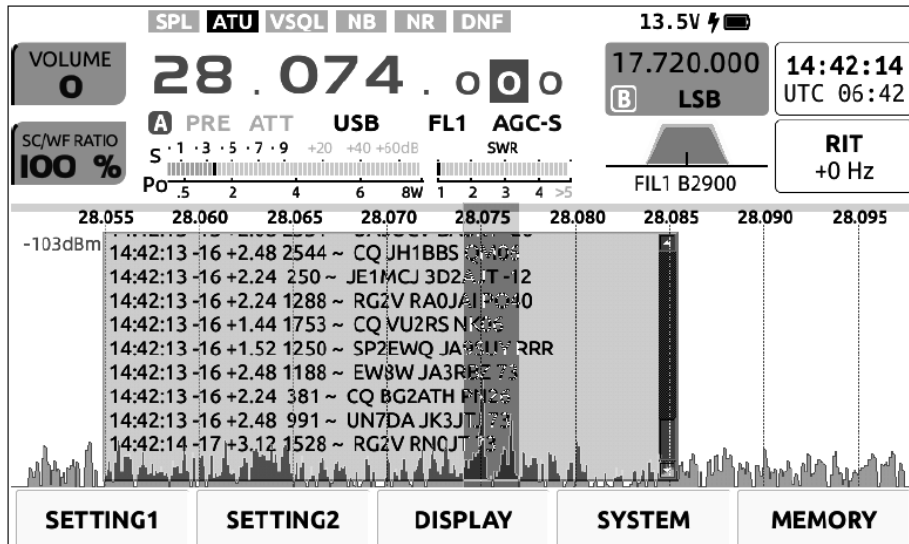

Recording automatic call

X6200 has a built-in recording caller, which can record and store the call voice in the machine in advance, and the stored voice can be used for call transmission.

Operation sequence:

[APP] - [VOICE CALL], enter the recording call interface, as shown in the figure below:

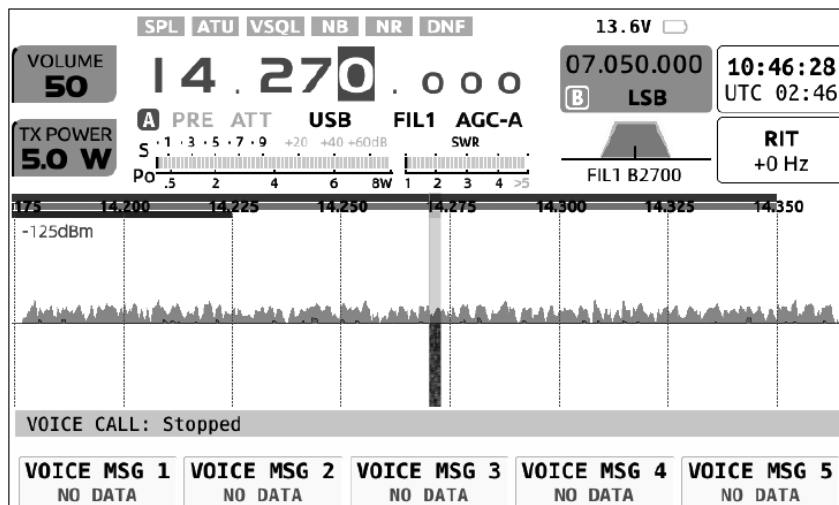

Operation method:

1. When a tag has pre-stored information, there is a prompt under the tag to facilitate users to quickly find the required call tag.
2. Press the corresponding tag, X6200 will start sending the preset recording information in the tag until the sending of information is completed.

■ For the recording method of voice messages, see the relevant operation chapter of "MSG" key.

KEY function operation

Short press [KEY] to enter the menu of KEY items, as shown in the figure below:

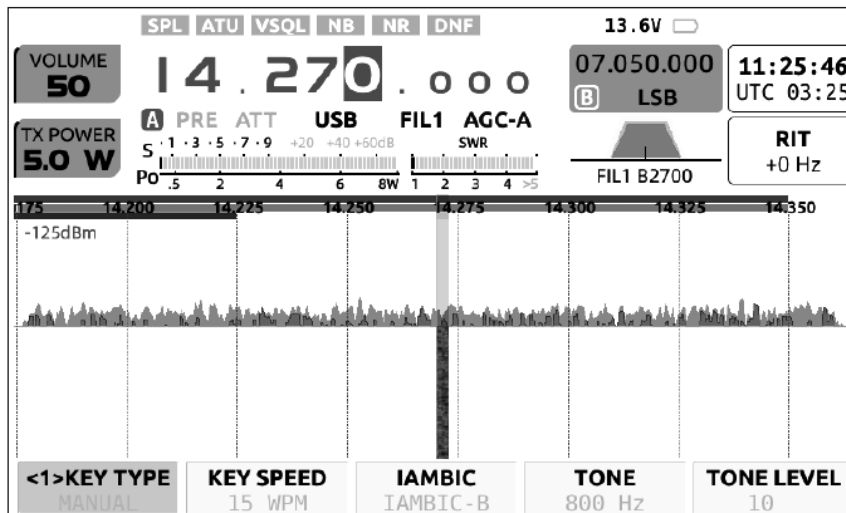

The function of menu <1> is defined as follows:

KEY TYPE	KEY SPEED	IAMBIC	TONE	TONE LEVEL
Key mode	Auto key speed	Alternate mode	Beat frequency	Beat frequency volume

Press the [KEY] key again to enter the menu on the second page of KEY items:

The function of menu <2> is defined as follows:

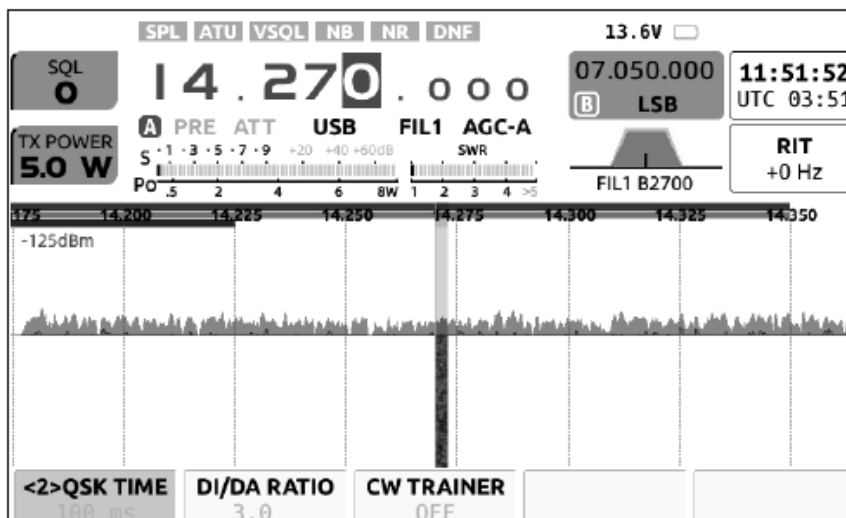

QSK TIME	DI/DA RATIO	CW TRAINER	---	---
CW transmit-receive switching time	Dot-and-dash ratio	CW trainer	---	---

MSG function operation

Short press [MSG] to enter the text preset menu on the first page of MSG, as shown below:

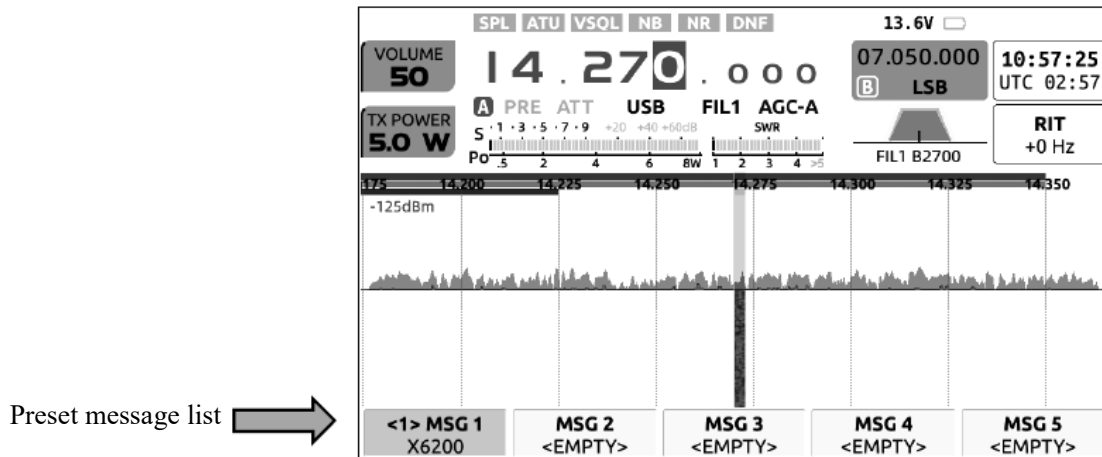

X6200 can pre-store 5 preset messages. These messages can be used for automatic transmission of CW, RTTY and BPSK. Click any MGS label to enter the editing interface, as shown below:

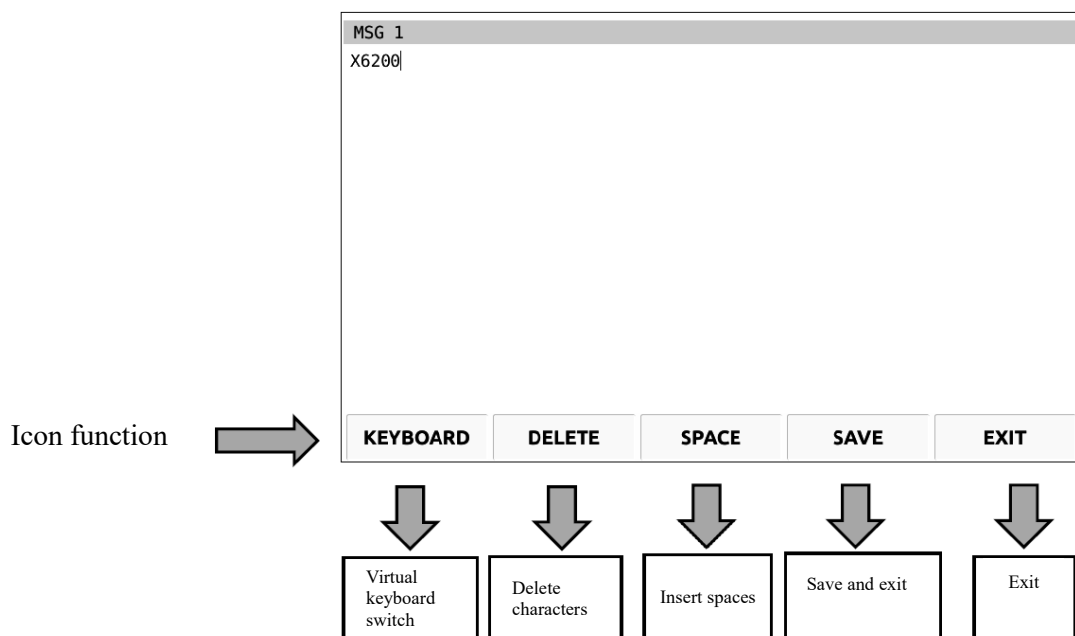

Open the virtual keyboard as shown in the figure on the right:

1. Rotate the MFK inner or outer knob to select the character to enter.
2. Press the MFK knob to determine to enter the current character.
3. Press the [KEYBOARD] button again to switch to the digit symbol and IPv4 digit input interface.
4. Press the button corresponding to [Close] to exit the virtual keyboard.

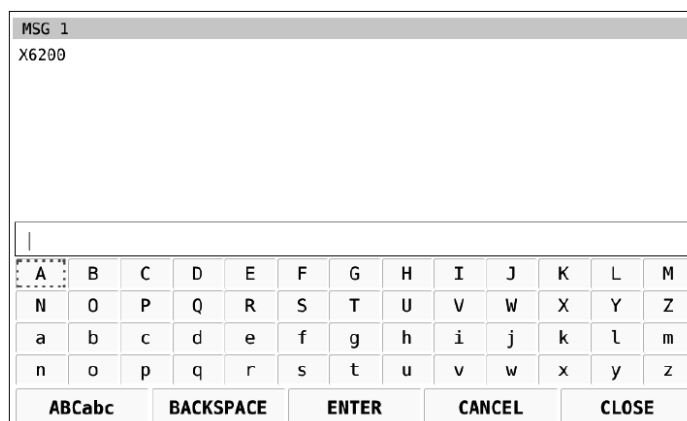

Voice recording

Press [MSG] again to enter the voice recording menu page on the second page of MSG options:

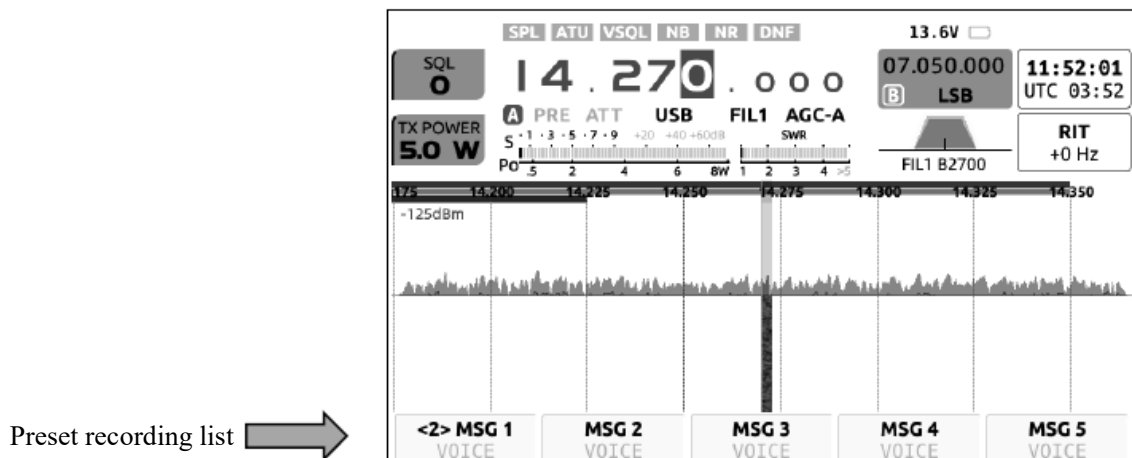

X6200 can pre-store 5 voice messages. These messages can be used for automatic transmission of voice mode. Click any MSG label to enter the editing interface, as shown below:

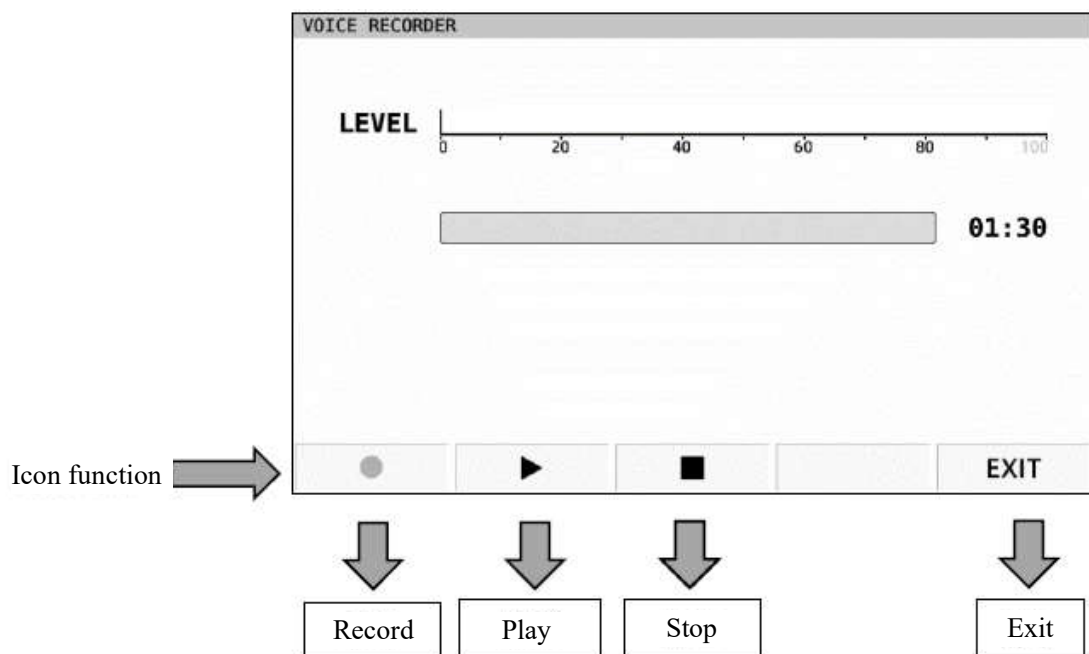

Recording operation method:

1. Pick up the hand microphone and keep it about 5~10cm away from the lips.
2. Press the "Record" key and start speaking at a normal volume until the speech is finished.
3. Press the "Stop" key to stop recording.
4. Press the "Play" key to listen to the voice just recorded.
5. Press the "EXIT" key to exit the current page.

Attention!

- The maximum duration of each recording is 1 minute and 30 seconds.
- When recording, please turn off the monitoring function to avoid the echo. During daily use, the monitoring volume shall not be set too large, otherwise it may cause a sound echo.

DFN function operation

1. Short press [DFN] to enter the menu on the first page of DFN options, as shown below:

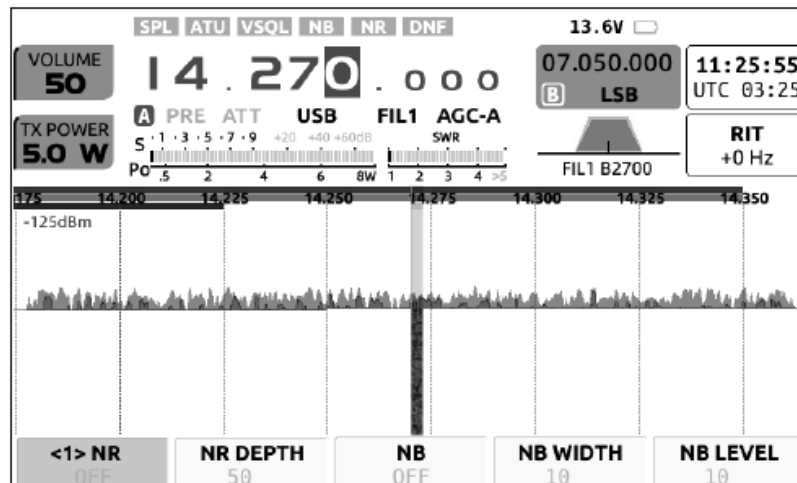

The function of menu <1> is defined as follows:

NR	NR DEPTH	NB	NB WIDTH	NB LEVEL
Noise reduction switch	Noise reduction depth	Pulse suppression	Pulse noise width	Pulse noise level

2. Press [DFN] again to enter the menu on the second page of DFN options:

The function of menu <2> is defined as follows:

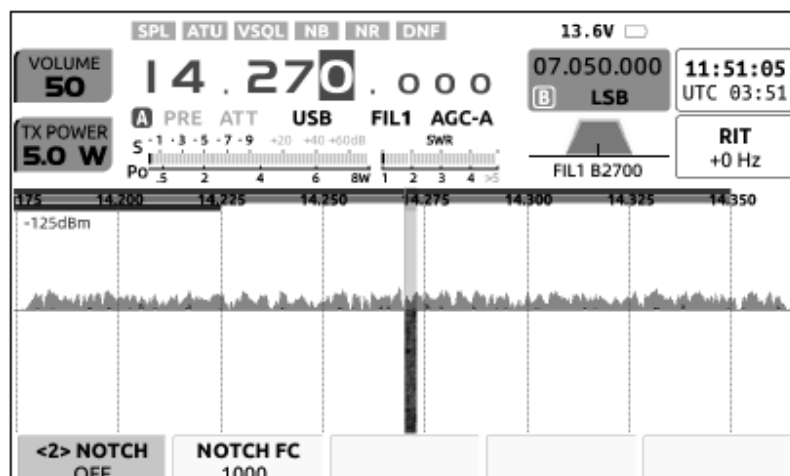

NOTCH	NOTCH FC	---	---	---
Notch filter	Notch frequency	---	---	---

DFL function operation

Short press [DFL] to enter the DFL option menu, as shown below:

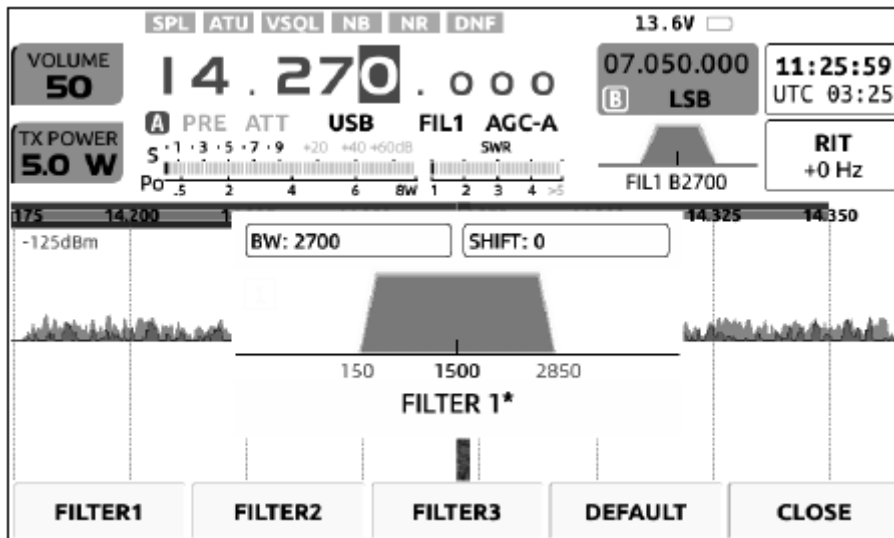

Operation method:

1. Select any filter from FILTER1~3 to enter.
2. Short press the MFK knob to switch and select different filter edges (red or blue trapezoidal box). The blue trapezoidal box is the high-cut filter (H-CUT), and the red trapezoidal box is the low-cut filter (L-CUT).
3. Rotate the MFK outer knob to adjust the parameters of the filter according to the actual use. After adjustment, the current filter parameters will be automatically stored in the corresponding filter label.
4. Short press [DEFAULT] to restore the filter parameters selected currently to the default parameters.
5. Short press [CLOSE] to exit the current interface.
6. The parameters of each filter bank differ with modes, and will be automatically switched in line with the current mode.
7. As shown in the figure above, the start frequency and cut-off frequency of the filter can be adjusted respectively to set the filter. The overlapping region of the two schematic trapezoidal filter graphs is the actual action range of the filter. The details are as follows:

Filter composition diagram:

As shown in the figure on the right, the filter is acted by L-CUT and H-CUT together to form an effective filter bandwidth.

L-CUT controls the low boundary frequency and can effectively cut off the low frequency component;

H-CUT controls the high boundary frequency and can effectively cut off the high frequency component;

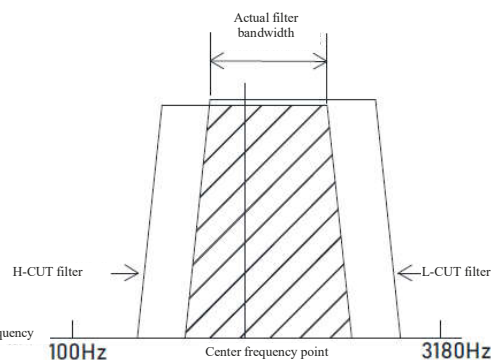

In daily use, it can be adjusted according to own habits to achieve the best listening effect.

Attention!

If the actual bandwidth of the filter is smaller than that of the useful signal, the useful signal will be completely cut off, resulting in no signal to be heard.

Set time/view system information/update firmware/restore factory settings

SYSTEM SETTING				
TIME SETTING	SYSTEM INFO	FIRMWARE UPGRADE	WLAN	BLUETOOTH
WFSERVER	Language Settings			
FACTORY RESET				
				EXIT

Key sequence:

[GEN] - enter the system setting interface via the multi-function key [SYSTEM] at the bottom of the screen and select "TIMESETTING".

Time setting method:

1. Enter the corresponding option menu, rotate the MFK knob to select items of year, month, day, hour, minute, and time zone settings; Press the MFK knob to select the current option, rotate the large knob to adjust the number, and finally press MFK again to exit the current option.
2. After adjusting, rotate the MFK to select the "OK" button and press the MFK knob to confirm.

Attention!

- If it is set to local time, do not set the time zone.

View system information:

Rotate the MFK outer knob, select the [SYSTEM INFO] menu item, press the MFK knob to enter the project, and view the firmware version information.

Updating firmware:

When updating firmware, rotate the MFK knob, select the [FIRMWARE UPGRADE] menu item, press the MFK knob to enter, select the firmware that needs to be updated, press the button corresponding to [UPGRADE] to start updating. Remote control:

Rotate the MFK outer knob, select the [WFSEVER] menu item, and press the MFK knob to enter the corresponding remote control settings.

Please refer to Appendix 3 for specific settings.

Restore factory settings:

Attention! Restoring factory settings will clear all your personalized settings.

1. Rotate the MFK knob, select [FACTORY RESET], press the MFK knob, and select.
2. Read the on-screen prompts and press the "OK" button twice to confirm reset.
3. After the reset is completed, the X6200 will automatically shut down. Manually power on again to complete the reset.

Set wireless network parameters

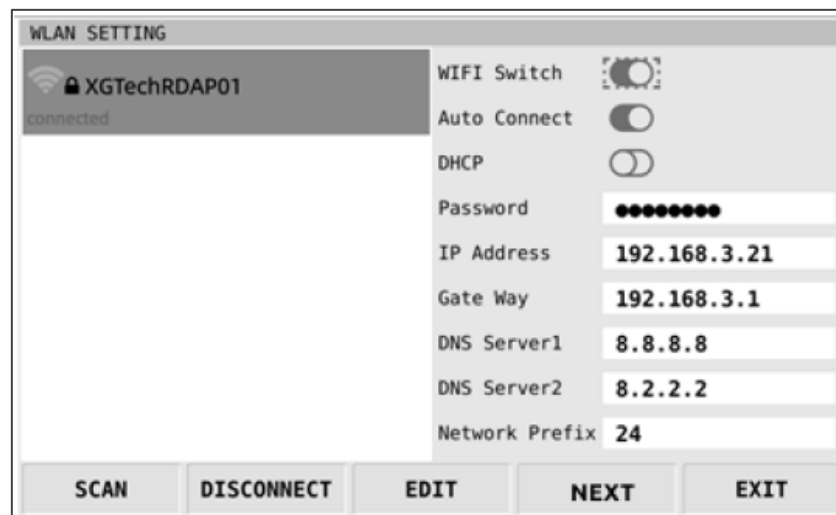

Key sequence:

[GEN]---Via the multi-function key [SYSTEM] at the bottom of the screen, enter the system setting interface, and select the option WIFI.

Key description:

SCAN: Scan for nearby access points (Access Point)

CONNECT/DISCONNECT: Connect/ disconnect the access point selected in the list on the left

EDIT: Edit the element selected by the orange border on the right

NEXT: Select the next item with the orange border on the right side

EXIT: Exit

Operating instructions:

1. When entering the interface for the first time, press the [EDIT] button to turn on the WIFI switch.
2. Turn the MFK knob and select the wireless network to be connected in the left

box.

3. Enter the necessary information in the information box on the right. The following three items must be entered correctly (key):

- Password: Password
- IP Address: Manually assign an IP address, with the same network segment as the wireless router.
- Gate Way: Gateway address. The gateway address shall be the same as the network segment of the wireless router.

4. The DNS and Net Work Prefix options can be left blank by default.

5. After entering the correct configuration information, press the [CONNECT] button to connect to the network. After successfully connecting to the network, a green "connected" message will be displayed on the label of the currently connected wireless router on the left.

6. Press the [DISCONNECT] button to disconnect the current connection.

7. In the case of access to WIFI and Internet, the time server will automatically synchronize after a certain time. You can also manually synchronize it once.

Note!

- Do not turn the MFK knob when entering the information, otherwise the information that has not yet been completely input will be lost.
- The configuration information will be automatically saved after connection. Configuration information for unsuccessful connections will not be saved.
- Some wireless routers that support advanced protocols and new frequency bands may be unable to connect and automatically allocate IP addresses. It is recommended that users manually assign the IP address of the device.

Set Bluetooth function

The Bluetooth function can be used to connect peripheral devices such as Bluetooth keyboards, Bluetooth mice, or Bluetooth serial ports, for direct input of information, operation of clicks, control, etc.



Operation sequence:

[GEN]---Via the multi-function key [SYSTEM] at the bottom of the screen, enter the system setting interface, and select the Bluetooth option.

Operating instructions:

OFF/ON: Turn on/off the Bluetooth adapter

SCAN: Scan surrounding Bluetooth devices

CONNECT/DISCONNECT: Connect/disconnect the Bluetooth device selected in the list on the left

EXIT: Exit

Note!

1. When the Bluetooth adapter is on, it will continuously scan for surrounding Bluetooth devices.
2. When connecting the device, it will automatically pair without manually entering a PIN code.
3. If the device is turned off while connected via Bluetooth, Bluetooth will attempt to automatically connect again after the next power on.

Forced shutdown

In case of abnormal startup/shutdown owing to startup failure, system crash or other factors, forced shutdown of the system can be performed as follows:

- Long press the switch button for more than 12s until the indicator light, screen, or sound are turned off.

If the above forced shutdown method is still ineffective, you can unplug the external power supply and remove the battery board to directly power off the device.

Appendix 1

Connection between X6200 and XPA125B (L4001 Cable)

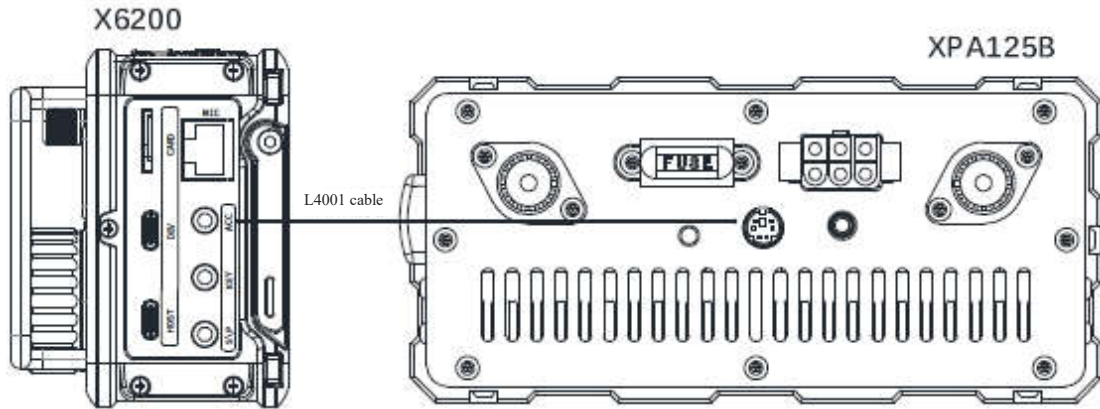

After the X6200 connects with XPA125B power amplifier and antenna tuner AIO through the L4001 cables, the output power can be expanded to 100W.

After connection, the X6200 can automatically control the wave band switching of XPA125B. Moreover, the ALC control will be built between two machines. When the X6200 output power exceeds the power limit of the XPA125B, the AACL control will automatically decrease the output power of the radio so that the output power of the XPA125B will be constant.

We suggest to set the output power of the X6200 to be 2-3W.

- XPA125B power amplifier and L4001 cable need to be separately ordered.

Appendix 2

Connection between X6200 and Computer for Data Communication & Control

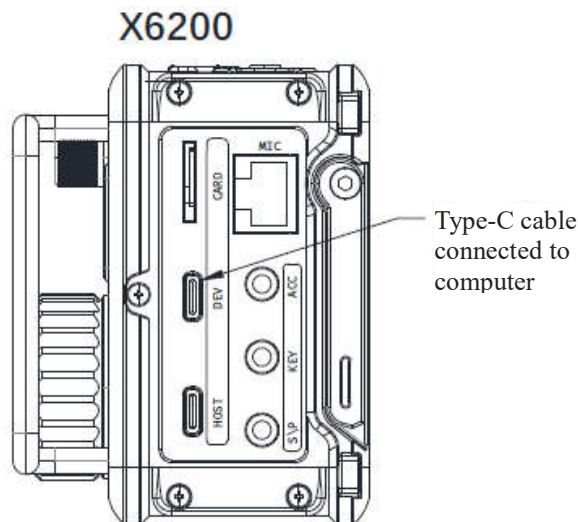

1. As shown in the above figure, connect the Type-C cable to the DEV port on the right side of the X6200.
2. The CH342 port driver shall be installed, or the driver tool may be used to install it online.
3. Select the model "XIEGU X6200" on the data communication software (or control software) to complete the connection.

4. Please choose the sound card virtualized by the host for sound input/output. It shall be noted that different sound devices are required for input and output.

Attention!

■ If you choose other models compatible with CIV instructions, some instructions may not be responded to.

Connect to N1MM and automatically send CW

The connection method is the same as above, and the port is also connected to the DEV port on the right side of X6200. Once the settings for the N1MM end are configured, the X6200 can be controlled by a PC to send CW telegrams.

External mouse and keyboard

Once connecting external input devices such as the mouse and keyboard to the HOST interface on the right side of the X6200, and you can use the external mouse and keyboard to click and input operations on the host.

◆ Note: The two USB ports of X6200 cannot be connected to external USB-Hub devices.

Appendix 3

Setting Method for Remote Control of WFSERVER Radio Station End

Operation method:

1. Rotate the MFK knob, select the [WFSERVER] menu item, press the MFK knob to enter the remote control setting interface, as shown in the following figure, and set according to the information in the figure:

WFSERVER SETTING (server stopped)	
RIG NAME	X6200
USER NAME	user
PASSWORD	123
CTRL PORT	50001
CIV PORT	50002
AUDIO PORT	50003

With wfview server from the wfview team:
Elliott (W6EL), Phil (M0VSE), Roeland (PA3MET) and
Jim (PA8E).
Source code available at wfview.org

START DEFAULT CLEAR SAVE EXIT

2. After the configuration is completed, press the button corresponding to [START], wait a few seconds, and then complete the setting.

3. After the setting is completed, return to the main screen. A WF blue icon will be displayed in the upper right corner, indicating that the remote control function has been turned on, as shown in the following figure:

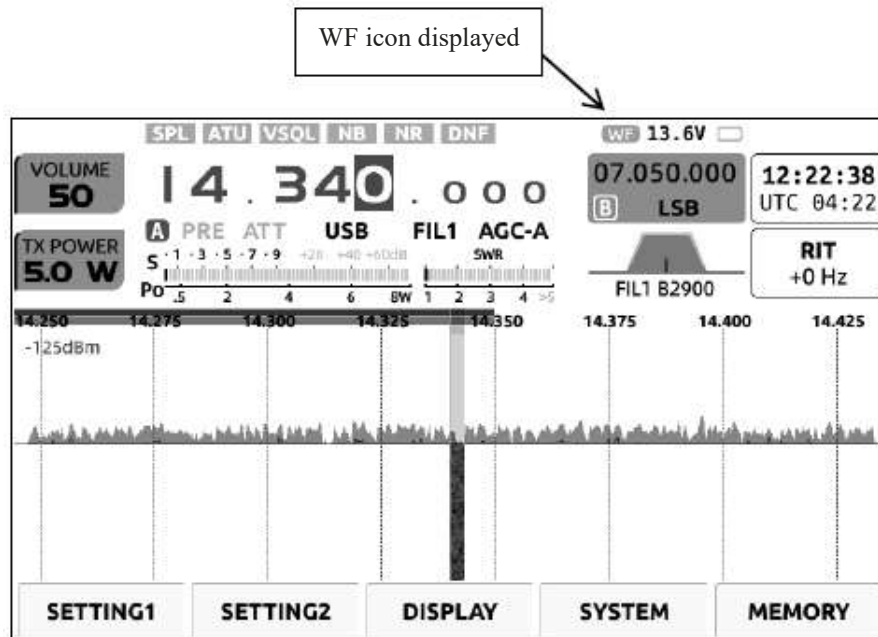

Parameter Specifications

Frequency range:	Receive:	0.5MHz~30MHz 88.0~108.0MHz	50.00~54.00MHz 108.0~136.0MHz
	Transmit:	1.8~2.0MHz 7.0~7.2MHz 14.0~14.35MHz 21.0~21.45MHz 28.0~29.7MHz	3.5~3.9MHz 10.1~10.15MHz 18.068~18.168MHz 24.89~24.99MHz 50.00~54.00MHz
Working mode:		CW, AM, SSB, FM	
Minimum step:		1Hz	
Antenna impedance:		50Ω	
Operating temperature range:		0°C~+50°C	
Frequency stability:		±1ppm in the 10min after startup @25°C: 1ppm/h	
Power voltage:		9.0~15.0VDC, negative electrode grounding	
Current consumed:		Receive: 650mA@ Max Transmit: 3A@ Max	
Body size:		About 200*89*51mm (L*W*H) (not including protrusions)	
Weight:		About 930kg (only host)	

Transmitter parameters

RF output power:	8W (SSB/CW/FM)±1dB @13.8VDC 4W (AM carrier) @13.8VDC 5W(SSB/CW/FM)±1dB (battery) 2.5W (AM carrier) @battery
Spurious suppression:	≥50dB
Carrier suppression:	≥50dB
Microphone impedance:	200~10k (600Ω in general)

Receiver parameters

Circuit type:	RF direct sampling
Sideband suppression:	≥50dB

MDS: -138dBm

Sensitivity:

Band \ Mode	SSB/CW	FM	AM	WFM/AM
0.5~1.799999MHz	/	/	10uV	/
1.8~1.999999MHz	0.20uV	/	10uV	/
2.0~27.999999MHz	0.20uV	/	2uV	/
28.0~30.000000MHz	0.20uV	0.20uV	2uV	/
50.0~54.000000MHz	0.20uV	0.20uV	2uV	/
88~108MHz(WFM)	/	/	/	Greater than 10uV
108-136MHZ (AM)	/	/	/	Greater than 10uV

(PRE=on, ATT=off, NB=off, NR=off, AGC=on)

Audio output: 0.5W (4Ω, ≤10% THD)

Audio output impedance: 4~16Ω

Antenna tuner unit

Antenna tuner tuning impedance range: 20Ω~175Ω

Initial tuning time: ≤10s

Memory load tuning: ≤0.1s

- All specifications are typical and apply to amateur bands only. Due to technical improvements, the above specifications are subject to change without notice.
- The operating frequency range of transceivers sold in different countries or regions will be set according to local regulations. Ask local dealer for details.

Packing List

Item name	Quantities
X6200 host	1 set
Type-C data line	1 pc.
Multi-function hand microphone	1 pc.
Charging adapter	1 pc.
Power cord	1 pc.
Warranty card	1 copy
User Manual	1 copy
Certificate of conformity	1 copy (printed on the packaging box label)

XIEGU

Wireless Technology, Unlimited Creativity



©Weisheng Communication

2018-2024

Edition Mar 2024

XDC-C01

www.cqxiegu.com

The information in this manual may be updated with device firmware upgrades without prior notice.