

YAESU

The radio

REFERENCE MICROPHONE *M-1*



Contents

General Description	1	SCOPE key	10
Safety Precautions	2	MONITOR Volume knob	10
Controls & Connections	4	POWER Switch	11
PTT key	4	DC IN 5V Jack.....	11
LOCK key.....	4	PHONES Jack.....	11
MIC.....	5	RX AUDIO IN Jack.....	12
Angle adjustment knobs.....	5	MIC Jack	12
Height adjustment ring	5	Cannon (XLR) Microphone Connector...12	
Display	6	PTT key operation selector switch	13
Graphic equalizer adjustment knobs.....	6	RX ATT switch.....	13
DUAL key	7	Convenience Functions	14
C/D key	7	Setting the Display Contrast.....	14
Equalizer memory keys.....	8	Reset.....	15
Recording/Playback key.....	8	Frequency characteristics	
LC (Low Cut) key	9	of the microphone	16
THR (THRU) key.....	9	Specifications	16
MIC GAIN adjustment knobs.....	10		

Supplied Accessories

Treble boost cowling.....	1
AC Adapter (SAD-17 or SAD-22)	1
Power Code.....	1
Microphone Cable	1
Dedicated Alignment Tool	2
Instruction Manual (this manual)	1
Warranty Card	1

Dual microphone configuration features

The M-1 features two built-in microphone elements, one dynamic and one condenser. The unique output signals may be individually crafted and then blended to produce a single rich voice signal. The condenser microphone responds to a broad frequency range including the distinctive crisp highs, while the dynamic microphone adds depth and warmth, providing the emotional subtext desirable for a genial “ragchew”. The M-1 lets you fine-tune and balance the two microphone sources to create a sound that will compliment your own voice.

Nine-band graphic equalizer for each microphone element

The nine-band graphic equalizer is applied to each microphone element independently, giving total flexibility to accentuate and enhance the frequency characteristics of both the dynamic and condenser microphone output signals. The individual frequency profiles are easily adjusted on the graphic equalizer, using the rotary encoders below the display. The built-in equalizer memories can store two different groups of settings for each microphone. Stored settings (Memories 1 and 2) can be accessed instantly.

A through (flat) preset is also provided. By blending the two microphone outputs together, you can create your own unique tonal quality. The M-1 adds a new level to the audio creative process.

Treble boost cowling produces a unique tonal texture

The simple clip-on cowling enhances the high-frequency response of both microphone elements, and can minimize the aural interference from either side. The cowling serves to concentrate the voice input with a peak at around 1 - 1.5 kHz, producing a unique tonal texture.

Air cylinder magnetic contactless PTT key

The PTT key with contactless triple air cylinder magnetic construction delivers smooth fingertip-sensitive operation over an extended stroke distance.



The key has been designed with optimal balance between key weight and stroke to provide the perfect tactile response. Meanwhile, the contactless switch provides years of fault-free operation with minimal mechanical degradation.

- The built-in record and playback feature provides monitoring your voice in the headphones to allow meticulous evaluation and adjustment.
- Features a built-in, one-click DSP filter that is independent of the graphic equalizer.
- Connect headphones directly to the M-1 and check the microphone audio in real time, listen to test recordings, or monitor the transceiver signal.
- The M-1 microphone outputs include a balanced XLR jack as used on professional sound equipment for superior audio quality and noise shielding.





Safety Precautions

Note beforehand that the company shall not be liable for any damages suffered by the customer or third parties in using this product, or for any failures and faults that occur during the use or misuse of this product, unless otherwise provided for under the law.

Type and meaning of the symbols

	DANGER	This symbol indicates the possibility of death or serious injury being inflicted on the user and the surrounding people when these instructions are ignored and the product is mishandled.
	WARNING	This symbol indicates the possibility of death or serious injury being inflicted on the user and the surrounding people when these instructions are ignored and the product is mishandled.
	CAUTION	This symbol indicates the possibility of physical impediments occurring or impediments being inflicted on the user and the surrounding people when these instructions are ignored and the product is mishandled.

Type and meaning of symbols

	Prohibited actions that must not be attempted, in order to use this radio safely. For example,  signifies that disassembly is prohibited.
	Precautions that must be adhered to in order to use this radio safely. For example,  signifies that the power supply is to be disconnected.

DANGER



Do not use this product while driving or riding a motorbike. This may result in accidents.

Make sure to stop the car in a safe location first before use if the device is going to be used by the driver.



Do not touch any liquid leaking from the liquid display with your bare hands.

There is a risk of chemical burns occurring when the liquid comes into contact with the skin or gets into the eyes. In this case, seek medical treatment immediately.

WARNING



Do not dismantle or modify the device.
This may result in injury, electric shock and equipment failure.

When smoke or strange odors are emitted from the radio, turn off the power and disconnect the power cord from the socket.

This may result in fire, liquid leak, overheating, damage, ignition and equipment failure. Please contact our company amateur customer support or the retail store where you purchased the device.



Do not handle the power plug and connector etc. with wet hands. Also do not plug and unplug the power plug with wet hands.

This may result in injury, liquid leak, electric shock and equipment failure.



Keep the power plug pins and the surrounding areas clean at all times.

This may result in fire, liquid leak, overheating, breakage, ignition etc.

Safety Precautions



Please do not use a voltage other than the specified power supply voltage.
Doing so could cause fire, electric shock or damage to the equipment.



Do not install in places where the unit risks getting wet (such as near a humidifier).
Doing so may result in fire, electric shock or damage.



Do not use a power supply cable other than the one provided.
Doing so could cause fire, electric shock or damage to the equipment.



Do not place heavy objects on the power supply cable or connection cable, forcibly bend, twist or pull on the cables, or heat or modify them.
Doing so may scratch or damage the cables, resulting in fire, electric shock or damage to the equipment.



Do not pull on the cable section when disconnecting the power supply cable or connection cable.
Doing so could cause fire, electric shock or damage to the equipment. Hold the plug or the connector when disconnecting the cable.



Do not use the power supply cable or connection cable if it is damaged or if the connection of the power connector is loose.
Doing so could cause fire, electric shock or damage to the equipment. Contact your dealer or our customer support.



CAUTION



Do not place the unit on an unstable place or a place subject to much vibration.
The unit may fall or tip over, resulting in fire, injury or malfunction.



Do not place heavy objects on top of the unit.
The unit may fall or tip over, resulting in injury.



Do not place objects containing water, such as vases, cosmetics or cups, on top of the unit.
The water may spill and get inside the unit, resulting in fire or malfunction.



Do not place small metal objects such as clips on top of the unit.
The object may get inside, resulting in fire or malfunction.



Do not place the unit in humid or dusty places.
Doing so could cause fire or malfunction.



Do not use the headphones at high volume.
Listening to continuous loud sound over the headphones may damage the ears.



When using the headphones, lower the volume to the minimum before turning on the power.
Failure to do so may cause hearing disorders.



Do not wipe the case with thinner or benzene.
Use a soft, dry cloth to wipe dirt off the case.



Do not drop the unit or subject it to strong shocks.
Doing so could cause injury or malfunction.



For the sake of safety, disconnect the power supply cable when not planning to use the unit for a prolonged period.



Do not lift the unit holding on to the dial or another knob.
Doing so could cause damage to knob, panel, substrate, etc.



Disconnect the power supply cable and all cables connecting the unit to the radio before moving the microphone.



Do not place the unit in places exposed to direct sunlight or near heating appliances.
Doing so could cause deformation, discoloration, etc.



Store in a place out of the reach of small children.
Failure to do so could result in injury, etc.



Do not use products other than those specified by Yaesu.
Doing so may result in malfunction.

Controls & Connections

On Air Indicator

This illuminates in red when in TX mode.
The indicator is off when in RX mode.

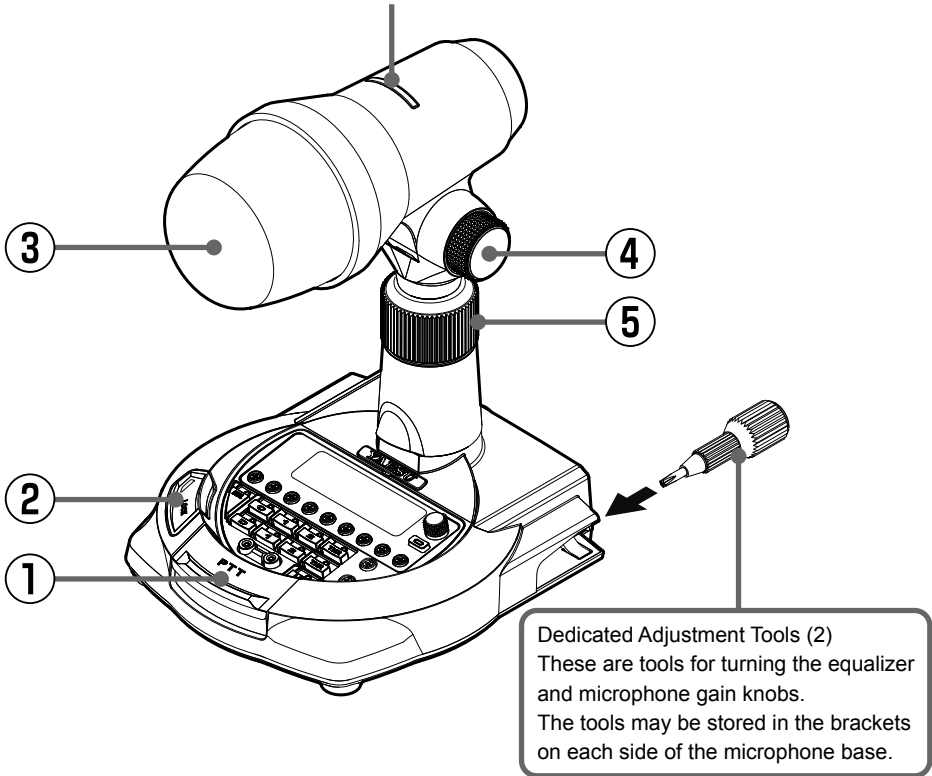

① PTT key

Press and hold down this key to transmit, and release it to receive.

- The PTT key operating selector switch on the bottom of the base unit may be switched to the "HOLD" side. Then when the PTT key is pressed briefly, the TX mode will be held until the PTT key is pressed again.

Caution: The PTT key has a built in the magnetic sensor. Strong magnetic items, such as a speaker or a magnet, may affect this PTT key, resulting in malfunctions.

② LOCK key

This is a one touch PTT key with a lock function.

When the LOCK key is pressed, the transmit mode is set and held, When the key is pressed again the transceiver returns to receive mode again.

- Operation of the PTT key is disabled when the LOCK key is operated.
- The LOCK key indicator lights up red when the LOCK key is in operated.

③ MIC

The unit includes a built-in dynamic microphone and a condenser microphone that are developed for communications equipment. The condenser microphone provides crisp sound with transparent frequency characteristics up to high frequencies. The dynamic microphone produces a thick, deep, warm sound quality that is suited for informal chatting. These two types of microphones are each equipped with an independent 9-band graphic equalizers, allowing the output frequency characteristics of the separate elements to be precisely controlled. It is also possible to combine the audio output signals from the two microphone elements.

- The included treble boost cowling may be installed to block sounds from the sides of the microphone, resulting in unique frequency characteristics as if the sound were condensed with a peak response in the vicinity of 1 to 1.5 kHz. To install the cowling, press it straight on from the front to cover the microphone. To remove, slide it straight off.

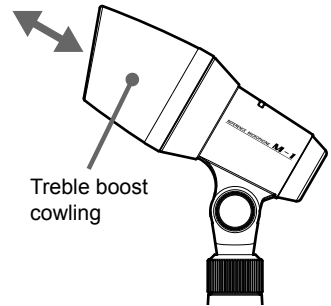

④ Angle adjustment knobs

The angle of the microphone may be adjusted by loosening (turn counterclockwise) the knobs on the left and right side of the pivot top. Place the microphone in the desired position and then tighten the knobs (turn them clockwise) to secure the microphone.

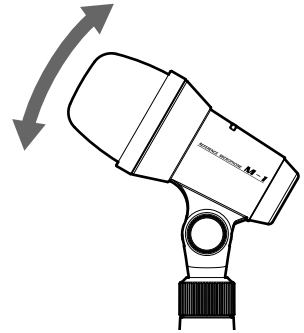

⑤ Height adjustment ring

The height of the microphone can be precisely adjusted. Turn the compression ring counterclockwise to loosen the top tube, and then raise or lower the top section to the desired position. Turn the compression ring clockwise to tighten it and hold the microphone in place.

- The stand can be extended a maximum of 6 cm.

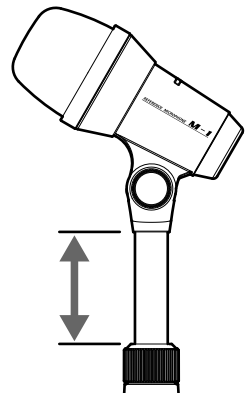

Controls & Connections

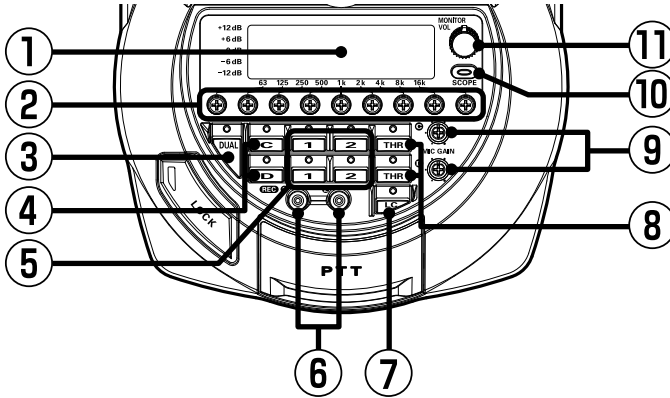

① Display

The display alternates between the Graphic Equalizer and the Real-time Scope displays, as shown below, each time the [**SCOPE**] key is pressed.

Graphic equalizer display

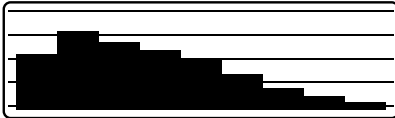

Illustrates the values of the currently selected 9-band graphic equalizer.

Real-time audio scope display

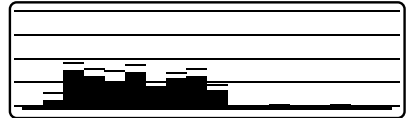

Microphone audio input displayed in an 18-band spectrum, from 44.2Hz to 16kHz.

② Graphic equalizer adjustment knobs

The output signals of both the condenser microphone and the dynamic microphone can each be adjusted in 9 frequency bands to achieve the desired sound.

- Use the included dedicated adjustment tool to turn each adjustment knob.
- The 9 adjustable frequency bands are listed below.

63 Hz, 125 Hz, 250 Hz, 500 Hz, 1 kHz, 2 kHz, 4 kHz, 8 kHz, 16 kHz
 ◀ Bass Treble ▶

- Settings emphasizing the low range are factory preset into memory 1, Settings emphasizing the high range are factory preset into memory 2.

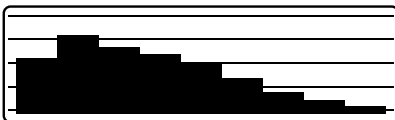

Memory 1

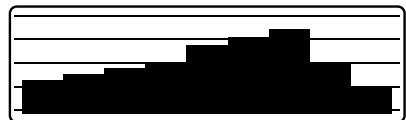

Memory 2

Adjusting

- Press the [**SCOPE**] key to enable the graphic equalizer display mode.
 - The [**SCOPE**] key LED is OFF while the graphic equalizer mode is displayed.
- Press the number [**1**] or [**2**] key to select the desired memory.

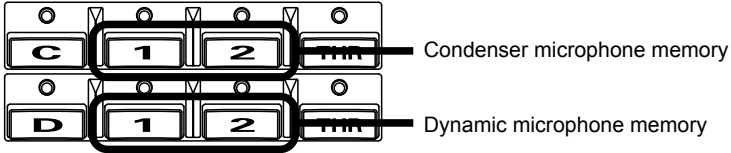

- The selected memory number will be illuminated in blue.
- Turn the graphic equalizer setting knobs below the display, using the included adjustment tool. Fine-tune each individual audio band to the desired sound quality.

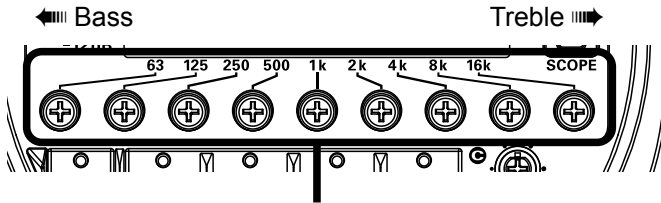

Graphic equalizer setting knobs

- The 9 frequency bands can be adjusted in steps of 0.5 dB.
- The adjusted values are stored to the memory in real time.
- The transmitted sound also depends on the frequency characteristics of the transceiver.

③ DUAL key

When this key is pressed, the audio outputs from both the capacitor microphone and the dynamic microphone are blended together.

- The [**C**] or [**D**] button will light in red for the microphone selected before the DUAL key was pressed. The other microphone button will light in orange.
- The [**1**] or [**2**] or [**THR**] buttons will also be illuminated.

④ C/D key

These keys switch between the condenser microphone and the dynamic microphone.

[**C**] key: Switches to the condenser microphone ([**C**] LED lights up red)

[**D**] key: Switches to the dynamic microphone ([**D**] LED lights up red)

- When the DUAL key is pressed, the two microphones operate simultaneously.

Controls & Connections

⑤ Equalizer memory keys

When the [1] or [2] key is pressed, the audio signal output from the M-1 microphone is tailored to the frequency characteristics stored in the respective memory.

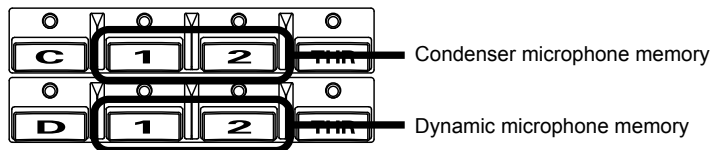

- Default settings emphasizing the low audio tones are preset in memory 1, settings emphasizing the high audio tones are factory preset in memory 2.



Memory 1



Memory 2

- The LED of the selected memory, [1] or [2], lights blue.
- The frequency characteristics can be fine-tuned for each individual audio band by turning the graphic equalizer adjustment knobs.
- The current frequency characteristics can be copied into memory [1] or [2] by pressing and holding the appropriate key for one second.

⑥ Recording/Playback key

Up to 20 seconds of audio can be recorded. The recorded content can be replayed using headphones connected to PHONES jack on the rear panel. The recording can be transmitted by replaying it during a transmission. In addition, The M-1 may be configured to automatically transmit the recorded content when the audio memory is replayed (see “Automatically Transmit the Recorded Message” below).

Recording

- Press [1] or [2] for one second or more to start recording.
 - During recording, the [1] or [2] LED lights up red.
- To stop recording, press the [1] or [2] key again, recording will automatically stop after 20 seconds.

Playback (While not transmitting)

1. The recording is played when the [1] or [2] key is pressed.
 - The recording can be heard over the headphones connected to the PHONES terminal on the rear panel.
 - The volume can be adjusted with the MONITOR VOL knob.
 - During playback, the [1] or [2] LED lights up blue.
 - The recording can be transmitted by pressing the [1] or [2] key during transmission.
2. Press the [1] or [2] key to stop playback.

Playback (Automatically Transmit the Recorded Message)

1. Turn the Microphone OFF.

NOTE: when the M-1 POWER switch is set to “AUTO”, The M-1 power will turn ON/OFF in conjunction with the power switch on the transceiver.
2. Press and hold in the [1] key while turning the Microphone ON.
 - Once the Microphone comes on, release the key. A long beep will sound.
3. The recording will be played and transmitted when the [1] or [2] key is pressed.
 - The recording can also be heard over the headphones connected to the PHONES terminal on the rear panel.
 - The volume can be adjusted with the MONITOR VOL knob.
 - During playback, the [1] or [2] LED lights up blue.
4. When the playback transmission ends, the transceiver will return to the receive mode.
 - During the playback transmission, press the [1] or [2] key to stop the playback.

To cancel the “Automatic Recorded Message Transmit” operation, repeat steps 1 and 2 above.

- Once the Microphone comes on, release the key. A short beep will sound.

⑦ **LC (Low Cut) key**

When this key is pressed, a low-cut filter (cut-off frequency 200Hz, -6dB/octave) is activated. This low-cut filter is independent of the equalizer.

⑧ **THR (THRU) key**

When this key is pressed, the graphic equalizer function is bypassed and the the microphone element audio is output directly without being altered.

- In the through mode, the [THR] button lights white, the [1] and [2] buttons are not lit.

Controls & Connections

⑨ MIC GAIN adjustment knobs

The output gain of the condenser microphone and the dynamic microphone may be adjusted individually by turning the MIC GAIN control knobs using the included adjustment tools.

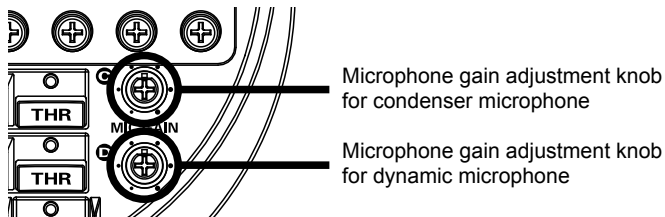

- Turn the control knobs with the included adjustment tool.
- The microphone gain increases when the control is turned clockwise (to the right).
- In the DUAL mode, the audio from the two microphone elements is combined. The optimum mix can be achieved by adjusting the microphone gain controls.
- Usually the controls are turned fully clockwise (to the right), but a lower microphone gain may be desired, for example when the surrounding noise is high.

⑩ SCOPE key

Pressing the [SCOPE] key changes the screen between the equalizer settings and the real-time audio scope display.

- The [SCOPE] key lights up orange when the real-time audio scope is displayed, and is off when the equalizer is displayed.

⑪ MONITOR Volume knob

The Monitor Volume Knob adjusts the level of the audio in the headphones connected to the PHONES terminal on the rear panel.

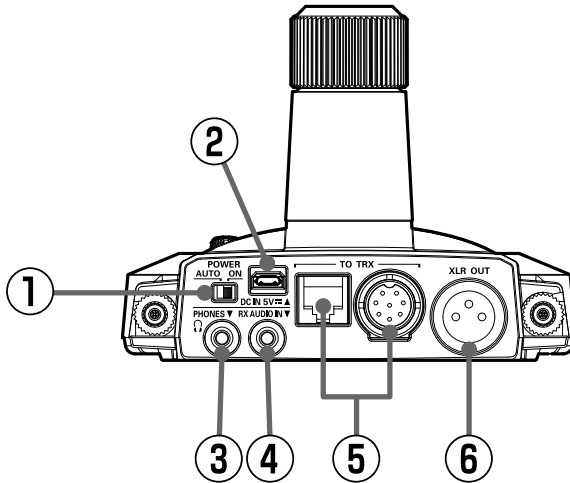

① POWER Switch

Position this switch for the desired operation of the M-1 power.

AUTO: The M-1 power turns ON/OFF together with the power of the radio.

ON: The M-1 power is always ON.

② DC IN 5V Jack

Use the included power cable to connect to the included AC adapter.

- The FT-991A and FT-891 can supply the needed power from the microphone connector. By switching an internal slide switch (S1004), it is not necessary to use the AC adapter. Please contact YAESU Technical Support for setting the internal slide switch.

Note: Do not connect any power cables or any AC adapters other than those provided with this microphone.

③ PHONES Jack

This jack is used to connect commercially available stereo headphones (3.5 mm jack).

Headphones can be used to monitor your own voice and recorded content. Also, the transceiver audio may be monitored by connecting the RX AUDIO IN terminal to the radio.

- Use the MONITOR VOL knob to adjust the headphone audio volume level.

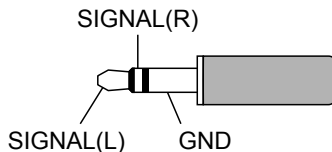

Controls & Connections

④ RX AUDIO IN Jack

The audio from a transceiver can be monitored with the headphones by connecting. The transceiver audio output to this input jack.

- Use a 3.5 mm mono plug to connect to the transceiver headphone or speaker jack.

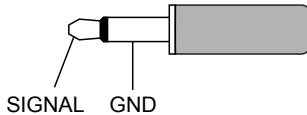

⑤ MIC Jack

Connect to the transceiver microphone terminal using the included microphone cable.

- If the transceiver microphone jack is an 8-pin terminal, connect the microphone cable to the M-1 microphone's modular terminal.
- If the transceiver microphone jack is a modular connector, connect the microphone cable to the M-1 microphone's 8-pin terminal.

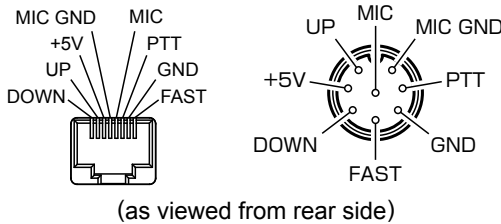

⑥ Cannon (XLR) Microphone Connector

This is a balanced type Cannon connector of the type widely used in professional equipment (XLR type). It reduces the influence of external electrical noise, and maintains high quality audio signals.

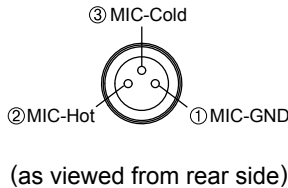

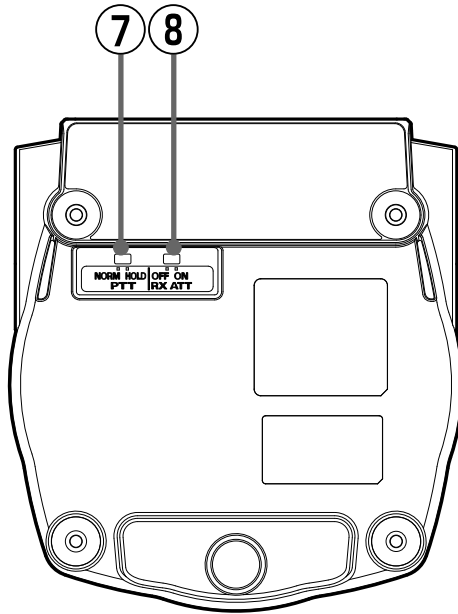

⑦ PTT key operation selector switch

Position this switch for the desired operation of the PTT key as shown below:

NORM: Transmit is active only while the PTT key is pressed. The transceiver returns to receive mode when the PTT key is released.

HOLD: When the PTT key is pressed briefly, the transmission mode is set and held. The transceiver returns to receive mode when the PTT key is pressed again.

⑧ RX ATT switch

If the transceiver audio output level is too high, move this switch to ON. The audio signal input to the rear panel RX AUDIO IN terminal will be attenuated by 20dB. Normally use the M-1 with this switch set to OFF.

ON: The input audio signal is attenuated.

OFF: The input audio signal is not attenuated.

Convenience Functions

Setting the Display Contrast

1. Turn the Microphone OFF.

NOTE: when the M-1 POWER switch is set to "AUTO", The M-1 power will turn ON/OFF in conjunction with the power switch on the transceiver.

2. Press and hold in the [LC] key while turning the Microphone on.

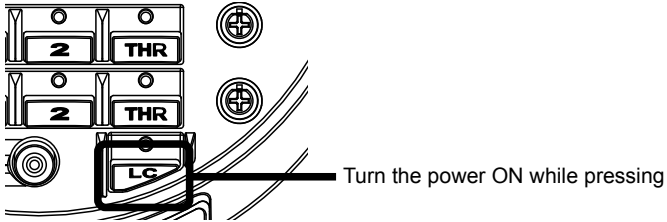

3. Use the included adjustment tools to turn the 63 Hz graphic equalizer setting knob and adjust for the desired contrast.

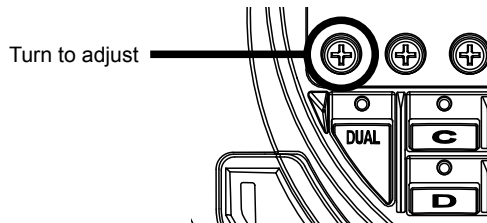

4. When the contrast adjustment is satisfactory, turn the power OFF, and then back ON.

Reset

ALL Reset

This procedure resets all the graphic equalizer defaults and clears the recorded contents, restoring the M-1 microphone to the factory default status.

1. Turn the Microphone OFF.

NOTE: when the M-1 POWER switch is set to "AUTO", The M-1 power will turn ON/OFF in conjunction with the power switch on the transceiver.

2. Press and hold in the [C] and [D] keys while turning the M-1 Microphone ON.

Once the Microphone comes on, release the keys.

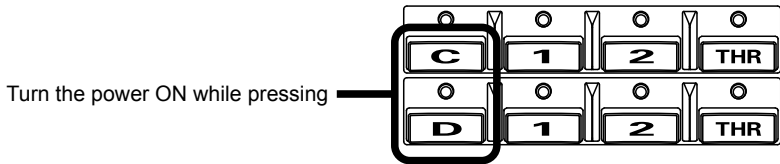

3. When reset is completed, the [C] (red) and [1] (blue) LEDs will light up.

Resetting the graphic equalizer

This procedure only resets the graphic equalizer defaults. The recorded contents are not reset.

1. Turn the Microphone OFF.

NOTE: when the M-1 POWER switch is set to "AUTO", The M-1 power will turn ON/OFF in conjunction with the power switch on the transceiver.

2. Press and hold in the [DUAL] key while turning the M-1 Microphone ON.

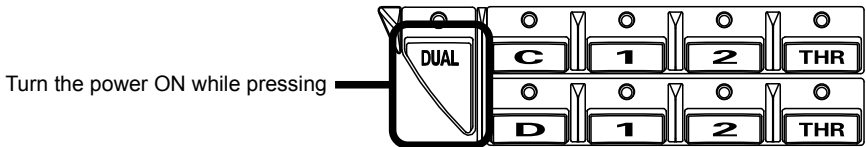

Frequency characteristics of the microphone

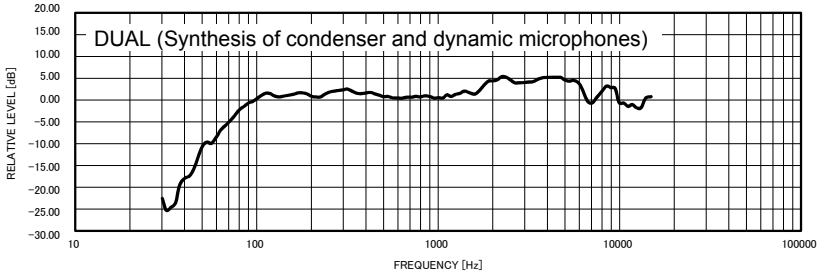
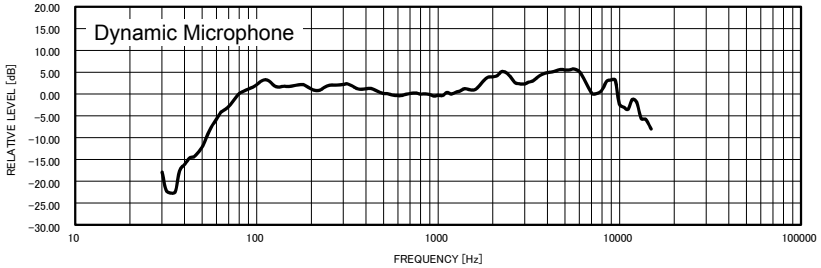
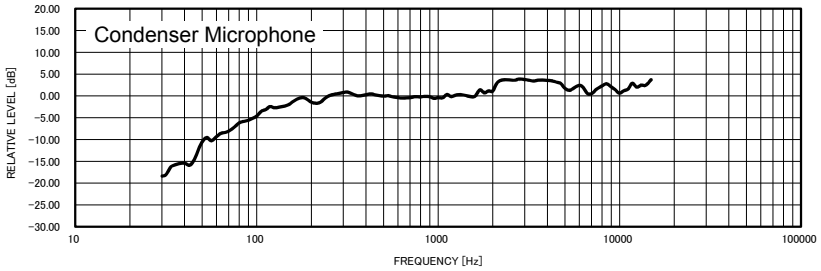

※ These frequency characteristics may vary depending on the measurement environment.

Specifications

Microphone Type:	Dynamic microphone / Condenser microphone
Supply Voltage:	DC 5.0 V \pm 5 %
Current Consumption:	160 mA \pm 30 mA (TYP)
Frequency Response:	30 - 17000 Hz
Sensitivity:	-60 dB (1 kHz 0 dB=1V/1Pa)
Microphone Impedance:	600 Ohms
Headphone Output Impedance:	16 Ohms (TYP)
Headphone Output Level:	15 mW (TYP)
RX AUDIO IN (Input Level):	100 mVrms (TYP)
Dimensions (WxHxD):	5.5" x 11.0" x 6.0" (140 x 280 x 152 mm) *H: Maximum with microphone flat
Weight (approx):	2.11 lbs (960 g) w/o cable

Declaration of Conformity

Nr. YUK-DOC-1001-16

We, Yaesu UK Ltd, certify and declare under our sole responsibility that the following equipment complies with the essential requirements of the Directive 1999/5/EC and 2011/65/EU.

Type of Equipment	Reference Microphone
Brand Name	YAESU
Model Number	M-1
Manufacturer	YAESU MUSEN CO. LTD.
Address of Manufacturer	Tennozu Parkside Building, 2-5-8 Higashi-Shinagawa, Shinagawa-ku, Tokyo, 140-0002 Japan

Applicable Standards:

This equipment is tested to and conforms to the essential requirements of directive, as included in following standards:

Safety 1999/5/EC Art. 3 (1) (a)	EN 60950-1:2006 + A2:2013
EMC 1999/5/EC Art. 3 (1) (b)	EN 61000-6-1:2007
	EN 61000-6-3:2007 + A1:2011
ROHS2 2011/65/EU Art. 7 (b)	EN 50581:2012

The technical documentation as required by the Conformity Assessment procedures is kept at the following address:

Company
Address
Technical Construction file

Yaesu UK Ltd
Unit 12, Sun Valley Business Park, Winnall Close

Winchester, Hampshire UK SO23 0LB
Issued by: Yaesu Musen Co. Ltd, Tokyo Japan
File No: YETA00420
Drawn up in: Winchester, Hampshire UK
Date: 17th October 2016

Signed for and on behalf of Yaesu UK Ltd



Name and position: PCJ Bigwood
Technical Sales Manager

Copyright 2016
YAESU MUSEN CO., LTD.
All rights reserved.

No portion of this manual may be reproduced without the permission of YAESU MUSEN CO., LTD.

Disposal of your Electronic and Electric Equipment

Products with the symbol (crossed-out wheeled bin) cannot be disposed as household waste. Electronic and Electric Equipment should be recycled at a facility capable of handling these items and their waste by products.

In EU countries, please contact your local equipment supplier representative or service center for information about the waste collection system in your country.



YAESU

The radio

YAESU MUSEN CO., LTD.

Tennozu Parkside Building
2-5-8 Higashi-Shinagawa, Shinagawa-ku, Tokyo 140-0002 Japan

YAESU USA

6125 Phyllis Drive, Cypress, CA 90630, U.S.A.

YAESU UK

Unit 12, Sun Valley Business Park, Winnall Close
Winchester, Hampshire, SO23 0LB, U.K.



1610L-AO-1
Printed in Japan

