

INSTRUCTION MANUAL

FL DX 400

M. G. FARMER
20 STANLEY STREET,
PLYMPTON 5038

YAESU MUSEN CO., LTD.

TOKYO JAPAN

186.087

GENERAL

The model FLdx400/500 SSB Transmitter is a precision built, compact, high performance desk top SSB transmitter with CW, AM, LSB and USB modes of operation. FSK operation can be installed with minor modification. On all modes, except AM, this transmitter works at an input of 240 watts on all bands through 80 to 10 meters. The AM mode consists of transmitted carrier and one sideband. The SSB is generated by a MECHANICAL FILTER.

SPECIFICATIONS

Type of emission	CW, AM, SSB (upper/lower selectable), FSK option
Operation	VOX, PTT (push-to-talk), and MOX
Power input	240 watts PEP SSB & CW. 75 Watts AM
Output impedance.....	50 to 120 ohms
Frequency range	3.5-4.1MHz, 6.9-7.5MHz, 13.9-14.5MHz, 20.9-21.5MHz, 27.9-28.5MHz, 28.5-29.1MHz, 28.9-29.5MHz, 29.5-30.1MHz.
Frequency stability	100 Hz after warm-up for 10% drift of line voltage.
Carrier suppression	50 db below peak output
Sideband suppression	50 db below peak output at 1000 Hz
Distortion product	better than 30 db
Audio response	6 db at 300 to 2700 Hz
Power requirement	100/110/200/220/234 V AC 50/60 cps, 350 watts
Cabinet size	6 ¹ / ₂ " Hight, 14 ¹ / ₂ " Wide, 11 ¹ / ₂ " Deep
Net weight.....	18 Kgs/35 lbs

TUBE AND DIODE COMPLEMENT

6AN8	1 speech amplifier	6U8	1 carrier OSC. & antitrip amplifier
1S1007	4 balanced modulator	12AU7	1 sideband oscillator
6U8	1 VOX amplifier, relay	6BA6	1 IF amplifier
SH-1	2 antitrip rectifier	6CB6	1 VFO mixer
12AT7	1 sideband mixer	6JS6C	2 linear amplifier
6AW8A	1 heterodyne osc. & mixer	SD-1	4 rectifier
12BY7A	1 driver	SH-1	2 automatic level control
SH-1	1 bias rectifier	3SK22G	2 VFO and buffer
1S1007	1 output rectifier	2SC372	1 VFO amplifier

IMPORTANT

Do not operate the equipment before you are completely familiar with the instructions in this manual. The block diagram and circuit description will provide you with a better understanding of this transmitter.

BLOCK DIAGRAM

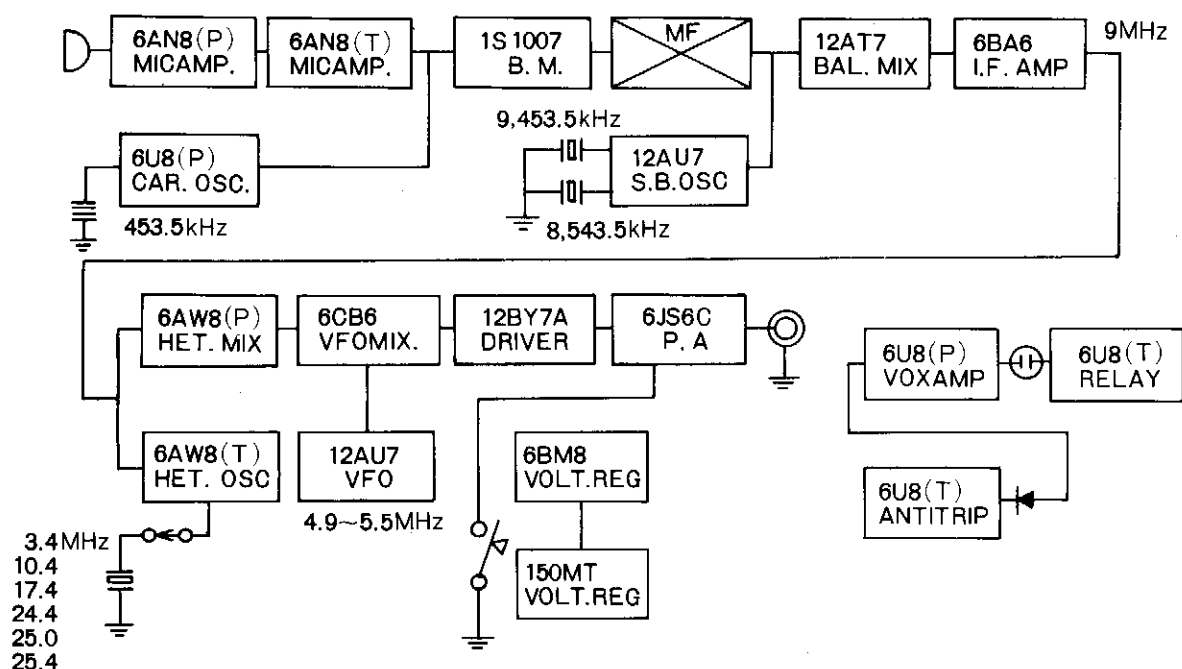

CIRCUIT DESCRIPTION

(1) SPEECH AMPLIFIER, CATHODE FOLLOWER

The pentode section of a 6AN8 tube is used as a speech amplifier. The amplified speech signal is coupled through the MIC GAIN control to the grid of the cathode follower, triode section of the same tube. A cathode follower circuit is used to match the low impedance of the diode balanced modulator. These circuits are inoperative in CW operation and SPOT.

(2) VOX AMPLIFIER, ANTITRIP AMPLIFIER, RELAY CONTROL

The speech signal is amplified and its output is coupled to the grid of a pentode section of 6U8, the VOX amplifier through the VOX GAIN control. The signal thus amplified is then fed to the neon lamp which conducts with speech signal to deliver positive voltage to the control grid of relay tube. This DC voltage is directly coupled to the grid of the relay control tube to control the relay with the speech signal. The relay control tube is cathode biased by VR5 $3K\Omega$, R-28 100Ω to cut-off without DC voltage which is applied to the grid by speech signal. In PTT (push-to-talk) operation, the cathode of this tube is grounded through a 100 ohm resistor, by a switch on the microphone. On VOX OFF position, the cathode is also grounded through a 100 ohm resistor which closes the relay. The audio signal from the station receiver is coupled to the antitrip amplifier tube through the ANTITRIP control. Amplified signals are then rectified which makes the grid of the VOX amplifier tube positive, the tube conducts to lower its plate voltage, and prevent the relay from activation by the audio signal from the station receiver. In CW operation, 6.3 volts AC is applied to the grid of the VOX amplifier tube through the VOX GAIN control and a 270 K ohms resistor for BREAK-IN CW operation. The DELAY control on the front panel adjusts the dropout time of the relay.

(3) CARRIER OSCILLATOR, BALANCED MODULATOR, MECHANICAL FILTER

The carrier oscillator utilizes the pentode section of a 6U8 tube. Frequency is controlled by a quartz crystal matched to the MECHANICAL FILTER to place the carrier at a point which provides proper audio response and excellent carrier suppression. The balanced modulator circuit consists of four matched diodes with a carrier null potentiometer. A trimmer capacitor is used in conjunction with the potentiometer to balance out external circuit capacity. A MECHANICAL FILTER is used for the generation of the single sideband. Excellent carrier and unwanted sideband suppression is obtained through the use of the MECHANICAL FILTER.

(4) SIDEBAND MIXER, SIDEBAND OSCILLATOR

The upper sideband generated by the balanced modulator and the mechanical filter is then fed to the grid of the sideband mixer tube 12AT7. This balance mixer mixes the 455kHz upper sideband signal with either 8543.5kHz or 9453.5kHz signal from the sideband oscillator. The sum of the 455kHz and 8543.5kHz produces the upper sideband 9MHz IF signal. The difference between the 455kHz and 9453.5kHz produces the lower sideband 9MHz IF signal. The sideband oscillator tube is a dual triode tube 12AU7, each section of which is used in a Colpitts circuit. The sideband is selected from the front panel by the MODE switch which removes blocking bias from the oscillator tube. The crystal frequency is adjusted by a trimmer capacitor to set the carrier on frequency.

For FSK operation, 9453.5kHz oscillator frequency is shifted with parallel connected varicap diode which is keyed by RTTY key board.

(5) INTERMEDIATE FREQUENCY AMPLIFIER

The 9MHz IF signal is coupled, through an IF transformer, to the grid of the IF amplifier tube 6BA6. IF transformer L3 and L4 are double tuned to pass only a 9MHz signal. This stage is controlled by the automatic level control bias voltage which is delivered from the grid circuit of the final linear amplifier to prevent overdrive. The Cathode circuit is connected through a switch to the meter and reads ALC performance. ALC voltage applied to the grid decreases the plate current of this tube.

(6) HETERODYNE MIXER, HETERODYNE OSCILLATOR

The pentode section of a 6AW8A tube is used as a mixer to combine the sum of the 9MHz IF signal and the heterodyne oscillator signal from the triode section of the same tube. The grid circuit of this mixer is grid-block-keyed for CW operation.

The frequency relation between mixer plate tuning circuit and crystal oscillator is as follows:

BAND	CRYSTAL OSC.	MIXER PLATE
80 meters	not in operation	Untuned, resistance coupled to 9 MHz
40 "	3.4 MHz ✓	12.4 MHz
20 "	10.4 MHz ✓	19.4 MHz
15 "	17.4 MHz ✓	26.4 MHz
10A "	24.4 MHz ✓	33.4 MHz
10B "	25.0 MHz ✓	34.0 MHz
10C "	25.4 MHz ✓	34.4 MHz
100 "	26.0 MHz	35.0 MHz

For the auxiliary band operation, the heterodyne crystal frequency in MHz is calculated as follows;

$$X = \text{band frequency} + 5.4 - 9 \text{ MHz}$$

The band frequency is every megahertz and 500kHz.

For example, the heterodyne crystal frequency to cover 14.832MHz is calculated as follows;

$$X = 14.5 + 5.4 - 9 = 10.9 \text{ MHz}$$

(7) VFO MIXER, VFO OSCILLATOR

As a VFO mixer, a 6BC6 is used to combine heterodyne mixer output and VFO signal which is delivered from the VFO tube, 12AU7. The difference between the two is now the transmitted frequency. The temperature compensated VFO circuit will provide excellent frequency stability. External VFO can be used by a switch for Transceive or fixed crystal controlled operation.

(8) DRIVER, FINAL LINEAR AMPLIFIER

The driver stage uses a 12BY7A tube as a linear voltage amplifier. The grid of this stage is biased to cut-off as stand-by, and the bias is removed by the keying or transmitting. The final linear amplifier utilizes two 6JS6C as class AB linear amplifier. This tube has high power output with a relatively low plate voltage. The amplifier is neutralized by the capacitive bridge system with a variable capacitor connected from the plate of the tube to the bottom of the grid circuit. The grid of this tube is also biased to cut-off in stand-by and correct bias is supplied for transmit. The amplifier output is a shunt fed pi network capable of working into 50 to 120 ohm load on all bands.

The output side of the pi network is connected to a diode rectifier through the voltage divider to measure the relative power output. In SSB operation, the automatic level control is connected to the grid circuit to prevent overdrive. When RF drive voltage to the final tubes becomes sufficient to drive the grids positive, the grids begin to draw current and the signal is detected. This produces an audio envelope. The audio is rectified by the ALC rectifier, which in turn produces a negative DC voltage. The voltage is filtered and is used to control the gain of V3. The ALC voltage controls the gain of V3 and is grounded by the MODE switch in CW. The ALC voltage is also grounded by the MODE switch in TUNE positions. This system allows a high average level of modulation without distortion.

(9) POWER SUPPLY

Four silicon diodes are used for the high voltage rectifier instead of the conventional rectifier tube to improve the voltage regulation and for overall efficiency. 600 volts is available for the final plate supply and 300 volts for the low voltage circuits, screen grids of the final tube and the plate supply for VFO, sideband oscillators are stabilized by a 6BM8 tube. Carrier oscillator and heterodyne oscillator supply is regulated by a gas diode VR-150MT. The power transformer has five windings including two primary windings. Connecting the primary in parallel or series, provides 100 volts or 220 volts operation possible.

(10) METERING, OPERATION SWITCH, ACCESSORY SOCKET

Metering is provided by a milliammeter connected to the meter switch which selects final cathode current, ALC and relative power output. The operation switch changes the bias voltage for each stage as follows:

TUBE	OPERATION	STAND-BY	SPOTTING
6AW8A	0 volts	-60 volts	0 volts
6CB6	"	"	"
12BY7	"	"	"
6JS6C	-40 volts approx.	"	-60 volts

Accessory socket provides the following functions;

pin		
1	+150V	
2	FSK input	
3	antitrip input from the station receiver	
4	connect to pin 5 on stand-by	
5	connect to pin 4 on stand-by and pin 6 on transmit, grounded	
6	connect to pin 5 on transmit	
7	connect to ground on receive	
8	connect to ground on receive	
9	ground	

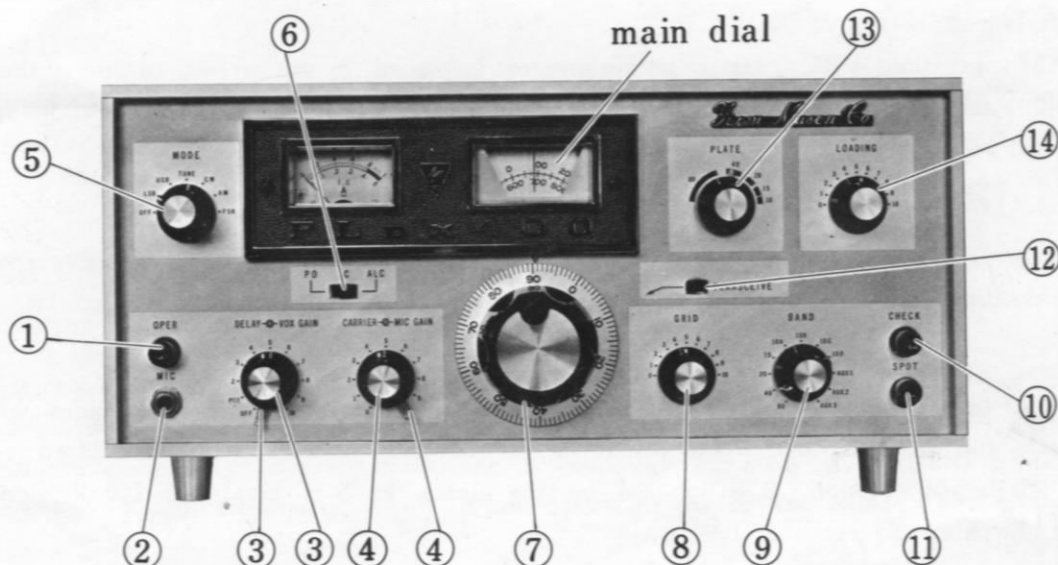

OPERATION

FUNCTION OF OPERATING CONTROLS

(1) OPER

With OPER switch pushed-in, voltage is supplied through the relay winding to the relay tube and the transmitter is ready to operate. For stand-by, push the switch to release from OPER condition.

(2) MIC

The microphone jack has three connections, these are, microphone input, push-to-talk circuit and ground connection. High impedance microphone should be used.

(3) DELAY/VOX GAIN

These controls set the operation level for the VOX relay; center knob controls input voltage for the VOX amplifier tube. In the OFF position, the cathode bias for the relay tube is removed to close the relay for manual operation with operation switch. On the PTT position, the relay does not work with speech, and thus push-to-talk operation is possible by removing cathode bias by a switch on microphone.

Outer lever is used to adjust the holding time of the relay for VOX and break-in CW operation. The hold time increases with clockwise rotation.

(4) MIC GAIN/CARRIER

The MIC GAIN control varies the audio level of the microphone amplifier. The control has sufficient range to permit the use of any high-level crystal microphone or low level dynamic microphone. The outer control is used to insert carrier for AM operation.

(5) MODE

This switch is used to select the mode of operation. In OFF position, the line voltage to transceiver is completely off. Sideband is selected by removing the blocking bias from the appropriate oscillator. In the TUNE and CW positions, the USB oscillator is used and the audio signal to the balanced modulator and ALC voltage are shorted to ground, and carrier is supplied to the grid of a balanced mixer, V2 12AT7.

For AM operation, VR6, carrier potentiometer is placed in the circuit to adjust the carrier level. FSK circuitry is not wired in original equipment. The necessary information for FSK operation will be furnished through your dealer.

(6) IC-PO-ALC

The meter is selected to measure the total cathode current at IC position, relative power output at PO position, and ALC level at ALC position, and ALC level at ALC position.

(7) VFO

The VFO tuning consists of two dials. The main dial has two calibrated scales which are coloured red and black to match the colour of the band indicated on the BAND switch. The scales are 25kHz per division. The sub-dial on the tuning knob is divided in 100 divisions and 1 division is approximately equal to 1 MHz.

(8) GRID

The control is used to tune the plate circuit of the VFO mixer and driver stages.

(9) BAND

This control is used to select the amateur band upon which operation is desired, the 10 meter band is covered in 4 sections.

BAND	FREQUENCY RANGE	DIAL COLOUR
80 meters	from 3500 to 4100 kHz	red
40 "	6900 7500	black
20 "	13900 14500	black
15 "	20900 21500	black
10A "	27900 28500	black
10B "	28500 29100	red
10C "	28900 29500	black
10D "	29500 30100	red

(10) CHECK

The switch can be used to use the transmitter VFO to listen to any other frequency than operating frequency in the bands while the transmitter is used in transceive operation.

(11) SPOT

By pressing this switch, the blocking bias except to the final PA tubes is removed and a weak signal is transmitted to spot the frequency on the station receiver.

(12) TRANSCEIVE

This switch is used for the transceive operation in conjunction with our FR-receiver.

(13) PLATE

This control is used to tune the output circuit of the final linear amplifier, approximate tuning area for the bands is shown on the panel.

(14) LOADING

This control is used to match the output impedance of the pi network to feeder impedance.

INSTALLATION

It is recommended to avoid an excessively warm location. The transmitter should be placed with adequate space around it permitting free air circulation through the cabinet openings. This transmitter is designed to operate on either 100 volts or 220 volts AC 50/60 Hz. Check the AC mains voltage of your transmitter prior to connection to power line outlet. The peak power consumption is approximately 350 watts.

(1) INITIAL CHECK

Prior to connecting to power outlet, carefully examine for any visible damage, check that all tubes and crystals are properly seated in their sockets, and check tuning controls and switches for complete freedom of action. Connect a dummy load to the coaxial cable connector.

Set the MODE switch to OFF position. Make sure that supply voltage is the same as the voltage marked on the rear apron of the chassis before connecting to power outlet. Set the controls as follows:

OPER:	release position.
DELAY:	fully counterclockwise.
VOX GAIN:	OFF.
MIC GAIN:	fully counterclockwise.
PO/IC/ALC:	IC.
MAIN TUNING DIAL:	250kHz(center of the scale).
TRANSCEIVE:	fully left side position.
GRID:	5.
BAND:	20 meter.
PLATE:	20 meter portion.
LOADING:	0.

Connect AC cable to the power outlet. Set the MODE switch to USB, and wait for warmup. Push the OPER switch. Then the meter will indicate PA cathode current. It should be approximately 50 ma. If the cathode current is other than 50 ma, adjust BIAS potentiometer under top cover. Turn meter switch to the ALC position, and adjust ALC potentiometer under the top cover until meter reading shows exactly full scale. Set the MODE switch to TUNE position, and CARRIER control to position 5, then tune the GRID control to peak IC reading. Tune the PLATE tuning for dip quickly. This procedure should be done quickly to protect the PA tubes, and release the OPER switch. Set the MODE switch to USB, press OPER switch and VOX GAIN to 5 position speaking normally into the microphone, adjust RELAY control under top cover to activate the relay with speech.

(2) ACCESSORY SOCKET CONNECTION

Connections from the socket to the station receiver and any other additional equipment which may be used are shown in figures and should be made as follows.

pin	1	+150V
pin	2	FSK input.
pin	3	to the station receiver voice coil or 600 ohms output.
pin	4	FR receiver Mute terminal.
pin	5	ground
pin	6	relay terminal of FL linear amplifier.
pin	7	relay terminal.
pin	8	relay terminal.
pin	9	ground.

See figure illustrated in the following page.

(3) GROUND

The chassis ground connection that is provided on the rear apron of the transmitter should be connected to an actual earth ground by a heavy lead. It is not recommended that gas pipes or electrical conduit pipes be used. This ground lead should be as short as possible.

(4) ANTENNA

The pi network output impedance is designed to match a 50 to 120 ohm feeder. Most commercial antennas and feeders are designed to operate between 50 and 75 ohms. If the impedance is far from this value, the use of an antenna matching device is recommended.

(5) RF OUTPUT

The RF driving voltage is furnished to operate this unit for VHF exciter in conjunction with our FTV650 transvertor.

(6) EXT. OSC

For transceive operation with our FR receiver, connect between this terminal and VFO OUT terminal of the receiver with coaxial cable.

(7) POWER OUT

All necessary power requirement for our transvertor is supplied from this socket. When transvertor is not used, keep the plug in the socket otherwise the heater supply for final tubes, 6JS6 is disconnected.

Connections from the socket to the transverter are as follows.

pin 1	no connection	pin 2	AC6.3V
pin 3	(+) 150V regulated	pin 4	(+) 300V
pin 5	(+) 600V	pin 6	(-) 100V
pin 7	ALC input	pin 8	ground
pin 9	relay	pin 10	no connection
pin 11	no connection		

Pin 1 and pin 2 is connected directly inside of the plug.

OPERATION

It will be assumed all connections are in place as illustrated in following page.

(1) CW OPERATION

Set the controls as follows:

OPER	release position.
BAND	desired band.
MIC GAIN	fully counterclockwise
MODE	CW

VOX GAIN	OFF
DELAY	fully counterclockwise
VFO	desired frequency
LOADING	9 o'clock position
PLATE	desired band area indicated

Turn on the power and wait for the set to warm up. Set the MODE switch to TUNE position. Tune the station receiver to the frequency selected. Pressing the SPOT switch down, tune the VFO to zero beat with receiving frequency. If the spotting signal is too weak to zero beat, tune the grid and plate tuning for the loudest beat. Push the operation switch down. Tune the GRID for maximum plate current and PLATE for dip. Increase the LOADING for maximum power output. Meter reading shows approximately 300 MA at IC position. Release OPER switch and set the MODE switch to CW position. These tuning procedures must be done quickly. The transmitter is now fully tuned for manual CW operation. For break-in operation, connect the key as illustrated. Advance the VOX GAIN control until the relay is closed by keying. Adjust the VOX DELAY control for the desired drop-out delay: delay time increases with clockwise rotation. RELAY control under the top cover should be adjusted to activate the VOX relay with VOX GAIN setting in mid-position when speaking into microphone normally.

(2) AM OPERATION

Set the MODE switch to the AM position. Tune up exactly as is described in the CW mode. Adjust the plate current to 150 ma with the CARRIER control under the top cover. Advance the MIC GAIN control till the plate current kicks up to 160 ma speaking into the microphone normally. In the case of PTT, place the VOX GAIN to PTT position. For VOX operation advance the VOX GAIN until the relay activates the transmitter instantly when speaking into the microphone. Adjust the station receiver gain control to the desired listening level. Advance the ANTITRIP control under the top cover clockwise until received signals do not actuate the VOX relay. Use no more antitrip gain than is necessary. For Push-to-talk operation the antitrip control may be turned off. This method of transmitting is the carrier and upper sideband system.

(3) SSB OPERATION

Tune up exactly as is described above and set the MODE switch to USB or LSB position. Increase audio gain until meter shows about 150 ma at average speaking levels. Operate as described in AM operation PTT or VOX modes. The VFO scale on the knob is adjustable. Move the scale by holding the knob firmly for correct calibration. Check meter reading is within green coloured scale to prevent overdrive at meter switch ALC position.

(4) TRANSCEIVE OPERATION WITH FRdx400/500 RECEIVER:

Connect the cables as shown in the illustration of following page.

Set the VFO SELECT switch on the transmitter to TRANSCEIVE position. Set the BAND switches to the desired band and both MODE switches to the same position. Tune the receiver and transmitter as in normal operation. Both transmitter and receiver frequency is controlled by the receiver VFO. Due to the frequency tolerance of the HF heterodyne crystals, it may be necessary to adjust the CLARIFIER control of the receiver to zero beat transmitting and receiving

frequencies. To do this it is best to use the MONITOR control of the receiver. Monitor the transmitted signal, and adjust the CLARIFIER control until the natural voice is heard.

If the transmitted frequency is changed by any great amount, be sure to redip the PA plate current and check the loading. It is possible to listen other frequencies than the operating frequency with the transmitter VFO by pressing down the CHECK control knob. Pressing this control down, the transmitter VFO voltage is introduced into the circuit to overlap the signals selected by the transmitter VFO.

DO NOT ATTEMPT OPERATION IN TRANSCEIVE SERVICE WITH ANY OTHER RECEIVER NOT HAVING THE SAME FREQUENCY MIXING SCHEME AS OUR FR-100-B OR FR-DX-400/500 RECEIVER.

In transceive service with the FR-100-B receiver, it is necessary to remove frequency shift circuit in the receiver for perfect transceive operation in USB and CW modes.

ALIGNMENT PROCEDURES

This Transmitter has been aligned and calibrated at the factory with proper test equipments and will not require realignment for a long period of operation. Service or replacement of a major components may require subsequent realignment but do not attempt to make any adjustment unless the operation of this transmitter is fully understood.

WARNING

Dangerous voltages are present, therefore extreme care is essential. Be sure that all power is disconnected before working in the chassis. Check the high voltages in the capacitors by shorting the high voltage line to the ground with an insulated screw driver.

(1) CHASSIS REMOVAL FROM THE CABINET

Remove the four screws on the bottom of the cabinet and six painted screws on the edge of the cabinet. From the rear, push the chassis forward and carefully slide the chassis and panel assembly out from the front of the cabinet.

(2) TEST EQUIPMENT REQUIRED

Recommended service equipment for alignment are:

- A. vacuum tube volt-ohm-meter with a RF probe.
- B. signal generator covering 455kHz to 35 MHz.
- C. calibrated communication receiver.
- D. oscilloscope.
- E. audio oscillator.

F. dummy load.

(3) VOLTAGE MEASUREMENTS

Set the operation switch to release position, and allow the transmitter to warm up. Check the voltages of the tube at the tube socket by VTVM. The nominal values are given on the chart. 600 volts DC is only used for the final plate supply and 300 volts for the other supplies. A regulated supply is set at 150 volts by a potentiometer which is located under the top cover and marked VOLT REG.

(4) 455KHz CARRIER OSCILLATOR AND BM CIRCUIT

Tune the transmitter up on 3.8MHz (80 meter band) in TUNE mode into dummy load. Switch to upper sideband (USB on MODE switch). Connect a VTVM RF probe to the center of the balance potentiometer. Adjust the slug of L₃ for maximum VTVM reading and turn half rotation to clock-wise direction. Disconnect the VTVM. Adjust the carrier null potentiometer and the trimmer capacitor located close to the mechanical filter assembly for minimum power output with the VTVM RF probe connected to antenna terminal. If VTVM is not available, a station receiver may be used for carrier balance indication. Release OPER switch. Connect VTVM RF probe to pin 5 of V₃ and an audio oscillator to the MIC jack and tune it to 1500 Hz, and adjust two pot cores in the mechanical filter assembly for maximum VTVM reading.

(5) SIDEBAND OSCILLATOR AND 9 MHz IF AMPLIFIER

To adjust sideband oscillator frequency, FR receiver should be connected in transceive operation. Set the receiver clarifier at center, and monitor the transmitted signal in USB mode. Adjust TC1 for natural listening to the audio quality. Set the MODE switch to LBS, both transmitter and receiver, and adjust TC6 for natural listening audio quality. Connect VTVM RF probe to pin 7 of 6AW8, in TUNE mode, adjust slugs on L1 and L2 for maximum VTVM reading.

(6) HETERODYNE MIXER AND OSCILLATOR

Set the band switch to 10D and operation switch to SPOT. Connect a signal generator to pin 7 of 6AW8A and a VTVM with the RF probe to pin 1 of V₇, 6CB6. Remove VFO injection by the transceive switch. Tune the signal generator to 35.0MHz exactly and adjust the plate coil of the 6AW8 tube marked 10D for maximum output reading on the VTVM. Repeat this procedure with the band switched to 10C, 10B, 10A, 15 20 and 40 meters. The signal generator settings are 34.4MHz for 10C, 34.0MHz for 10B, 33.4MHz for 10A, 26.4MHz for 15, 19.4MHz for 20 and 12.4MHz for 40 meter. Set the BAND switch to 15 meter band. Tune the signal generator to 17.4MHz, and adjust L₁₁ for minimum VTVM reading. Tune signal generator to 25MHz and adjust L₅ for minimum VTVM reading. Set the BAND switch to 20 meters. Tune the signal generator to 9MHz and adjust the slugs of the trap coils L₆ and L₉ for minimum VTVM reading. Readjust the 20 meter plate coil for maximum VTVM reading on 19.4 MHz, because of interaction between two coils, Repeat this procedure for 40 meter with the setting of signal generator at 6.8MHz for L₇ trap and 12.4MHz for the plate coil. Disconnect the signal generator and VTVM from the circuit and change TRANSCEIVE switch to VFO. Readjust all coils for maximum output except trap coils.

This is necessary to eliminate the errors due to VTVM's input capacitance and inaccurate setting of the signal generator. Connect VTVM to the output pin of L₄ (9MHz output transformer). Set the MODE switch to LSB. Set the BAND switch to 10D. Adjust the slug of heterodyne

oscillator coil L37 for 0.5 volt RMS VTVM reading. Set the BAND switch to 10C and adjust TC13 for maximum VTVM reading. Adjust TC12 at 10B, TC11 at 10A, TC10 at 15, and TC at 20 meters. Set the BAND switch to 40 meters and adjust L36 to read VTVM 0.5 volt.

(7) VFO MIXER AND DRIVER PLATE COILS

Connect a 50 or 75 ohm dummy load to the antenna terminal. Tune the transmitter up on 28.8MHz on CW mode. Set the GRID control to center. Adjust the slugs of L13 and L19 marked 10 for maximum output. Repeat this procedure for all bands. This procedure must be done quickly to protect the final PA tubes.

(8) VFO CALIBRATION

If the dial error increases, the VFO corrector coil and trimmer should be readjusted. Proceed as follows; Set the BAND switch to 80 meter band. Tune the station receiver exactly to 3.5MHz. Set the VFO dial to 3.5MHz and adjust a slug on the bottom of the VFO box for zero beat. Tune the receiver to 4.1MHz exactly and set VFO to 4.1MHz. Adjust the trimmer capacitor TC-3 for zero beat, adjust until 3.5 MHz and 4.1MHz are exactly on frequency.

IMPORTANT: Do not use any oil on the VFO gear. Do not touch a red marked screw. This screw is the adjustable temperature compensator. (TC-7).

The temperature compensator is adjusted in following manner. Check the frequency drift at first. When VFO frequency drifts to higher direction, in another word, transmitting frequency drift toward lower direction turn red marked screw counterclockwise few turns. By this, total tuning capacity decreases, therefore adjust TC3 to compensate this decrease.

(9) BIAS SETTING FOR FINAL TUBES

Tune the transmitter to SSB mode, set the VOX GAIN control to OFF and push the OPER switch down. Adjust the bias control potentiometer under the top cover to a point which IC (total cathode current) shows 50 milliampere.

(10) FINAL AMPLIFIER NEUTRALIZATION

The final amplifier may be neutralized as follows. Tune the transmitter up on 21.3MHz (15 meter band) in CW MODE. Carefully tune the plate and observe the plate current dip and relative power output peak. If both occur at the same setting, the amplifier is neutralized. If not, adjust the neutralizing capacitor, in small increments (1/4-1/2 turn) with an insulated screw driver from the opening on rear apron of the chassis until neutralization is accomplished.

(11) VFO TRAP COIL (L42) ALIGNMENT

Set the BAND switch to 40 meters, and tune the VFO dial to scale 0 (5.4MHz). Connect a VTVM with the RF probe to pin 5 of one of V13, V14, 6JS6C's.

Set the MODE switch to LSB position, and turn the MIC GAIN control to fully counterclockwise. Press the OPER switch to as to obtain TRANSMITTING condition, and adjust the slug of the trap coil L42 for minimum VTVM reading.

TROUBLE SHOOTING

Most cases of trouble can be traced to defective tubes. Substitution of new tubes will sometimes clear an obscure case. Intermittent fault in tubes can be discovered by lightly tapping the tube. Occasionally, tube socket terminals will become dirty or corroded causing an intermittent condition.

Tables show typical voltage and resistance readings at each tube socket terminal except those of the VFO tube. These are the best aid in trouble shooting. Make all measurements under the conditions noted on the charts. The values listed are nominal, and vary slightly due to line voltage

fluctuation and to normal tolerances in components.

Following are typical cases of the trouble and a trouble shooting guide.

PA idling current unstable:	Defective PA tubes. Defective bias potentiometer. Defective bias supply. Defective voltage regulator circuit.
Inability to full load:	Grid improperly tuned. Antenna not resonant at frequency. Defective transmission line. Defective PA and driver tubes.
Insufficient carrier or sideband suppression:	Carrier balance control improperly adjusted carrier oscillator frequency incorrect. Defective balance modulator diodes. Mic gain setting too high.
Distorted signal:	Defective ALC circuit. Defective mechanical filter. 6BM8 regulator circuit defective. Mic gain setting too high. Improper neutralization.
Unstable VOX operation:	V10, 6U8 defective. Improper setting of VOX controls.
Frequency unstable:	Defective voltage regulator tube, 6BM8 or neon tube NL-6S.

ACCESSORY SOCKET

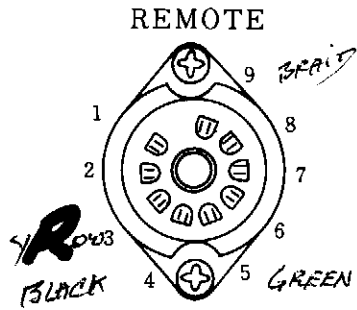

POWER OUT SOCKET

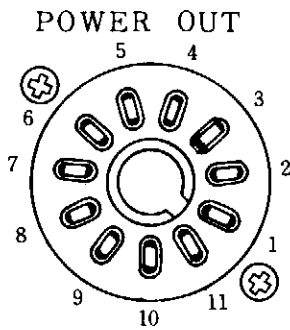

COIL ALLOCATIONS

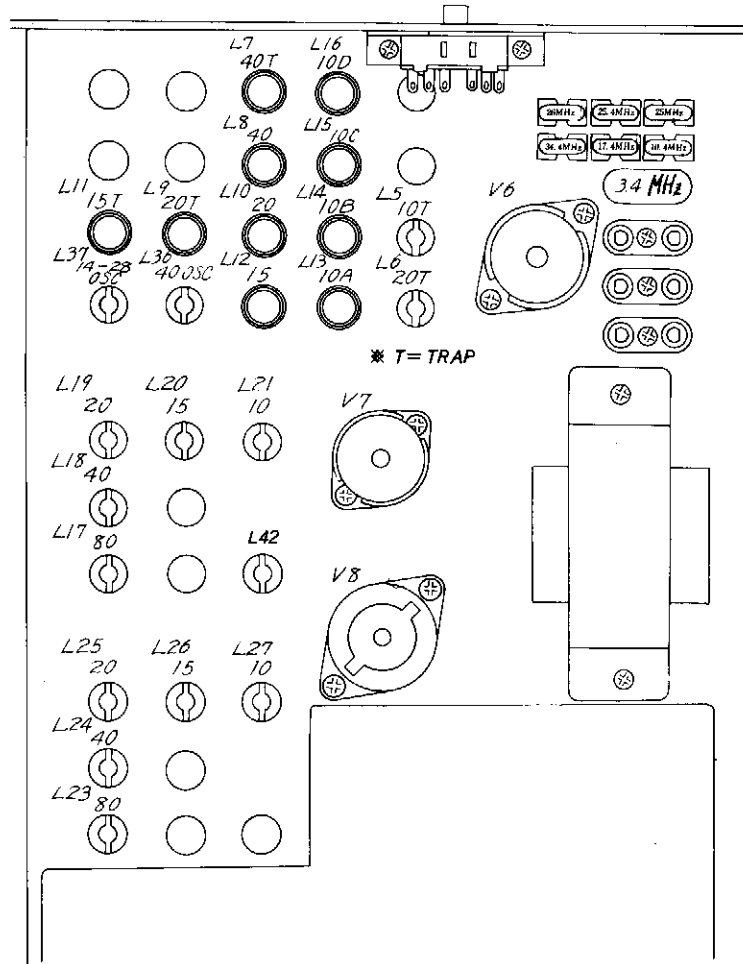

KEY AND MICROPHONE CONNECTIONS

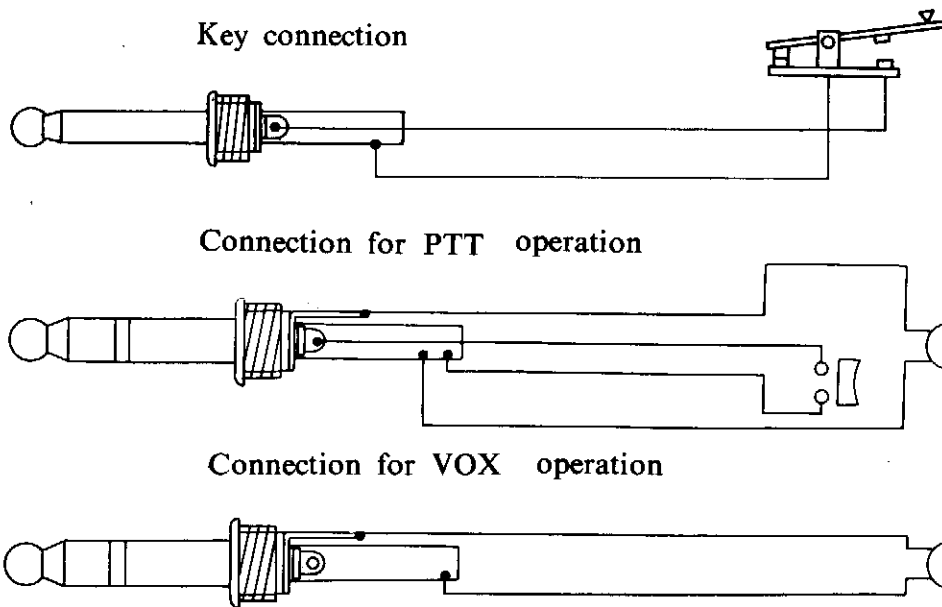

Ground lead for microphone should be wired separately and connected together to the ground lead of PTT switch at plug terminal.

STATION INTERCONNECTIONS

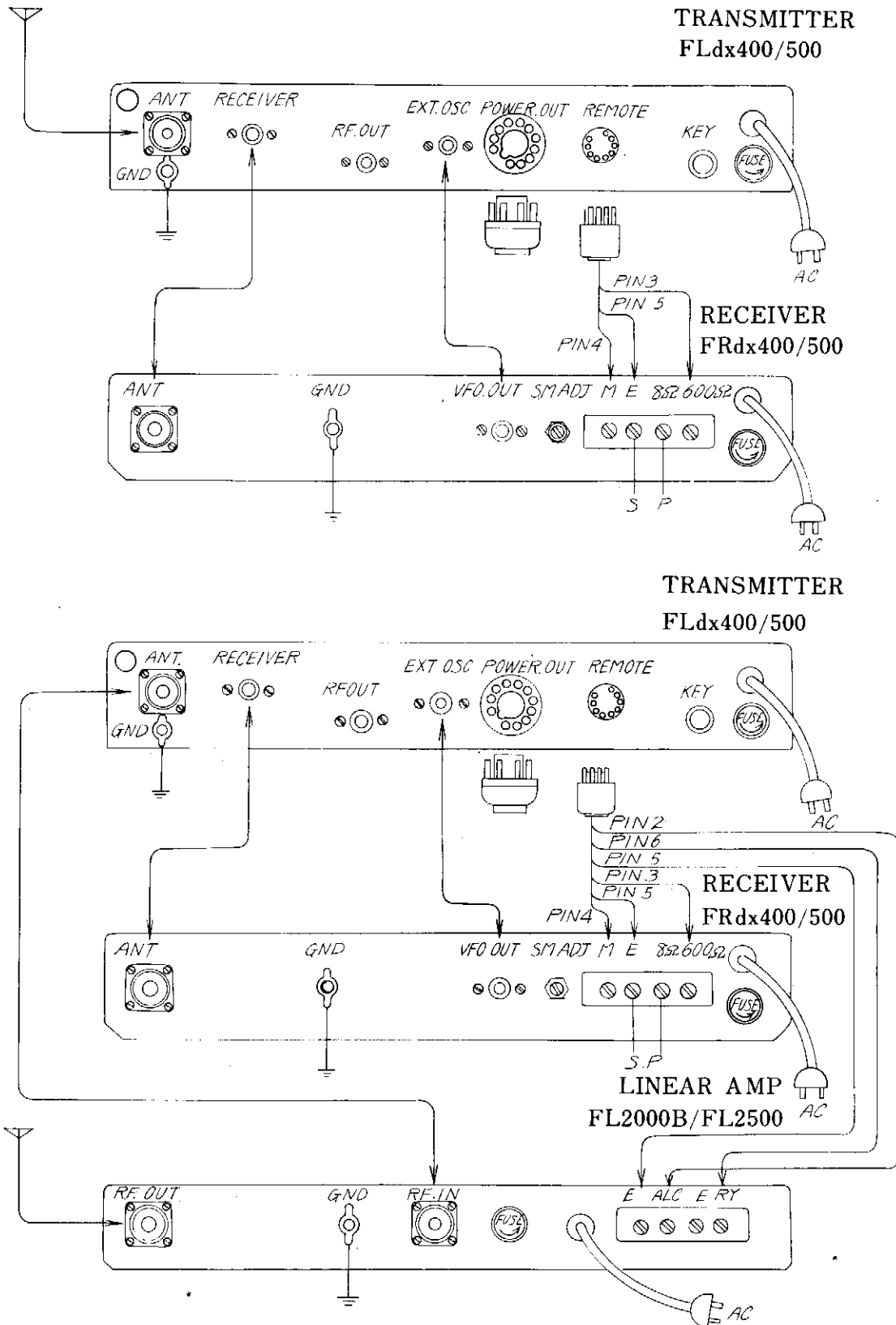

VOLTAGE - CHART

TUBE	PIN NUMBER												
	1	2	3	4	5	6	7	8	9	10	11	12	P
V1 6AN8	190V	0	3.8V	6.3V *	0	40V	0.6V	2.4V	0				
V2 12AT7	145V	0	3.2V	0	0	145V	0	3.2V	6.3V *				
V3 6BA6	0	3.5V	6.3V *	0	270V		130V	3.6V					
V4 12AU7	120V	-70V	2.4V	0	0	120V	-70V	2.4V	6.3V *				
V5 6U8	125V	4.5V	50V	6.3V *	0	120V	0	1.5V	0V				
V6 6AW8	0	-2V	140V	6.3V *	0	0-2.6V	-10V-0	195V	310V				
V7 6CB6	-14V/0	0/1.8V	6.3V *	0	310V		140V	0/1.8V					
V8 12BY7	0/4V	-14V/0	0	6.3V *	6.3V *	0	310V	280V	0				
V9 6BM8	45V	140V	120V	6.3V	0	310V	310V	50V	120V				
V10 6U8	0-170V	0	25V	6.3V *	0	25V	0.8V	2.4V	-0.4V				
V12 VR150	150V	0	0	0	150	0	0						
V13 V14 6JS6A	6.3V *	0	150V	0	-55V/ -45V		0	0	-55/ 45V	0	150V	0	

*印 AC VOLTAGE

RESISTANCE - CHART

TUBE	PIN NUMBER												
	1	2	3	4	5	6	7	8	9	10	11	12	P
V1 6AN8	50K	47K	500K	0	0	500	1K	220Ω	0-500				
V2 12AT7	30K	10K	1K	0	0	30K	100K	1K	0				
V3 6BA6	70K	330Ω	0	0	35K	40K	330						
V4 12AU7	50K	270K	470Ω	0	0	50K	270K	470Ω	0				
V5 6U8	60K	470K	280K	0	0	40K	0	1K	0-500K				
V6 6AW8	0	47K	40K	0	0	330Ω	50K	60K	30K				
V7 6CB6	60K	330Ω	0	0	30K	60K	330Ω						
V8 12BY7	100Ω	50K	0	0	0	0	30K	30K	0				
V9 6BM8	15K	50K	1M	0	0	30K	30K	∞	1M				
V10 6U8	60K	0-500K	1M *	0	0	500K	1K	150Ω	1M-3M				
V12 VR150	35K	0	8	0	35K								
V13 V14 6JS6A	0	0	50K	0	25K	25K	0	∞	25K	0	50K	0	

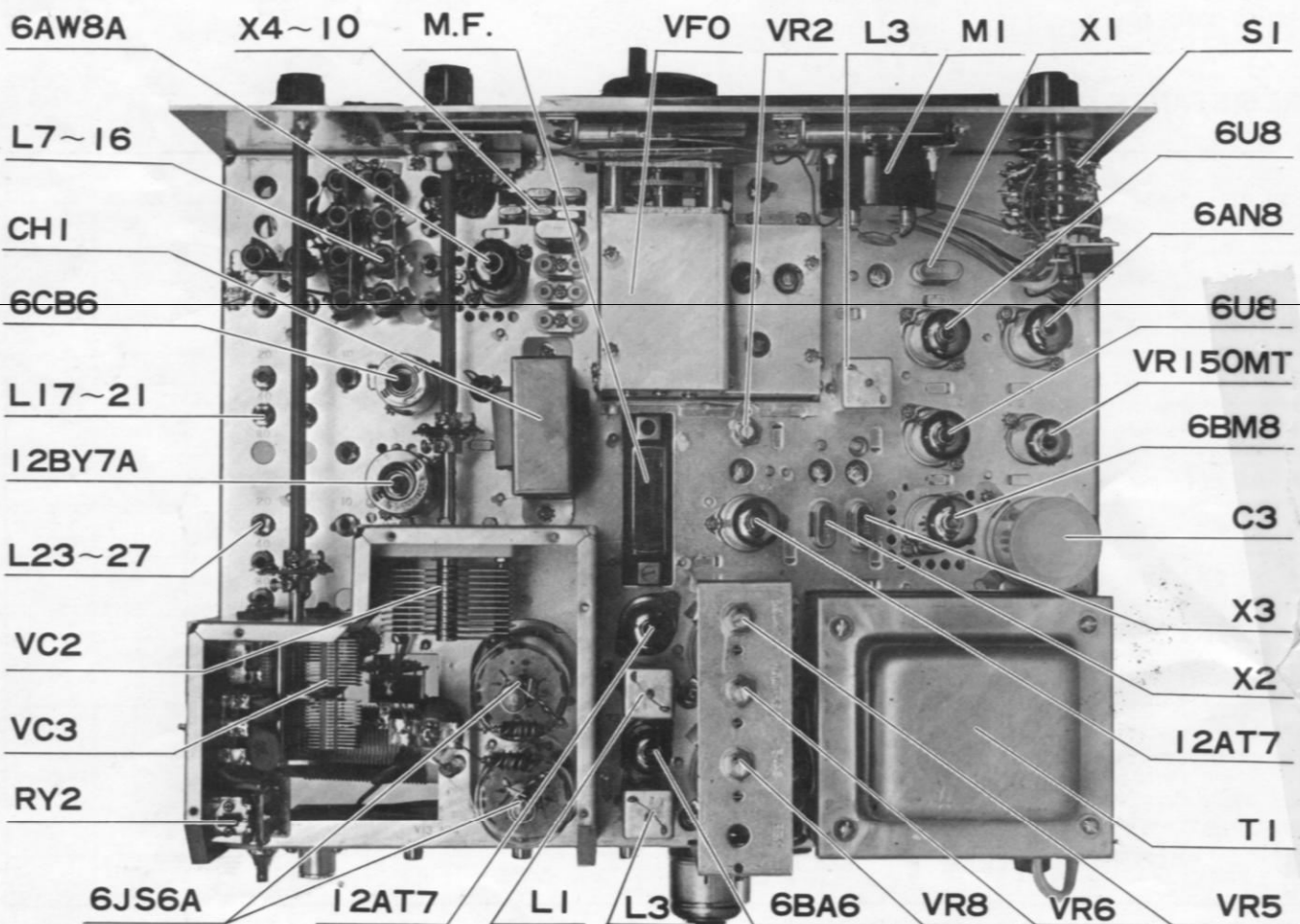
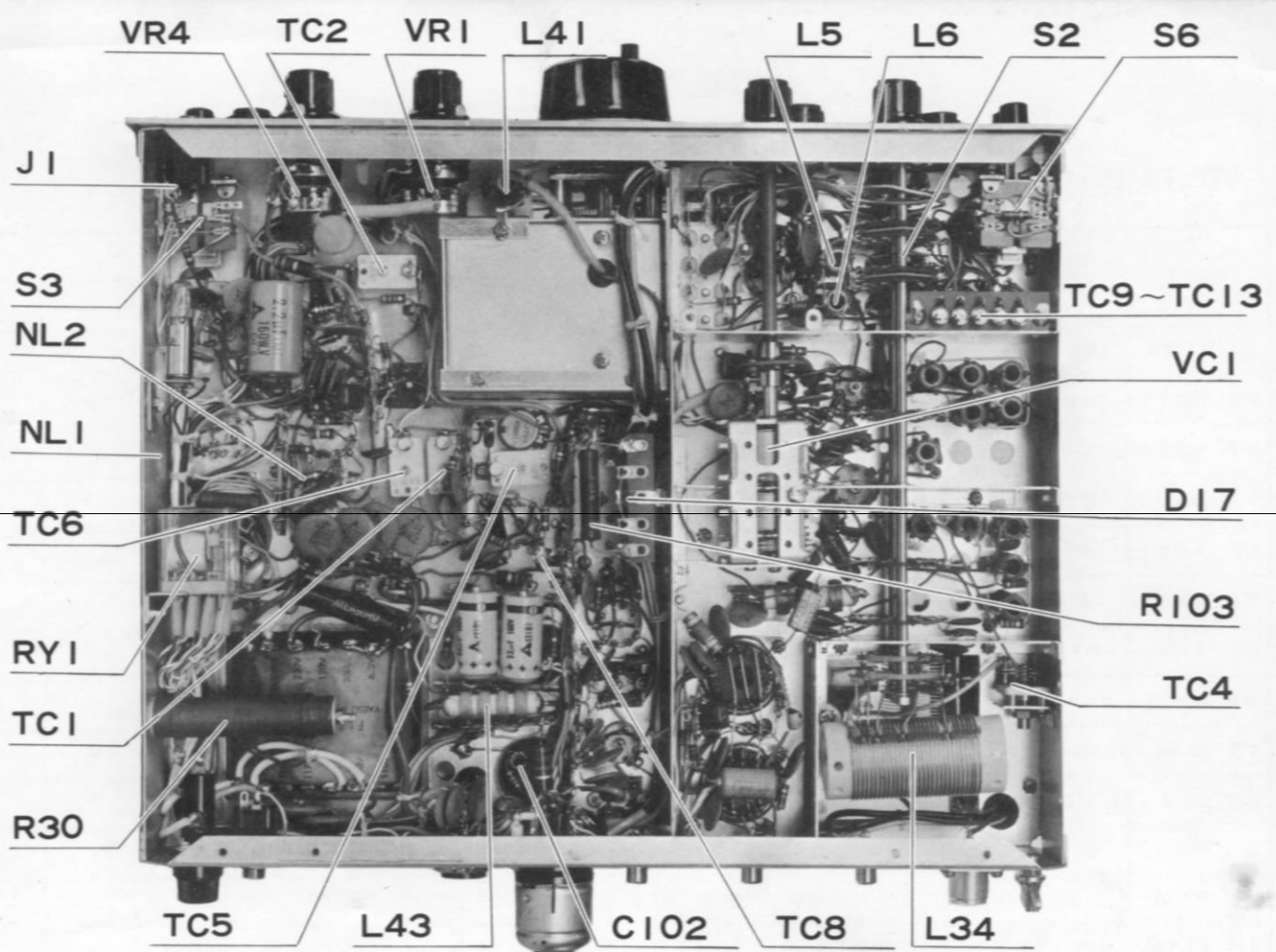

PARTS RIST

V-(TUBE)		404	CERAMIC	500W V NPO	10P	±0.5 P
1	6 AN 8	413	"	500W V UJ	10P	±0.5 P
2	12AT 7	414	"	"	5 P	"
3	6 BA 6	416	"	"	7 P	"
4	12AU 7	R-(VFO-BOX RESISTOR)				
5, 10	6 U 8	401, 403		¼W or ½W		100K ±10%
6	6 AW 8 A	402, 405		"		330Ω "
7	6 CB 6	404, 406		"		1 KΩ "
8	12BY 7 A	407		"		8.2KΩ "
9	6 BM 8	408		"		22KΩ "
12	VR 1 5 0 MT	409		"		270Ω "
13, 14	6 JS 6 A	410		"		220Ω "
TR-(TRANSISTOR & FET)		FSK(OPTION) C, R				
		R-105		½W	10K	±10%
		106		½W	33K	±10%
401, 402 (VFO)	3 SK 2 2 G	C-157	CERAMIC (DISC)	500W V	0.01μ	+100% -0
403 (")	2 SC 3 7 2 Y	158	FM-MICA	500W V	100P	±10%
VS-(TUBE SOCKET)		159	"	500W V	5 P	±10%
1, 2, 4-6, 9, 10	9 P	R-(RESISTOR)				
3, 12	7 P	1, 14, 17, 20, 34		½W	47K	±10%
7	7 P (SHEILD)	40, 49, 54, 57, 104				
8	9 P (")	2, 10, 12, 24, 32		½W	1 KΩ	±10%
13, 14	12P	44, 45, 53, 55, 73				
J-(JACK)		90, 91, 98				
1 (MIC)	SG-7701	3, 25, 29, 36		½W	1 MΩ	±10%
2 (KEY)	SG-7615	39, 95				
3, 5, 8 (EXT. OSC)(REC)(RF, OUT)	RCA-JACK	4, 21, 22, 85, 99		½W	270KΩ	±10%
4 (ANT)	JSO-239(INCH)	6		½W	220Ω	±10%
6 (REMOTE)	9 P	9, 67, 80		½W	10KΩ	±10%
7 (POWER OUT)	SA-602B(11P)	8, 79		½W	22KΩ	±10%
P-(PLUG)		7, 27, 42, 43, 51		½W	100KΩ	±10%
1	3 P	52, 102				
2	2 P	13, 41, 50		½W	330Ω	±10%
3, 5, 8	RCA PLUG	15, 61, 77, 94		½W	4.7KΩ	±10%
4	M-P-7 (INCH)	23, 60		½W	220KΩ	±10%
6	S-I 8 5 0 1 (9P)	26		½W	390KΩ	±10%
7	PA-602B (11P)	28, 63		½W	100Ω	±10%
L-(INDUCTOR)		35, 46, 47		½W	150Ω	±10%
1	0.2φ UEW 10T×2 i 0.2φ UEW18T	37		½W	5.6KΩ	±10%
2	0.2φ " " i 0.2φ UEW21T	48, 93, 100, 101		½W	2.2KΩ	±10%
3	USSC0.16(H) 170T i 40T(H)	56, 69, 84, 86, 18		½W	56Ω	±10%
4, 22, 29, 38	½W 56Ω 0.6φ (S) 4 T	19,		½W	470Ω	±10%
5, 26, 27	0.6φ UEW(S) 8 T	75		½W	3.3KΩ	±10%
6, 41	0.5φ UEW 20T	78, 82, 83, 7		½W	470KΩ	±10%
7, 9	0.06/4 USTC 30T	96		½W	1.5KΩ	±10%
8, 10	0.6φ UEW(S) 8 T (CT)	5		2 W	15KΩ	±10%
11, 18, 24	0.32 UEW 25T	3, 66, 81		1 W	4.7KΩ	±10%
12, 20	0.6φ UEW 5.5T	38		1 W	22KΩ	±10%
13, 14, 15, 16, 21	0.6φ UEW(S) 5 T	70, 71		1 W	56Ω	±10%
17, 23, 36	0.2φ UEW 30T	64, 31		3 W	47KΩ	±10%
19, 25, 37	0.5φ UEW 11T	65		2 W	4.7KΩ	±10%
31, 32	1W 56Ω 1φ (S) 4 T	30		20W	5 K	±10%
28 (RFC)	0.23φ USTC 80T×3 (200μH)(H)	103		7 W	8.2K	±5%
30 (RFC)	0.23φ USTC 55T×3 (100μH)(H)	97		3 W	15K	±10%
33 (PLATE RFC)	12φ ×75 0.29φ USTC ×6 (H)	88		4 W	5.6Ω	±10%
34 (LOADING)	30φ ×70 1.2φ 30T	68		METER SHUNT		
42 (TRAP)	0.2φ UEW 25T	C-(CAPACITOR)				
43 (FILTER CH)	0.06/4 80T×4 (H)	(ELECTROLYTIC) -C				
401 (VFO OSC)	15φ ×32 0.4φ DSC 30T	1, 29, 33			16W V	10μ
402, 403	250μ H	3			350W V	40μ ×2, 20μ
(COUPLING)		99, 100			150W V	30μ
S-X 3501	3	154			250W V	5 μ
SC-2 (VFO)	1	102, 103			350W V	100μ
C-(VFO BOX CAPACITOR)		(MP)-C				
401, 402	FM MIGA 500WV 650P ±10%	2, 32			250W V	0.05μ
408	" " " 100P "	6			150W V	2 μ
415	" " " 50P "	(MYLAR)-C				
403, 405	CERAMIC DISC 500WV 0.01 +100% -0	36, 97			50W V	0.1μ
406, 407, 409	" " " " " "	(OIL)-C				
410, 411, 412	" " " 50WV 0.01 +100% -0	81			600W V	0.047μ

(MICA)-C				VR-(POTENTIOMETER)		
75	1 KWV	50P	±10%	1 (CARRIER) (MIC GAIN)	2 KB	500K A
84	3 KWV	1000P		2 (BALANCE)	200Ω B	
(FM-MICA)-C				3 (ALC ADJ)	5 KB	
5, 9, 48, 144, 78	500W V	250P	±10%	4 (DELAY)(VOX GAIN)	3 MB,	500K A
8, 14, 15, 16, 31, 12	500W V	100P	±10%	5 (RELAY)	3 KB	
54, 66, 98, 148, 151				6 (VOLT REG)	50K B	
156				7 (ANTITRIP)	500K A	
11, 76	500W V	400P	±10%	8 (BIAS)	20K B	
18, 41	500W V	470P	±10%	9 (FSK) OPTION	500K A	
145	500W V	500P	±10%	T-(TRANS FORMER)		
17, 49, 63, 64, 73	500W V	70P	±10%	1	POWER TRANS	
19, 20, 26, 27, 40	500W V	50P	±10%	CH-(CHOKE TRANS)		
47, 50, 51, 53, 62				1	2.5 H	150m A
72				RY-(RELAY)		
28, 74, 150	500W V	30P	±10%	1 (VOX)	SRE 5D11	DC100 V
38	500W V	3P	±10%	2 (ANT)	AR-42	DC100V
42	500W V	2P	±10%	M-(METER)		
52, 152, 153, 143	500W V	20P	±10%	1	MRA-45	
55, 61, 71, 85	500W V	150P	±10%	NL-(NEON LAMP)		
65	500W V	40P	±10%	1	NL-6S	
79	500W V	180P	±10%	2	NE-68	
86, 124	500W V	10P	±10%	PL-(PILOT LAMP)		
106	500W V	1000P	±10%	1, 2	6.3V ~ 8V (SWAN)	
132, 140	500W V	5P	±10%	PLH-(PILOT LAMP HOLDER)		
133	500W V	300P	±10%	1, 2	NO-3512	
139, 146	500W V	200P	±10%	NLH-(NEON LAMP HOLDER)		
142	500W V	120P	±10%	1	S-E3004 (SWAN)	
(CERAMIC) DISC TYPE				F-(FUSE)		
4, 7, 10, 13, 21	500W V	0.01μ	+100% -0	1	100V ~ 117V (5 A) 200V ~ 234V(3A)	
22, 23, 25, 30				FH-(FUSE HOLDER)		
34, 35, 43, 44, 45				1	S-N1001	
46, 57, 58, 59, 60				(PLATE CAP)		
67, 68, 69, 70, 77				1, 2	FOR 6JS6A	
80, 82, 96, 101, 107				X-(CRYSTAL)		
108, 109, 110, 111, 112				1 (CARRIER)	HC/6U	453.5 kHz *
113, 114, 115, 116, 117				2 (USB)	"	8543.5 kHz *
118, 119, 121, 122, 125				3 (LSB)	"	9453.5 kHz *
126, 128, 129, 130, 131				4 (40)	"	3.4 MHz *
134, 141, 147, 149, 155				5 (20)	HC/25U	10.4 " "
104, 105, 127	A L 150V A C		+100%	6 (15)	"	17.4 " "
	1.4K V D C	0.01μ	-0	7 (10A)	"	24.4 " "
135, 136, 137, 138	A L 150V A C		+100%	8 (10B)	"	25.0 " "
	1.4K V D C	4700P	-0	9 (10C)	"	25.4 " "
				10 (10D)	"	26.0 " "
TC-(TRIMMER CAPACITOR)				(RUBBER GROMMET)		
1, 6, 2	#412	50P MAX		NG-79-A		2
5	#412	100P MAX		" E		2
8	1ZW32	10P MAX		" G		3
9-13	1ZW32	20P MAX		KG-146		1
401 (VFO)	TSN150C	30P MAX		(KNOB)		
402 (")	TSN150C	10P MAX		(VOX)(MIC)(GRID)(PLATE)(LOADING)	FT-25
4 (NEUT)	TSN170C	10P MAX		(BAND)(MODE)	FT-25T
				(MAIN DIAL)	FOR25kHz
VC-(VARIABLE COPACITOR)				(TERMINAL)		
1 (GRID)	340P × 2	18P × 2		1 L 4 P		11
2 (PLATE)	300P			1 L 2 P		3
3 (LOADING)	430P × 2			1 L 1 P		1
401 (VFO)	50P (MAX)			1 L 4 P (S)		3
				1 P		3
(PRINTED BOARD)				(MECHANICAL FILTER)		
1 (MF1)	PB-1027			MF-1	MF455	10A Z 28
2 (VFO)	PB-1056			D-(DIODE)		
3 (TRIMMER)	PB-1025			1 ~ 4, 7	1 S 1007	
				5, 6, 12 ~ 16	SH-1	
				8 ~ 11	SD-1 C	
				17	1 S 334	
				18 (FSK) OPTION	1 S 568	
S-(SWITCH)				(DIODE)		
1, 8 (MODE) (POWER SW)		4-7-7 (SW × 1)				
2 (BAND)		8-10-11				
3, 6 (OPER) (SPOT)		1S(L)22				
4 (CHECK)		1S(A)22				
5, 7 (TRANSCIVE) (METER)		SSH-23				

V1 6AN8(a)

V1 6AN8(B)

V2 12AT7

V3

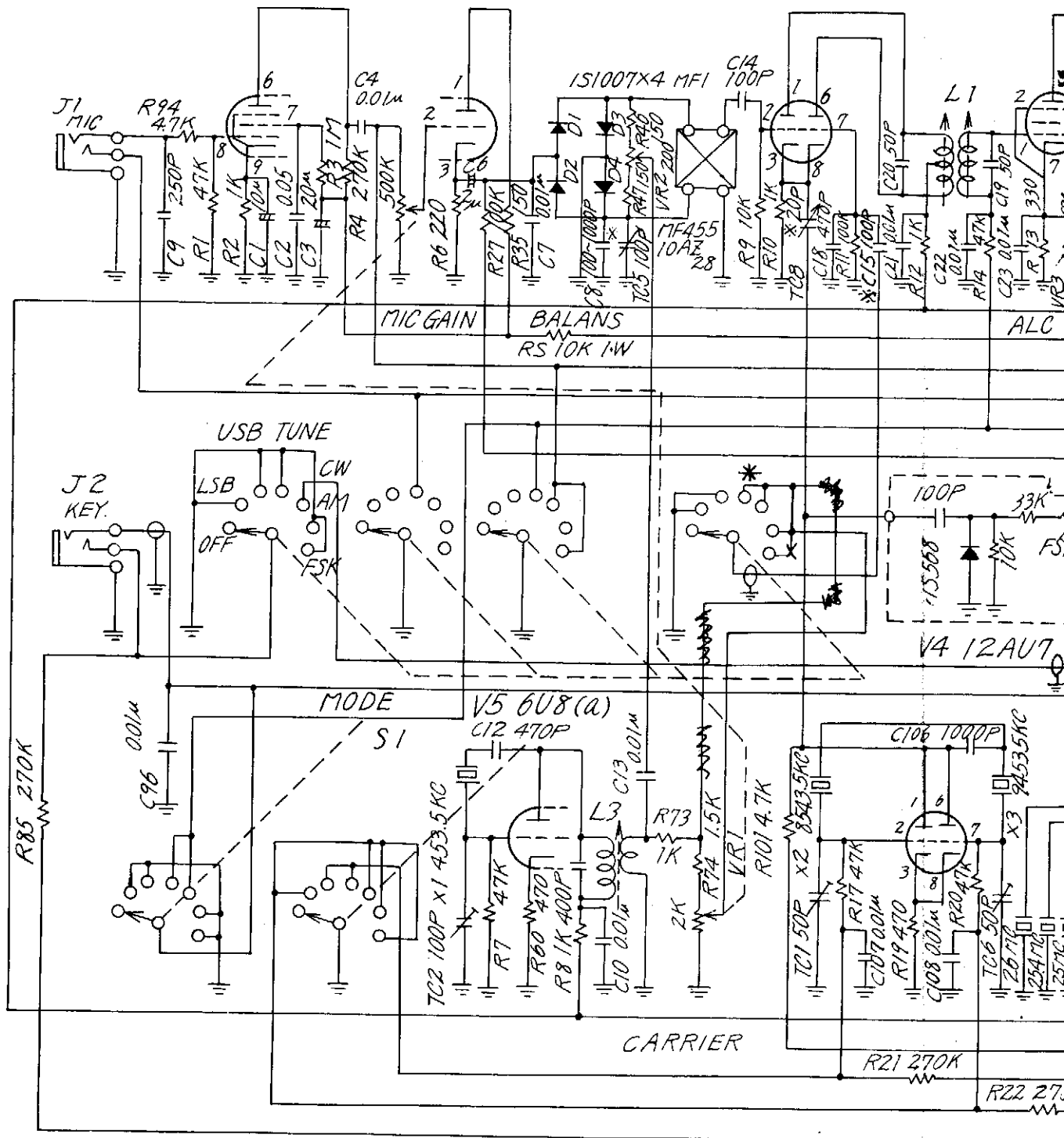

M. G. FARMER

20

PLYMPTON 3038

* Mode Switch wired to permit carrier injection control on TUNE, CW, & AM.

V3 6BA6

V6 6AW8A(a)

BAND

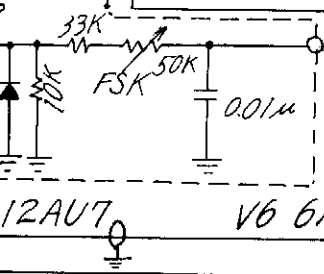
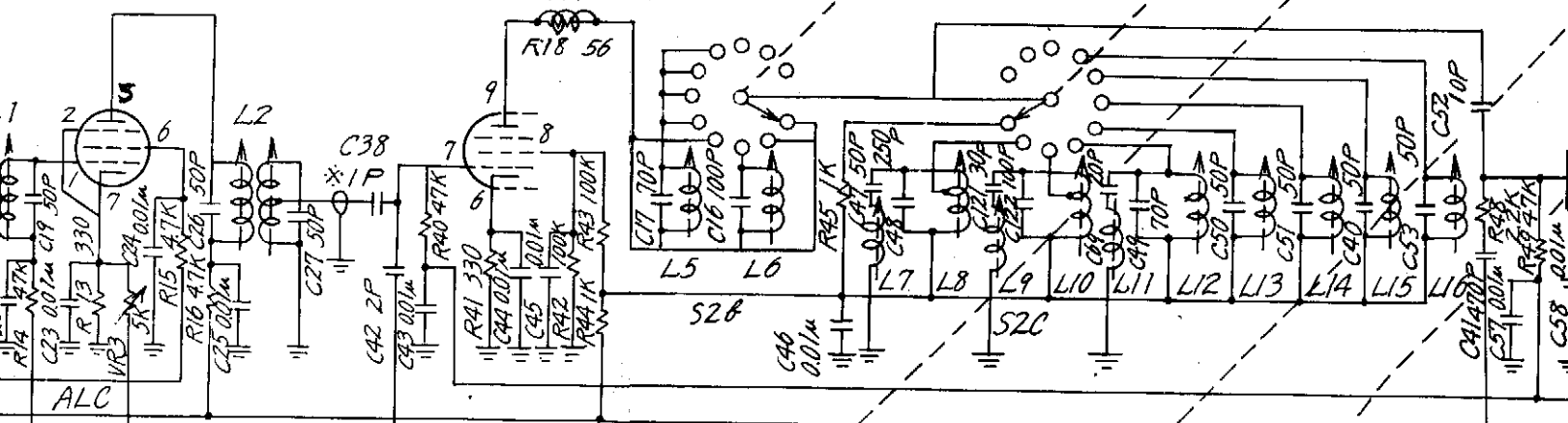

V6 6AW8A(b)

VII 12AU7

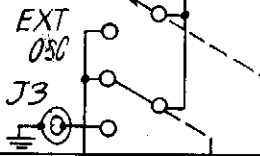

TRANSCEIVER

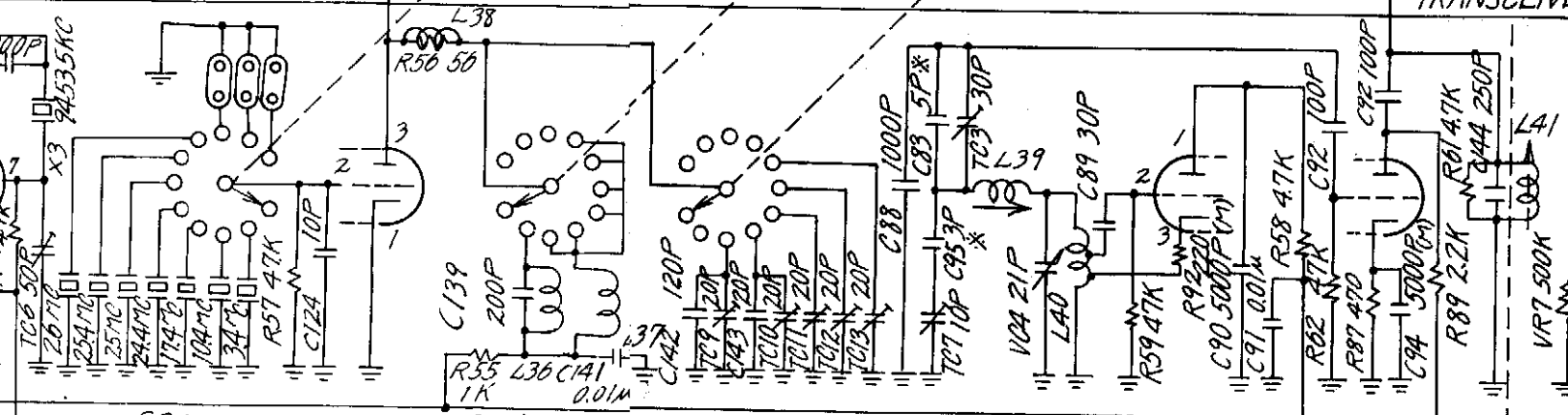

S2a

S2d

S2e

AN

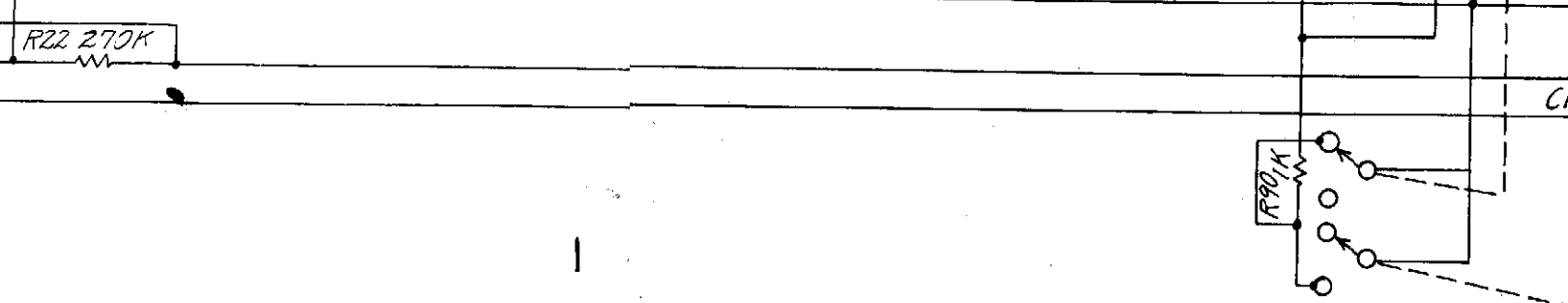

C

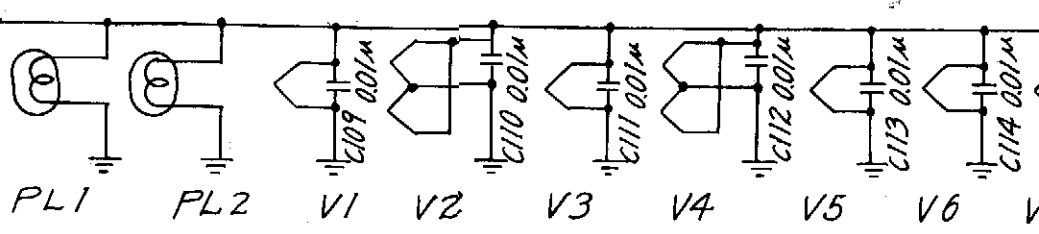
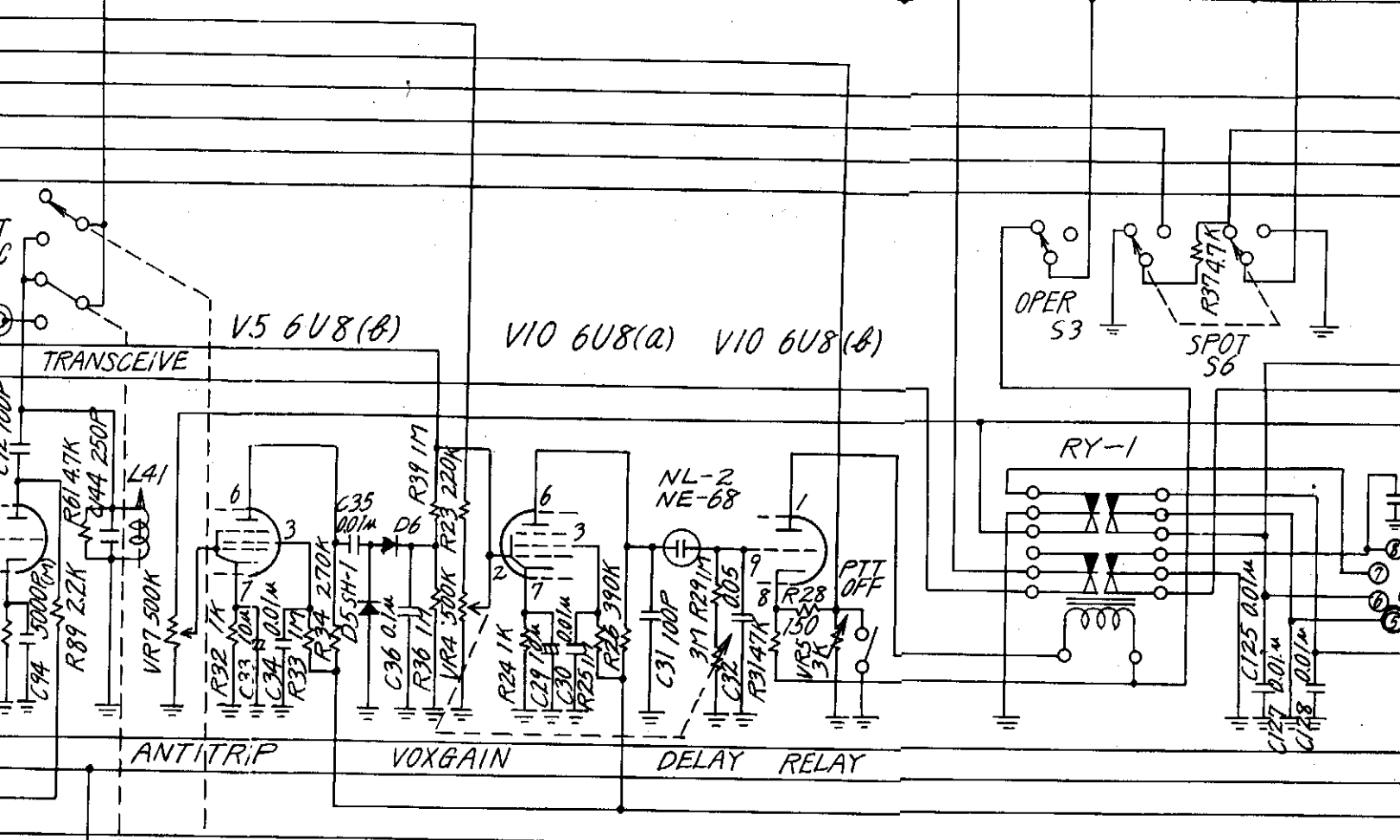
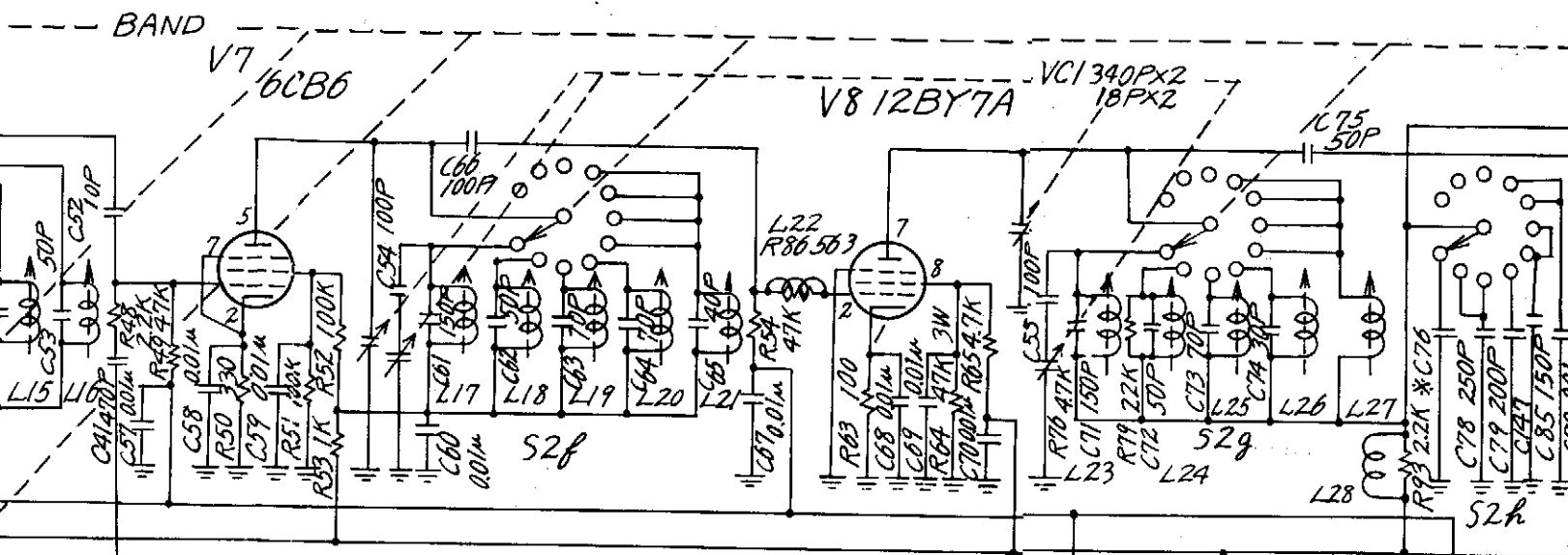

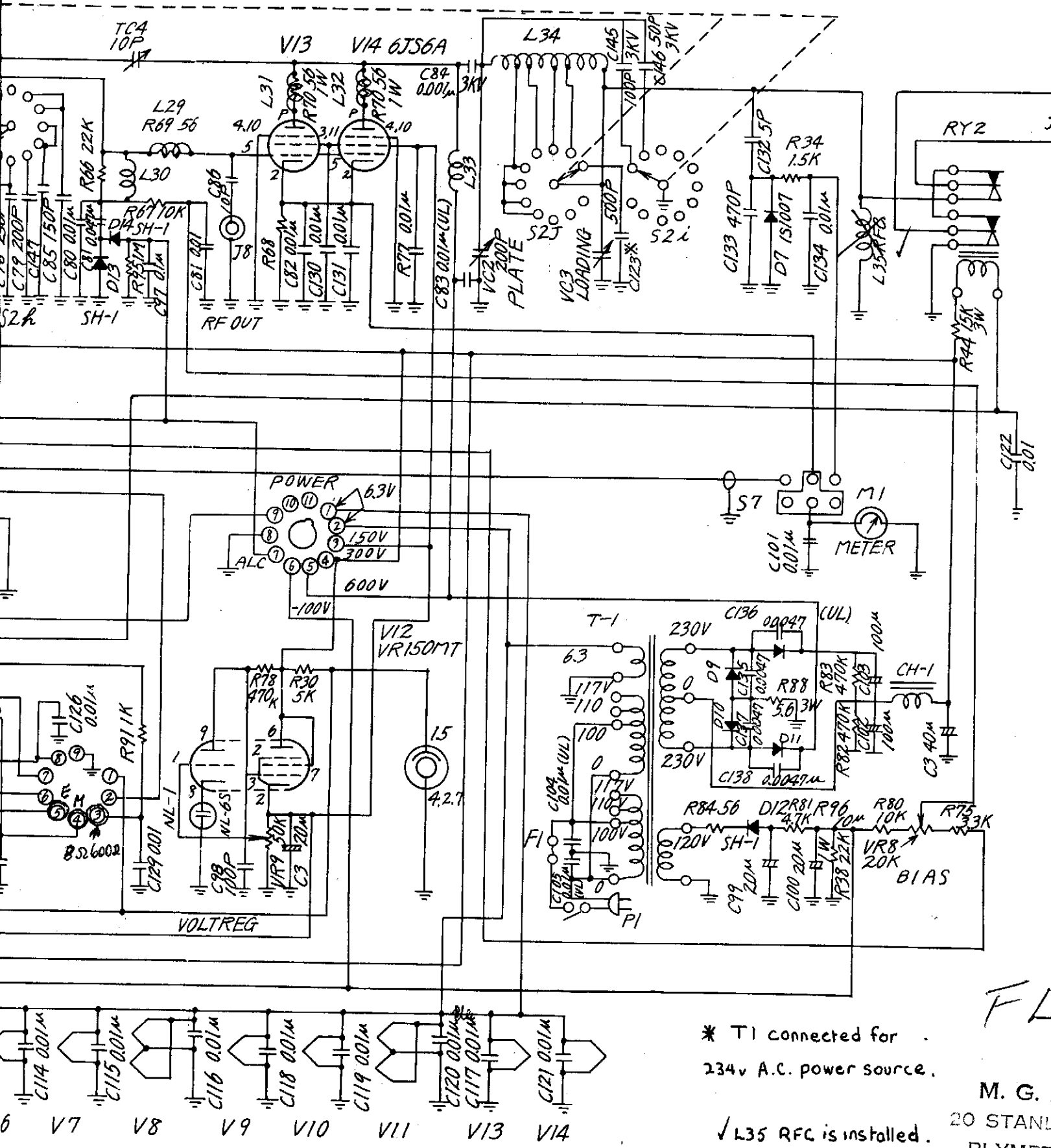

* T1 connected for
234v A.C. power source.

√ L35 RFC is installed.

FL

M. G.
20 STAND
PLYMPT

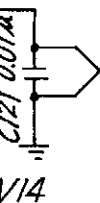
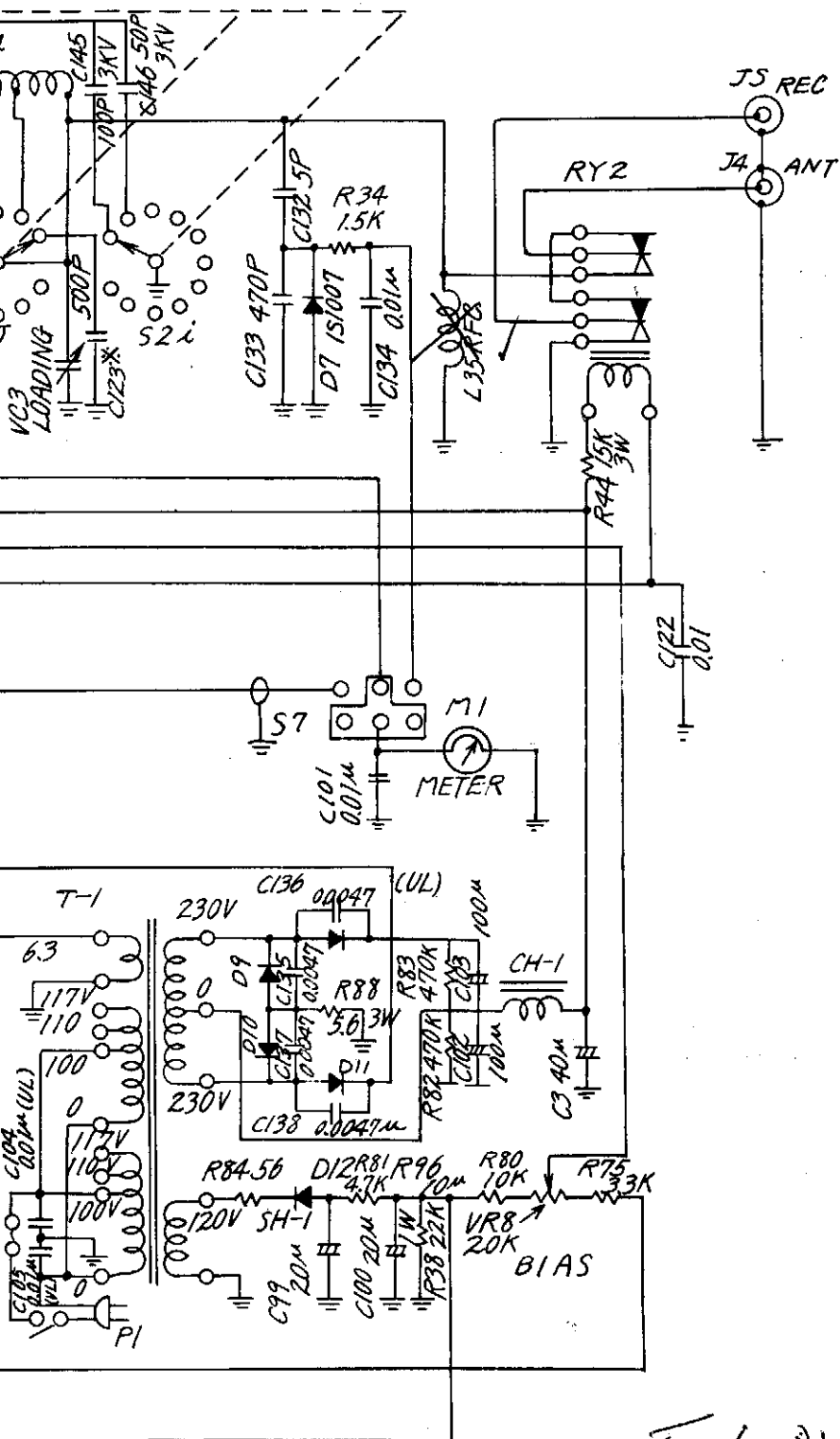

* T1 connected for .
234v A.C. power source.

✓ L35 RFC is installed.

FLIX
A00

M. G. FARMER
20 STANLEY STREET,
PLYMPTON 5030

6/74



M. Park
255 3294

K4XL's **BAMA**

This manual is provided **FREE OF CHARGE** from the "BoatAnchor Manual Archive" as a service to the Boatanchor community.

It was uploaded by someone who wanted to help you repair and maintain your equipment.

If you paid anyone other than BAMA for this manual, you paid someone who is making a profit from the free labor of others without asking their permission.

You may pass on copies of this manual to anyone who needs it. But do it without charge.

Thousands of files are available without charge from BAMA. Visit us at <http://bama.sbc.edu>