



PCC-2000

REFERENCE BOOK

The PCC-2000 allows you to quickly and easily operate the Yaesu FT-2000/D HF/50 MHz Transceiver from your personal computer.

IMPORTANT NOTE

By using this software, you acknowledge that the Software is not intended for use in connection with any high risk of personal injury or strict liability activity (including, without limitation to, air travel, space travel, fire fighting, police operations, power plant operation, military operations, rescue operations, hospital and medical operations) and that Vertex Standard makes no warranty and shall have no liability in connection with any use of the Software in such situations.

All title and copyrights in and to the Software (including but not limited to any data, images, text, and other components), and the accompanying printed materials, are owned by Vertex Standard. The Software is protected by copyright laws and international treaty provisions, including U.S. federal criminal law. Vertex Standard and YAESU are trademarks of Vertex Standard.

Vertex Standard expressly disclaims any warranty for the Software and Services. The Software and Services and any related documentation are provided "AS IS" without warranty of any kind, either express or implied, including, without limitation, the implied warranties or merchantability, fitness for a particular purpose, security, or noninfringement. The entire risk arising out of use or performance of the Software and the Services remains with you.

VERTEX STANDARD CO., LTD.

PCC-2000 REFERENCE BOOK

TABLE OF CONTENTS

PCC-2000 System Components	3	Keyer Operation	16
FT-2000 and Computer Interconnections	3	Contest Memory Keyer	17
“PCC-2000” Personal Computer Controller Window ...	3	Rotator Control	17
Opening/Closing the PCC-2000 Controller Program ...	4	QMB Memory	17
Data Connection	4	Operation of Miscellaneous Knobs and Buttons	18
Switching Power On/Off of the FT-2000	4	[METER] Knob	18
AF Gain Control	4	[MIC] Knob	18
SQL Level Control	4	[RF PWR] Knob	18
Frequency Navigation on the Main Band (VFO-A)	5	[DIM] Button	18
Frequency Navigation on the Sub Band (VFO-B)	6	[MOX] Button	18
MODE Switch	7	[SPOT] Button	18
Clarifier Operation	7	[A] Button	18
Audio Playback Feature	7	[B] Button	18
Voice Memory Feature	8	[SPLIT] Button	19
Antenna Selection	8	[TXW] Button	19
IPO (Intercept Point Optimization)	8	Main [RX] Button	19
ATT (Attenuator)	8	Main [TX] Button	19
RF Gain Control	9	Sub [RX] Button	19
VRF (Variable RF Front-end Filter) Operation	9	Sub [TX] Button	19
Roofing Filter Selection	9	[FAST] Button	20
CONTOUR Filter /		[A▶B] Button	20
APF (Audio Peak Filter) Operation	9	[A▶B] Button	20
IF SHIFT Operation	10	[V/M] Button	20
WIDTH Operation	10	[M▶A] Button	20
NOTCH Operation	10	[A▶M] Button	20
AUTO NOTCH Operation	10	Main (VFO-A) [BAND] Button	20
Noise Reduction Operation	10	Main (VFO-A) [MHz] Button	20
NAR (One-Touch Narrow IF Filter Selection)	11	[GRP] Button	20
Noise Blanker Operation	11	[MCH] Button	20
AGC	12	Sub (VFO-B) [BAND] Button	21
LOCK Feature	12	Sub (VFO-B) [MHz] Button	21
VOX Operation	12	[FAST] Button	21
Using the Speech Processor	13	[A/B] Button	21
Using the Monitor	13	[DISPLAY] Button	21
Antenna Tuner Operation	13	Menu Operation	22
Repeater Operation	14	Command Send	23
Parametric Microphone Equalizer Adjustment	15	Function Key Operation	24

PCC-2000 REFERENCE BOOK

PCC-2000 SYSTEM COMPONENTS

- ❑ IBM® PC / compatible Computer with Microsoft® Windows® 2000, XP, or Vista
- ❑ 30 MB of available Hard Disk space
- ❑ 256 MB or more RAM
- ❑ RS-232C port
- ❑ 1024 x 768 color display with 256-bit color support on the video card
- ❑ RS-232C “Straight” Cable, DB9-pin Female to DB9-pin Female (Or, USB to RS-232C Adapter Cable*).

※: Some USB to RS-232C Adapter Cable does not function normally.

FT-2000 AND COMPUTER INTERCONNECTIONS

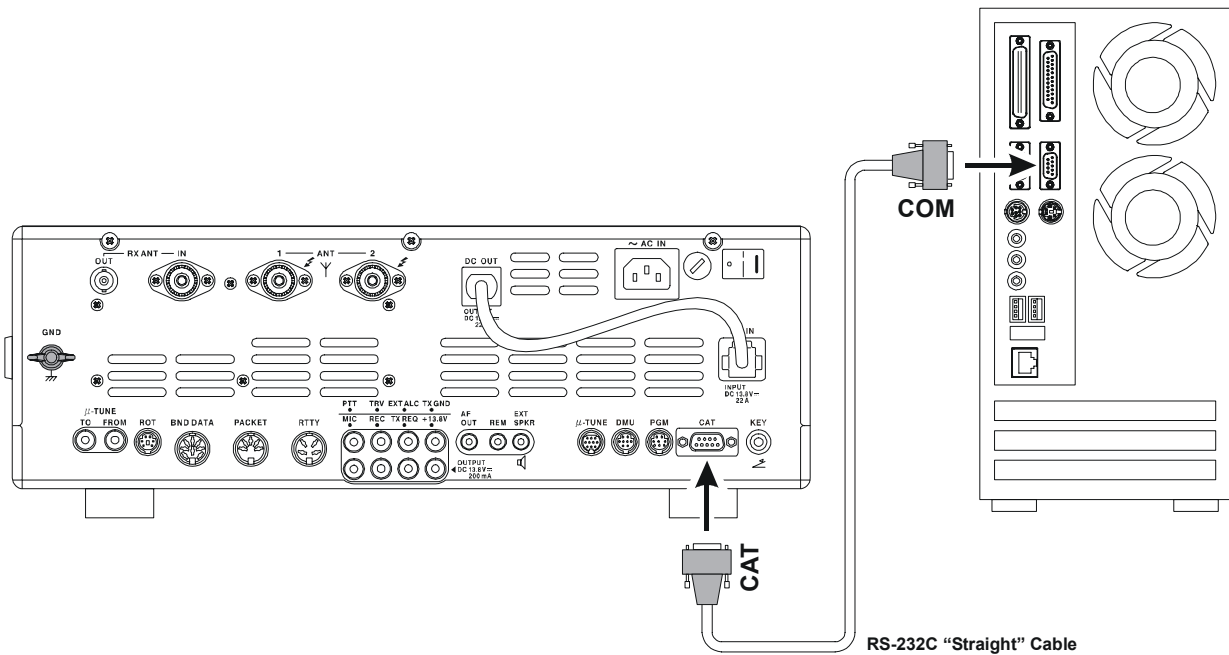

“PCC-2000” PERSONAL COMPUTER CONTROLLER WINDOW

If you double-click the left mouse button on each knob or switch of the following illustration, jump to the detailed page of the selected knob or switch.



PCC-2000 REFERENCE BOOK

OPENING/CLOSING THE PCC-2000 CONTROLLER PROGRAM

OPENING THE PCC-2000 PROGRAM

Double click the left mouse button on the “PCC-2000” icon. The “Vertex Standard” logo will appear for three seconds; afterwards the “PCC-2000” Personal Computer Controller will be opened.

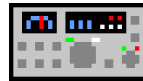

“PCC-2000” icon

CLOSING THE PCC-2000 PROGRAM

To close the “PCC-2000” Personal Computer Controller:

- ❑ Click the left mouse button on the Close Button “X” on the “PCC-2000” Personal Computer Controller.
- ❑ Click the left mouse button on the “Exit” parameter in the “File” menu on the “PCC-2000” Personal Computer Controller.
- ❑ Press the [ESC] button on the keyboard.



“EXIT” parameter



Close button

DATA CONNECTION

- ❑ Click the left mouse button on the [COM] button of the “PCC-2000” Personal Computer Controller to enable computer control. The yellow indicator will glow.
- ❑ Click the left mouse button on the [COM] button of the “PCC-2000” Personal Computer Controller again to disable computer control. The yellow indicator will go out.



[COM] button

SWITCHING POWER ON/OFF OF THE FT-2000

Click the left mouse button on the [ON/OFF] button of the “PCC-2000” Personal Computer Controller to turn the transceiver “On” and “Off.”

Note: the transceiver’s rear panel Power switch must already have been turned on manually.



[ON/OFF] button

AF GAIN CONTROL

MAIN BAND (VFO-A)

Click the left mouse button on the main [AF GAIN] knob (this turns the color of the “AF GAIN” image yellow), then turn the mouse scroll or press the left/right buttons to adjust the audio for a comfortable listening level.

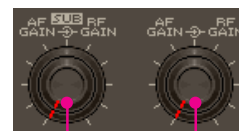

Sub [AF GAIN] knob

Main [AF GAIN] knob

SUB BAND (VFO-B)

Click the left mouse button on the sub [AF GAIN] knob (this turns the color of the sub “AF GAIN” image yellow), then turn the mouse scroll or press the left/right buttons to adjust the audio for a comfortable listening level.

SQL LEVEL CONTROL

MAIN BAND (VFO-A)

Click the left mouse button on the [SQL] knob (this turns the color of the “SQL” image yellow), then turn the mouse scroll, or press the left/right buttons, to adjust the squelch threshold level.



Main [SQL] knob

SUB BAND (VFO-B)

Click the left mouse button on the sub [SQL] knob (this turns the color of the sub “SQL” image yellow), then turn the mouse scroll, or press the left/right buttons, to adjust the squelch threshold level.



Sub [SQL] knob

PCC-2000 REFERENCE BOOK

FREQUENCY NAVIGATION ON THE MAIN BAND (VFO-A)

MAIN TUNING DIAL KNOB

- ❑ Bring the mouse cursor to the Main Tuning Dial knob, then turn the mouse scroll to tune the Main Band (VFO-A) frequency.
- ❑ Press and hold in the left mouse button on the edge of the Main Tuning Dial knob, then rotate the mouse, to tune the Main Band (VFO-A) frequency while holding in the left mouse button.



Main Tuning Dial knob

DIRECT FREQUENCY DIGIT SET

1. Click the left mouse button on the frequency digit which you wish to change on the Main Band (VFO-A) frequency. The frequency digit will change to Orange.
2. Turn the mouse scroll to tune the frequency digit of the Main Band (VFO-A) frequency.



Frequency Digit

BAND CHANGE

Click the left mouse button on the [BAND] button corresponding to the Amateur on which you wish to operate.



BAND keys

DIRECT KEYPAD FREQUENCY ENTRY

1. Click the left mouse button on the [ENT] button of the BAND keys. The “VFO SET” window will open.
2. Enter a frequency directly from the BAND keys or computer’s keyboard. Available entry values are 30000 - 60000000 (300 Hz - 60 MHz).
3. Click the left mouse button on the [OK] button of the “VFO SET” window or press the computer’s [ENTER] key to terminate the frequency entry.



[ENT] button

“VFO SET” window

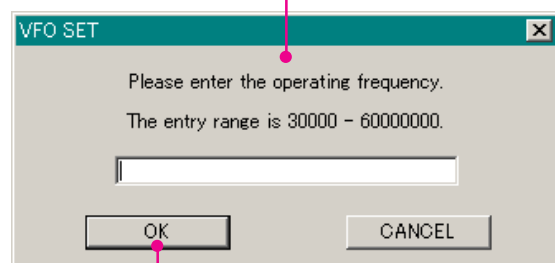

[OK] button

PCC-2000 REFERENCE BOOK

FREQUENCY NAVIGATION ON THE SUB BAND (VFO-B)

[SUB VFO-B] KNOB

- ❑ Click the left mouse button on the [A/B] button to enable the [SUB VFO-B] knob. Bring the mouse cursor to the [SUB VFO-B] knob, then turn the mouse scroll to tune the Sub Band (VFO-B) frequency.
- ❑ Click the left mouse button on the [A/B] button to enabling the [SUB VFO-B] knob. Press and hold in the left mouse button on the edge of the [SUB VFO-B] knob, then rotate the mouse, to tune the Sub Band (VFO-B) frequency while holding in the left mouse button.

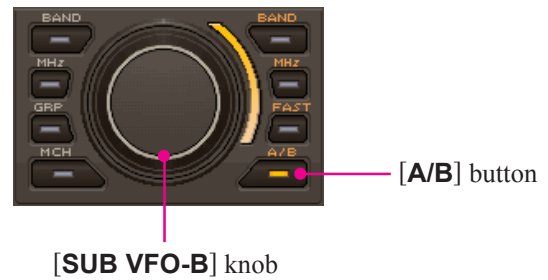

DIRECT FREQUENCY DIGIT SET

1. Click the left mouse button on the frequency digit which you wish to change on the Sub Band (VFO-B) frequency. The frequency digit will change to Orange.
2. Turn the mouse scroll to tune the frequency digit of the Sub Band (VFO-B) frequency.

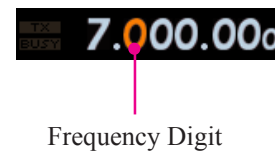

BAND CHANGE

Click the left mouse button on the [B] button, then click the left mouse button on the [BAND] button corresponding to the Amateur band on which you wish to operate.

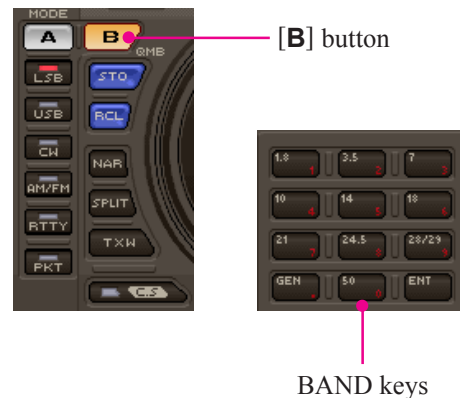

DIRECT KEYPAD FREQUENCY ENTRY

1. Click the left mouse button on the [B] button, then click the left mouse button on the [ENT] button of the BAND keys. The "VFO SET" window will open.
2. Enter a frequency directly by the BAND keys or computer's keyboard. Available entry values are 30000 - 60000000 (300 Hz - 60 MHz).
3. Click the left mouse button on the [OK] button of the "VFO SET" window or press the computer's [ENTER] key to terminate the frequency entry.

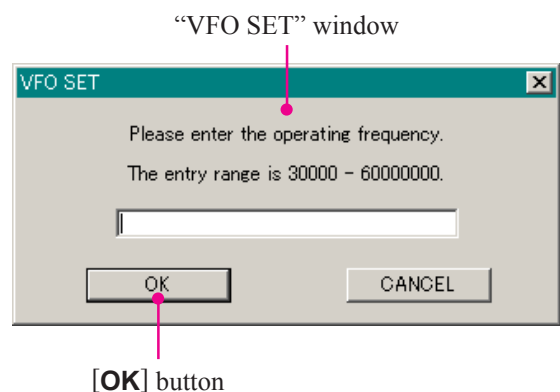
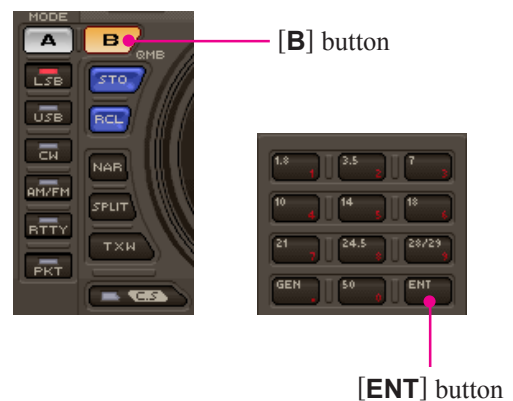

PCC-2000 REFERENCE BOOK

MODE SWITCH

- ❑ Click the left mouse button on the [MODE] button to select the desired operating mode for the Main band (VFO-A).
- ❑ Click the left mouse button on the [B] button, then click the left mouse button on the [MODE] button to select the desired operating mode for the Sub band (VFO-B).

Note:

- Click the [B] button repeatedly to toggle the operating mode between the “CW-U” and “CW-L” selections (CW with Upper Sideband or Lower Sideband BFO injection).
- Click the [AM/FM] button to toggle the operating mode between “AM” (inside of the button glows red) and “FM” (inside of the button glows orange).
- Click the [RTTY] button to toggle the operating mode between “RTTY-U” and “RTTY-L.”
- Click the [PKT] button to toggle the operating mode between “PKT-U,” “PKT-L,” and “PKT-FM.”

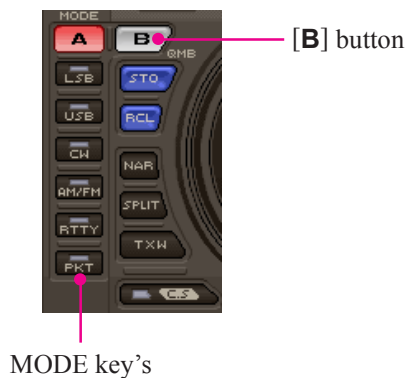

CLARIFIER OPERATION

RX CLAR SWITCH

Click the left mouse button on the [RX CLAR] button to turn the RX Clarifier on and off.

TX CLAR SWITCH

Click the left mouse button on the [TX CLAR] button to turn the TX Clarifier on and off.

CLEAR SWITCH

Click the left mouse button on the [CLEAR] button to clear the Clarifier offset frequency (thereby setting the offset to “Zero”).

CLAR KNOB

- ❑ Click the left mouse button on the [CLAR] knob, then turn the mouse scroll to tune the Clarifier offset frequency.
- ❑ Press and hold in the left mouse button on the edge of the [CLAR] knob, then rotate the mouse to tune the Clarifier offset frequency while holding in the left mouse button.

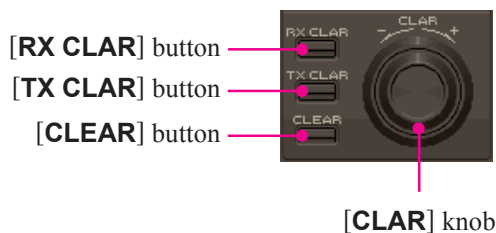

AUDIO PLAYBACK FEATURE

RECORDING

1. Click the left mouse button on the “Playback” parameter in the “Option” menu on the “PCC-2000” Personal Computer Controller to open the “Playback” pop-up window.
2. Click the left mouse button on the [REC] button of the Audio Playback feature to initiate recording.
3. Click the left mouse button on the [STOP] button of the Audio Playback feature to stop recording.

PLAYBACK

1. Click the left mouse button on the “Playback” parameter in the “Option” menu on the “PCC-2000” Personal Computer Controller to open the “Playback” pop-up window.
2. Click the left mouse button on the [PLAY] button of the Audio Playback feature to begin playback of the recorded audio.
3. Click the left mouse button on the [STOP] button of the Audio Playback feature to stop the playback.

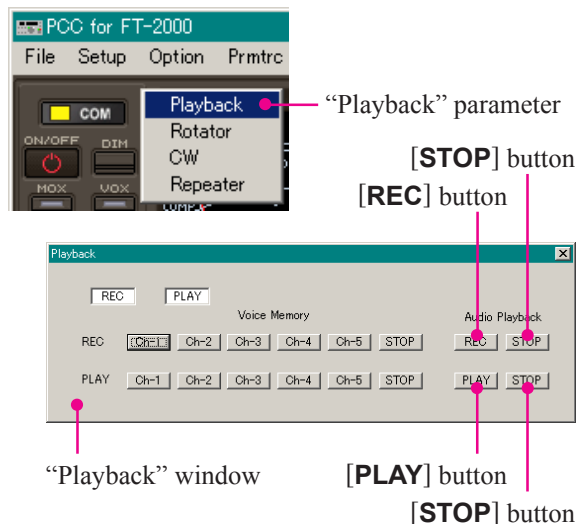

PCC-2000 REFERENCE BOOK

VOICE MEMORY FEATURE

RECORDING

1. Click the left mouse button on the “Playback” parameter in the “Option” menu on the “PCC-2000” Personal Computer Controller to open the “Playback” pop-up window.
2. Click the left mouse button on the desired Memory Channel button (REC [Ch-1] ~ REC [Ch-5]) for the Voice Memory feature to initiate recording.
3. Click the left mouse button on the [STOP] button for the Voice Memory feature to stop recording.

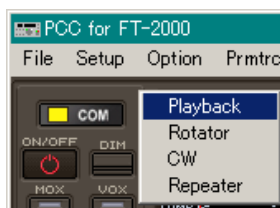

“Playback” parameter

PLAYBACK

1. Click the left mouse button on the “Playback” parameter in the “Option” menu on the “PCC-2000” Personal Computer Controller to open the “Playback” pop-up window.
2. Click the left mouse button on the desired Memory Channel button (PLAY [Ch-1] ~ PLAY [Ch-5]) for the Voice Memory feature to begin playback of the recorded audio.
3. Click the left mouse button on the [STOP] button for the Voice Memory feature to stop the playback.

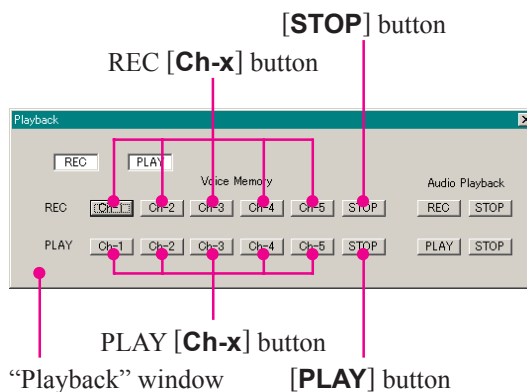

[STOP] button

REC [Ch-x] button

“Playback” window

[PLAY] button

ANTENNA SELECTION

Click the left mouse button on the [ANTENNA 1/2] button to open the “ANT” pop-up window, then select the antenna on which you wish to operate.

To use the RX ANT, repeatedly click the left mouse button on the [ANTENNA RX] button to turn the RX antenna on and off. When the RX antenna is selected, the “RX” icon will appear in the display.



[RX] button

[ANTENNA 1/2] button

IPO (INTERCEPT POINT OPTIMIZATION)

Click the left mouse button on the [IPO] button to open the “IPO” pop-up window, then select the front-end system you wish to use.

AMP1: low-distortion amplifier.

AMP2: 2-stage low-distortion amplifier.

IPO: bypasses the front end RF amplifier.



[IPO] button

“IPO” window

ATT (ATTENUATOR)

Click the left mouse button on the [ATT] button to open the “ATT” pop-up window, then select the attenuation level which you wish to utilize.



[ATT] button

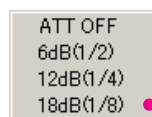

“ATT” window

PCC-2000 REFERENCE BOOK

RF GAIN CONTROL

MAIN BAND (VFO-A)

Click the left mouse button on the main [RF GAIN] knob (the indication color of “RF GAIN” will turn yellow), then turn the mouse scroll or press the left/right buttons to adjust the RF gain.

SUB BAND (VFO-B)

Click the left mouse button on the sub [RF GAIN] knob (the indication color of “RF GAIN” will turn yellow), then turn the mouse scroll or press the left/right buttons to adjust the RF gain.

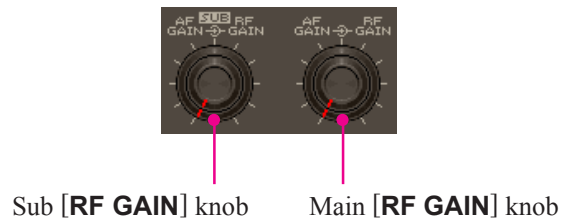

VRF (VARIABLE RF FRONT-END FILTER) OPERATION

1. Click the left mouse button on the [VRF] button to open the “VRF” pop-up window, then select the configuration you wish to use.

VRF OFF: Turns the VRF filter off.

VRF ON: Turns the VRF filter on.

DEFAULT: Moves the passband of the VRF filter to the center of the current amateur band.

2. When you have set the [VRF] button to “VRF ON:”

Bring the mouse cursor to the [VRF] knob, then turn the mouse scroll to move the passband of the VRF filter.

Press and hold in the left mouse button on the edge of the [VRF] knob, then rotate the mouse to move the passband of the VRF filter while holding the left mouse button.

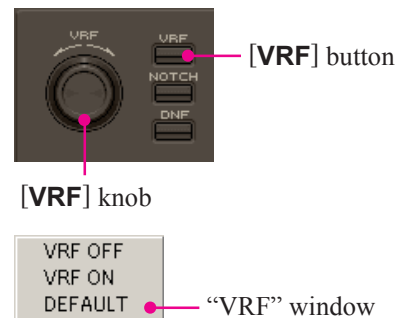

ROOFING FILTER SELECTION

Click the left mouse button on the [R.FLT] button to open the “Roofing Filter” pop-up window, then select the bandwidth you wish to utilize.

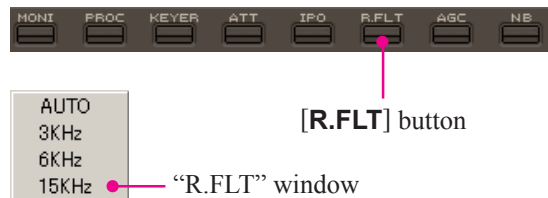

CONTOUR FILTER / APF (AUDIO PEAK FILTER) OPERATION

1. Click the left mouse button on the [CONT] button to open the “Contour/APF” pop-up window, then select the configuration you wish to use.

OFF: Turns the Contour filter/APF both off.

CONTOUR: Turns the Contour filter on. The Contour filter characteristic will appear in the display

APF: Turns the APF (Audio Peak Filter) filter on. The APF is activated only with a CW mode. The “CONTOUR” indication on the display will change to “APF”.

2. When the Contour filter is set to on, click the left mouse button on the edge of the [CONTOUR] knob (the indication color of “CONTOUR” will turn yellow), then turn the mouse scroll or press the left/right buttons to adjust the center frequency of the Contour filter (There is no adjustmet knob associated with the APF).

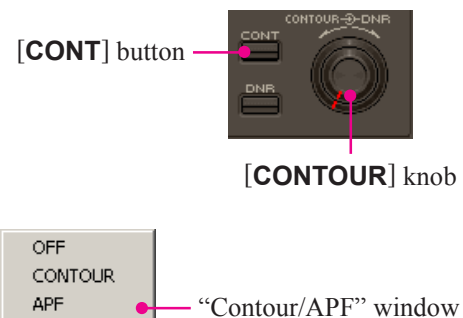

PCC-2000 REFERENCE BOOK

IF SHIFT OPERATION

Click the left mouse button on the edge of the **[SHIFT]** knob (the indication color of “SHIFT” will turn yellow), then turn the mouse scroll or press the left/right buttons to move the filter passband.

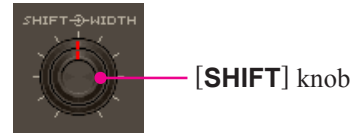

WIDTH OPERATION

Click the left mouse button on the edge of the **[WIDTH]** knob (the indication color of “WIDTH” will turn yellow), then turn the mouse scroll or press the left/right buttons to adjust the filter bandwidth.



NOTCH OPERATION

1. Click the left mouse button on the **[NOTCH]** button to turn the Notch filter on and off. When the Notch filter is set to on, the Notch characteristic will appear in the display.
2. Click the left mouse button on the edge of the **[COARSE]** knob (the indication color of “COARSE” will turn yellow), then turn the mouse scroll or press the left/right buttons to perform coarse adjustment of the center frequency of the IF Notch filter.
3. Click the left mouse button on the edge of the **[FINE]** knob (the indication color of “FINE” will turn yellow), then turn the mouse scroll or press the left/right buttons to make fine adjustments to the center frequency of the IF Notch filter.

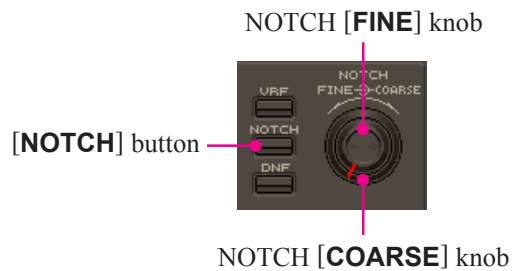

AUTO NOTCH OPERATION

Click the left mouse button on the **[DNF]** button to turn the Auto Notch filter on and off. When the Auto Notch filter is set to on, the “DNF” icon will appear in the display.

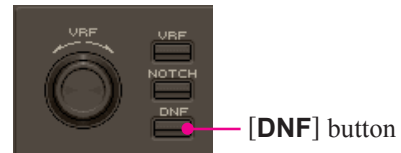

NOISE REDUCTION OPERATION

1. Click the left mouse button on the **[DNR]** button to turn the Digital Noise Reduction system on and off. When the Digital Noise Reduction system is set to on, the “DNR” icon will appear in the display.
2. Click the left mouse button on the edge of the **[DNR]** knob (the font color of “DNR” will change to yellow), then turn the mouse scroll or press the left/right buttons to select the setting that most effectively reduces the noise level.

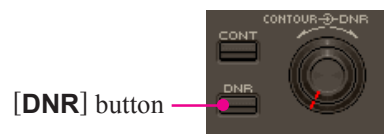

PCC-2000 REFERENCE BOOK

NAR (ONE-TOUCH NARROW IF FILTER SELECTION)

MAIN BAND (VFO-A)

1. Click the left mouse button on the **[NAR]** button to engage the preset “Narrow” IF filter selection. When the narrow bandwidth is engaged, the “NAR” indication will appear in the display.
2. Click the left mouse button on the **[NAR]** button again; the bandwidth will revert to that set by the **[WIDTH]** knob.

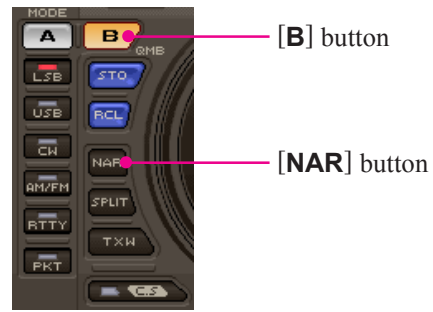

SUB BAND (VFO-B)

1. Click the left mouse button on the **[B]** button.
2. Within five seconds of clicking the **[B]** button (while the imbedded orange indicator is illuminated), click the left mouse button on the **[NAR]** button to toggle the bandwidth between “Wide” and “Narrow.” When the “Narrow” option is selected, the “NAR” icon will appear in the display.

NOISE BLANKER OPERATION

MAIN BAND (VFO-A)

1. Click the left mouse button on the **[NB]** button to open the “NB” pop-up window, then select the configuration you wish to use.

NB OFF: Turns the Noise Blanker off.

NB ON: Turns the Noise Blanker on (for short-duration pulses).

NB-W ON: Turns the Noise Blanker on (for longer-duration pulses).

2. When you have set the **[NB]** button to “NB ON” or “NB-W ON,” click the left mouse button on the **[NB]** knob (the indication color of “NB” will turn yellow), then turn the mouse scroll or press the left/right buttons to select the noise blanking level.

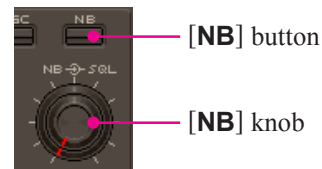

SUB BAND (VFO-B)

1. Click the left mouse button on the **[B]** button, then click the left mouse button on the **[NB]** button to open the “NB” pop-up window; now select the configuration you wish to use.

NB OFF: Turns the Noise Blanker off.

NB ON: Turns the Noise Blanker on (for short-duration pulses).

NB-W ON: Turns the Noise Blanker on (for longer-duration pulses).

2. When you have set the **[NB]** button to “NB ON” or “NB-W ON,” left-click on the **[B]** button followed by the **[NB]** knob (the indication color of “NB” will turn yellow), then turn the mouse scroll or press the left/right buttons to select the desired noise blanking level.

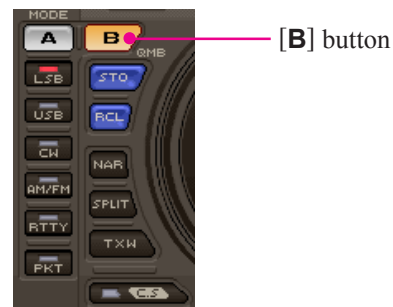

PCC-2000 REFERENCE BOOK

AGC

SUB BAND (VFO-B)

Click the left mouse button on the **[AGC]** button to open the “AGC” pop-up window, then select the desired receiver-recovery time.

SUB BAND (VFO-B)

Click the left mouse button on the **[B]** button, and then click the left mouse button on the **[AGC]** button to open the “AGC” pop-up window; now select the desired receiver-recovery time.



[AGC] button



[B] button

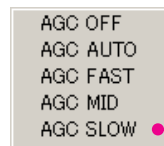

“AGC” window

LOCK FEATURE

Click the left mouse button on the **[LOCK]** button to turn the Main Tuning Dial knob Lock “on” and “off.” When the Main Tuning Dial knob is set to be locked, the “LOCK” icon will appear in the display.



[LOCK] button

VOX OPERATION

1. Click the left mouse button on the **[VOX]** button to turn the VOX circuit on and off. When the VOX circuit is set to on, the inside of the button glows red.
2. Click the left mouse button on the **[VOX]** knob (the indication color of “VOX” will turn yellow), then turn the mouse scroll or press the left/right buttons to adjust the VOX gain.
3. Click the left mouse button on the **[DELAY]** knob (the indication color of “DELAY” will turn yellow), then turn the mouse scroll or press the left/right buttons to adjust the hang time of the VOX circuit.



[VOX] button



[VOX] knob

[DELAY] knob

PCC-2000 REFERENCE BOOK

USING THE SPEECH PROCESSOR

1. Click the left mouse button on the **[PROC]** button to open the “PROCESSOR” pop-up window, then select the configuration you wish to use.

OFF: Turns the Speech Processor off.

MIC-EQ: Turns the Speech Processor on, with the Parametric Microphone Equalizer. You may adjust the characteristic of the Parametric Microphone Equalizer by the “Prmtrc” menu. See page 15 for details.

Note: This configuration is only selected on the **FT-2000D** (200 W version).

PROC: Turns the Speech Processor on.

2. Click the left mouse button on the **[PROC]** knob (the indication color of “PROC” will turn yellow), then turn the mouse scroll or press the left/right buttons to select the Compression level.

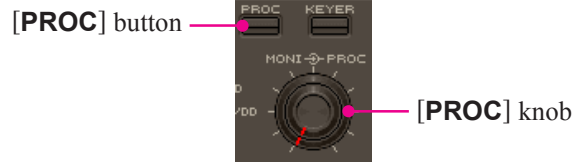

USING THE MONITOR

1. Click the left mouse button on the **[MONI]** button to turn the Monitor circuit on and off. When the Monitor is set to on, the “MONI” icon will appear in the display.
2. Click the left mouse button on the **[MONI]** knob (the indication color of “MONI” will turn yellow), then turn the mouse scroll or press the left/right buttons to adjust the Monitor level.

[MONI] button

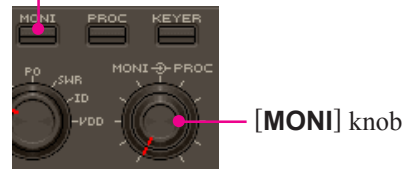

ANTENNA TUNER OPERATION

Click the left mouse button on the **[TUNE]** button to open the “TUNER” pop-up window, then select the configuration you wish to use.

TUNER OFF: Turns the Automatic Antenna Tuner off.

TUNER ON: Turns the Automatic Antenna Tuner on.

TUNING: Turns the Automatic Antenna Tuner on, and begins the automatic tuning process.

[TUNE] button



PCC-2000 REFERENCE BOOK

REPEATER OPERATION

1. Click the left mouse button on the “Repeater” parameter in the “Option” menu on the “PCC-2000” Personal Computer Controller to open the “Repeater” pop-up window.
2. Click the left mouse button on the [ENC], [SQL], or [OFF] button to select the desired CTCSS mode.
3. Click the left mouse button on the “Freq” button to open the “CTCSS Tone Frequency” pop-up window, and then select the desired tone frequency.
4. Click the [OK] button to close the “CTCSS Tone Frequency” pop-up window.
5. Click the left mouse button on the [S], [-], or [+] button to select the desired Repeater Shift Direction.
6. Click the left mouse button on the Close Button “X” on the “Repeater” pop-up window to save the new setting and close the “Repeater” pop-up window.

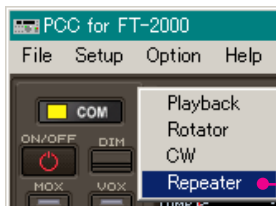

“Repeater” window

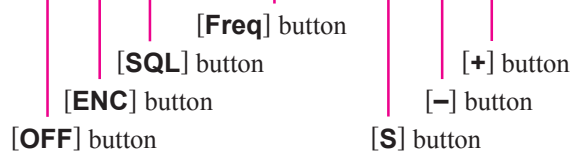
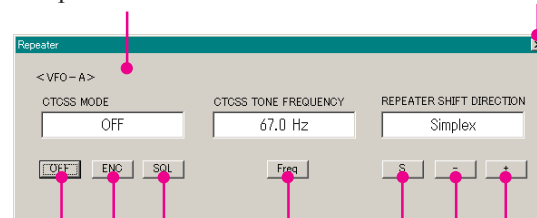

“CTCSS Tone Frequency” window

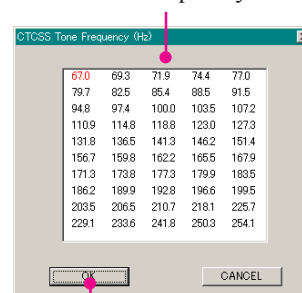

[OK] button

PCC-2000 REFERENCE BOOK

PARAMETRIC MICROPHONE EQUALIZER ADJUSTMENT

1. Click the left mouse button on the “Prmtrc” menu on the “PCC-2000” Personal Computer Controller to open the “Parametric” pop-up window, then select the configuration you wish to use.

Prmtrc: Adjust the characteristic of the Parametric Microphone Equalizer when the Speech Processor is disabled.

P-Prmtrc: Adjust the characteristic of the Parametric Microphone Equalizer when the Speech Processor is enabled.

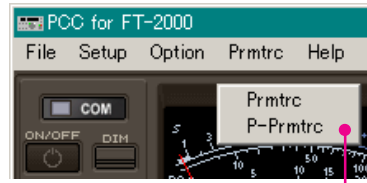

“Parametric” window

2. When click the left mouse button on the “Prmtrc” or “P-Prmtrc” menu, open the “Parametric Microphone Equalizer Graph” window on the monitor.
3. Adjust the characteristic of the Parametric Microphone Equalizer using the each arrow switch. You may observe the setting of the characteristic of the Parametric Microphone Equalizer on the monitor.
Red Curve: Appears the characteristic of the lower range for the parametric microphone equalizer.
Blue Curve: Appears the characteristic of the middle range for the parametric microphone equalizer.
Green Curve: Appears the characteristic of the high range for the parametric microphone equalizer.
Black Curve: Appears the characteristic of the overall range for the parametric microphone equalizer.
4. Click the left mouse button on the [APPLI] button on the “Parametric Microphone Equalizer Graph” window to save the new setting and click the left mouse button on the [EXIT] button on the “Parametric Microphone Equalizer Graph” window to close the “Parametric Microphone Equalizer Graph” window.

“Parametric Microphone Equalizer Graph” window

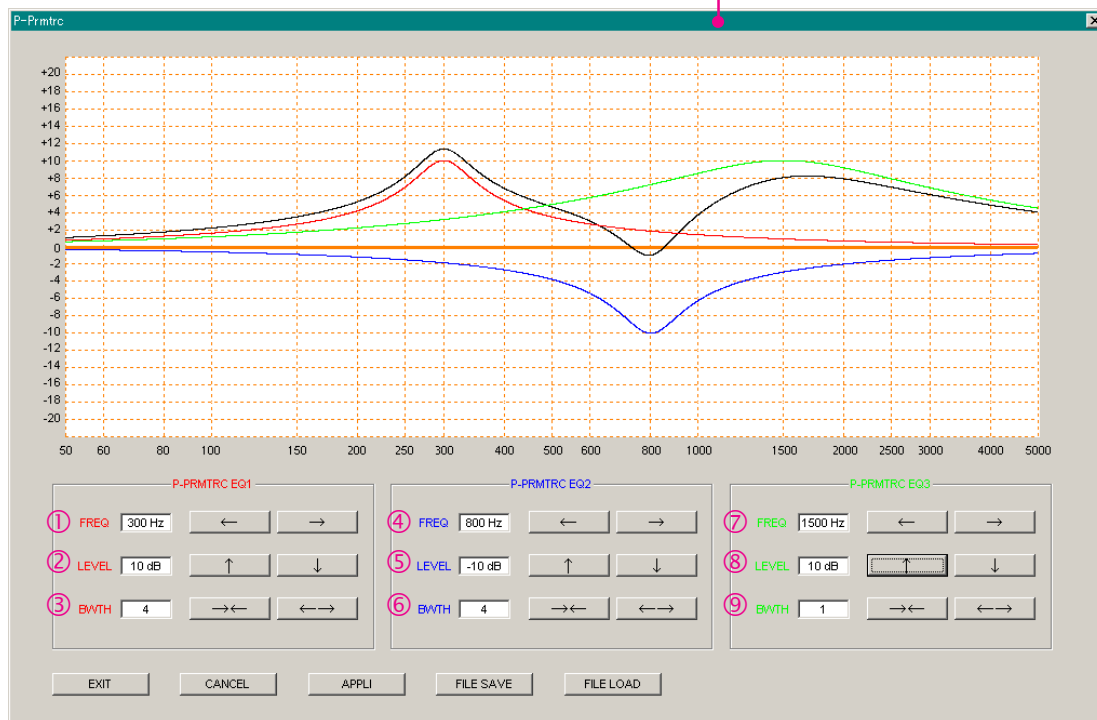

① PRMTRC EQ1 (P-PRMTRC EQ1) FREQ

Click the left mouse button on the [←]/[→] button to selects the center frequency of the lower range for the parametric microphone equalizer.

Available selections are 100 ~ 700 Hz (100 Hz/step) or OFF.

② PRMTRC EQ1 (P-PRMTRC EQ1) LEVEL

Click the left mouse button on the [↑]/[↓] button to adjusts the equalizer gain of the low range of the parametric microphone equalizer.

Available selections are -20 dB ~ +10 dB.

③ PRMTRC EQ1 (P-PRMTRC EQ1) BWTH

Click the left mouse button on the [→←]/[←→] button to adjusts the Q-factor of the low range of the parametric microphone equalizer.

Available selections are 1 ~ 10.

PCC-2000 REFERENCE BOOK

PARAMETRIC MICROPHONE EQUALIZER ADJUSTMENT

④ PRMTRC EQ2 (P-PRMTRC EQ2) FREQ

Click the left mouse button on the [←]/[→] button to select the center frequency of the middle range for the parametric microphone equalizer.

Available selections are 700 ~ 1500 Hz (100 Hz/step) or OFF.

⑤ PRMTRC EQ2 (P-PRMTRC EQ2) LEVEL

Click the left mouse button on the [↑]/[↓] button to adjust the equalizer gain of the middle range of the parametric microphone equalizer.

Available selections are -20 dB ~ +10 dB.

⑥ PRMTRC EQ2 (P-PRMTRC EQ2) BWTH

Click the left mouse button on the [→←]/[←→] button to adjust the Q-factor of the middle range of the parametric microphone equalizer.

Available selections are 1 ~ 10.

⑦ PRMTRC EQ3 (P-PRMTRC EQ3) FREQ

Click the left mouse button on the [←]/[→] button to select the center frequency of the high range for the parametric microphone equalizer.

Available selections are 1500 ~ 3200 Hz (100 Hz/step) or OFF.

⑧ PRMTRC EQ3 (P-PRMTRC EQ3) LEVEL

Click the left mouse button on the [↑]/[↓] button to adjust the equalizer gain of the high range of the parametric microphone equalizer.

Available selections are -20 dB ~ +10 dB.

⑨ PRMTRC EQ3 (P-PRMTRC EQ3) BWTH

Click the left mouse button on the [→←]/[←→] button to adjust the Q-factor of the high range of the parametric microphone equalizer.

Available selections are 1 ~ 10.

[EXIT] Button

Click the left mouse button on this button to close the “Repeater” pop-up window.

[CANCEL] Button

Click the left mouse button on this button to save the new setting.

[APPLI] Button

Click the left mouse button on this button to save the new setting.

[FILE SAVE] Button

Click the left mouse button on this button to open the “File Save” pop-up window and save the new setting to your computer (pef file).

[FILE LOAD] Button

Click the left mouse button on this button to open the “File Load” pop-up window and load the previously stored setting.

KEYER OPERATION

1. Click the left mouse button on the [KEYER] button to turn the CW Keyer on and off. When the CW Keyer is set to on, the “KEYER” icon will appear in the display.
2. Click the left mouse button on the [SPEED] knob (the indication color of “SPEED” will turn yellow), then turn the mouse scroll or press the left/right buttons to set the desired keying speed.
3. Click the left mouse button on the [PITCH] knob (the indication color of “PITCH” will turn yellow), then turn the mouse scroll or press the left/right buttons to set the desired CW tone pitch.
4. Click the left mouse button on the [BK-IN] button to turn the CW Break-in circuit on and off. When the CW Break-in circuit is set to on, the “BK-IN” icon will appear in the display.
5. Click the left mouse button on the [DELAY] knob (the indication color of “DELAY” will turn yellow), then turn the mouse scroll or press the left/right buttons to adjust the CW delay time.



[KEYER] button

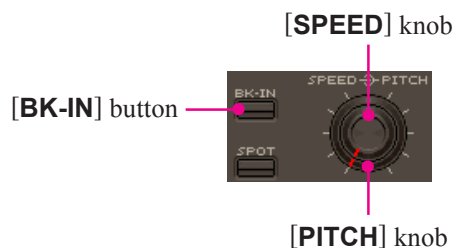

[BK-IN] button

[PITCH] knob



[DELAY] knob

PCC-2000 REFERENCE BOOK

CONTEST MEMORY KEYS

TEXT MEMORY STORAGE

1. Click the left mouse button on the “CW” parameter in the “Option” menu on the “PCC-2000” Personal Computer Controller to open the “CW” pop-up window.
2. Click the left mouse button on the desired Text Memory Channel (“Text Ch-1” ~ “Text Ch-5”), then enter the message from the computer’s keyboard. Remember to add the “}” character at the end to signify the termination of the message.
3. Click the left mouse button on the [CH-x WR] button to save the message.

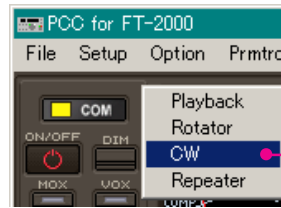

“CW” parameter

PLAYBACK

1. Click the left mouse button on the “Playback” parameter in the “Option” menu on the “PCC-2000” Personal Computer Controller to open the “Playback” pop-up window.
2. Click the left mouse button on the desired Memory Channel button (Message Play [Ch-1] ~ Message Play [Ch-5] or Text Play [Ch-1] ~ Text Play [Ch-5]) to begin playback of the recorded audio.

“Message Play” button’s “Text Play” button’s

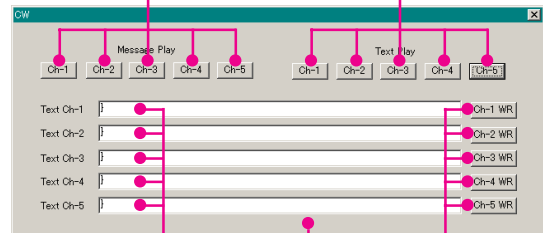

Text Memory Channel

[CH-x WR] button

“CW” window

ROTATOR CONTROL

1. Click the left mouse button on the “Rotator” parameter in the “Option” menu on the “PCC-2000” Personal Computer Controller to open the “Rotator” pop-up window.
2. Click the left mouse button on the [CCW] or [CW] button to rotate the antenna.
3. Click the left mouse button on the [SLOW] or [FAST] button to adjust the rotation speed.

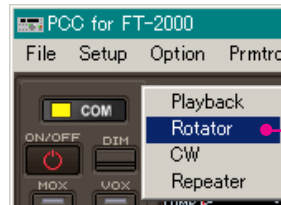

“Rotator” parameter

“Rotator” window

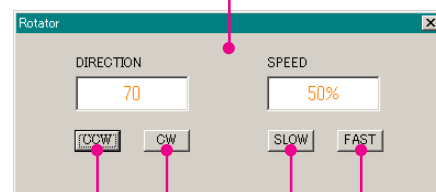

[CW] button

[FAST] button

[CCW] button

[SLOW] button

QMB MEMORY

- ❑ Click the left mouse button on the [STO] button to write the current main band (VFO-A) data to the QMB memory.
- ❑ Click the left mouse button on the [RCL] button to recall the QMB memory.



[STO] button

[RCL] button

PCC-2000 REFERENCE BOOK

OPERATION OF MISCELLANEOUS KNOBS AND BUTTONS

[METER] KNOB

Click the left mouse button on the [METER] knob, then turn the mouse scroll or press the left/right buttons to select the function of the meter during transmission.

[MIC] KNOB

Click the left mouse button on the [MIC] knob (the indication color of “MIC” will turn yellow), then turn the mouse scroll or press the left/right buttons to select the Microphone gain level.

[RF PWR] KNOB

Click the left mouse button on the [RF PWR] knob (the indication color of “RF PWR” will turn yellow), then turn the mouse scroll or press the left/right buttons to set the desired output power.

[DIM] BUTTON

Click the left mouse button on the [DIM] button to toggle the illumination level of the Meter/Display between “Hi” and “Low.”

[MOX] BUTTON

Click the left mouse button on the [MOX] button to engage transmission. When the MOX circuit is set to on, the inside of the button glows red.

[SPOT] BUTTON

Click the left mouse button on the [SPOT] button to turn on the CW receiver spotting tone.

[A] BUTTON

When this button glows red, the following buttons are active on the Main Band (VFO-A).

- [MODE] Button
- [BAND] Button
- [NAR] Button
- [AGC] Button
- [NB] Button
- [NB] Knob

[B] BUTTON

Click the left mouse button on the [B] button to turn the button orange for five seconds. When this button glows orange, the following buttons are active on the Sub Band (VFO-B).

- [MODE] Button
- [BAND] Button
- [NAR] Button
- [AGC] Button
- [NB] Button
- [NB] Knob

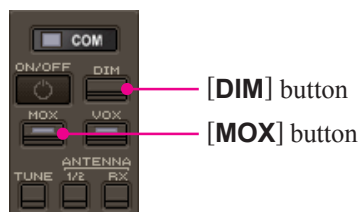
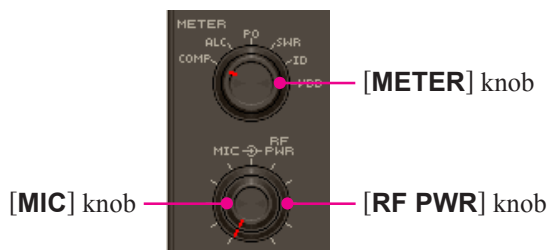

PCC-2000 REFERENCE BOOK

OPERATION OF MISCELLANEOUS KNOBS AND BUTTONS

[SPLIT] BUTTON

Click the left mouse button on the [SPLIT] button to open the "SPLIT" pop-up window, then select the configuration you wish to use.

SPLIT: Toggle the Split Frequency operation on and off. The VFO-A will be used for reception, and VFO-B will be used for transmission.

QUICK SPLIT: Activates the Quick Split feature. (Sub (VFO-B) register will automatically be set to a frequency 5 kHz higher than the Main (VFO-A) register with same operating mode.)



[TXW] BUTTON

Click the left mouse button on the [TXW] button to monitor the transmit frequency when split frequency operation is engaged. Release the mouse button to return to normal operation.

MAIN [RX] BUTTON

Click the left mouse button on the Main [RX] button to toggle the Main Band (VFO-A) receiver on and off. When the Main Band (VFO-A) receiver is set to on, the button glows green.

MAIN [TX] BUTTON

Click the left mouse button on the Main [TX] button to toggle transmitter control between the "Main Band (VFO-A)" and "Sub Band (VFO-B)." When the transmitter control is set to "Main Band (VFO-A)," this button glows red.

SUB [RX] BUTTON

Click the left mouse button on the Sub [RX] button to toggle the Sub Band (VFO-B) receiver on and off. When the Sub Band (VFO-B) receiver is set to on, this button glows green.

SUB [TX] BUTTON

Click the left mouse button on the Sub [TX] button to toggle transmitter control between the "Main Band (VFO-A)" and "Sub Band (VFO-B)." When the transmitter control is set to "Sub Band (VFO-B)," this button glows red.

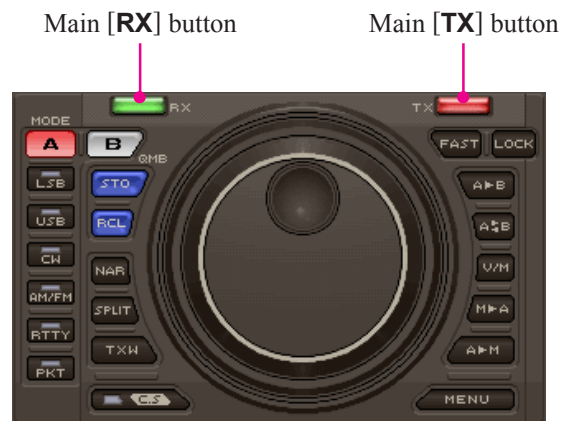

Sub [RX] button Sub [TX] button



PCC-2000 REFERENCE BOOK

OPERATION OF MISCELLANEOUS KNOBS AND BUTTONS

[FAST] BUTTON

Click the left mouse button on the [FAST] button to toggle the tuning rate of the Main Tuning Dial knob between “Fast” and “Slow.” When the tuning rate is set to “Fast,” the “FAST” icon will appear in the display.

[A▶B] BUTTON

Click the left mouse button on the [A▶B] button to transfer data from the Main band (VFO-A) frequency (or a recalled memory channel) to the Sub band (VFO-B).

[A◀B] BUTTON

Click the left mouse button on the [A◀B] button to exchange the contents of the Main band (VFO-A) (or a recalled memory channel) and the Sub band (VFO-B).

[V/M] BUTTON

Click the left mouse button on the [V/M] button to toggle the Main band (VFO-A) receiver operation between the memory system and the VFO.

[M▶A] BUTTON

Click the left mouse button on the [M▶A] button to copy the data from the currently-selected memory to the Main VFO (VFO-A).

[A▶M] BUTTON

Click the left mouse button on the [A▶M] button to copy the current operating data from the Main band (VFO-A) into the currently selected memory channel, overwriting any previous data stored there.

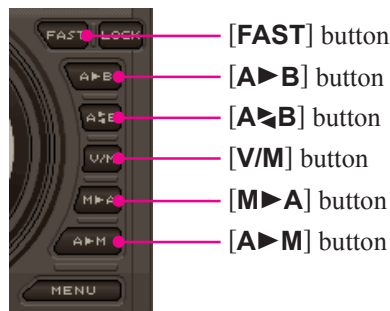

MAIN (VFO-A) [BAND] BUTTON

Clicking the left mouse button on the Main (VFO-A) [BAND] button (the inside of the button will glow red) allows you to select the Main (VFO-A) operating band (Amateur bands) using the [SUB VFO-B] knob.

MAIN (VFO-A) [MHz] BUTTON

Clicking the left mouse button on the Main (VFO-A) [MHz] button (the inside of the button will glow red) allows you to turn the Main (VFO-A) frequency down or up in 1 MHz increments, using the [SUB VFO-B] knob.

[GRP] BUTTON

Clicking the left mouse button on the [GRP] button (the inside of the button will glow red) allows you to select the memory group using the [SUB VFO-B] knob.

[MCH] BUTTON

Clicking the left mouse button on the [MCH] button (the inside of the button will glow red) allows you to select the memory channel using the [SUB VFO-B] knob.

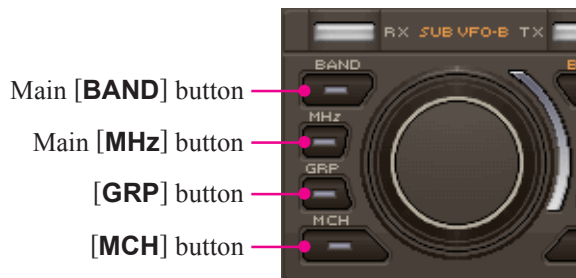

PCC-2000 REFERENCE BOOK

OPERATION OF MISCELLANEOUS KNOBS AND BUTTONS

SUB (VFO-B) [BAND] BUTTON

Clicking the left mouse button on the Sub (VFO-B) [BAND] button (the inside of the button will glow orange) allows you to select the Sub (VFO-B) operating band (Amateur bands) using the [SUB VFO-B] knob.

SUB (VFO-B) [MHz] BUTTON

Clicking the left mouse button on the Sub (VFO-B) [MHz] button (the inside of the button will glow orange) allows you to turn the Sub (VFO-B) frequency down or up in 1 MHz increments, using the [SUB VFO-B] knob.

[FAST] BUTTON

Clicking the left mouse button on the [FAST] button (the inside of the button will glow orange) increases the tuning rate of the [SUB VFO-B] knob by a factor of 10.

[A/B] BUTTON

Click the left mouse button on the [A/B] button to toggle the actions of the [SUB VFO-B] button between the “Main band (VFO-A)” and “Sub band (VFO-B).”

[DISPLAY] BUTTON

Click the left mouse button on the [DISPLAY] button to open the “Display Page” pop-up window, and then select the display page which you wish to engage for operation. This requires that the optional DMU-2000 Data Management Unit be installed in the transceiver.

WORLD CLOCK DISPLAY:

SPECTRUM SCOPE DISPLAY:

AF SCOPE/OSCILLOSCOPE DISPLAY:

LOG BOOK DISPLAY:

TEMPERATURE/SWR DISPLAY:

ROTATOR DISPLAY:

MEMORY CHANNEL DISPLAY:

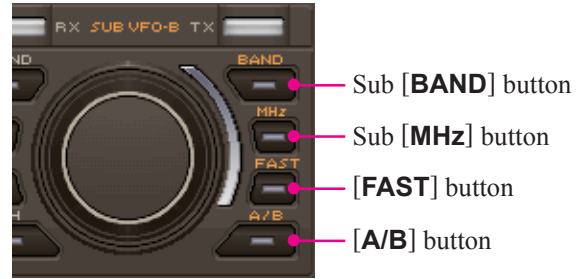

Sub [BAND] button

Sub [MHz] button

[FAST] button

[A/B] button

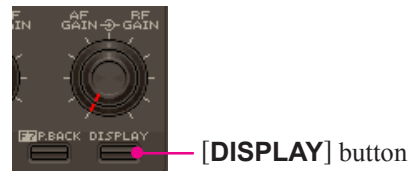

[DISPLAY] button

WORLD CLOCK DISPLAY
SPECTRUM SCOPE DISPLAY
AF SCOPE/OSCILLOSCOPE DISPLAY
LOG BOOK DISPLAY
TEMPERATURE/SWR DISPLAY
ROTATOR DISPLAY
MEMORY CHANNEL LIST DISPLAY

“Display Page” window

PCC-2000 REFERENCE BOOK

MENU OPERATION

1. Click the left mouse button on the [MENU] button to open the “MENU” window.
2. Turn the mouse scroll to select the Menu item you wish to work on, then double click the left mouse button on the Menu item to open the pop-up window.
3. Change the current setting of the selected Menu item, then click the [OK] button to close the pop-up window.
4. Click the [OK] button to save the new setting and close the “MENU” window.



[MENU] button

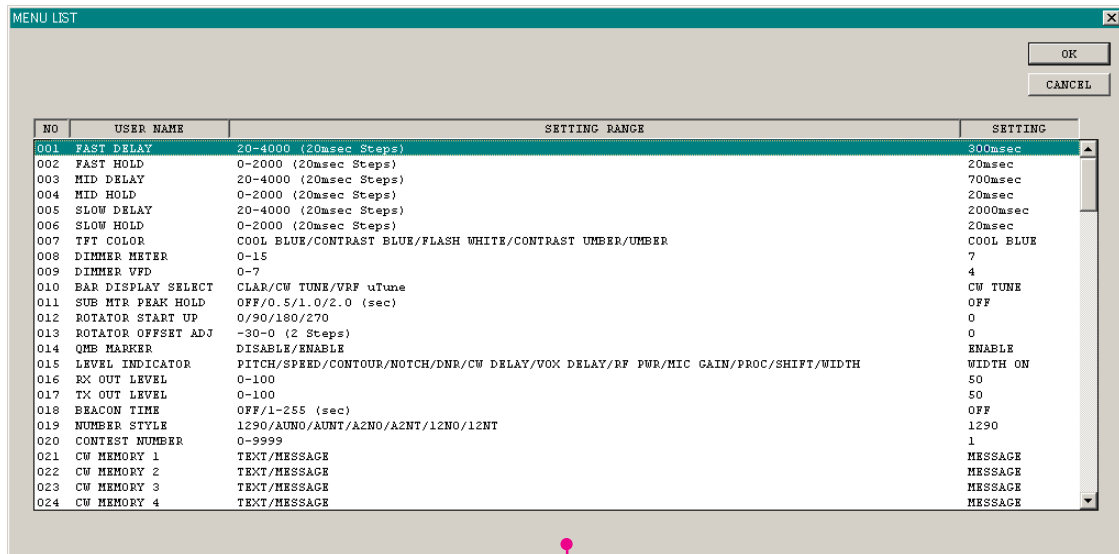

“MENU LIST” window

“MENU LIST SETTING” window

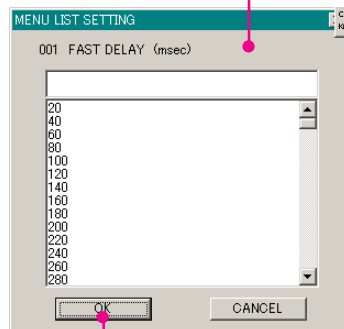

[OK] button

PCC-2000 REFERENCE BOOK

COMMAND SEND

1. Click the left mouse button on the “Command Send” parameter in the “File” menu on the “PCC-2000” Personal Computer Controller to open the “Command Send” pop-up window.
2. Enter the CAT command you wish send to the FT-2000 with the PC keyboard.

For example: Set the VFO-A frequency to 14.250000 MHz.
FA14250000;

Refer to a “FT-2000 CAT Operation Reference Book” for the CAT command.

3. Click the **[OK]** button to send the CAT command to the transceiver and close the pop-up window.



“COMMAND SEND” parameter

“Command Send” window

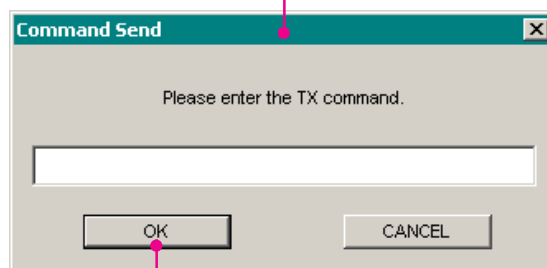

[OK] button

PCC-2000 REFERENCE BOOK

FUNCTION KEY OPERATION

You can program and assign the CAT commands into your computer's Function keys using the Vertex Standard **KSE4PCC** Keyboard Shortcut Editor, then you may control the transceiver by pressing your computer's Function keys while activating the "PCC-2000" Personal Computer Controller.

Each of the following 46 Function keys may be programmed with a CAT command sequence. There are a total of 52 commands to choose from:

- [F2] key ~ [F9] key, [F11] key, [F12] key,
- [Shift] + [F1] key ~ [Shift] + [F9] key, [Shift] + [F11] key, [Shift] + [F12] key,
- [Cntl] + [F1] key ~ [Cntl] + [F9] key, [Cntl] + [F11] key, [Cntl] + [F12] key,
- [Alt] + [F1] key ~ [Alt] + [F3] key, [Alt] + [F5] key, [Alt] + [F7] key ~ [Alt] + [F12] key,
- [Page Up] key, [Page Down] key, [Home] key, and [End] key

Following is an example of programming a CAT command shortcut into one of the Function keys:

1. Copy the "KSE4PCC.exe" file into the folder where you installed the "PCC-2000.exe" file.
2. Double click the left mouse button on "KSE4PCC.exe" to open the "Keyboard Shortcut Editor" pop-up window.
3. Enter the CAT command you wish to assign to a specific Function key.

Example 1: Set the VFO-A frequency to 14.250000 MHz.

FA14250000;

Example 2: Set the VFO-A Operating Mode to "USB".

MD02;

Example 3: Set the VFO-A frequency to 14.250000 MHz, USB mode.

FA14250000; MD02;

(Notice in Example 3 that you may assign more than one CAT command to a single function key. Simply add a semi-colon after each command, and end the command line with a semi-colon).

Refer to the "FT-2000 CAT Operation Reference Book" for the CAT command.

Note: You can not enter CAT commands into the following function keys.

- [F1] key, [F10] key, [Shift] + [F10] key,
- [Cntl] + [F10] key, [Alt] + [F4] key, and [Alt] + [F6] key

4. You may append an Alpha-numeric "Tag" to a CAT Command for your reference (This is for reference only. The Alpha-numeric "Tag" is not displayed on the "PCC-2000" Personal Computer Controller).

To append a "Tag" to your CAT shortcut key, click the left mouse button on the "Tag" or the "Both" parameter in the "View" menu on the "Keyboard Shortcut Editor". Your new reference "Tag" appears in the "Tag" column on the "Keyboard Short-cut Editor".

5. To close the "Keyboard Shortcut Editor" and save the CAT commands, click "File" in the menu bar, and then click "Save" in the drop-down list. In the Confirmation pop-up window, click the [Yes] button to save the new setting.

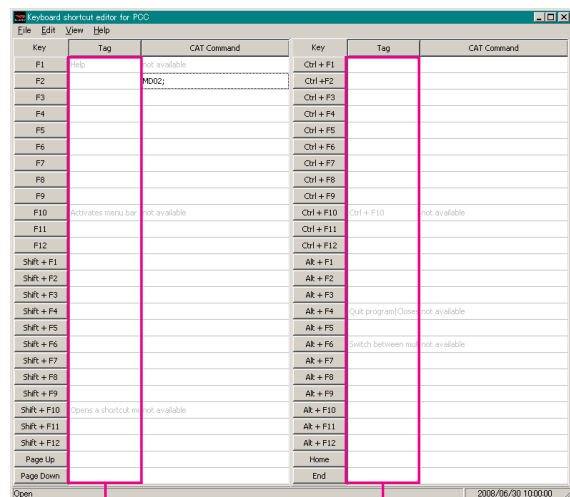
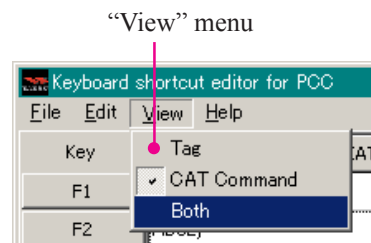
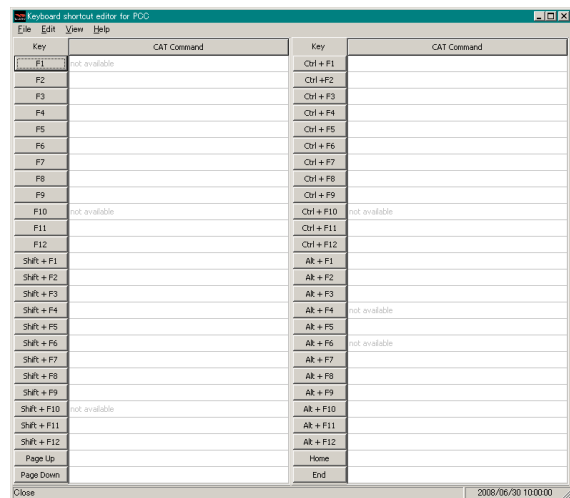

"Tag" column

"Tag" column

PCC-2000 REFERENCE BOOK

NOTE



Copyright 2009
VERTEX STANDARD CO., LTD.
All rights reserved

No portion of this manual
may be reproduced without
the permission of
VERTEX STANDARD CO., LTD.