

# YAESU

## STATION MONITOR

# SM-5000

# OPERATING MANUAL

Thank you for your purchase. The **SM-5000** Station Monitor provides a visual display of the VFO-A band spectrum. Both strong and weak signals are clearly depicted. The integrated stereo speakers provide comfortable receiver audio.

### ! SAFETY INFORMATION !

- Do not modify this equipment.
- Do not place this equipment in a location exposed to dust and/or high humidity.
- Do not expose the **SM-5000** Station Monitor to direct sunlight or excessive temperatures.

## INSTALLATION

Before installing the **SM-5000**, turn off the Main Power Switch on the rear panel of the **FTdx5000**.

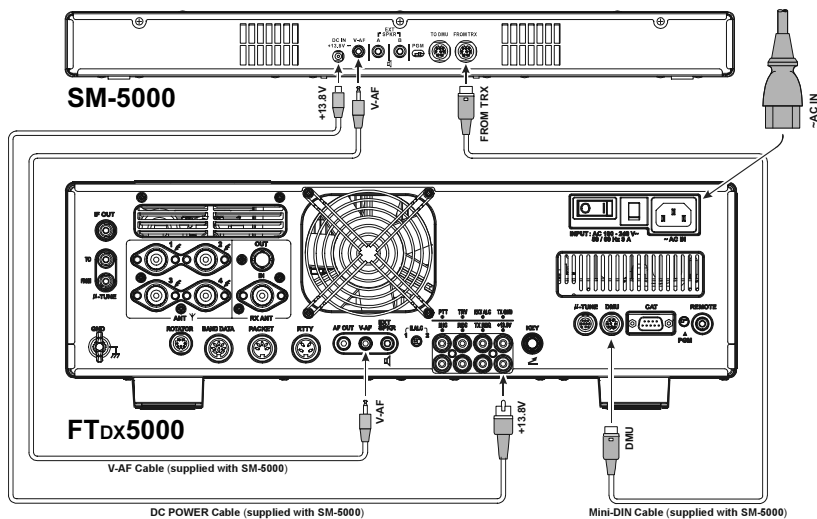

### SIDE PLATE INSTALLATION

If the **SM-5000** will be placed on top of the **FTdx5000**, attach the supplied Side Plates on both sides of the **SM-5000** with the supplied screws.

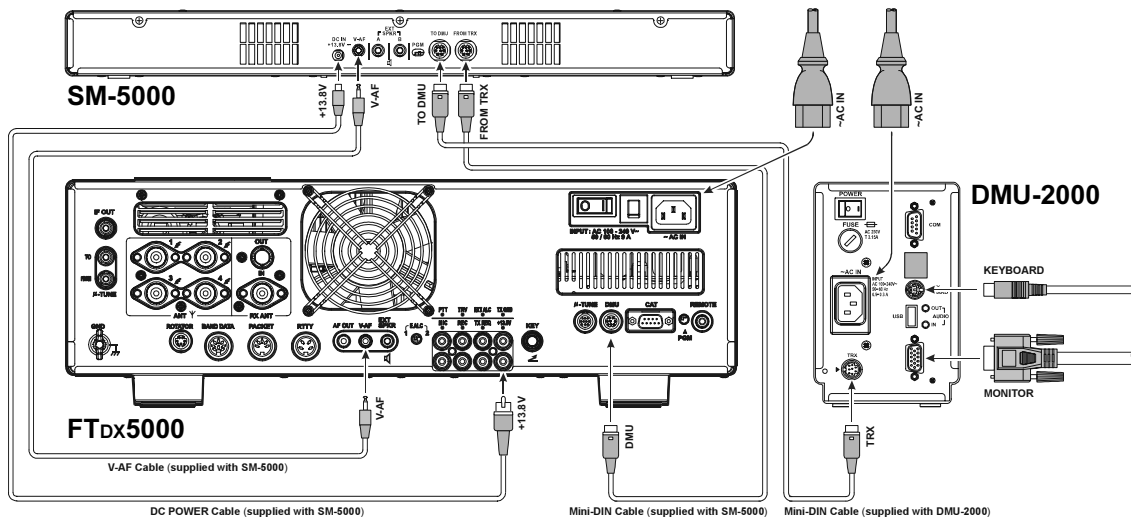
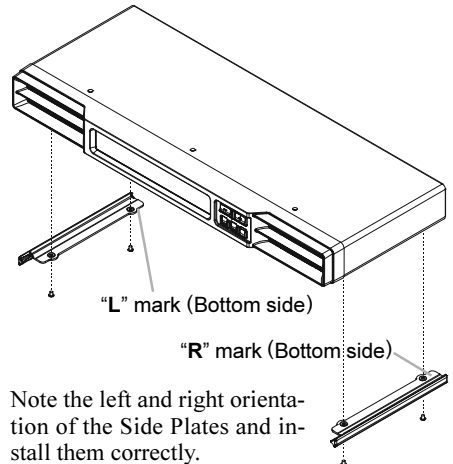

## FRONT PANEL SWITCHES

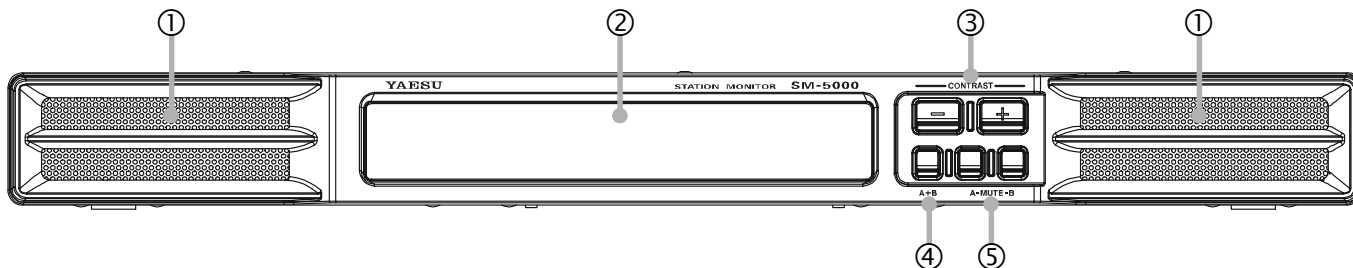

### ① Speaker

Dual 2.6" x 1" (65 x 25 mm) oval speakers direct the sound toward the front. The audio response is specially tailored for shortwave reception.

Independent Left or Right mute capability is provided for VFO-A and VFO-B on the Station Monitor, without changing any settings on the transceiver.

### ② Display

This LCD Monitor displays the Spectrum Scope of VFO-A band activity.

### ③ [CONTRAST][+] / [-] Switch

These switches are used for adjustment of the LCD Contrast Setting and the Audio Setting.

Press both switches simultaneously, to toggle the adjustment mode between "LCD Contrast Setting" and "Audio Setting".

Refer to page 6 for the details of the "Audio Setting", and refer to page 7 for the details of the "LCD Contrast Setting".

### ④ [A+B] Switch

Selects the speaker output mode during Dual Receive operation.

When this switch is un-pressed (■), the left speaker produces audio from the VFO-A receiver, while the right speaker produces audio from VFO-B receiver.

When this switch is depressed (■), mixed audio from the VFO-A and VFO-B receivers is produced by both speakers.

#### NOTE:

1) Requires **FTdx5000** Menu item "108 ROUT HEADPHN" be set to "SEPARATE".

2) When receiving only VFO-A or VFO-B, the audio is routed to both speakers, regardless of the switch position.

### ⑤ [MUTE-A] / [MUTE-B] Switches

The [MUTE-A] switch allows you to mute the audio from the VFO-A receiver. Similarly, the [MUTE-B] switch allows you to mute the audio from the VFO-B receiver.

This can be particularly useful during Dual Receive operation, when you want to concentrate on just one receiver for a moment.

## REAR PANEL CONNECTIONS

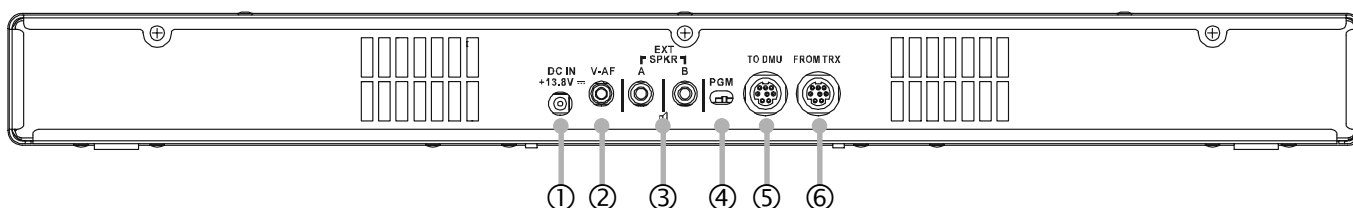

### ① DC IN +13.8V Jack

Connect the supplied DC cable between this jack and +13.8V jack on the **FTdx5000** transceiver.

### ② V-AF Jack

Connect the supplied connection cable between this jack and V-AF jack on the **FTdx5000** transceiver.

### ③ EXT SPKR Jacks

Connect the external speakers to these jacks, if desired. Inserting a plug into the **A** jack disables the left side speaker of the **SM-5000**. Similarly, inserting a plug into the **B** jack disables the right side speaker of the **SM-5000**.

### ④ [PGM] Switch

This slide switch is used for updating the **SM-5000** firmware. The update software and instructions are available for download from the Vertex Standard website (<http://www.yaesu.com/>).

### ⑤ TO DMU Jack

To use the optional **DMU-2000** Data Management Unit at the same time, connect the cable supplied with the **DMU-2000** between this jack and the **TRX** jack on the **DMU-2000**.

### ⑥ FROM TRX Jack

Connect the supplied control cable between this jack and the **DMU** jack on the **FTdx5000** transceiver.

## ABOUT THE SPECTRUM SCOPE

The **SM-5000** Spectrum Scope provides a visual display of an amateur band segment tuned by the VFO-A receiver. The default bandwidth allows you to see both strong and weak signals clearly depicted on the monitor screen. During transmission, the transmitter's waveform will be displayed, except when the frequency span is set to 2500 kHz in the CTR (Center) display mode or set to 1000/2500 kHz in the FIX (Fixed) display mode.

The LBWS (Limited Band Width Sweep) function provides very high-speed signal detection over a limited segment of the currently displayed spectrum. The CTR (Center) display mode will let you monitor signals close to your current frequency (your frequency is located at the center of the screen). When the FIX (fixed) mode is engaged, the left band edge frequency is fixed, and your operating frequency may be indicated within the displayed bandwidth. These features have been carefully considered for their utility in actual Amateur Radio operation.

**Note:** The vertical axis of the Spectrum Scope display is approximately 10 dB per division.

## USING THE CTR (CENTER) DISPLAY MODE

In the CTR mode, the operating frequency is shown at the center of the monitor screen. The selected Spectrum Scope frequency bandwidth is displayed across the monitor screen. Signals received on the VFO-A band are shown. (To show signals more clearly and easily, the LBWS (Limited Band Width Sweep) function lets you perform a high-speed, high-resolution sweep of a limited band segment (See page 4 for details).

1. Press and hold the **FTdx5000 [C.S]** key for 2 seconds to engage the Scope Menu mode.  
The **SUB DISPLAY-I** window will show the Group name (SCOPE), while the **SUB DISPLAY-II** window will show the Menu item. The **SUB DISPLAY-III** window shows the setting of the currently-selected Menu item.
2. Rotate the **(VFO-A)[SELECT]** knob to select the Menu item "MODE".
3. Rotate the **(VFO-B)[SELECT]** knob to select "CENTER".  
The current VFO-A frequency is displayed at the center of the screen.
4. Rotate the **(VFO-A)[SELECT]** knob to select the Menu item "SPAN", then rotate the **(VFO-B)[SELECT]** knob to select the desired frequency span to monitor.  
Available selections are: 25 kHz, 50 kHz, 100 kHz, 250 kHz, 500 kHz, 1000 kHz, and 2500 kHz.
5. Rotate the **(VFO-A)[SELECT]** knob to select the Menu item "ATT", then rotate the **(VFO-B)[SELECT]** knob to select the display attenuation value according to current propagation conditions, your operating frequency, and antenna, etc.  
Available selections are: 0 dB, 10 dB, and 20 dB.
6. Press the **[C.S]** key briefly to save the new setting and exit to normal operation.

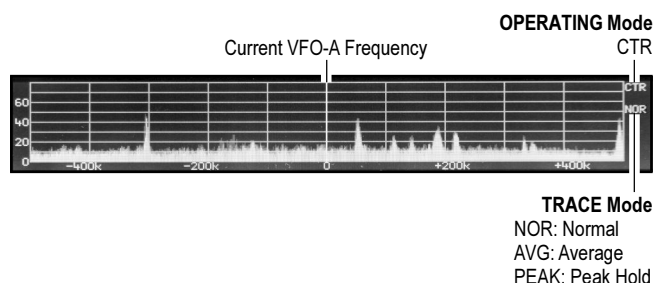
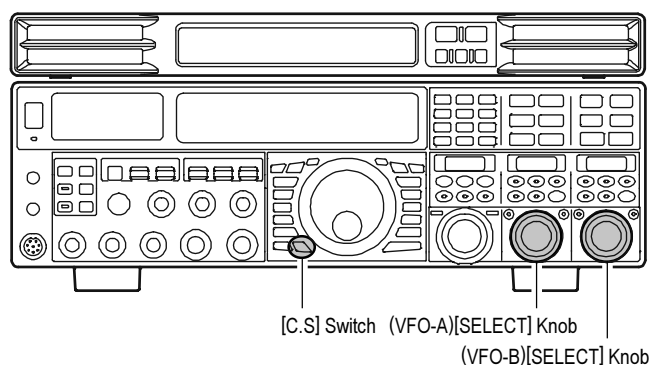

## CHANGING THE TRACE MODE

1. Press and hold the **FTdx5000 [C.S]** key for 2 seconds to engage the Scope Menu mode.  
The **SUB DISPLAY-I** window will show the Group name (SCOPE), while the **SUB DISPLAY-II** window will show the Menu item. The **SUB DISPLAY-III** window shows the setting of the currently-selected Menu item.
2. Rotate the **(VFO-A)[SELECT]** knob to select the Menu item "TRACE", then rotate the **(VFO-B)[SELECT]** knob to select the desired trace mode.  
Available selections are shown at the right.
3. Press the **[C.S]** key briefly to save the new setting and exit to normal operation.

**NORMAL:** The real-time signal strength will be displayed. Normally, you will want to use this mode.

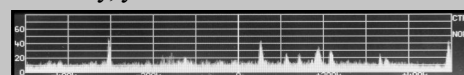

**AVERAGE:** The averaged signal strength will be displayed.

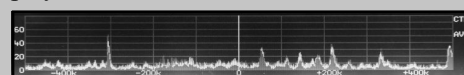

**PEAKHOLD:** The Peak signal level will be displayed and held until the frequency is changed.

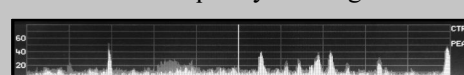

## USING THE LBWS (LIMITED BAND WIDTH SWEEP) FUNCTION

LBWS (Limited Band Width Sweep) is a function that sweeps a limited *segment* of the Spectrum Scope span without *changing* the span (bandwidth). As the sweep segment becomes narrower, the speed becomes faster, and the accuracy and resolution are enhanced.

The bandwidth can be set to 50 %, 30 %, or 10 % of the full span. The sweep speed will increase as follows: 50 %: about 2 times faster, 30 %: about 3 times faster, 10 %: about 10 times faster.

1. Press and hold the **FTdx5000 [C.S]** key for 2 seconds to engage the Scope Menu mode.

The **SUB DISPLAY-I** window will show the Group name (SCOPE), while the **SUB DISPLAY-II** window will show the Menu item. The **SUB DISPLAY-III** window shows the setting of the currently-selected Menu item.

2. Rotate the **(VFO-A)[SELECT]** knob to select the Menu item "MODE", then rotate the **(VFO-B)[SELECT]** knob to select the desired sweep bandwidth.

LBWS-1: The sweep speed becomes about 2 times faster (The bandwidth decreases to 50 %).

LBWS-2: The sweep speed becomes about 3 times faster (The bandwidth decreases to 30 %).

LBWS-3: The sweep speed becomes about 10 times faster (The bandwidth decreases to 10 %).

**Note:** The "CENTER" and "FIX" selections are not select items of the LBWS function. Do not select these selections.

4. Rotate the **(VFO-A)[SELECT]** knob to select the Menu item "SPAN", then rotate the **(VFO-B)[SELECT]** knob to select the desired frequency span to monitor.

Available selections are: 25 kHz, 50 kHz, 100 kHz, 250 kHz, 500 kHz, 1000 kHz, and 2500 kHz.

5. Rotate the **(VFO-A)[SELECT]** knob to select the Menu item "ATT", then rotate the **(VFO-B)[SELECT]** knob to select the display attenuation value according to current propagation conditions, your operating frequency, and antenna, etc. Available selections are: 0 dB, 10 dB, and 20 dB.

6. Press the **[C.S]** key briefly to save the new setting and exit to normal operation.

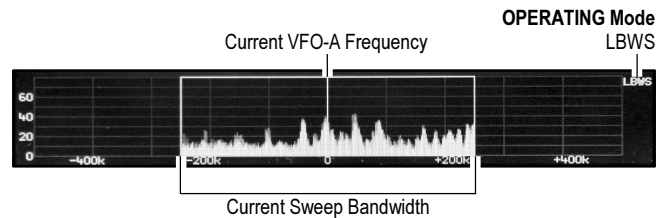
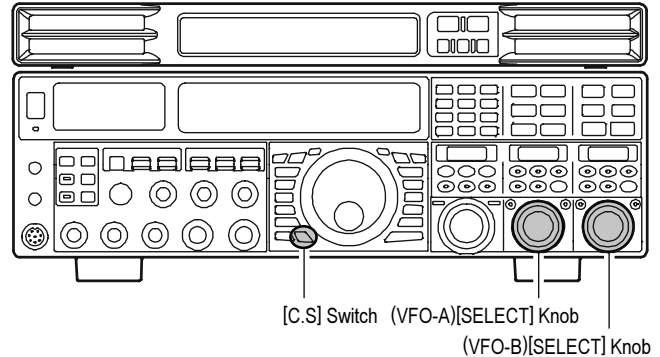

### NOTE:

The Trace Mode cannot be selected with the LBWS function.

### SELECTING THE SWEEP AREA

1. Press and hold the **FTdx5000 [C.S]** key for 2 seconds to engage the Scope Menu mode.

The **SUB DISPLAY-I** window will show the Group name (SCOPE), while the **SUB DISPLAY-II** window will show the Menu item. The **SUB DISPLAY-III** window shows the setting of the currently-selected Menu item.

2. Rotate the **(VFO-A)[SELECT]** knob to select the Menu item "LBWS", then rotate the **(VFO-B)[SELECT]** knob to select the desired sweep area. Available selections are shown at the right.

3. Press the **[C.S]** key briefly to save the new setting and exit to normal operation.

LBWSx L: The Spectrum scan sweeps the band segment on the lower side of the operating frequency.

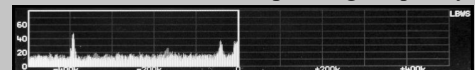

LBWSx M: The Spectrum scan sweeps the band segment centered on the operating frequency.

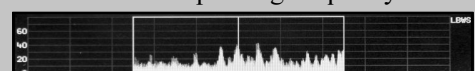

LBWSx H: The Spectrum scan sweeps the band segment on the upper side of the operating frequency.



x: 1, 2, or 3; indicates the sweep segment that is designated in the Menu item "MODE", described previously. The above examples are "2" (LBWS-2).

---

---

## USING THE FIX (FIXED) MODE

---

---

The FIX mode is convenient when you want to monitor an entire amateur band.

The starting point, located at the left edge of the screen, can be set for each amateur band via **FTdx5000** Menu items (“131 SCP 1.8 FIX” ~ 141 SCP 50.0 FIX”). Even if the screen span (bandwidth) is changed, the start frequency will *not* be changed. By watching the screen, you can move your operation to a clear channel or find frequencies where interesting activity appears on the display.

1. Press and hold the **FTdx5000 [C.S]** key for 2 seconds to engage the Scope Menu mode.  
The **SUB DISPLAY-I** window will show the Group name (SCOPE), while the **SUB DISPLAY-II** window will show the Menu item. The **SUB DISPLAY-III** window shows the setting of the currently-selected Menu item.
2. Rotate the **(VFO-A)[SELECT]** knob to select the Menu item “MODE”.
3. Rotate the **(VFO-B)[SELECT]** knob to select “FIX”.  
The current VFO-A frequency is indicated on the screen by a bold vertical line, for ease of status recognition.
4. Rotate the **(VFO-A)[SELECT]** knob to select the Menu item “SPAN”, then rotate the **(VFO-B)[SELECT]** knob to select the desired frequency span to monitor.  
Available selections are: 25 kHz, 50 kHz, 100 kHz, 250 kHz, 500 kHz, 1000 kHz, and 2500 kHz.
5. Rotate the **(VFO-A)[SELECT]** knob to select the Menu item “ATT”, then rotate the **(VFO-B)[SELECT]** knob to select the display attenuation value according to current propagation conditions, your operating frequency, and antenna, etc.  
Available selections are: 0 dB, 10 dB, and 20 dB.
6. Press the **[C.S]** key briefly to save the new setting and exit to normal operation.

### ADVICE:

If the VFO-A frequency is outside of the spectrum shown on the screen, the operating frequency will be "shown" in the lower area of the display as “<<<” or “>>>”.

### NOTE:

When using the FIX (Fixed) Mode, the PEAK (Peak Hold) Display does not refresh when changing the frequency. Return to CTR (Center) Display Mode to refresh the display.

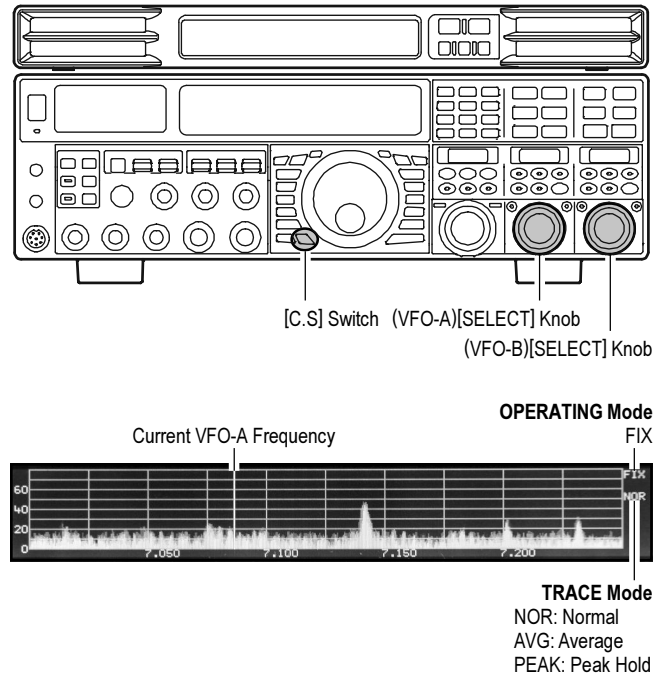

## AUDIO SETTING

### AUDIO MUTING

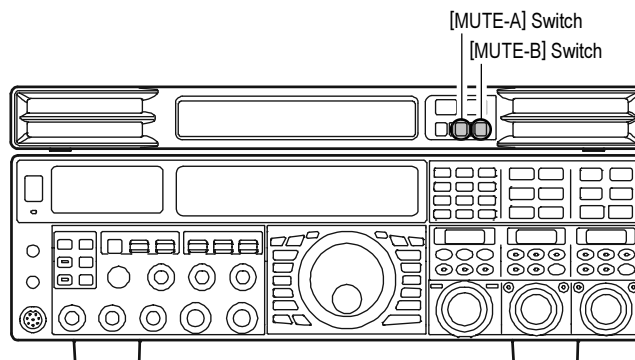

The Audio Mute feature be particularly useful during Dual Receive operation, when you want to concentrate on just one receiver for a moment.

- Press the **[MUTE-A]** switch to toggle the VFO-A receiver audio “on” and “off”.
- Press the **[MUTE-B]** switch to toggle the VFO-B receive audio “on” and “off”.



### AUDIO MIXING

The Audio Mixing feature combines the left and right speakers to project excellent fidelity audio across a broad listening area.

- When the **[A+B]** switch is depressed (  ), mixed audio from VFO-A and VFO-B receivers is produced from both speakers, creating excellent fidelity audio in a wide range.
- When the **[A+B]** switch is un-pressed (  ), the left speaker produces audio from VFO-A receiver, while the right speaker produces audio from VFO-B receiver.

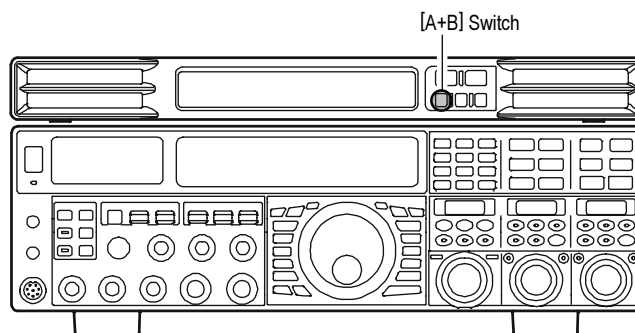

### SOUND QUALITY

You may control the received audio with four additional choices:

1. If needed, press both **[CONTRAST(+)]** and **[CONTRAST(-)]** switches to change the adjustment mode to “Audio Setting”.

The Audio Setting window will appear on the display.

**Note:** Pressing of the **[CONTRAST(+)]/[CONTRAST(-)]** switch will store the last selected “Contrast Setting Mode” or “Audio Setting Mode” to memory.

2. Press the **[CONTRAST(-)]** switch repeatedly to choose the desired audio response. Available selections are:

**CLEAR:** High Fidelity receiver audio, full quality, clear, readable sound.

**MILD:** The high pitch tones of the receiver audio are reduced, without changing the low base sound quality.

**SOFT:** The low frequency base range of the receiver audio is boosted and the high pitch tones are reduced.

**LOUDNESS:** The low frequency base range of the received audio is boosted while preserving clear sound quality, with high readability.

3. A few seconds after pressing the **[CONTRAST(-)]** switch, the Audio Setting window will close.

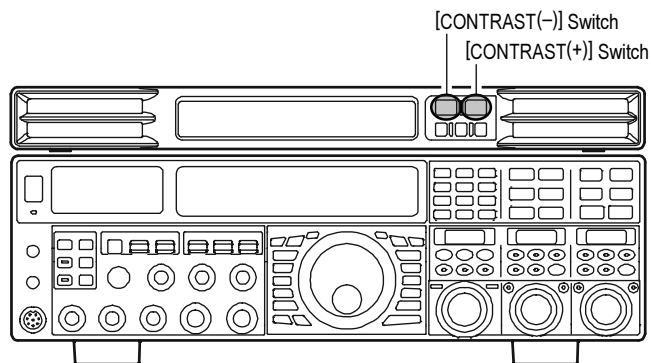

---

---

## AUDIO SETTING

---

---

### PHASE INVERSION

When the received audio phase is reversed, the **SM-5000** gives depth to the audio sound.

1. If needed, press both [**CONTRAST(+)**] and [**CONTRAST(-)**] switches to change the adjustment mode to “Audio Setting”.  
The Audio Setting window will appear on the display.  
*Note:* Pressing of the [**CONTRAST(+)**]/[**CONTRAST(-)**] switch will store the last selected “Contrast Setting Mode” or “Audio Setting Mode” to memory.
2. Press the [**CONTRAST(+)**] switch to toggle the audio phase “ON (reversed phase)” or “OFF (normal response)”.
3. A few seconds after pressing the [**CONTRAST(+)**] switch, the Audio Setting window will close.

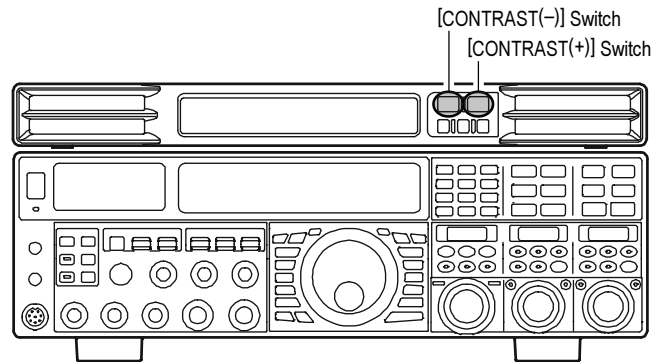

---

---

## DISPLAY SETTING

---

---

### ADJUSTING THE CONTRAST

You may adjust the contrast for best viewing in sunlight, dusk, or night allowing for best readability.

1. If needed, press both [**CONTRAST(+)**] and [**CONTRAST(-)**] switches to change the adjustment mode to “LCD Contrast Setting”.  
The Contrast window will appear on the display.  
*Note:* Pressing of the [**CONTRAST(+)**]/[**CONTRAST(-)**] switch will store the last selected “Contrast Setting Mode” or “Audio Setting Mode” to memory.
2. Press the [**CONTRAST(+)**] switch to increase the contrast of the display.
3. Press the [**CONTRAST(-)**] switch to reduce the contrast of the display.
4. A few seconds after pressing the [**CONTRAST(+)**]/[**CONTRAST(-)**] switch, the Contrast window will close.

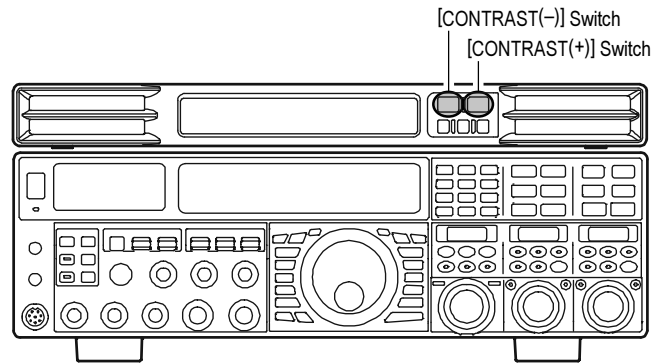

#### ADVICE:

When a contrast level is too high, it is difficult to watch the “Average” and “Peak hold” indication (See page 3).

### SPECTRUM SCOPE DISPLAY “ON/OFF”

You may turn off the Spectrum Scope Display.

1. Press and hold the **FTDx5000** [**C.S**] key for 2 seconds to engage the Scope Menu mode.  
The **SUB DISPLAY-I** window will show the Group name (SCOPE), while the **SUB DISPLAY-II** window will show the Menu item. The **SUB DISPLAY-III** window shows the current setting of the currently-selected Menu item.
2. Rotate the (**VFO-A**)[**SELECT**] knob to select the Menu item “DISPLAY”, then rotate the (**VFO-B**)[**SELECT**] knob to select “OFF”.  
The Spectrum Scope Display turns off.
3. Press the [**C.S**] key briefly to save the new setting and exit to normal operation.

To turn the Spectrum Scope Display on, repeat the above procedure, rotating the (**VFO-B**)[**SELECT**] knob to select “ON” as in step “2” above.

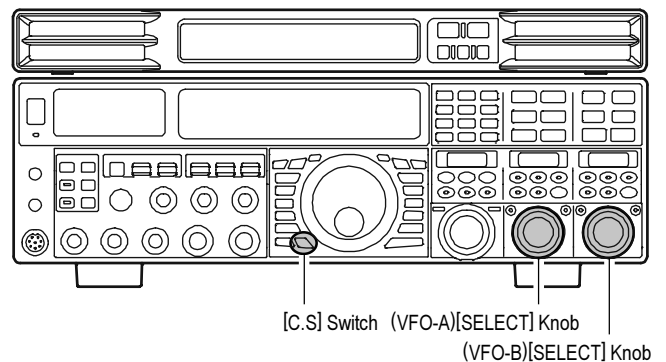

### DISPLAY DIMMER

When the **FTDx5000** [**DIM**] button is pressed, the illumination level of the **SM-5000** will also be reduced.

The amount of brightness may be set via **FTDx5000** Menu item “011 DISP DIM ELCD”.

---

---

## SUPPLIED OPTION

---

---

DC POWER Cable (USA/EXP version: T9101593) .....	1
(European version: T9101596) .....	1
Mini-DIN Cable (USA/EXP version: T9101526) .....	1
(European version: T9101594) .....	1
V-AF Cable (T9101595) .....	1
Side Plate-L (RA1227300 + RA1231900) .....	1
Side Plate-R (RA1227400 + RA1231900) .....	1
Screw (M3x4: U9900264) .....	4
Operating Manual .....	1

---

---

## RESETTING THE MICROPROCESSOR

---

---

Press and hold the [**CONTRAST(+)**] and [**CONTRAST(-)**] switches while turning the **FTDx5000** transceiver on to reset the Sound Quality, Phase Inversion, and Contrast settings to their factory default.

---

---

## SPECIFICATIONS

---

---

**Input Voltage:** 13.8 VDC, 1 A (max); Supplied from FTDx5000 Transceiver  
**Operating Temperature Range:** +14 °F to +122 °F (-10 °C to +50 °C)  
**Speaker Aperture:** 2.6" x 1" (65 x 25 mm); Left and right speakers are identical  
**Maximum Audio Output:** 1.5 W + 1.5 W (@8 Ω)  
**Case Size (WxHxD):** 18" x 1.8" x 7.1" (462 x 45 x 181 mm)  
**Weight (Approx.):** 5.5 lbs (2.5 kg)

**VERTEX STANDARD CO., LTD.**  
4-8-8 Nakameguro, Meguro-Ku, Tokyo 153-8644, Japan

**VERTEX STANDARD**  
**US Headquarters**  
10900 Walker Street, Cypress, CA 90630, U.S.A.

**YAESU UK LTD.**  
Unit 12, Sun Valley Business Park, Winnall Close  
Winchester, Hampshire, SO23 0LB, U.K.

**VERTEX STANDARD HK LTD.**  
Unit 1306-1308, 13F., Millennium City 2, 378 Kwun Tong Road,  
Kwun Tong, Kowloon, Hong Kong

**VERTEX STANDARD (AUSTRALIA) PTY., LTD.**  
Tally Ho Business Park, 10 Wesley Court, East Burwood, VIC, 3151



Copyright 2011  
VERTEX STANDARD CO., LTD.  
All rights reserved  
No portion of this manual  
may be reproduced without  
the permission of  
VERTEX STANDARD CO., LTD.

Printed in Japan.

