

# FT-11R

## TECHNICAL SUPPLEMENT



**YAESU MUSEN CO., LTD.**

C.P.O. Box 1500, Tokyo, Japan

**YAESU U.S.A.**

17210 Edwards Rd., Cerritos, California  
90701, U.S.A.

**YAESU EUROPE B.V.**

Snipweg 3. 1118AA Schipol, The Netherlands

# Contents

Introduction . . . . .	1-1
Chip Component Information . . . . .	1-2
Transceiver Disassembly and PCB Access . . . . .	2-1
Exploded View & Miscellaneous Parts . . . . .	2-3
Alignment . . . . .	2-5
Circuit Description . . . . .	3-1
Block Diagram . . . . .	3-5
Interconnection Diagram . . . . .	3-6
<b>Board Unit (Schematics, Layout &amp; Parts)</b>	
Mother Unit . . . . .	4A-1
CNTL Unit . . . . .	4B-1
AF Unit . . . . .	4C-1
SW Unit . . . . .	4D
CONTACT Unit . . . . .	4E
VCO Unit . . . . .	4F
KEYBOARD Unit . . . . .	4G
<b>Optional Board Unit (Schematics, Layouts &amp; Parts)</b>	
FTS-26 CTCSS . . . . .	5-1

Cut out the label at the right and place it behind the clear plastic window in the spine of the manual binder.

**FT - 11R**  
Technical Supplement



The information in this manual is intended to supplement the FT-11R Operating Manual, for servicing the transceiver. Specifications and details of operation and options are provided in the operating manual, and are not reprinted herein. Therefore, the manual is not intended to serve as an independent reference, but to be used in conjunction with the information provided in the operating manual. The FT-11R is intended to be serviced only by qualified technicians.

Two PCB layout diagrams are provided for each double-sided circuit board in the transceiver. Each side of the board is referred to by the type of the majority of components installed on that side ("leaded" or "chip-only"). In most cases one side has only chip components, and the other has either a mixture of both chip and leaded components (trimmers,

coils, electrolytic capacitors, ICs, etc.), or leaded components only.

While we believe the technical information in this manual is correct, Yaesu cannot assume liability for any damage that may occur as a result of typographical or other errors that may be present. Your cooperation in pointing out any inconsistencies in the technical information would be appreciated.

The technical information on this manual supersedes all previously published information on this product. Where information is duplicated in this manual and the operating manual, this manual should generally be considered more current.

Yaesu Musen reserves the right to make changes in the circuitry of this transceiver, in the interest of technological improvement, without obligation to owners.

# Chip Component Information

## Chip Component Information

The diagrams below indicate some of the distinguishing features of common chip components.

### Ceramic Capacitors

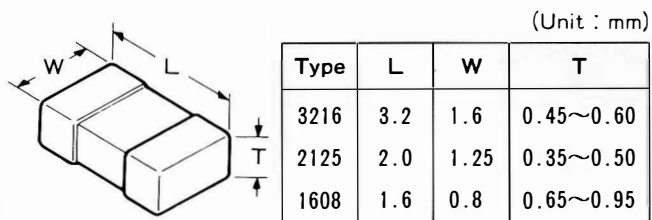

Type	L	W	T
3216	3.2	1.6	0.45~0.60
2125	2.0	1.25	0.35~0.50
1608	1.6	0.8	0.65~0.95

### Tantalum Capacitors

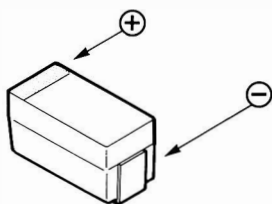

Type RMC 1/10W, 1/16W

Marking\* 100,222,473.....

473		
Ten unit	One unit	Multiplier code
0	0	10 <sup>0</sup>
1	1	10 <sup>1</sup>
2	2	10 <sup>2</sup>
3	3	10 <sup>3</sup>
4	4	10 <sup>4</sup>
5	5	10 <sup>5</sup>
6	6	10 <sup>6</sup>
7	7	10 <sup>7</sup>
8	8	10 <sup>8</sup>
9	9	10 <sup>9</sup>

Examples :

$$100 = 10\Omega$$

$$222 = 2.2k\Omega$$

$$473 = 47k\Omega$$

### Resistors

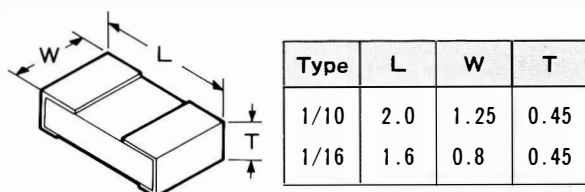

Type	L	W	T
1/10	2.0	1.25	0.45
1/16	1.6	0.8	0.45

### Indicated Letters

**1 2 3 4**

**5 6 7 8**

**9 0 .**

---

# Chip Component Information

## Replacing Chip Components

Chip components are installed at the factory by a series of robots. The first one places a spot of adhesive resin at the location where each part is to be installed, and later robots handle and place parts using vacuum suction.

For single-sided boards, solder paste is applied and the board is then baked to harden the resin and flow the solder. For double-sided boards, no solder paste is applied, but the board is baked (or exposed to ultra-violet) to cure the resin before dip soldering.

In our laboratories and service shops, small quantities of chip components are mounted manually by applying a spot of resin, placing with tweezers, and then soldering by very small dual streams of hot air (without physical contact during soldering). We remove parts by first removing solder using a vacuum suction iron, which applies a light, steady vacuum at the iron tip, and then breaking the adhesive with tweezers.

The special vacuum soldering/desoldering equipment is recommended if you expect to do a lot of chip replacements. Otherwise, it is usually possible to remove and replace chip components with only a tapered, temperature-controlled soldering iron, a set of tweezers and braided copper solder wick. Soldering iron temperature should be less than 280 °C (536 °F).

## Precautions for Chip Replacement

- ✗ Do not disconnect a chip forcefully, or the foil pattern may peel off the board.
- ✗ Never re-use a chip component. Dispose of all removed chip components immediately to avoid mixing with new parts.
- ✗ Limit soldering time to 3 seconds or less to avoid damaging the component and board.

## Removing Chip Components

- Remove the solder at each joint, one joint at a time, using solder wick whetted with non-acidic flux as shown below. Avoid applying pressure, and do not attempt to remove the tinning from the chip's electrode.

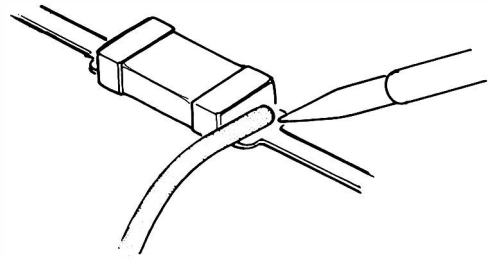

- Grasp the chip on both sides with tweezers, and gently twist the tweezers back and forth (to break the adhesive bond) while alternately heating each electrode. Be careful to avoid peeling the foil traces from the board. Dispose of the chip when removed.

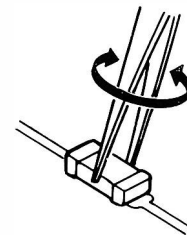

- After removing the chip, use the copper braid and soldering iron to which away any excess solder and smooth the land for installation of the replacement part.

# Chip Component Information

---

## *Installing a Replacement Chip*

As the value of some chip components is not indicated on the body of the chip, be careful to get the right part for replacement.

- Apply a small amount of solder to the land on one side where the chip is to be installed. Avoid using too much solder, which may cause bridging (shorting to other parts).

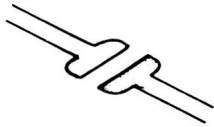

- Hold the chip with tweezers in the desired position, and apply the soldering iron with a motion line that is indicated by the arrow in the diagram below. Do not apply heat for more than 3 seconds.

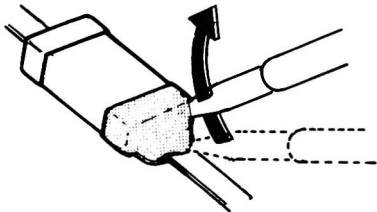

- Remove the tweezers and solder the electrode on the other side in the manner just described.

# Transceiver Disassembly and PCB Access

## CNTL & AF Unit Removal

Before beginning, turn the radio off, remove the soft case, if used, and the battery pack. During the disassembly procedure, be careful not to mix removed screws (some are similar in size, but have different types of threading/pitch).

- Lay the transceiver on a flat surface covered with a soft cloth to protect the front case from marring, and remove the six rear-panel case screws (Fig. 1).

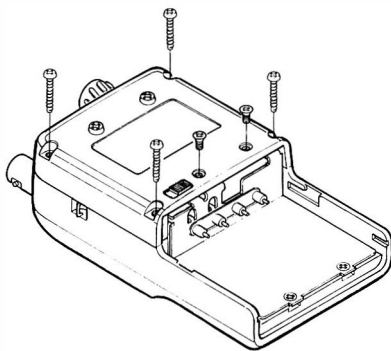

Figure 1.

- Next, carefully separate the front and rear transceiver halves, being careful not to lose the case-mounted swivel and battery release slide.
- Disconnect the flat ribbon cable from its connector on the AF Unit by using two fingertips to slide out the cable release, then unplug the 3-pin connector from the Mother Unit, as shown in Fig. 2.

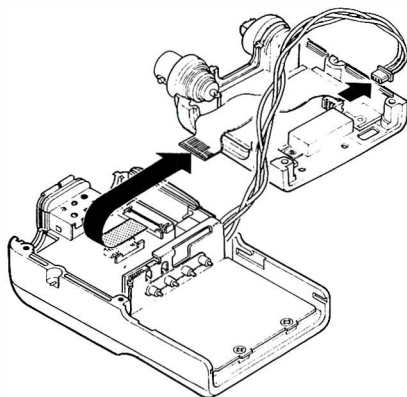

Figure 2.

- Referring to Fig. 3, remove the two screws from the metal Sub-Panel, and lift the unit out and set it aside.
- Remove two screws from the AF Unit PCB, then slowly and carefully lift up the AF Unit to free it from the two connectors that mate it to the CNTL Unit beneath. Note that the CNTL Unit is connected to the Keyboard Unit by a flat ribbon cable and connector.

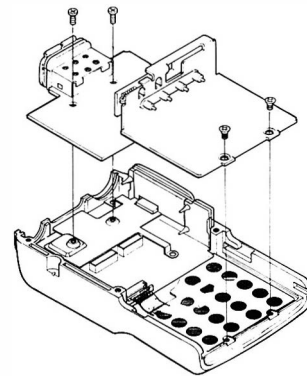

Figure 3.

- Referring to Fig. 4, remove the two screws from the metal frame, and the screw affixing the flexible metal spring plate at the upper-right corner. Lift the CNTL Unit (along with the Keyboard Unit) from the front case. To remove the Keyboard Unit, use a small screwdriver to slide the cable release outward to free the ribbon cable. Then separate the Keyboard Unit from the CNTL Unit.

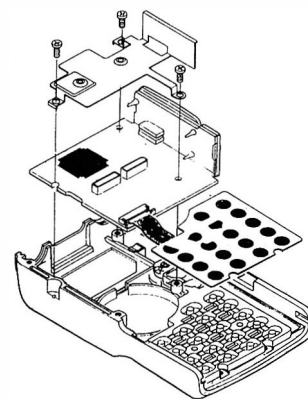

Figure 4.

# Transceiver Disassembly and PCB Access

## Mother Unit Removal

- Remove the top panel DIAL selector knob and antenna gasket, as shown below, then remove the locking nuts from the BNC jack and rotary switch. Use a tool designed for this purpose, or a pair of needle nose pliers (take care not to damage the threads), see Fig. 5 below.

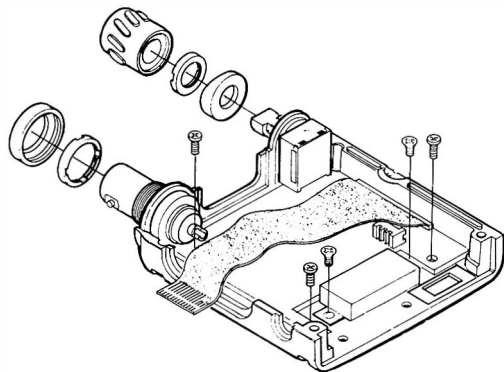

Figure 5.

- Next remove three screws from the Mother Unit, and two from the RF Power Amplifier Module, as shown above.
- Unsolder the antenna lead from the BNC jack center conductor, and the ground tab from the base (see Fig. 6). Slide the Mother Unit out from rear case, being careful with the RF Power Module leads

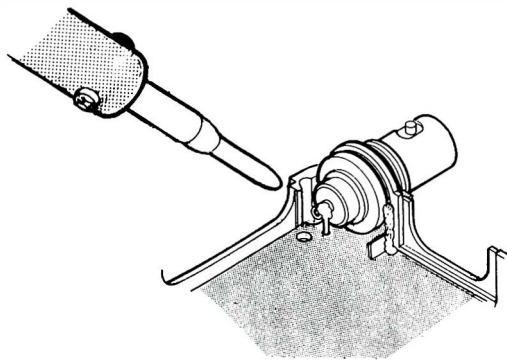

Figure 6.

- The Sub-Panel Unit also contains the Contact Unit, which makes electrical connection with the battery pack using 4 spring-loaded pins. To separate the Contact Unit, use an iron and desoldering braid or vacuum-type suction unit to desolder the 4 pin connections on the PCB (Fig. 7). The Contact Unit can then be removed from the Sub Panel.

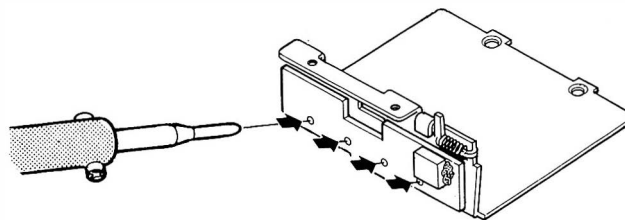

Figure 7.

- This completes the disassembly procedure, reassemble all units in the reverse manner, paying attention to screw type and location. With the CNTL and Keyboard Units removed, the translucent keyboard membrane can be popped out for replacement if needed.

*Be sure to keep the rubber gasket around the AF Unit **MIC & EAR** jack, and to carefully align it with case cut-out when reinstalling the AF Unit into the case.*



# Exploded View & Miscellaneous Parts

REF.	YAESU P/N	Description	Qty.
①	U07240101	PAN HEAD SCREW M2×4 #1	2
②	U20203027	BANDING HEAD SCREW M2.6×3B SUS	2
③	U9900040	TAPTITE SCREW M2×12.5B SUS	4
④	S5000102	TAPTITE SCREW B M2×4	8
⑤	U9900046	TAPTITE SCREW M2×4NI #1	2
⑥	U32240127	FLAT HEAD SCREW M2×4B SUS #1	2

Non-designated parts are available only as part of a designated assembly.

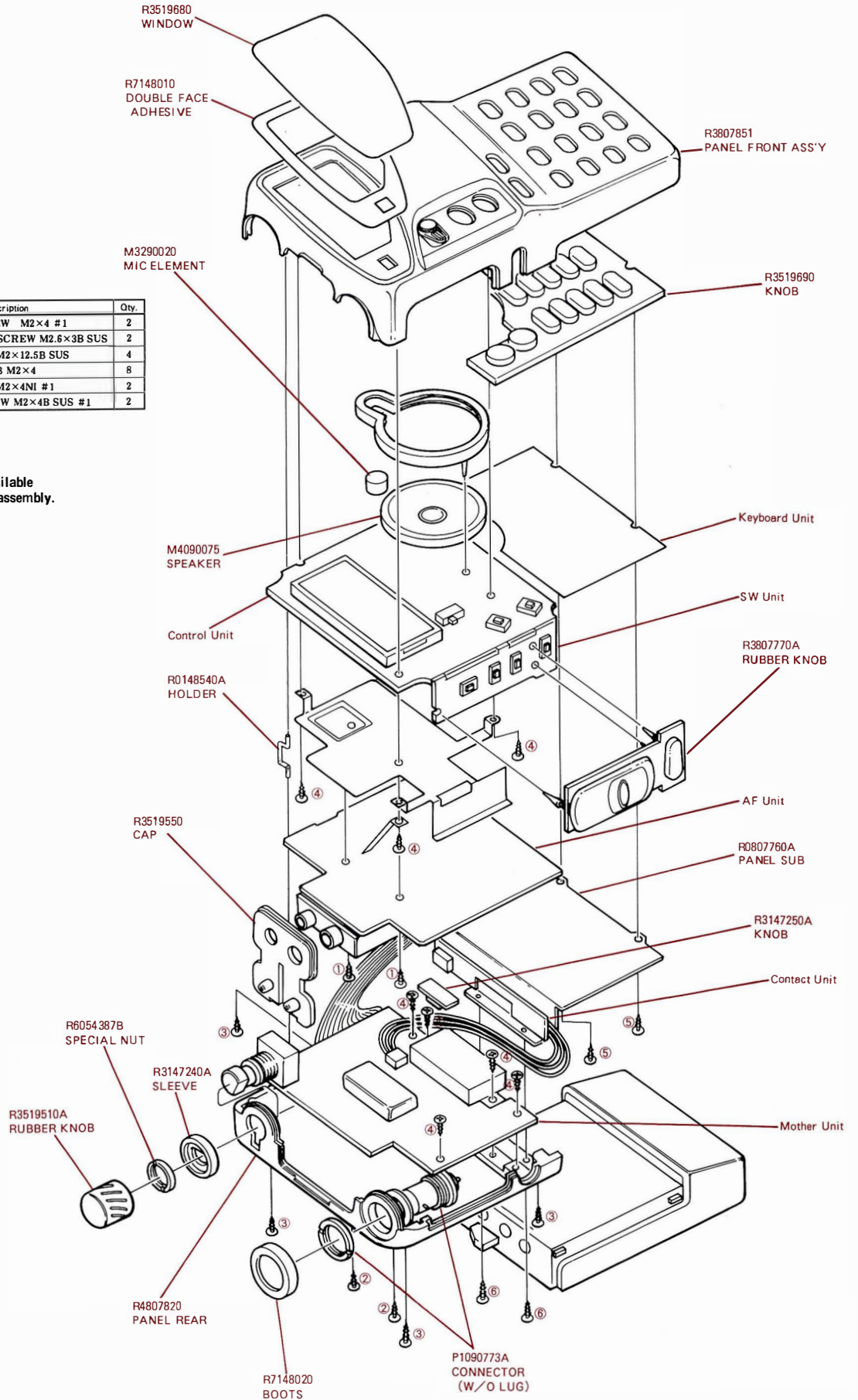



The FT-11R is carefully aligned at the factory for the specified performance across the amateur band. Realignment should therefore not be necessary except in the event of a component failure. All component replacement and service should be performed only by an authorized Yaesu representative, or the warranty policy may be void.

The following procedures cover the sometimes critical and tedious adjustments that are not normally required once the transceiver has left the factory. However, if damage occurs and some parts subsequently are replaced, realignment may be required. If a sudden problem occurs during normal operation, it is likely due to component failure; realignment should not be done until after the faulty component has been replaced.

We recommend that servicing be performed only by authorized Yaesu service technicians who are experienced with the circuitry and fully equipped for repair and alignment. Therefore, if a fault is suspected, contact the dealer from whom the transceiver was purchased for instructions regarding repair. Authorized Yaesu service technicians realign all circuits and make complete performance checks to ensure compliance with factory specifications after replacing any faulty components.

Those who do undertake any of the following alignments are cautioned to proceed at their own risk. Problems caused by unauthorized attempts at realignment are not covered by the warranty policy. Also, Yaesu reserves the right to change circuits and alignment procedures in the interest of improved performance, without notifying owners.

Under no circumstances should any alignment be attempted unless the normal function and operation of the transceiver are clearly understood, the cause of the malfunction has been clearly pinpointed and any faulty components replaced, and realignment determined to be absolutely necessary.

The following test equipment (and thorough familiarity with its correct use) is necessary for complete realignment. Correction of problems caused by misalignment resulting

from use of improper test equipment is not covered under the warranty policy. While most steps do not require all of the equipment listed, the interactions of some adjustments may require that more complex adjustments be performed afterwards. Do not attempt to perform only a single step unless it is clearly isolated electrically from all other steps. Have all test equipment ready before beginning, and follow all of the steps in a section in the order presented.

### *Required Test Equipment*

- RF Signal Generator with calibrated output level at 200 MHz
- Deviation Meter (linear detector)
- Oscilloscope
- AF Millivoltmeter
- SINAD Meter
- In-line Wattmeter with 5% accuracy at 200 MHz
- Regulated DC Power Supply adjustable from 3 to 12 VDC, 2A
- Frequency Counter: 0.2 ppm accuracy at 200 MHz
- AF Signal Generator
- DC Voltmeter: high impedance
- DC Ammeter 3 A
- Spectrum Analyzer
- VHF Sampling Coupler

### *Alignment Preparation & Precautions*

A 50- $\Omega$  dummy load and in-line wattmeter must be connected to the main antenna jack in all procedures that call for transmission, except where specified otherwise. Correct alignment is not possible with an antenna.

After completing one step, read the following step to determine whether the same test equipment will be required. If not, remove the test equipment (except dummy load and wattmeter, if connected) before proceeding.

# Alignment

Correct alignment requires that the ambient temperature be the same as that of the transceiver and test equipment, and that this temperature be held constant between 20° and 30°C (68° - 86°F). When the transceiver is brought into the shop from hot or cold air, it should be allowed some time to come to room temperature before alignment.

Whenever possible, alignments should be made with oscillator shields and circuit boards firmly affixed in place. Also, the test equipment must be thoroughly warmed up before beginning.

*Note: Signal levels in dB referred to in the alignment procedure are based on 0 dBμ = 0.5 μV.*

## PLL & Transmitter

Set up the test equipment as shown for transmitter alignment. Maintain the supply voltage at 11 VDC for all step. Connect the power supply leads to the transceiver terminals as shown in the drawing below.

### PLL Reference Frequency

- With the wattmeter, dummy load and frequency counter connected to the antenna jack, and while tuned to 146.000 MHz, key the transmitter and adjust TC1001 on the Mother Unit, if necessary, so the counter frequency is within 100 Hz of 146.000 MHz.

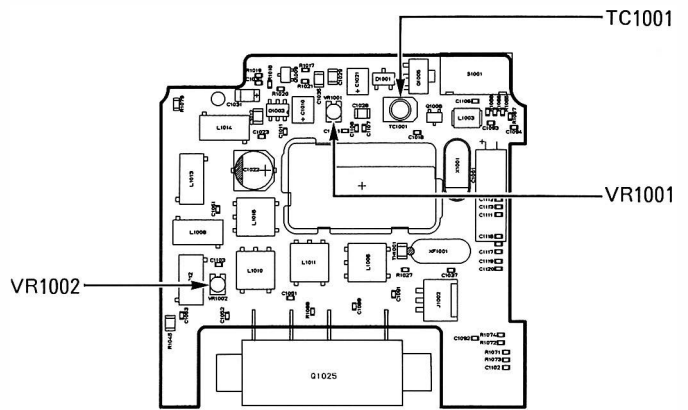
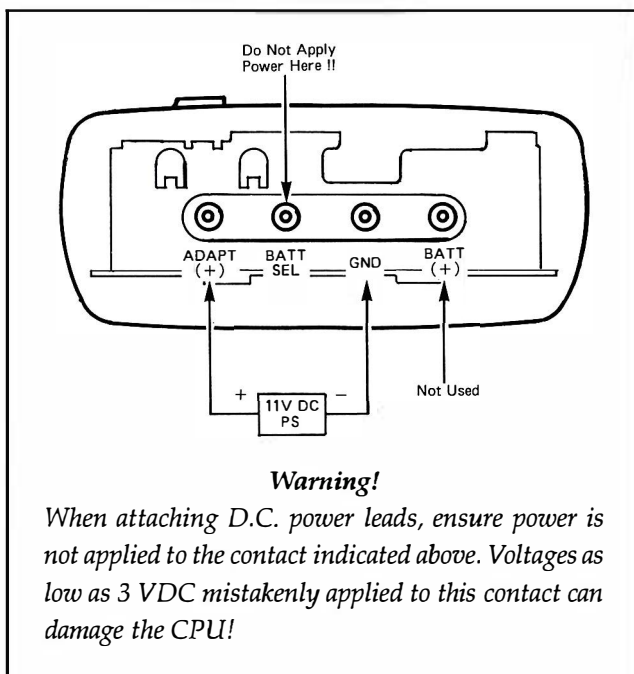

**Mother Unit TX Alignment Points**

### Transmitter Deviation

- While tuned to 146.000 MHz, adjust the AF generator attenuator for 25 mV<sub>rms</sub> output at 1 kHz to the **MIC** jack. Key the transmitter and adjust VR1001 on the Mother Unit for ±4.5kHz deviation on the deviation meter (within 100Hz).

### Transmitter Power Adjustment

- Connect the 50-Ω dummy load and inline wattmeter to the antenna jack. Tune to 146.000 MHz, and select high power output. Key the transmitter and adjust VR1002 on the Mother Unit for 5 W on the meter. Select each of the low power settings, key the Tx, and confirm the following wattmeter readings:

#### RF Output Levels

LOW 1	0.2 - 0.4 W
LOW 2	1.4 - 2.0 W
LOW 3	2.5 - 3.5 W
HIGH	4.5 - 5.5 W

- Now, tune to the high and low band-edges, and confirm 4.5 - 5.5 W high power output, and between 0.1 - 0.5 W in the **LOW 1** setting.

## Receiver

Set up the test equipment as shown below for receiver alignment.

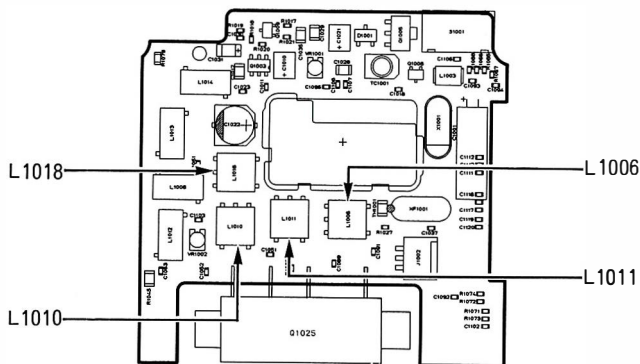

**Mother Unit RX Alignment Points**

### Interstage Transformers

- Connect the RF SG to the antenna jack, and connect the 8-Ω dummy load and SINAD meter to the **EAR** jack. Tune the transceiver and RF signal generator to 146.000MHz and inject a signal modulated with  $\pm 3.5$ kHz deviation of a 1-kHz tone.
- Adjust L1006, L1010, L1011 and L1018 in order on the Mother Unit for maximum indication on the SINAD meter. Confirm at least -9dB for 12dB SINAD at high & low band-edges and at 146.000 MHz.

### Internal System Alignment Routine

The remainder of the FT-11R alignment is accomplished by recalling a special routine programmed in the transceiver CPU. This alignment routine simplifies many previously complex discrete component settings and adjustments with digitally-controlled settings via front panel buttons and LCD indications.

Transceiver adjustments using this routine include:

- S-Meter S-1 Adjustment
- S-Meter Full-Scale Adjustment
- Squelch Low-Threshold Preset
- Squelch Tight-Threshold Preset

To call the routine program, set the transceiver to 146.000 MHz, then turn the transceiver off. Next press and hold the  $\text{VOL}_{\text{SQL}}$ ,  $\text{SQL}_{\text{VOL}}$  and  $\text{CALL}$  button together while powering the radio again.

The alignment routine is now active, and the display will now appear as below, indicating the 1st adjustment setting (S-Meter Full-Scale Adjust).

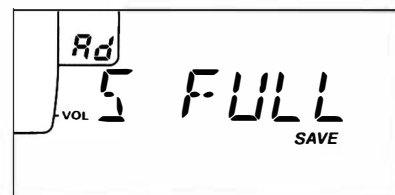

**S-Meter Full Scale Adjust**

In the alignment routine, each adjustment is selected in sequence by pressing the  $\text{MHz}^{\Delta}$  button. Repeatedly pressing  $\text{MHz}^{\Delta}$  will step through the four setting adjustments listed above. In the memory box "Rd" will appear, indicating the current selection can be adjusted. At this point, alignment is performed by pressing and holding the  $\text{EM}^{\text{D}}$  key for 1/2 second ("Rd" must appear *blinking* in memory box), then injecting a signal of a required frequency and level as described.

Pressing  $\text{SKIP}^{\text{MR}^*}$  after a level setting or adjustment has been made writes the entry into memory. To exit the alignment sub-routine and return the display indications to normal, press the  $\text{CALL}$  key. After performing the system alignment in its entirety, individual settings can be returned to and adjusted should the need arise.

# Alignment

## S-Meter Full-Scale Adjust ("5 FULL")

If you haven't done so already, perform the power-on key combination as previously described, and remember to press and hold (M) key for 1/2 second ("Rd" appears blinking), at the beginning of each selection.

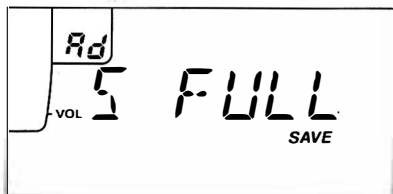

- Inject +20dB RF signal ( $\pm 3.5$ kHz deviation at 1-kHz) at the antenna input, press (MR)\* to save the setting ("Rd" stops blinking), then (MHz) to step to the next setting.

## Low-Scale S-1 Adjustment ("5 5 1")

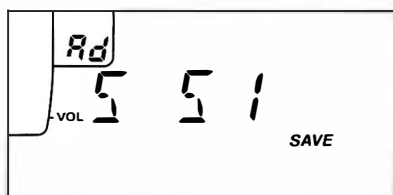

- Adjust the signal generator level -5dB, then press (MR)\* to (MHz).

## Squelch Preset Threshold ("50L TH")

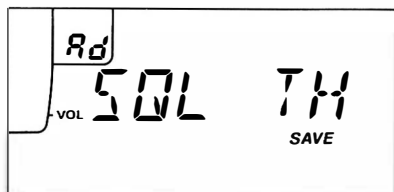

- Adjust the signal generator level for a -11dB signal, then press (MR)\* to (MHz).

## Squelch Preset Tight ("50L TI")

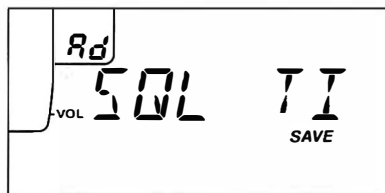

- Adjust the signal generator level for a -5dB signal, then press (MR)\* to (MHz).

This completes the internal alignment routine, to save all settings and exit, press (CALL), the frequency display will return to normal.

## CPU Reset

As a last resort, if you are unable to gain control of the transceiver, the FT-11R can be reset from the keypad to clear all settings, memories, channel step and repeater shifts to their factory defaults.

To do this, hold the (MR)\*, (VFO)# and (2) buttons depressed while turning on the transceiver

## *Receive Signal Path*

Incoming RF from the antenna jack is delivered to the Mother Unit and passes through a low-pass filter consisting of coils L1008, L1012, L1013 & L1014, capacitors C1070, C1071, C1072, C1073, C1074, & C1075 and antenna switching diodes D1007, & D1008 (PLS135) to the RF AMP. Signals within the frequency range of the transceiver then enter a varactor-tuned bandpass filter consisting of coils L1006, L1010, L1011, & L1018 capacitors C1047, C1063, C1064, & C1081 diodes D1006, D1011, & D1013, D1014 (all HVU202A) and RF amplification by Q1024 (2SC4537).

Buffered output from the VCO Unit is amplified by Q1007 (2SC4537) to provide a pure 1st local signal between 126.3 and 130.3 MHz for injection to the 1st mixer Q1021 (2SK882Y). The 17.7-MHz 1st mixer product then passes through monolithic crystal filter XF1001 (17M1B  $\pm$  7.5 kHz BW) to strip away all but the desired signal, which is then amplified by Q1015 (2SC4215).

The amplified 1st IF signal is applied to FM IF subsystem IC Q3001 (TK10930V) on the AF Unit, which contains the 2nd mixer, 2nd local oscillator, limiter amplifier, noise amplifier, S-meter amplifier. A 2nd local signal is generated from 17.245 MHz crystal X3001 to produce the 455 kHz 2nd IF when mixed with the 1st IF signal within Q3001. The 2nd IF then passes through ceramic filter CF3001 (CFWM455F), to strip away unwanted mixer products, and applied to the limiter amplifier in Q3001, which removes amplitude variations in the 455 kHz IF, before detection of the speech by ceramic discriminator CD3001 (CDBM455C7T).

Detected audio from Q3001 is then de-emphasized by the high-pass filter consisting of Q3008, & Q3009 (both 2SC4116) and level controlled by **VOL** IC Q3002 (M5222FP) before application to audio power amplifier Q3004 (TDA7233D), for up to 2 watts for the

optional headphone jack or 8-ohm loudspeaker.

## *Squelch Control*

The squelch circuitry consists of a noise amplifier, high-pass filter & squelch trigger within Q3001, noise detector D3001 (1SS302), squelch gate and level controller Q3002 (M5222FP), and control circuitry within Q2009 (HD4074629H).

When no carrier is received, noise at the output of the detector stage of Q3001 (pin 20) is detected by D3001 (1SS302) to provide a DC control voltage for squelch gate control. This voltage is delivered to NOISE pin 2 of Q2009 on the CNTL Unit. With no carrier present, pin 18 of Q2009 is high which signals the microprocessor to activate squelch gate Q3017 (DTC144EU), pulling the audio line to ground by Q3002 (M5222FP), thus silencing the receiver while no signal is being received.

## *Transmit Signal Path*

Speech input from the microphone is delivered to the AF Unit Unit for pre-emphasis by C3046, R3046, before amplification by Q3003-3, -2 (NJM3403AM). To prevent over-deviation, the audio is processed by IDC (instantaneous deviation control) Q3003-1 (NJM3403AM) and mute SW Q1008 (DTC124EU) before delivery to the modulator on the VCO Unit. If an external microphone is used; **PTT** switching is controlled by Q2002 (DTA144EE), which signals the microprocessor when the impedance at the microphone jack drops.

If a tone Burst or DTMF is enabled for transmission, the tone is generated by microprocessor Q2009 and mixed with transmitter audio at the Q3003-2.

The modulated audio is delivered to varactor diodes D6003 & D6004 (both HVU306A), frequency modulating the PLL carrier up to  $\pm$  5 kHz from the unmodulated carrier at the transmitting frequency. The modulated signal

## Circuit Description

---

from transmitter VCO Q6002 (2SC4226) is buffered by Q6003 (2SC4226) and delivered to the Main Unit for amplification by Q1007 (2SC4537). The low-level transmit signal is then applied to the PA Unit, where it is finally amplified by PA module Q1025 (S-AU28) up to 5 watts output power. The transmit signal then passes through antenna switch D1007 (RLS135) and is low-pass filtered to suppress away harmonic spurious radiation before delivery to the antenna.

### *Automatic Transmit Power Control*

RF power output from the final amplifier is sampled by C1067 and C1068 is rectified by D1012 (1SS321). The resulting DC is delivered via Power Adjustment potentiometer VR1002 to high/low power controller Q1017 (UMS1), which selects high or low power levels, controlled by the output microprocessor via Q2009. The output of Q1017 is inverted by Q1016 (2SC4617) and passed by Q1012 (2SA1586Y) back to the input of final amplifier ORed with the receive 5-V bus and applied to Q1020 to disable the transmitter as described above under the APC description.

### *Spurious Suppression*

Generation of spurious products by the transmitter is minimized by the fundamental carrier frequency being equal to the final transmitting frequency, modulated directly in the transmit VCO. Additional harmonic suppression is provided by a low-pass filter consisting of L1012, L1013, L1014 and C1070, C1071, C1072, C1073, C1074, and C1075, resulting in more than 60 dB of harmonic suppression (for transmitting frequencies in the amateur band) prior to delivery to the antenna.

### *PLL Frequency Synthesizer*

PLL circuitry on the Main Unit consists of PLL subsystem IC Q1001 (FQ7925), which contains a reference oscillator/divider, serial-to-parallel data latch, programmable divider

and a phase comparator. Stability is maintained by a regulated 3-V supply via Q1003 (TK11230M) to Q1001 and temperature compensating capacitors associated with the 12.8 MHz frequency reference crystal X1001.

Receiver VCO Q6001 (2SC4226) on the VCO Unit oscillates between 126.3 MHz and 130.3 MHz according to the programmed receiving frequency. The VCO output is buffered by Q6003 (2SC4226) on the VCO Unit, and then returned to the Mother Unit where a sample of the output is buffered by Q1004 (2SC4215) for application to the prescalar/swallow counter section of Q1001. There the VCO signal is divided by 64 or 65, according to a control signal from the data latch section of Q1001, before being applied to the programmable divider section in the PLL chip.

The data latch section of Q1001 also receives serial dividing data from microprocessor Q2009 on the Control Unit, which causes the pre-divided VCO signal to be further divided by 25,260 (20,208) to 26,060 (20,848) in the programmable divider section, depending upon the desired receive frequency, so as to produce a 5 kHz or 6.25 kHz derivative of the current VCO frequency. Meanwhile, the reference divider section in Q1001 divides the 12.8 MHz crystal reference by 2560 (or 2048) to produce the 5 kHz (or 6.25 kHz) loop reference (respectively).

The 5 kHz (or 6.25 kHz) signal from the programmable divider (derived from the VCO) and that derived from the crystal are applied to the phase detector section in Q1001, which produces a dual 3-V pulsed output with pulse duration depending on the phase difference between the input signals. This pulse train is converted to DC by charge pump section of Q1001, and is then fed through the low-pass filter to varactors D6001 & D6002 (both HVU306A) on the VCO Unit.

Changes in the level of the DC voltage applied to D6001 & D6002 affect the reactance



in the tank circuit of Receiver VCO Q6001, changing the oscillating frequency according to the phase difference between the signals derived from the VCO and the crystal reference oscillator. The VCO is thus phase-locked to the crystal reference oscillator.

The output of receiver VCO Q6001, after buffering by Q6003, is delivered to the Mother Unit for amplification by Q1007 (2SC4537) before application to the 1st mixer, as described previously.

Transmitter VCO Q6002 (2SC4226) oscillates between 144 MHz and 148 MHz according to the programmed transmit frequency. The remainder of the PLL circuitry is shared with the receiver. However, the dividing data from the microprocessor is such that the VCO frequency is at the actual transmit frequency (rather than offset for IFs, as in the receiving case). Also, the transmitter VCO is modulated by de-emphasized audio applied to D6003 & D6004, as described previously.

### *Transmit Inhibit*

When the transmit PLL is unlocked pin 18 of PLL chip Q1001 goes to a logic low, turning on both Q1002 and Q1020 (DTA124EE, DTC124EU), which then turns off Automatic Power Controller Q1018 and Q1019 (UMW1, 2SB1132Q) to disable the supply voltage to transmitter RF amplifiers Q1025, disabling the transmitter

### *Miscellaneous Circuits*

#### *Push-To-Talk Transmit Activation*

The **PTT** switch on the microphone is connected to pin 26 of microprocessor Q2009, so that when the **PTT** switch is closed, pin 15 of Q2009 goes low. This signals microprocessor to activate TX/RX controller Q1011 (UMH10), which then disables the receiver by disabling the 3-V supply bus at Q1006 (UMB10) to the front-end, IF, discriminator and receiver VCO circuitry. At the same time, Q1010 (UMB10) activates the transmit 3-V supply line to enable the transmitter.



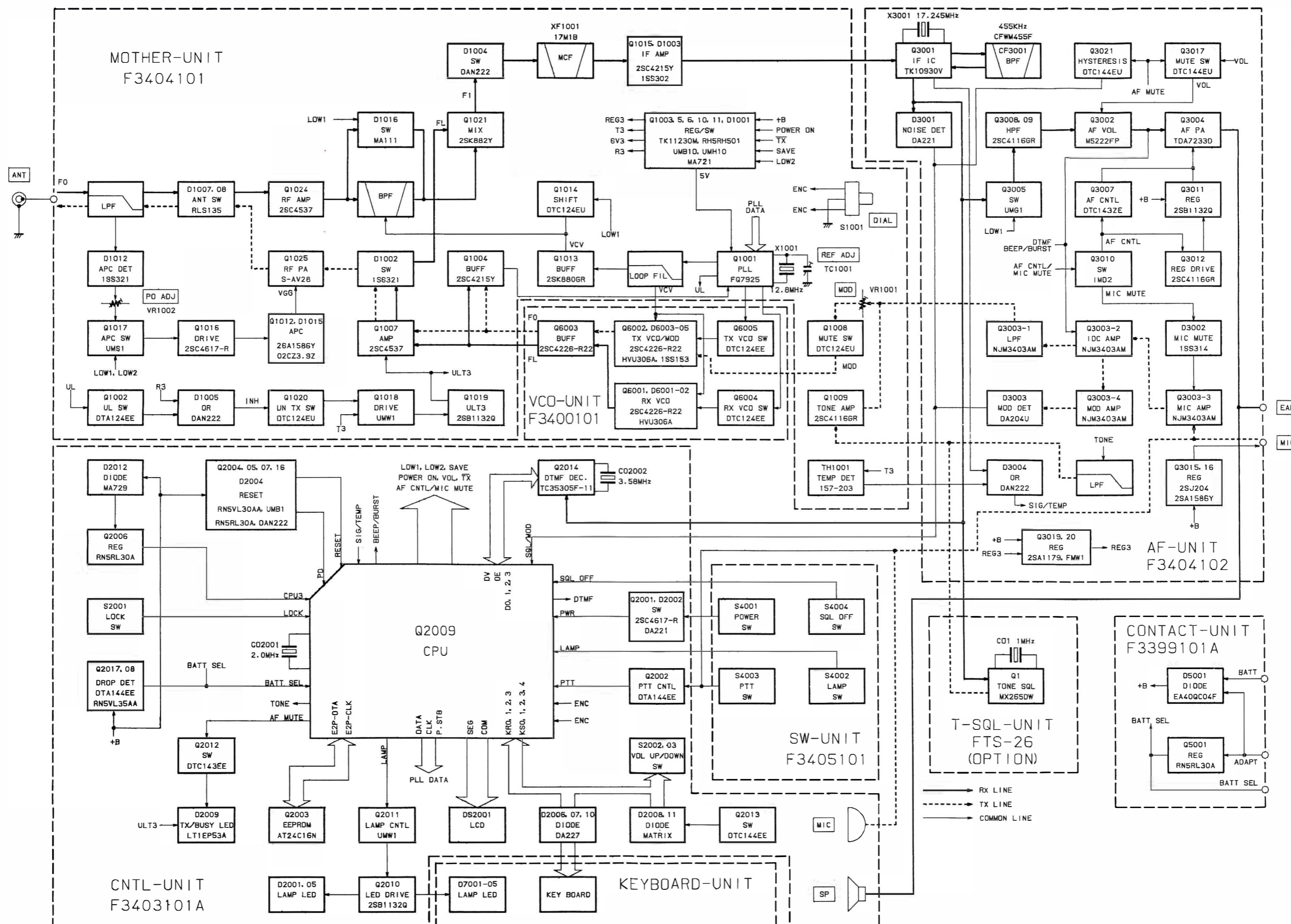

# Interconnection Diagram

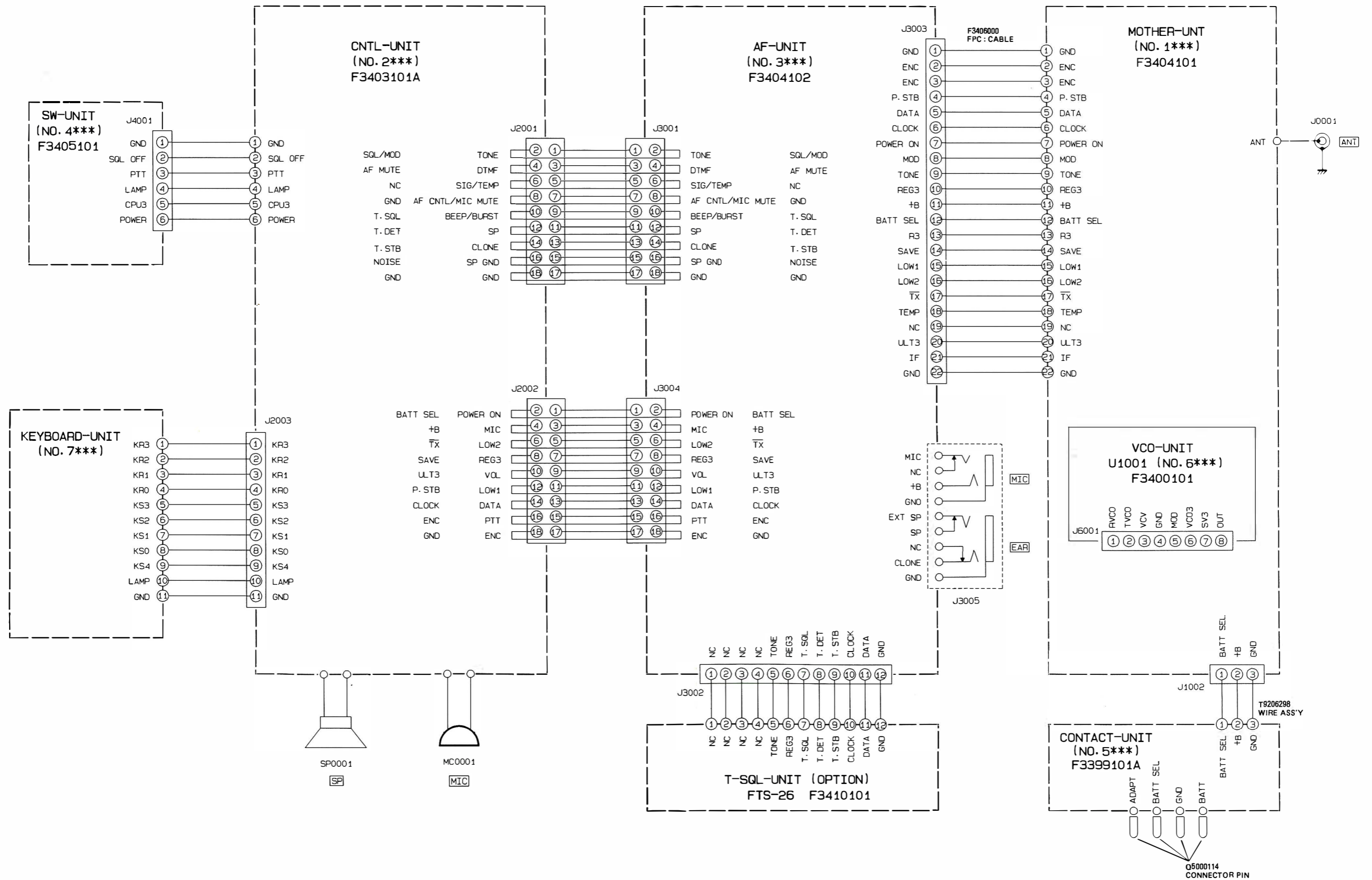

Circuit Diagram

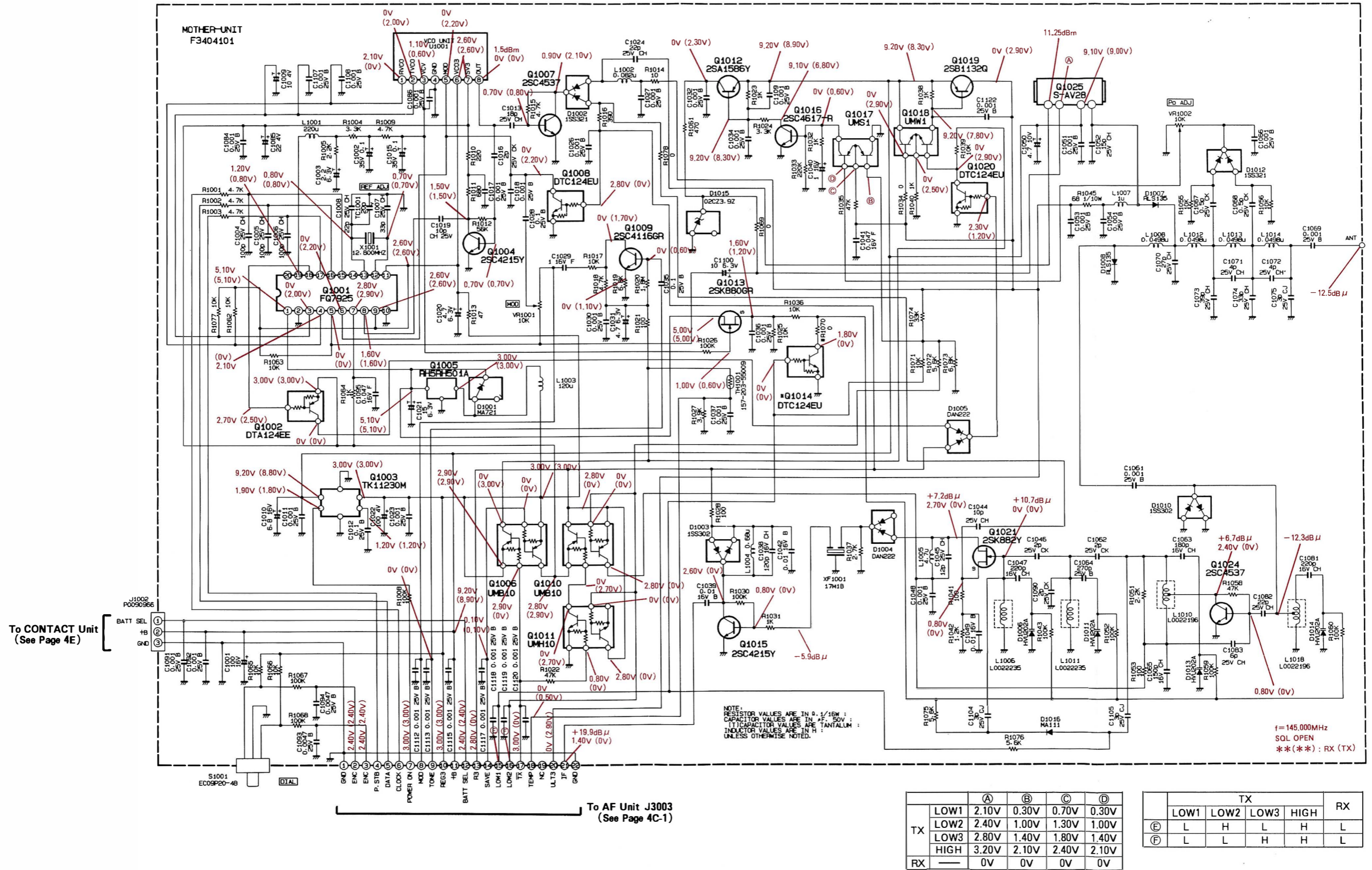



Parts Layout

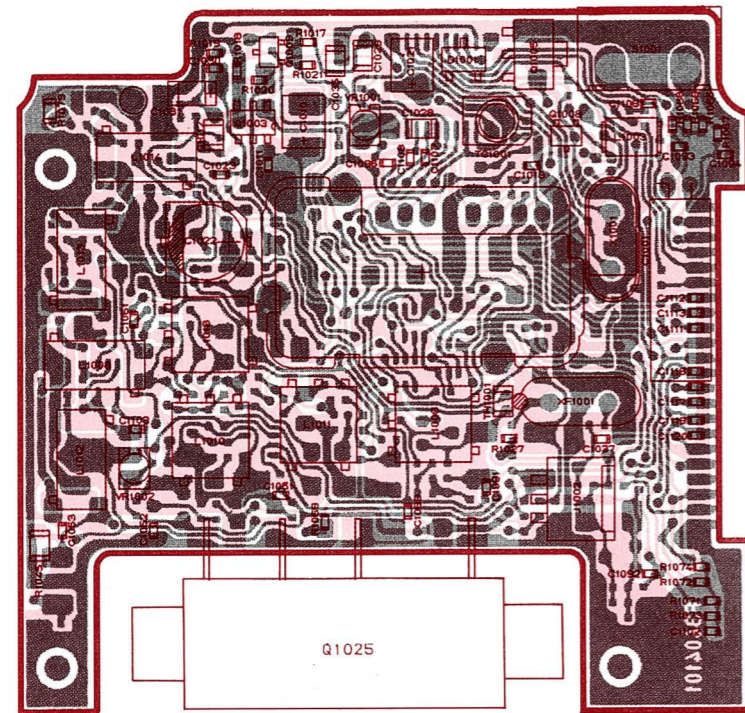

obverse view of component side

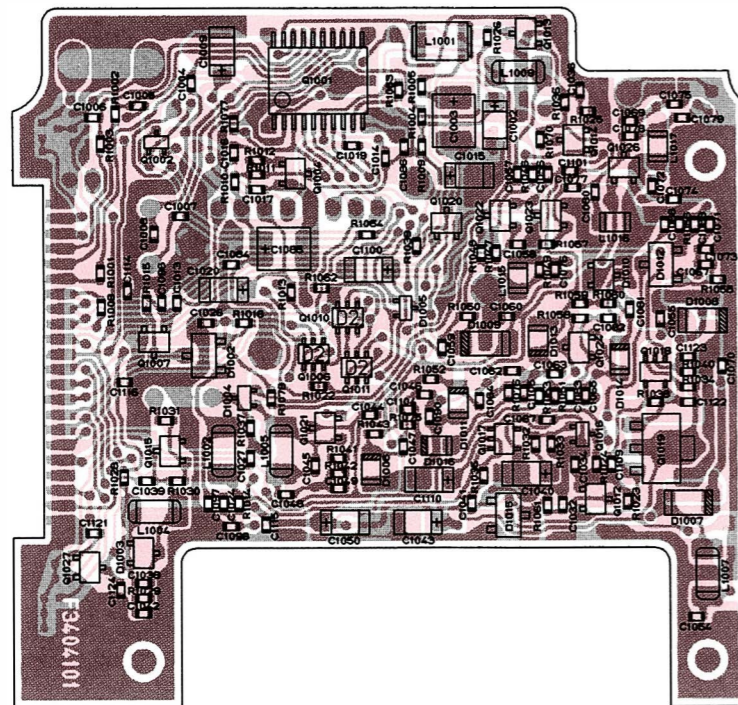

obverse view of chip side

J1002  
To CONTACT Unit  
(See Page 4E)  
1. BATT SEL  
2. + B  
3. GND

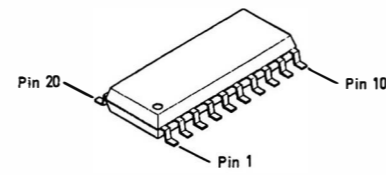

FQ7925 (Q1001)

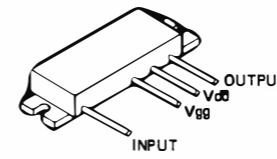

S-AV28 (Q1025)

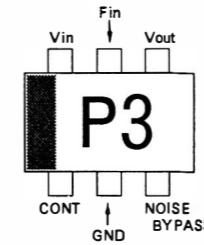

TK11230M (Q1003)

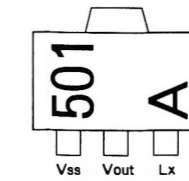

RH5RH501A (501A) (Q1005)

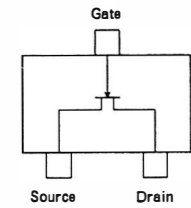

2SK880GR (XG) (Q1013)

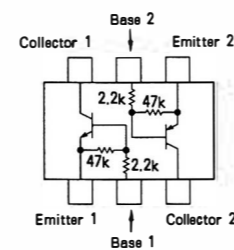

UMB10 (B10) (Q1006, 1010)

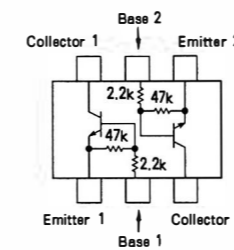

UMH10 (H10) (Q1011)

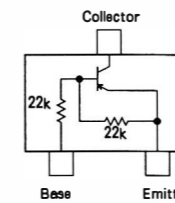

DTA124EE (15) (Q1002)

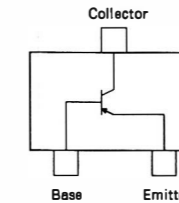

2SA1586Y (SY) (Q1012)

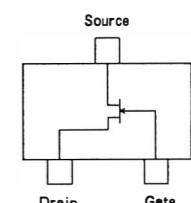

2SK882Y (TY) (Q1021)

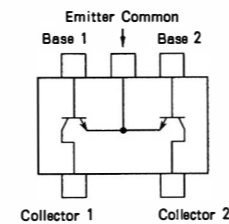

UMW1 (W1) (Q1018)

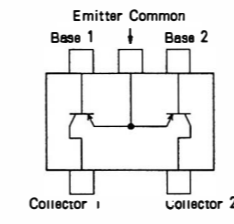

UMS1 (S1) (Q1017)

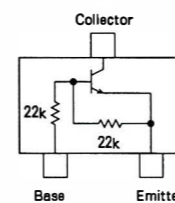

DTC124EU (25) (Q1008, 1014, 1020, 1026)

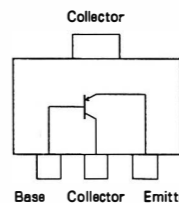

2SB1132 (BAQ) (Q1019)

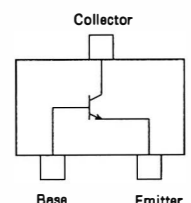

2SC4116GR (LG) (Q1009)

2SC4537 (IS-) (Q1007, 1023, 1024)

2SC4215Y (QY) (Q1004, 1015)

2SC4617 (BR) (Q1016)

2SC4245 (HB) (Q1002)

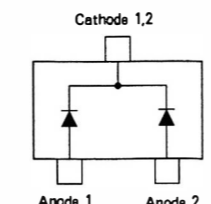

DAN222 (N) (D1004, 1005)

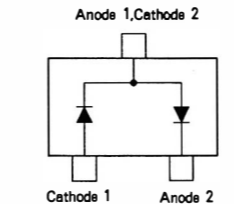

1SS321 (F9) (D1002, 1012)

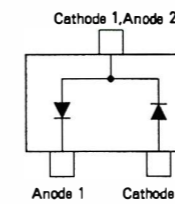

1SS302 (C3) (D1003, 1010)

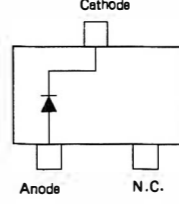

MA721 (M1M) (D1001)

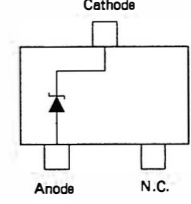

02CZ3.9Z (3.9) (D1015)





## Parts List

REF.	MFGR'S DESIG	VALUE	WV	TOL.	DESCRIPTION	YAESU P/N	VERS.
*** MOTHER UNIT***							
	PCB With VCO UNIT					CP4505003	TYP A2
	PCB With VCO UNIT					CP4505004	TYP A3
	PCB With VCO UNIT					CP4505005	TYP B1
	PCB With VCO UNIT					CP4505006	TYP B3
	PCB With VCO UNIT					CP4505007	TYP H4
	Printed Circuit Board					F3404101	
C 1001	AL. ELECTRO. CAP.	100uF	16V		CEDSM1C101M	K40129060	
C 1002	TANTALUM CHIP CAP.	0.1uF	35V		TESVA1V104M1-8R	K78160025	
C 1003	TANTALUM CHIP CAP.	10uF	6.3V		TEMSVA0J106M-8R	K78080027	
C 1004	CHIP CAP.	100pF	25V	CH	TMK105CH101J-F	K22148238	
C 1005	CHIP CAP.	100pF	25V	CH	TMK105CH101J-F	K22148238	
C 1006	CHIP CAP.	100pF	25V	CH	TMK105CH101J-F	K22148238	
C 1007	CHIP CAP.	33pF	25V	CH	TMK105CH330J-F	K22148226	
C 1008	CHIP CAP.	22pF	25V	CH	TMK105CH220J-F	K22148222	
C 1009	TANTALUM CHIP CAP.	1uF	16V		TESVA1C105M1-8R	K78120009	
C 1010	TANTALUM CHIP CAP.	6.8uF	16V		TEMSVB21C685M-8R	K78120017	
C 1011	CHIP CAP.	0.001uF	25V	B	TMK105B102K-F	K22148820	
C 1012	CHIP CAP.	0.1uF	25V	B	GRM40B104M25PT	K22140811	
C 1013	CHIP CAP.	27pF	25V	CH	TMK105CH270J-F	K22148224	
C 1015	TANTALUM CHIP CAP.	0.1uF	35V		TESVA1V104M1-8R	K78160025	
C 1016	CHIP CAP.	2pF	25V	CK	TMK105CK020C-F	K22148206	
C 1017	CHIP CAP.	0.001uF	25V	B	TMK105B102K-F	K22148820	
C 1018	CHIP CAP.	0.001uF	25V	B	TMK105B102K-F	K22148820	
C 1019	CHIP CAP.	10pF	25V	CH	TMK105CH100D-F	K22148214	
C 1020	TANTALUM CHIP CAP.	4.7uF	6.3V		TEMSVA0J475M-8R	K78080017	
C 1021	TANTALUM CHIP CAP.	15uF	6.3V		TEMSVB20J156M-8R	K78080023	
C 1022	AL. ELECTRO. CAP.	100uF	4V		ECEVOGA101SR	K48060001	
C 1023	CHIP CAP.	0.001uF	25V	B	TMK105B102K-F	K22148820	
C 1024	CHIP CAP.	22pF	25V	CH	TMK105CH220J-F	K22148222	
C 1026	CHIP CAP.	0.001uF	25V	B	TMK105B102K-F	K22148820	
C 1027	CHIP CAP.	0.001uF	25V	B	TMK105B102K-F	K22148820	
C 1028	TANTALUM CHIP CAP.	4.7uF	6.3V		TEMSVA0J475M-8R	K78080017	
C 1029	CHIP CAP.	1uF	16V	F	EMK212F105Z00T	K22121001	
C 1030	CHIP CAP.	0.001uF	25V	B	TMK105B102K-F	K22148820	
C 1031	TANTALUM CHIP CAP.	4.7uF	6.3V		TEMSVA0J475M-8R	K78080017	
C 1032	CHIP CAP.	0.001uF	25V	B	TMK105B102K-F	K22148820	
C 1034	CHIP CAP.	0.001uF	25V	B	TMK105B102K-F	K22148820	
C 1035	CHIP CAP.	0.1uF	25V	B	GRM40B104M25PT	K22140811	
C 1036	CHIP CAP.	0.001uF	25V	B	TMK105B102K-F	K22148820	
C 1037	CHIP CAP.	0.001uF	25V	B	TMK105B102K-F	K22148820	
C 1038	CHIP CAP.	120pF	16V	CH	EMK105CH121J-F	K22128202	
C 1039	CHIP CAP.	0.01uF	16V	B	EMK105B103K-F	K22128802	
C 1040	TANTALUM CHIP CAP.	1uF	16V		TESVA1C105M1-8R	K78120009	
C 1041	CHIP CAP.	0.047uF	16V	F	EMK105F473Z-F	K22129002	
C 1042	CHIP CAP.	0.01uF	16V	B	EMK105B103K-F	K22128802	
C 1043	TANTALUM CHIP CAP.	10uF	6.3V		TEMSVA0J106M-8R	K78080027	
C 1044	CHIP CAP.	10pF	25V	CH	TMK105CH100D-F	K22148214	
C 1045	CHIP CAP.	12pF	25V	CH	TMK105CH120J-F	K22148216	
C 1046	CHIP CAP.	1pF	25V	CK	TMK105CK010C-F	K22148205	
C 1047	CHIP CAP.	120pF	16V	CH	EMK105CH121J-F	K22128202	
C 1048	CHIP CAP.	0.001uF	25V	B	TMK105B102K-F	K22148820	

# MOTHER Unit

REF.	MFGR'S DESIG	VALUE	WV	TOL.	DESCRIPTION	YAESU P/N	VERS.
C 1049	CHIP CAP.	0.01uF	16V	B	EMK105B103K-F	K22128802	
C 1050	TANTALUM CHIP CAP.	3.3uF	16V		TEMSVA1C335M-8R	K78120021	
C 1051	CHIP CAP.	0.001uF	25V	B	TMK105B102K-F	K22148820	
C 1052	CHIP CAP.	15pF	25V	CH	TMK105CH150J-F	K22148218	
C 1053	CHIP CAP.	0.001uF	25V	B	TMK105B102K-F	K22148820	
C 1054	CHIP CAP.	0.001uF	25V	B	TMK105B102K-F	K22148820	
C 1056	CHIP CAP.	0.001uF	25V	B	TMK105B102K-F	K22148820	
C 1057	CHIP CAP.	15pF	25V	CH	TMK105CH150J-F	K22148218	
C 1058	CHIP CAP.	56pF	25V	CH	TMK105CH560J-F	K22148232	
C 1059	CHIP CAP.	1pF	25V	CK	TMK105CK010C-F	K22148205	
C 1061	CHIP CAP.	12pF	25V	CH	TMK105CH120J-F	K22148216	
C 1062	CHIP CAP.	1pF	25V	CK	TMK105CK010C-F	K22148205	
C 1063	CHIP CAP.	180pF	16V	CH	EMK105CH181J-F	K22128206	
C 1064	CHIP CAP.	180pF	16V	CH	EMK105CH181J-F	K22128206	
C 1065	CHIP CAP.	150pF	16V	CH	EMK105CH151J-F	K22128204	
C 1066	CHIP CAP.	0.001uF	25V	B	TMK105B102K-F	K22148820	
C 1067	CHIP CAP.	0.5pF	25V	CK	TMK105CK0R5C-F	K22148204	
C 1068	CHIP CAP.	0.5pF	25V	CK	TMK105CK0R5C-F	K22148204	
C 1069	CHIP CAP.	0.001uF	25V	B	TMK105B102K-F	K22148820	
C 1070	CHIP CAP.	27pF	25V	CH	TMK105CH270J-F	K22148224	
C 1071	CHIP CAP.	4pF	25V	CH	TMK105CH040C-F	K22148208	
C 1072	CHIP CAP.	4pF	25V	CH	TMK105CH040C-F	K22148208	
C 1073	CHIP CAP.	39pF	25V	CH	TMK105CH390J-F	K22148228	
C 1074	CHIP CAP.	33pF	25V	CH	TMK105CH330J-F	K22148226	
C 1075	CHIP CAP.	3pF	25V	CJ	TMK105CJ030C-F	K22148207	
C 1076	CHIP CAP.	0.001uF	25V	B	TMK105B102K-F	K22148820	
C 1077	CHIP CAP.	15pF	25V	CH	TMK105CH150J-F	K22148218	
C 1078	CHIP CAP.	5pF	25V	CH	TMK105CH050C-F	K22148209	
C 1079	CHIP CAP.	10pF	25V	CH	TMK105CH100D-F	K22148214	
C 1080	CHIP CAP.	22pF	25V	CH	TMK105CH220J-F	K22148222	
C 1081	CHIP CAP.	8pF	25V	CH	TMK105CH080D-F	K22148212	
C 1082	CHIP CAP.	33pF	25V	CH	TMK105CH330J-F	K22148226	
C 1083	CHIP CAP.	6pF	25V	CH	TMK105CH060D-F	K22148210	
C 1084	CHIP CAP.	0.001uF	25V	B	TMK105B102K-F	K22148820	
C 1085	TANTALUM CHIP CAP.	22uF	4V		TEMSVB20G226M-8R	K78060011	
C 1086	CHIP CAP.	0.001uF	25V	B	TMK105B102K-F	K22148820	
C 1090	CHIP CAP.	2pF	25V	CK	TMK105CK020C-F	K22148206	
C 1091	CHIP CAP.	0.001uF	25V	B	TMK105B102K-F	K22148820	
C 1092	CHIP CAP.	0.001uF	25V	B	TMK105B102K-F	K22148820	
C 1093	CHIP CAP.	0.0047uF	25V	B	TMK105B472K-F	K22148801	
C 1094	CHIP CAP.	0.0047uF	25V	B	TMK105B472K-F	K22148801	
C 1095	CHIP CAP.	0.047uF	16V	F	EMK105F473Z-F	K22129002	
C 1104	CHIP CAP.	3pF	25V	CJ	TMK105CJ030C-F	K22148207	
C 1105	CHIP CAP.	3pF	25V	CJ	TMK105CJ030C-F	K22148207	
C 1107	CHIP CAP.	0.001uF	25V	B	TMK105B102K-F	K22148820	
C 1108	CHIP CAP.	0.001uF	25V	B	TMK105B102K-F	K22148820	
C 1109	CHIP CAP.	0.001uF	25V	B	TMK105B102K-F	K22148820	
C 1112	CHIP CAP.	0.001uF	25V	B	TMK105B102K-F	K22148820	
C 1113	CHIP CAP.	0.001uF	25V	B	TMK105B102K-F	K22148820	
C 1115	CHIP CAP.	0.001uF	25V	B	TMK105B102K-F	K22148820	
C 1117	CHIP CAP.	0.001uF	25V	B	TMK105B102K-F	K22148820	

# MOTHER Unit

REF.	MFGR'S DESIG	VALUE	WV	TOL.	DESCRIPTION	YAESU P/N	VERS.
C 1118	CHIP CAP.	0.001uF	25V	B	TMK105B102K-F	K22148820	
C 1119	CHIP CAP.	0.001uF	25V	B	TMK105B102K-F	K22148820	
C 1120	CHIP CAP.	0.001uF	25V	B	TMK105B102K-F	K22148820	
C 1122	CHIP CAP.	0.001uF	25V	B	TMK105B102K-F	K22148820	
C 1125	CHIP CAP.	0.001uF	50V	B	GRM39B102M50PT	K22174809	
C 1126	CHIP CAP.	0.001uF	50V	B	GRM39B102M50PT	K22174809	
C 1127	CHIP CAP.	100pF	25V	CH	TMK105CH101J-F	K22148238	
D 1001	DIODE				MA721 (TX)	G2070298	
D 1002	DIODE				1SS321 TE85R	G2070076	
D 1003	DIODE				1SS302 TE85R	G2070088	
D 1004	DIODE				DAN222 TL	G2070174	
D 1005	DIODE				DAN222 TL	G2070174	
D 1006	DIODE				HVU202A-TR	G2070332	
D 1007	DIODE				RLS135 TE-11	G2070128	
D 1008	DIODE				RLS135 TE-11	G2070128	
D 1009	DIODE				RLS135 TE-11	G2070128	
D 1010	DIODE				1SS302 TE85R	G2070088	
D 1011	DIODE				HVU202A-TR	G2070332	
D 1012	DIODE				1SS321 TE85R	G2070076	
D 1013	DIODE				HVU202A-TR	G2070332	
D 1014	DIODE				HVU202A-TR	G2070332	
D 1015	DIODE				O2CZ3.9Z TE85R	G2070144	
D 1016	DIODE				MA111-(TX)	G2070338	
J 1002	CONNECTOR				CHP2703-0101	P0090966	
L 1001	M. RFC	220uH			FLC32T-221J	L1690231	
L 1002	M. RFC	0.082uH			LER015T082M	L1690197	
L 1003	M. RFC	120uH			FLC32T-121J	L1690228	
L 1004	M. RFC	0.68uH			LER015TR68M	L1690117	
L 1005	M. RFC	4.7uH			LER015T4R7K	L1690127	
L 1006	COIL				639BN-0057Z=P3	L0022235	
L 1007	M. RFC	1uH			LER015T1R0M	L1690119	
L 1008	M. RFC	0.0498uH			36CS 656LZ-09K=P3	L1690248	
L 1009	M. RFC	4.7uH			LER015T4R7K	L1690127	
L 1010	COIL				639BN-0056BY=P3	L0022196	
L 1011	COIL				639BN-0057Z=P3	L0022235	
L 1012	M. RFC	0.0498uH			36CS 656LZ-09K=P3	L1690248	
L 1013	M. RFC	0.0498uH			36CS 656LZ-09K=P3	L1690248	
L 1014	M. RFC	0.0498uH			36CS 656LZ-09K=P3	L1690248	
L 1015	M. RFC	0.015uH			LL2012-F15N	L1690168	
L 1016	M. RFC	0.022uH			LL2012-F22N	L1690170	
L 1017	M. RFC	0.022uH			LL2012-F22N	L1690170	
L 1018	COIL				639BN-0056BY=P3	L0022196	
Q 1001	IC				FQ7925	G1091710	
Q 1002	TRANSISTOR				DTA124EE TL	G3070116	
Q 1003	IC				TK11230M	G1091656	
Q 1004	TRANSISTOR				2SC4215Y TE85R	G3342157Y	
Q 1005	IC				RH5RH501A-T1	G1091603	

# MOTHER Unit

REF.	MFGR'S DESIG	VALUE	WV	TOL.	DESCRIPTION	YAESU P/N	VERS.
Q 1006	TRANSISTOR				UMB10 TN	G3070108	
Q 1007	TRANSISTOR				2SC4537 TR	G3345377	
Q 1008	TRANSISTOR				DTC124EU T107	G3070045	
Q 1009	TRANSISTOR				2SC4116GR TE85R	G3341167G	
Q 1010	TRANSISTOR				UMB10 TN	G3070108	
Q 1011	TRANSISTOR				UMH10 TN	G3070096	
Q 1012	TRANSISTOR				2SA1586Y TE85R	G3115867Y	
Q 1013	FET				2SK880GR TE85R	G3808807G	
Q 1014	TRANSISTOR				DTC124EU T107	G3070045	
Q 1015	TRANSISTOR				2SC4215Y TE85R	G3342157Y	
Q 1016	TRANSISTOR				2SC4617 TL R	G3346178R	
Q 1017	TRANSISTOR				UMS1 TR	G3070077	
Q 1018	TRANSISTOR				UMW1 TR	G3070078	
Q 1019	TRANSISTOR				2SB1132 T100 Q	G3211327Q	
Q 1020	TRANSISTOR				DTC124EU T107	G3070045	
Q 1021	FET				2SK882Y TE85R	G3808827Y	
Q 1022	TRANSISTOR				2SC4245 TE85R	G3342457	
Q 1023	TRANSISTOR				2SC4537 TR	G3345377	
Q 1024	TRANSISTOR				2SC4537 TR	G3345377	
Q 1025	IC				S-AV28	G1091662	
Q 1026	TRANSISTOR				DTC124EU T107	G3070045	
R 1001	CHIP RES.	4.7K	1/16W	5%	RMC1/16S 472JTH	J24189033	
R 1002	CHIP RES.	4.7K	1/16W	5%	RMC1/16S 472JTH	J24189033	
R 1003	CHIP RES.	4.7K	1/16W	5%	RMC1/16S 472JTH	J24189033	
R 1004	CHIP RES.	2.2K	1/16W	5%	RMC1/16S 222JTH	J24189029	
R 1005	CHIP RES.	560	1/16W	5%	RMC1/16S 561JTH	J24189022	
R 1008	CHIP RES.	100K	1/16W	5%	RMC1/16S 104JTH	J24189049	
R 1009	CHIP RES.	4.7K	1/16W	5%	RMC1/16S 472JTH	J24189033	
R 1010	CHIP RES.	220	1/16W	5%	RMC1/16S 221JTH	J24189017	
R 1011	CHIP RES.	560	1/16W	5%	RMC1/16S 561JTH	J24189022	
R 1012	CHIP RES.	56K	1/16W	5%	RMC1/16S 563JTH	J24189046	
R 1013	CHIP RES.	47	1/16W	5%	RMC1/16S 470JTH	J24189009	
R 1014	CHIP RES.	10	1/16W	5%	RMC1/16S 100JTH	J24189001	
R 1015	CHIP RES.	4.7K	1/16W	5%	RMC1/16S 472JTH	J24189033	
R 1016	CHIP RES.	390	1/16W	5%	RMC1/16S 391JTH	J24189020	
R 1017	CHIP RES.	10K	1/16W	5%	RMC1/16S 103JTH	J24189037	
R 1018	CHIP RES.	4.7K	1/16W	5%	RMC1/16S 472JTH	J24189033	
R 1019	CHIP RES.	10K	1/16W	5%	RMC1/16S 103JTH	J24189037	
R 1020	CHIP RES.	1.8M	1/16W		RMC1/16S 185JTH	J24189064	
R 1021	CHIP RES.	100	1/16W	5%	RMC1/16S 101JTH	J24189013	
R 1022	CHIP RES.	47K	1/16W	5%	RMC1/16S 473JTH	J24189045	
R 1023	CHIP RES.	1K	1/16W	5%	RMC1/16S 102JTH	J24189025	
R 1024	CHIP RES.	3.3K	1/16W	5%	RMC1/16S 332JTH	J24189031	
R 1025	CHIP RES.	10K	1/16W	5%	RMC1/16S 103JTH	J24189037	
R 1026	CHIP RES.	100K	1/16W	5%	RMC1/16S 104JTH	J24189049	
R 1027	CHIP RES.	3.3K	1/16W	5%	RMC1/16S 332JTH	J24189031	
R 1028	CHIP RES.	100	1/16W	5%	RMC1/16S 101JTH	J24189013	
R 1030	CHIP RES.	100K	1/16W	5%	RMC1/16S 104JTH	J24189049	
R 1032	CHIP RES.	1K	1/16W	5%	RMC1/16S 102JTH	J24189025	
R 1033	CHIP RES.	220K	1/16W	5%	RMC1/16S 224JTH	J24189053	

# MOTHER Unit

REF.	MFGR'S DESIG	VALUE	WV	TOL.	DESCRIPTION	YAESU P/N	VERS.
R 1034	CHIP RES.	0	1/16W		RMC1/16S JPTH	J24189070	
R 1035	CHIP RES.	47K	1/16W	5%	RMC1/16S 473JTH	J24189045	
R 1036	CHIP RES.	10K	1/16W	5%	RMC1/16S 103JTH	J24189037	
R 1037	CHIP RES.	2.7K	1/16W	5%	RMC1/16S 272JTH	J24189030	
R 1038	CHIP RES.	1K	1/16W	5%	RMC1/16S 102JTH	J24189025	
R 1039	CHIP RES.	10K	1/16W	5%	RMC1/16S 103JTH	J24189037	
R 1040	CHIP RES.	1K	1/16W	5%	RMC1/16S 102JTH	J24189025	
R 1041	CHIP RES.	100	1/16W	5%	RMC1/16S 101JTH	J24189013	
R 1042	CHIP RES.	1K	1/16W	5%	RMC1/16S 102JTH	J24189025	
R 1043	CHIP RES.	100K	1/16W	5%	RMC1/16S 104JTH	J24189049	
R 1045	CHIP RES.	68	1/10W	5%	RMC1/10T 680J	J24205680	
R 1046	CHIP RES.	100	1/16W	5%	RMC1/16S 101JTH	J24189013	
R 1047	CHIP RES.	1.2M	1/16W		RMC1/16S 125JTH	J24189062	
R 1048	CHIP RES.	390	1/16W	5%	RMC1/16S 391JTH	J24189020	
R 1049	CHIP RES.	220	1/16W	5%	RMC1/16S 221JTH	J24189017	
R 1050	CHIP RES.	10K	1/16W	5%	RMC1/16S 103JTH	J24189037	
R 1051	CHIP RES.	2.2K	1/16W	5%	RMC1/16S 222JTH	J24189029	
R 1052	CHIP RES.	100K	1/16W	5%	RMC1/16S 104JTH	J24189049	
R 1053	CHIP RES.	100	1/16W	5%	RMC1/16S 101JTH	J24189013	
R 1055	CHIP RES.	10K	1/16W	5%	RMC1/16S 103JTH	J24189037	
R 1056	CHIP RES.	10K	1/16W	5%	RMC1/16S 103JTH	J24189037	
R 1057	CHIP RES.	27K	1/16W	5%	RMC1/16S 273JTH	J24189042	
R 1058	CHIP RES.	47K	1/16W	5%	RMC1/16S 473JTH	J24189045	
R 1059	CHIP RES.	100K	1/16W	5%	RMC1/16S 104JTH	J24189049	
R 1060	CHIP RES.	100K	1/16W	5%	RMC1/16S 104JTH	J24189049	
R 1061	CHIP RES.	470	1/16W	5%	RMC1/16S 471JTH	J24189021	
R 1062	CHIP RES.	10K	1/16W	5%	RMC1/16S 103JTH	J24189037	
R 1063	CHIP RES.	10K	1/16W	5%	RMC1/16S 103JTH	J24189037	
R 1064	CHIP RES.	1K	1/16W	5%	RMC1/16S 102JTH	J24189025	
R 1065	CHIP RES.	10K	1/16W	5%	RMC1/16S 103JTH	J24189037	
R 1066	CHIP RES.	10K	1/16W	5%	RMC1/16S 103JTH	J24189037	
R 1067	CHIP RES.	100K	1/16W	5%	RMC1/16S 104JTH	J24189049	
R 1068	CHIP RES.	100K	1/16W	5%	RMC1/16S 104JTH	J24189049	
R 1069	CHIP RES.	0	1/16W		RMC1/16S JPTH	J24189070	
R 1070	CHIP RES.	0	1/16W		RMC1/16S JPTH	J24189070	
R 1071	CHIP RES.	10K	1/16W	5%	RMC1/16S 103JTH	J24189037	
R 1072	CHIP RES.	5.6K	1/16W	5%	RMC1/16S 562JTH	J24189034	
R 1073	CHIP RES.	6.8K	1/16W	5%	RMC1/16S 682JTH	J24189035	
R 1074	CHIP RES.	33K	1/16W	5%	RMC1/16S 333JTH	J24189043	
R 1075	CHIP RES.	5.6K	1/16W	5%	RMC1/16S 562JTH	J24189034	
R 1076	CHIP RES.	5.6K	1/16W	5%	RMC1/16S 562JTH	J24189034	
R 1077	CHIP RES.	10K	1/16W	5%	RMC1/16S 103JTH	J24189037	
R 1078	CHIP RES.	0	1/16W		RMC1/16S JPTH	J24189070	
R 1080	CHIP RES.	47	1/16W	5%	RMC1/16 470JATP	J24185470	
R 1081	CHIP RES.	2.7K	1/16W	5%	RMC1/16 272JATP	J24185272	
R 1082	CHIP RES.	0	1/16W	5%	RMC1/16 000JATP	J24185000	
R 1083	CHIP RES.	2.7K	1/16W	5%	RMC1/16 272JATP	J24185272	
R 1084	CHIP RES.	22K	1/16W	5%	RMC1/16 223JATP	J24185223	
S 1001	ROTARY CODE S.W.				EC09P20-48	Q9000565	

# MOTHER Unit

---

REF.	MFGR'S DESIG	VALUE	WV	TOL.	DESCRIPTION	YAESU P/N	VERS.
TC1001	TRIMMER CAP.	20pF			ECR-KNO20E11X	K91000154	
TH1001	THERMISTOR				157-203-55009TP	G9090045	
VR1001	POT.	10K			MVR22HXBRN103	J51799103	
VR1002	POT.	10K			MVR22HXBRN103	J51799103	
X 1001	XTAL	12.800MHz				H0103067	
XF1001	XTAL				17M1B	H1102239	
	TERMINAL					R0143380	
	PLATE (PA)					R0147980	
	SHIELD CASE (PA)					R0147990	







Parts Layout

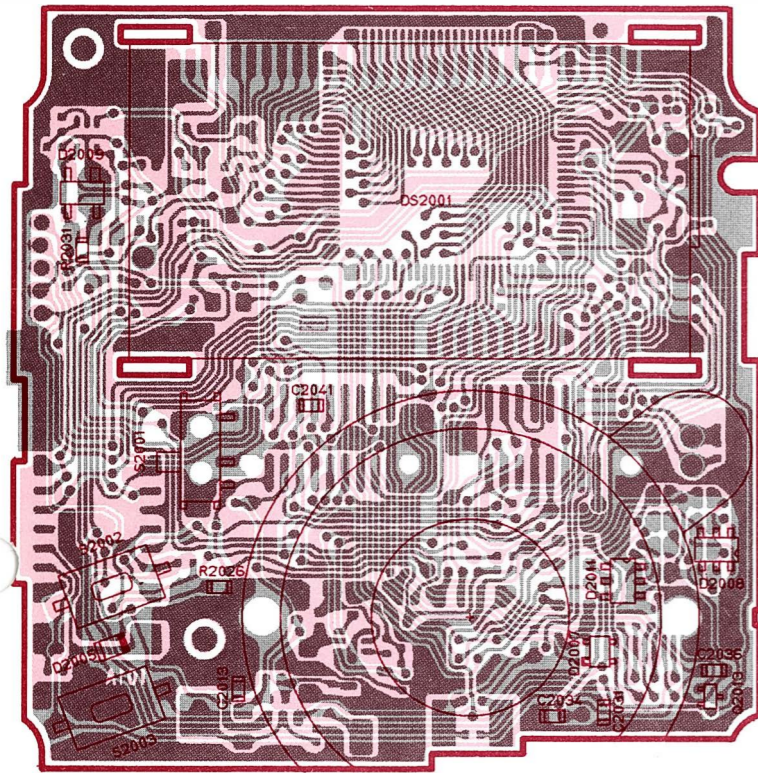

obverse view of display side

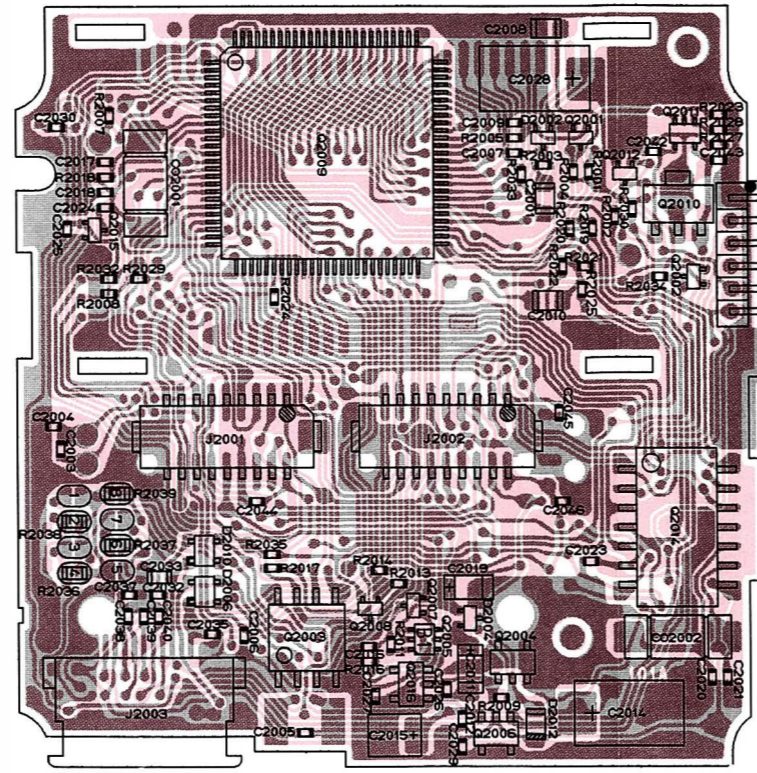

obverse view of component side

- 11. GND
  - 10. LAMP
  - 9. KS4
  - 8. KS0
  - 7. KS1
  - 6. KS2
  - 5. KS3
  - 4. KF0
  - 3. KF1
  - 2. KF2
  - 1. KF3
- To KEYBOARD Unit  
(See Page 4G)

To SW Unit J4001  
(See Page 4D)

- 1. GND
- 2. SQL OFF
- 3. PTT
- 4. LAMP
- 5. CPU3
- 6. POWER

J2001 To AF Unit J3001  
(See Page 4C-3)

- 17. GND
- 16. NOISE
- 14. T.STB
- 12. T.DET
- 10. T.SOL
- 8. GND
- 6. NC
- 4. AF MUTE
- 2. SOL/MOD
- 1. TONE
- 11. SP
- 9. BEEP/BURST
- 7. AF ONT/MIC MUTE
- 5. SIG/TEMP
- 3. DTMF
- 1. TONE

J2002 To AF Unit J3004  
(See Page 4C-3)

- 17. ENC
- 16. ENC
- 14. CLOCK
- 12. P.STB
- 10. ULT3
- 8. SAVE
- 6. TX
- 4. +B
- 2. BATT\_SEL
- 1. POWER ON
- 15. PTT
- 13. DATA
- 11. LOW1
- 9. VOL
- 7. REG3
- 5. LOW2
- 3. MIC

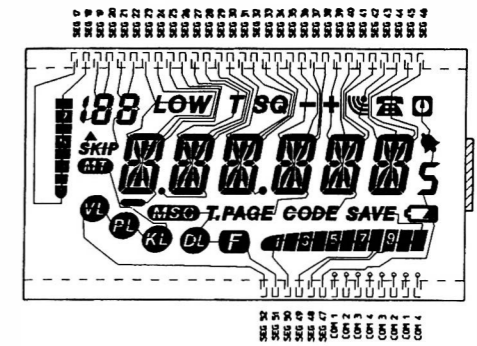

LCD LCM-218BS, Segmentation Circuit Diagram

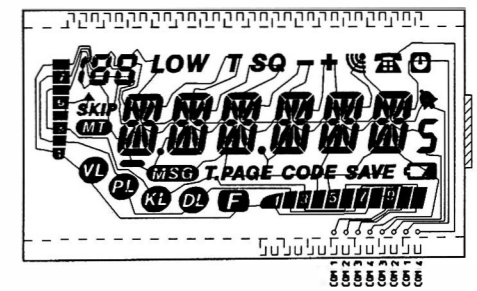

LCD LCM-218BS, Backplane Circuit Diagram

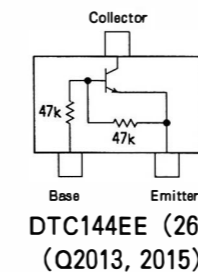
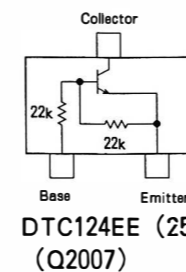
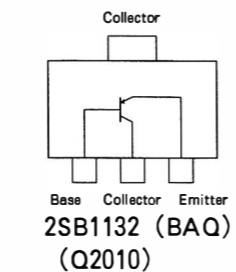
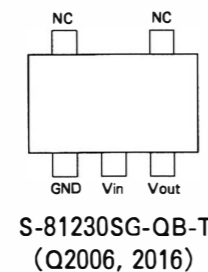
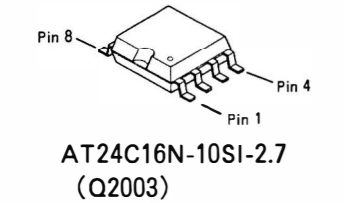
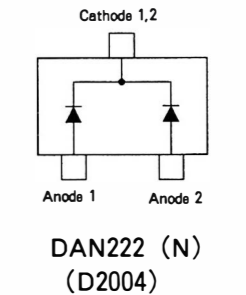
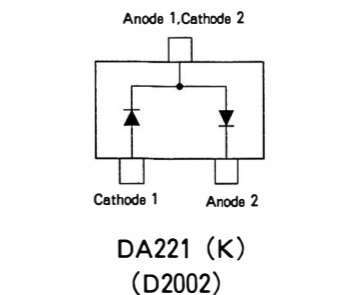
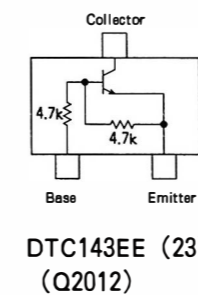
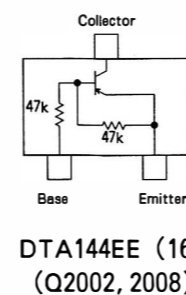
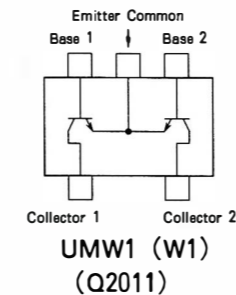
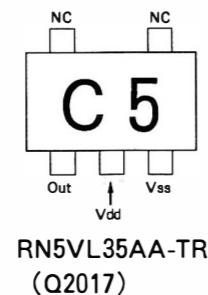
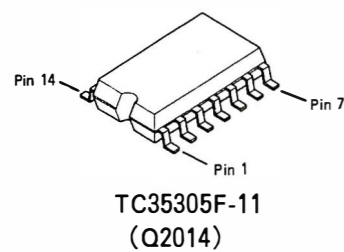
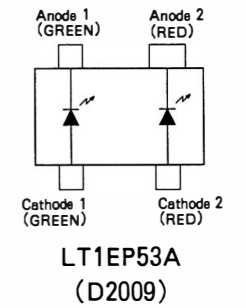
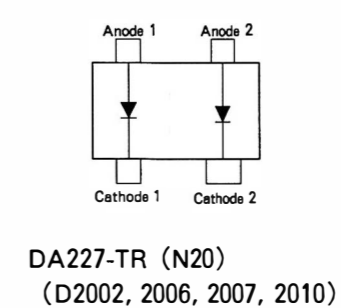
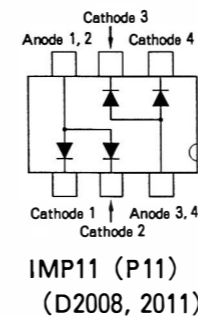
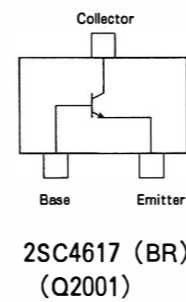
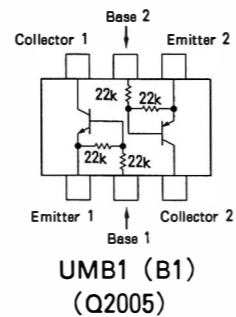
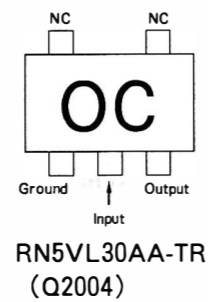
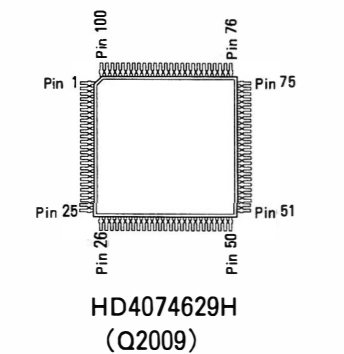



## Parts List

REF.	MFGR'S DESIG	VALUE	WV	TOL.	DESCRIPTION	YAESU P/N	VERS.
*** CNTL UNIT ***							
	PCB With Components					CA1084002	TYP A2
	PCB With Components					CA1084003	TYP A3
	PCB With Components					CA1084004	TYP B1
	PCB With Components					CA1084005	TYP B3
	PCB With Components					CA1084006	TYP H4
	Printed Circuit Board					F3403101A	
C 2001	CHIP CAP.	0.1uF	25V	B	GRM40B104M25PT	K22140811	
C 2003	CHIP CAP.	0.001uF	25V	B	TMK105B102K-F	K22148820	
C 2004	CHIP CAP.	0.001uF	25V	B	TMK105B102K-F	K22148820	
C 2005	CHIP CAP.	0.001uF	25V	B	TMK105B102K-F	K22148820	
C 2006	CHIP CAP.	0.001uF	25V	B	TMK105B102K-F	K22148820	
C 2007	CHIP CAP.	100pF	25V	CH	TMK105CH101J-F	K22148238	
C 2008	CHIP CAP.	0.1uF	25V	B	GRM40B104M25PT	K22140811	
C 2009	CHIP CAP.	100pF	25V	CH	TMK105CH101J-F	K22148238	
C 2010	CHIP CAP.	0.1uF	25V	B	GRM40B104M25PT	K22140811	
C 2011	TANTALUM CHIP CAP.	10uF	6.3V		TEMSVA0J106M-8R	K78080027	
C 2012	CHIP CAP.	0.001uF	25V	B	TMK105B102K-F	K22148820	
C 2013	CHIP CAP.	0.001uF	50V	B	GRM39B102M50PT	K22174809	
C 2014	TANTALUM CHIP CAP.	47uF	16V		TEMSVD21C476M12R	K78120027	
C 2015	TANTALUM CHIP CAP.	22uF	4V		TEMSVB20G226M-8R	K78060011	
C 2016	CHIP CAP.	0.01uF	16V	B	EMK105B103K-F	K22128802	
C 2017	CHIP CAP.	33pF	25V	CH	TMK105CH330J-F	K22148226	
C 2018	CHIP CAP.	33pF	25V	CH	TMK105CH330J-F	K22148226	
C 2019	TANTALUM CHIP CAP.	4.7uF	6.3V		TEMSVA0J475M-8R	K78080017	
C 2020	CHIP CAP.	33pF	25V	CH	TMK105CH330J-F	K22148226	
C 2021	CHIP CAP.	33pF	25V	CH	TMK105CH330J-F	K22148226	
C 2023	CHIP CAP.	0.01uF	16V	B	EMK105B103K-F	K22128802	
C 2024	CHIP CAP.	33pF	25V	CH	TMK105CH330J-F	K22148226	
C 2026	CHIP CAP.	0.01uF	16V	B	EMK105B103K-F	K22128802	
C 2027	CHIP CAP.	0.01uF	16V	B	EMK105B103K-F	K22128802	
C 2028	TANTALUM CHIP CAP.	150uF	4V		TEMSVD20G157M12R	K78060018	
C 2029	CHIP CAP.	0.001uF	25V	B	TMK105B102K-F	K22148820	
C 2030	CHIP CAP.	0.001uF	25V	B	TMK105B102K-F	K22148820	
C 2031	CHIP CAP.	0.001uF	50V	B	GRM39B102M50PT	K22174809	
C 2032	CHIP CAP.	220pF	16V	CH	EMK105CH221J-F	K22128208	
C 2033	CHIP CAP.	220pF	50V	CH	GRM39CH221J50PT	K22174243	
C 2034	CHIP CAP.	220pF	50V	CH	GRM39CH221J50PT	K22174243	
C 2035	CHIP CAP.	220pF	16V	CH	EMK105CH221J-F	K22128208	
C 2036	CHIP CAP.	220pF	50V	CH	GRM39CH221J50PT	K22174243	
C 2037	CHIP CAP.	220pF	16V	CH	EMK105CH221J-F	K22128208	
C 2038	CHIP CAP.	220pF	16V	CH	EMK105CH221J-F	K22128208	
C 2039	CHIP CAP.	220pF	16V	CH	EMK105CH221J-F	K22128208	
C 2040	CHIP CAP.	220pF	16V	CH	EMK105CH221J-F	K22128208	
C 2041	CHIP CAP.	0.047uF	25V	F	GRM39F473Z25PT	K22145002	
C 2042	CHIP CAP.	0.047uF	16V	F	EMK105F473Z-F	K22129002	
C 2043	CHIP CAP.	0.047uF	16V	F	EMK105F473Z-F	K22129002	
C 2044	CHIP CAP.	0.001uF	25V	B	TMK105B102K-F	K22148820	

# CNTL Unit

REF.	MFGR'S DESIG	VALUE	WV	TOL.	DESCRIPTION	YAESU P/N	VERS.
C 2045	CHIP CAP.	0.001uF	25V	B	TMK105B102K-F	K22148820	
C 2046	CHIP CAP.	0.001uF	25V	B	TMK105B102K-F	K22148820	
C02001	CERAMIC OSC				CSAC2.00MGC-TC	H7900800	
C02002	CERAMIC OSC				CSAC3.58MGC300A-TC	H7900790	
D 2001	LED				L1175	G2090575	
D 2002	DIODE				DA221 TL	G2070178	
D 2004	DIODE				DAN222 TL	G2070174	
D 2005	LED				CL-170G-CD-T	G2070226	
D 2006	DIODE				DA227-TR	G2070292	
D 2007	DIODE				DA227-TR	G2070292	
D 2008	DIODE				IMP11 T110	G2070120	
D 2009	LED				LT1EP53A	G2070066	
D 2010	DIODE				DA227-TR	G2070292	
D 2011	DIODE				IMP11 T110	G2070120	
D 2012	DIODE				MA729-(TX)	G2070320	
DS2001	LCD				LCM-218BS	G6090105	
J 2001	CONNECTOR				CPB8618-0551	P0091010	
J 2002	CONNECTOR				CPB8618-0551	P0091010	
J 2003	CONNECTOR				52204-1190	P1090808	
Q 2001	TRANSISTOR				2SC4617 TL R	G3346178R	
Q 2002	TRANSISTOR				DTA144EE TL	G3070074	
Q 2003	IC				AT24C16N-10SI-2.7	G1091743	
Q 2004	IC				RN5VL30AA-TR	G1091772	
Q 2005	TRANSISTOR				UMB1 TN	G3070097	
Q 2006	IC				S-81230SG-QB-T1	G1091826	
Q 2007	TRANSISTOR				DTC124EE TL	G3070109	
Q 2008	TRANSISTOR				DTA144EE TL	G3070074	
Q 2009	IC				HD4074629H HY-188	G1091819	TYP A2
Q 2009	IC				HD4074629H HY-188	G1091819	TYP A3
Q 2009	IC				HD4074629H HY-188	G1091819	TYP B1
Q 2009	IC				HD4074629H HY-188	G1091819	TYP B3
Q 2009	IC				HD4074629H HY-188	G1091819	TYP H4
Q 2010	TRANSISTOR				2SB1132 T100 Q	G3211327Q	
Q 2011	TRANSISTOR				UMW1 TR	G3070078	
Q 2012	TRANSISTOR				DTC143EE TL	G3070114	
Q 2013	TRANSISTOR				DTC144EE TL	G3070075	
Q 2014	IC				TC35305F-11 TP2	G1091177	
Q 2015	TRANSISTOR				DTC144EE TL	G3070075	
Q 2016	IC				S-81230SG-QB-T1	G1091826	
Q 2017	IC				RN5VL35AA-TR	G1091666	
R 2001	CHIP RES.	220K	1/16W	5%	RMC1/16S 224JTH	J24189053	
R 2002	CHIP RES.	150	1/16W	5%	RMC1/16S 151JTH	J24189015	
R 2003	CHIP RES.	100K	1/16W	5%	RMC1/16S 104JTH	J24189049	
R 2004	CHIP RES.	330K	1/16W	5%	RMC1/16S 334JTH	J24189055	
R 2005	CHIP RES.	100K	1/16W	5%	RMC1/16S 104JTH	J24189049	

# CNTL Unit

REF.	MFGR'S DESIG	VALUE	WV	TOL.	DESCRIPTION	YAESU P/N	VERS.
R 2007	CHIP RES.	150	1/16W	5%	RMC1/16S 151JTH	J24189015	
R 2008	CHIP RES.	220K	1/16W	5%	RMC1/16S 224JTH	J24189053	
R 2009	CHIP RES.	10K	1/16W	5%	RMC1/16S 103JTH	J24189037	
R 2011	CHIP RES.	10K	1/16W	5%	RMC1/16S 103JTH	J24189037	
R 2016	CHIP RES.	220K	1/16W	5%	RMC1/16S 224JTH	J24189053	
R 2017	CHIP RES.	100K	1/16W	5%	RMC1/16S 104JTH	J24189049	
R 2018	CHIP RES.	1M	1/16W	5%	RMC1/16S 105JTH	J24189061	
R 2019	CHIP RES.	10K	1/16W	5%	RMC1/16S 103JTH	J24189037	
R 2020	CHIP RES.	22K	1/16W	5%	RMC1/16S 223JTH	J24189041	
R 2021	CHIP RES.	56K	1/16W	5%	RMC1/16S 563JTH	J24189046	
R 2022	CHIP RES.	82K	1/16W	5%	RMC1/16S 823JTH	J24189048	
R 2023	CHIP RES.	1. 5K	1/16W	5%	RMC1/16S 152JTH	J24189027	
R 2024	CHIP RES.	18K	1/16W	5%	RMC1/16S 183JTH	J24189040	
R 2025	CHIP RES.	10K	1/16W	5%	RMC1/16S 103JTH	J24189037	
R 2026	CHIP RES.	390	1/16W	5%	RMC1/16 391JATP	J24185391	
R 2027	CHIP RES.	3. 3K	1/16W	5%	RMC1/16S 332JTH	J24189031	
R 2028	CHIP RES.	4. 7K	1/16W	5%	RMC1/16S 472JTH	J24189033	
R 2029	CHIP RES.	470	1/16W	5%	RMC1/16S 471JTH	J24189021	
R 2030	CHIP RES.	150	1/16W	5%	RMC1/16S 151JTH	J24189015	
R 2031	CHIP RES.	150	1/16W	5%	RMC1/16 151JATP	J24185151	
R 2032	CHIP RES.	100K	1/16W	5%	RMC1/16S 104JTH	J24189049	
R 2033	CHIP RES.	33K	1/16W	5%	RMC1/16S 333JTH	J24189043	
R 2034	CHIP RES.	10K	1/16W	5%	RMC1/16S 103JTH	J24189037	
R 2035	CHIP RES.	10K	1/16W	5%	RMC1/16S 103JTH	J24189037	
R 2037	CHIP RES.	0	1/16W	5%	RMC1/16 000JATP	J24185000	
S 2001	SLIDE SWITCH				SSSS8-12B-12	N6090093	
S 2002	TACT SWITCH				SKQDAA	N5090051	
S 2003	TACT SWITCH				SKQDAA	N5090051	
	LEAF SPRING					R0148860	
	METAL HOLDER					R0519500A	
	CONDUCTOR				0. 1X36X3. 1X1. 5	S2000046	



Circuit Diagram

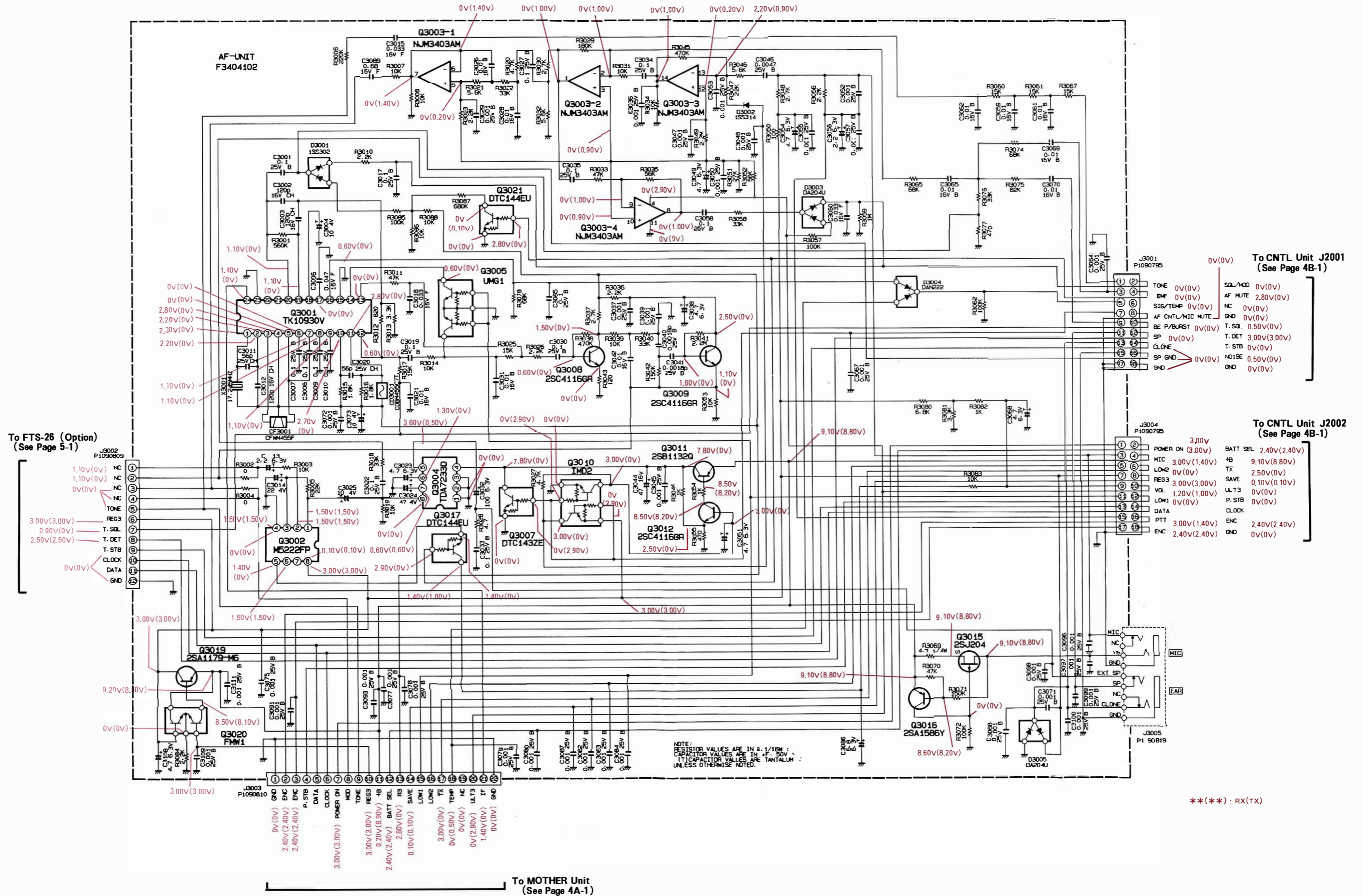





Parts Layout

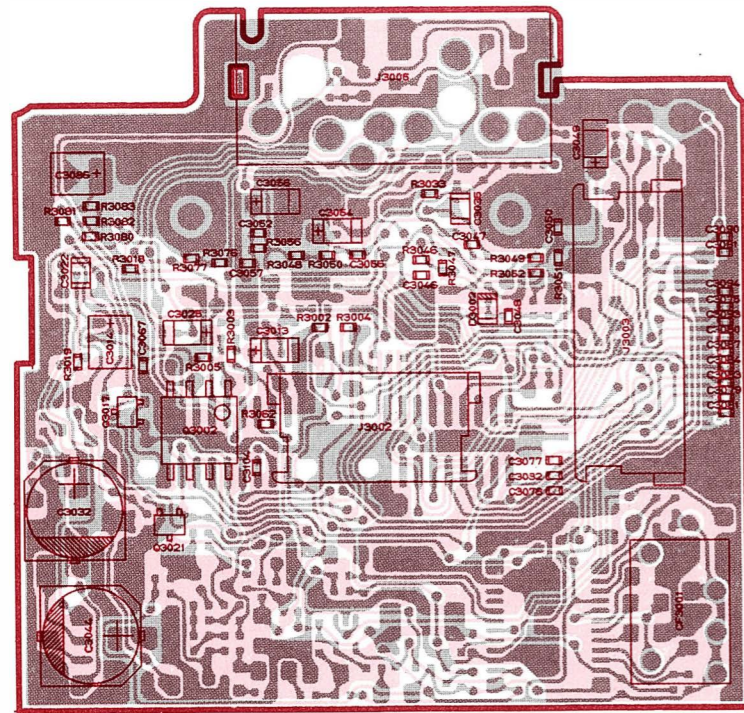

obverse view of component side

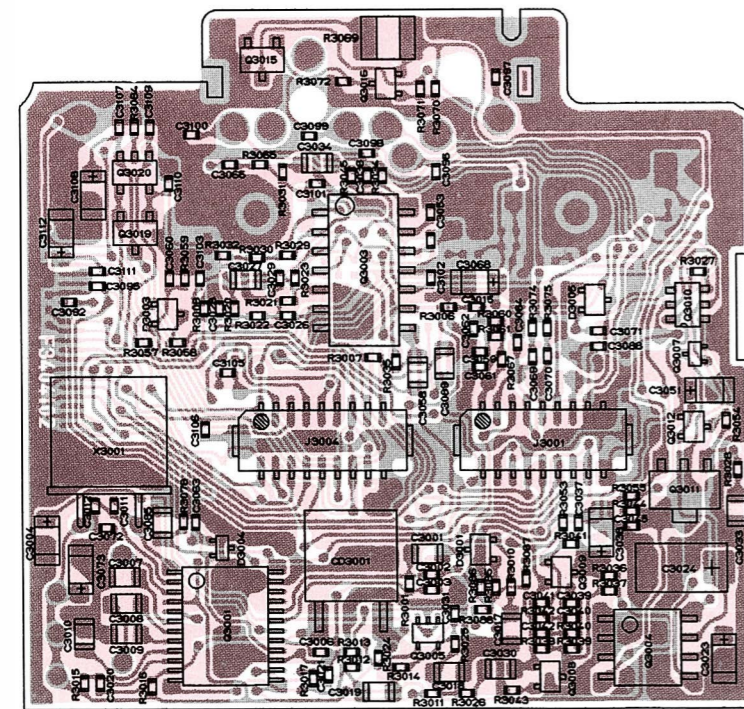

obverse view of chip side

To MOTHER Unit  
(See Page 4A-3)

- 1. GND
- 2. ENC
- 3. ENC
- 4. P.STB
- 5. DATA
- 6. CLOCK
- 7. POWER ON
- 8. MOD
- 9. TONE
- 10. REG3
- 11. +B
- 12. BATT SEL
- 13. R3
- 14. SAVE
- 15. LOW1
- 16. LOW2
- 17. TX
- 18. TEMP
- 19. NC
- 20. ULT3
- 21. IF
- 22. GND

To FTS-26 (Option)  
(See Page 5-1)

- 1. NC
- 2. NC
- 3. NC
- 4. TONE
- 5. REG3
- 6. T.SOL
- 7. T.DET
- 8. F.CLOCK
- 9. F.CLOCK
- 10. DATA
- 11. DATA
- 12. GND

J3001  
To CNTL Unit J2001  
(See Page 4B-3)

- 2. SOL/ MOD
- 3. TONE
- 4. AF MUTE
- 5. SIG/TEMP
- 6. NC
- 7. AF CNTL/ MIC MUTE
- 8. GND
- 9. BEEP/ BURST
- 10. T.SOL
- 11. SP
- 12. T.DET
- 13. CLONE
- 14. T.STB
- 15. SP GND
- 16. NOISE
- 17. GND
- 18. GND

J3004  
To CNTL Unit J2002  
(See Page 4B-3)

- 1. POWER ON
- 2. MIC
- 3. LOW2
- 4. REG3
- 5. VOL
- 6. P.STB
- 7. DATA
- 8. ENC
- 9. PTT
- 10. GND
- 11. ENC

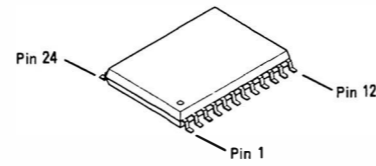

TK10930VT1  
(Q3001)

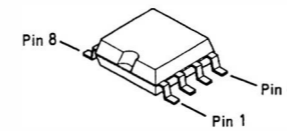

TDA7233D-TR  
(Q3004)

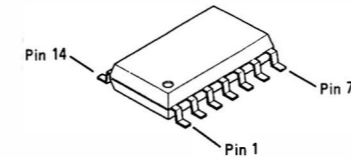

NJM3403AM  
(Q3003)

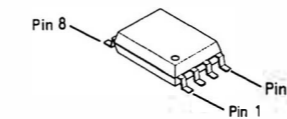

M5222FP-600C  
(Q3002)

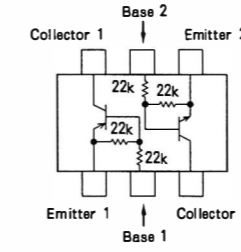

IMD2 (D2)  
(Q3010)

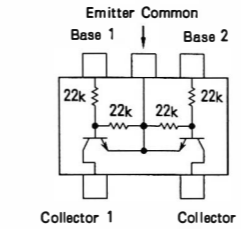

UMG1 (G1)  
(Q3005)

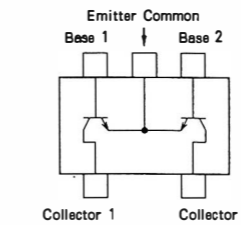

FMW1 (W1)  
(Q3020)

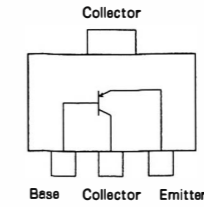

2SB1132 (BAQ)  
(Q3011)

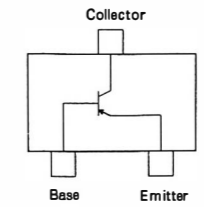

2SA1179 (M6)  
(Q3019)  
2SA1586Y (SY)  
(Q3016)

2SC4116GR  
(Q3008, 3009, 3012)

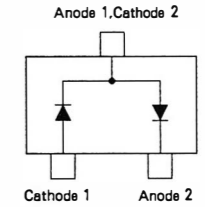

DA204U (K)  
(D3003, 3005)

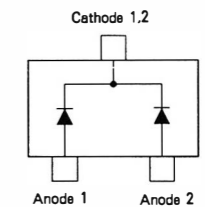

DAN222 (N)  
(D3004)

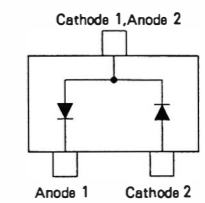

1SS302 (C3)  
(D3001)

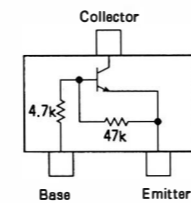

DTC143ZE (E23)  
(Q3007)

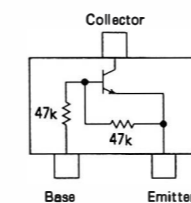

DTC144EU (26)  
(Q3017, 3021)

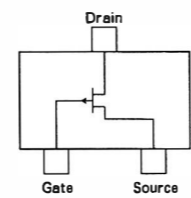

2SJ204  
(Q3015)



## Parts List

REF.	MFGR'S DESIG	VALUE	WV	TOL.	DESCRIPTION	YAESU P/N	VERS.
*** AF UNIT ***							
	PCB With Components					CA1021001	
	Printed Circuit Board					F3404102	
C 3001	CHIP CAP.	0.1uF	25V	B	GRM40B104M25PT	K22140811	
C 3002	CHIP CAP.	100pF	25V	CH	TMK105CH101J-F	K22148238	
C 3003	CHIP CAP.	100pF	25V	CH	TMK105CH101J-F	K22148238	
C 3004	TANTALUM CHIP CAP.	10uF	6.3V		TEMSVAOJ106M-8R	K78080027	
C 3006	CHIP CAP.	0.047uF	16V	F	EMK105F473Z-F	K22129002	
C 3007	CHIP CAP.	0.1uF	25V	B	GRM40B104M25PT	K22140811	
C 3008	CHIP CAP.	0.1uF	25V	B	GRM40B104M25PT	K22140811	
C 3009	CHIP CAP.	0.1uF	25V	B	GRM40B104M25PT	K22140811	
C 3010	CHIP CAP.	0.1uF	25V	B	GRM40B104M25PT	K22140811	
C 3011	CHIP CAP.	56pF	25V	CH	TMK105CH560J-F	K22148232	
C 3012	CHIP CAP.	120pF	16V	CH	EMK105CH121J-F	K22128202	
C 3013	TANTALUM CHIP CAP.	2.2uF	6.3V		TESVAOJ225M1-8R	K78080009	
C 3014	TANTALUM CHIP CAP.	22uF	4V		TEMSVB20G226M-8R	K78060011	
C 3015	CHIP CAP.	0.033uF	16V	F	EMK105F333Z-F	K22129001	
C 3017	CHIP CAP.	0.047uF	50V	B	GRM40B473M50PT	K22170823	
C 3018	CHIP CAP.	0.033uF	25V	B	GRM40B333M25PT	K22140810	
C 3019	CHIP CAP.	0.1uF	25V	B	GRM40B104M25PT	K22140811	
C 3020	CHIP CAP.	82pF	25V	CH	TMK105CH820J-F	K22148236	
C 3021	CHIP CAP.	0.01uF	16V	B	EMK105B103K-F	K22128802	
C 3022	CHIP CAP.	0.1uF	25V	B	GRM40B104M25PT	K22140811	
C 3023	TANTALUM CHIP CAP.	4.7uF	6.3V		TEMSVAOJ475M-8R	K78080017	
C 3024	TANTALUM CHIP CAP.	10uF	20V		TEMSVC1D106M12R	K78130016	
C 3025	TANTALUM CHIP CAP.	10uF	6.3V		TEMSVAOJ106M-8R	K78080027	
C 3026	CHIP CAP.	0.01uF	16V	B	EMK105B103K-F	K22128802	
C 3027	CHIP CAP.	1uF	16V	F	EMK212F105Z00T	K22121001	
C 3028	CHIP CAP.	0.01uF	16V	B	EMK105B103K-F	K22128802	
C 3029	CHIP CAP.	0.001uF	25V	B	TMK105B102K-F	K22148820	
C 3030	CHIP CAP.	0.1uF	25V	B	GRM40B104M25PT	K22140811	
C 3031	CHIP CAP.	0.01uF	16V	B	EMK105B103K-F	K22128802	
C 3032	AL. ELECTRO. CAP.	100uF	6.3V		ECEVOJA101P	K48080002	
C 3033	CHIP CAP.	0.1uF	25V	B	GRM40B104M25PT	K22140811	
C 3034	CHIP CAP.	1uF	16V	F	EMK212F105Z00T	K22121001	
C 3035	CHIP CAP.	0.1uF	25V	B	GRM40B104M25PT	K22140811	
C 3036	CHIP CAP.	0.001uF	25V	B	TMK105B102K-F	K22148820	
C 3037	CHIP CAP.	0.001uF	25V	B	TMK105B102K-F	K22148820	
C 3038	TANTALUM CHIP CAP.	4.7uF	6.3V		TEMSVAOJ475M-8R	K78080017	
C 3039	CHIP CAP.	0.001uF	25V	B	TMK105B102K-F	K22148820	
C 3040	CHIP CAP.	0.0018pF	25V	B	TMK105B182K-F	K22148823	
C 3041	CHIP CAP.	0.0018pF	25V	B	TMK105B182K-F	K22148823	
C 3042	CHIP CAP.	0.01uF	16V	B	EMK105B103K-F	K22128802	
C 3044	AL. ELECTRO. CAP.	47uF	16V		ECEV1CA470SP	K48120005	
C 3045	CHIP CAP.	0.001uF	25V	B	TMK105B102K-F	K22148820	
C 3046	CHIP CAP.	0.0047uF	25V	B	TMK105B472K-F	K22148801	
C 3047	CHIP CAP.	0.001uF	25V	B	TMK105B102K-F	K22148820	
C 3048	CHIP CAP.	0.001uF	25V	B	TMK105B102K-F	K22148820	

# AF Unit

REF.	MFGR'S DESIG	VALUE	WV	TOL.	DESCRIPTION	YAESU P/N	VERS.
C 3049	TANTALUM CHIP CAP.	4.7uF	6.3V		TEMSVAOJ475M-8R	K78080017	
C 3050	CHIP CAP.	0.001uF	25V	B	TMK105B102K-F	K22148820	
C 3051	TANTALUM CHIP CAP.	4.7uF	6.3V		TEMSVAOJ475M-8R	K78080017	
C 3052	CHIP CAP.	0.001uF	25V	B	TMK105B102K-F	K22148820	
C 3053	CHIP CAP.	0.001uF	25V	B	TMK105B102K-F	K22148820	
C 3054	TANTALUM CHIP CAP.	10uF	6.3V		TEMSVAOJ106M-8R	K78080027	
C 3055	CHIP CAP.	0.001uF	25V	B	TMK105B102K-F	K22148820	
C 3056	TANTALUM CHIP CAP.	2.2uF	6.3V		TESVAOJ225M1-8R	K78080009	
C 3057	CHIP CAP.	0.001uF	25V	B	TMK105B102K-F	K22148820	
C 3058	CHIP CAP.	0.1uF	25V	B	GRM40B104M25PT	K22140811	
C 3059	CHIP CAP.	0.01uF	16V	B	EMK105B103K-F	K22128802	
C 3060	CHIP CAP.	0.033uF	16V	F	EMK105F333Z-F	K22129001	
C 3061	CHIP CAP.	0.01uF	16V	B	EMK105B103K-F	K22128802	
C 3062	CHIP CAP.	0.01uF	16V	B	EMK105B103K-F	K22128802	
C 3064	CHIP CAP.	0.001uF	25V	B	TMK105B102K-F	K22148820	
C 3065	CHIP CAP.	0.01uF	16V	B	EMK105B103K-F	K22128802	
C 3067	CHIP CAP.	0.001uF	25V	B	TMK105B102K-F	K22148820	
C 3068	TANTALUM CHIP CAP.	4.7uF	6.3V		TEMSVAOJ475M-8R	K78080017	
C 3069	CHIP CAP.	0.01uF	16V	B	EMK105B103K-F	K22128802	
C 3070	CHIP CAP.	0.01uF	16V	B	EMK105B103K-F	K22128802	
C 3071	CHIP CAP.	0.001uF	25V	B	TMK105B102K-F	K22148820	
C 3072	CHIP CAP.	0.001uF	25V	B	TMK105B102K-F	K22148820	
C 3073	TANTALUM CHIP CAP.	10uF	6.3V		TEMSVAOJ106M-8R	K78080027	
C 3075	CHIP CAP.	0.001uF	25V	B	TMK105B102K-F	K22148820	
C 3077	CHIP CAP.	0.001uF	25V	B	TMK105B102K-F	K22148820	
C 3078	CHIP CAP.	0.001uF	25V	B	TMK105B102K-F	K22148820	
C 3079	CHIP CAP.	0.001uF	25V	B	TMK105B102K-F	K22148820	
C 3080	CHIP CAP.	0.001uF	25V	B	TMK105B102K-F	K22148820	
C 3082	CHIP CAP.	0.001uF	25V	B	TMK105B102K-F	K22148820	
C 3083	CHIP CAP.	0.001uF	25V	B	TMK105B102K-F	K22148820	
C 3084	CHIP CAP.	0.001uF	25V	B	TMK105B102K-F	K22148820	
C 3085	CHIP CAP.	0.1uF	25V	B	GRM40B104M25PT	K22140811	
C 3086	TANTALUM CHIP CAP.	6.8uF	6.3V		TEMSVAOJ685M-8R	K78080025	
C 3087	CHIP CAP.	0.001uF	25V	B	TMK105B102K-F	K22148820	
C 3088	CHIP CAP.	0.001uF	25V	B	TMK105B102K-F	K22148820	
C 3089	TANTALUM CHIP CAP.	6.8uF	6.3V		TEMSVAOJ685M-8R	K78080025	
C 3091	CHIP CAP.	0.001uF	25V	B	TMK105B102K-F	K22148820	
C 3093	CHIP CAP.	0.001uF	25V	B	TMK105B102K-F	K22148820	
C 3096	CHIP CAP.	0.001uF	25V	B	TMK105B102K-F	K22148820	
C 3097	CHIP CAP.	0.001uF	25V	B	TMK105B102K-F	K22148820	
C 3098	CHIP CAP.	0.001uF	25V	B	TMK105B102K-F	K22148820	
C 3099	CHIP CAP.	0.001uF	25V	B	TMK105B102K-F	K22148820	
C 3100	CHIP CAP.	0.001uF	25V	B	TMK105B102K-F	K22148820	
C 3108	TANTALUM CHIP CAP.	4.7uF	6.3V		TEMSVAOJ475M-8R	K78080017	
C 3109	CHIP CAP.	0.001uF	25V	B	TMK105B102K-F	K22148820	
C 3111	CHIP CAP.	0.001uF	25V	B	TMK105B102K-F	K22148820	
C 3113	CHIP CAP.	0.001uF	50V	B	GRM39B102M50PT	K22174809	
C 3114	CERAMIC CAP.	0.001uF	50V	B	UPO50B102K-A-B	K28179001	
C 3115	CHIP CAP.	0.1uF	25V	B	GRM40B104M25PT	K22140811	
CD3001	CERAMIC DISC				CDBM455C7T	H7900910	

REF.	MFGR'S DESIG	VALUE	WV	TOL.	DESCRIPTION	YAESU P/N	VERS.
CF3001	CERAMIC FILTER				CFWM455F	H3900395	
D 3001	DIODE				1SS302 TE85R	G2070088	
D 3002	DIODE				1SS314 TPH3	G2070122	
D 3003	DIODE				DA204U T106	G2070242	
D 3004	DIODE				DAN222 TL	G2070174	
D 3005	DIODE				DA204U T106	G2070242	
J 3001	CONNECTOR				CPB8518-0151	P1090795	
J 3002	CONNECTOR				52204-1290	P1090809	
J 3003	CONNECTOR				52204-2290	P1090810	
J 3004	CONNECTOR				CPB8518-0151	P1090795	
J 3005	CONNECTOR				HSJ1468-01-110	P1090819	
Q 3001	IC				TK10930VT1	G1091606	
Q 3002	IC				M5222FP-600C	G1091604	
Q 3003	IC				NJM3403AM-T1	G1091814	
Q 3004	IC				TDA7233D-TR	G1091112	
Q 3005	TRANSISTOR				UMG1 TR	G3070113	
Q 3007	TRANSISTOR				DTC143ZE TL	G3070102	
Q 3008	TRANSISTOR				2SC4116GR TE85R	G3341167G	
Q 3009	TRANSISTOR				2SC4116GR TE85R	G3341167G	
Q 3010	TRANSISTOR				IMD2 T108	G3070026	
Q 3011	TRANSISTOR				2SB1132 T100 Q	G3211327Q	
Q 3012	TRANSISTOR				2SC4116GR TE85R	G3341167G	
Q 3015	FET				2SJ204-T1B	G3702048	
Q 3016	TRANSISTOR				2SA1586Y TE85R	G3115867Y	
Q 3017	TRANSISTOR				DTC144EU T107	G3070041	
Q 3019	TRANSISTOR				2SA1179M6-TA	G3111797F	
Q 3020	TRANSISTOR				FMW1 T98	G3070009	
Q 3021	TRANSISTOR				DTC144EU T107	G3070041	
R 3001	CHIP RES.	820K	1/16W	5%	RMC1/16S 824JTH	J24189060	
R 3002	CHIP RES.	0	1/16W		RMC1/16S JPTH	J24189070	
R 3003	CHIP RES.	10K	1/16W	5%	RMC1/16S 103JTH	J24189037	
R 3004	CHIP RES.	0	1/16W		RMC1/16S JPTH	J24189070	
R 3005	CHIP RES.	22K	1/16W	5%	RMC1/16S 223JTH	J24189041	
R 3006	CHIP RES.	220K	1/16W	5%	RMC1/16S 224JTH	J24189053	
R 3007	CHIP RES.	10K	1/16W	5%	RMC1/16S 103JTH	J24189037	
R 3008	CHIP RES.	10K	1/16W	5%	RMC1/16S 103JTH	J24189037	
R 3010	CHIP RES.	6. 8K	1/16W	5%	RMC1/16S 682JTH	J24189035	
R 3011	CHIP RES.	47K	1/16W	5%	RMC1/16S 473JTH	J24189045	
R 3012	CHIP RES.	3. 3K	1/16W	5%	RMC1/16S 332JTH	J24189031	
R 3013	CHIP RES.	1. 5K	1/16W	5%	RMC1/16S 152JTH	J24189027	
R 3014	CHIP RES.	10K	1/16W	5%	RMC1/16S 103JTH	J24189037	
R 3015	CHIP RES.	2. 2K	1/16W	5%	RMC1/16S 222JTH	J24189029	
R 3016	CHIP RES.	3. 3K	1/16W	5%	RMC1/16S 332JTH	J24189031	
R 3017	CHIP RES.	10K	1/16W	5%	RMC1/16S 103JTH	J24189037	
R 3018	CHIP RES.	33K	1/16W	5%	RMC1/16S 333JTH	J24189043	
R 3019	CHIP RES.	10K	1/16W	5%	RMC1/16S 103JTH	J24189037	

# AF Unit

REF.	MFGR'S DESIG	VALUE	WV	TOL.	DESCRIPTION	YAESU P/N	VERS.
R 3020	CHIP RES.	4.7K	1/16W	5%	RMC1/16S 472JTH	J24189033	
R 3021	CHIP RES.	5.6K	1/16W	5%	RMC1/16S 562JTH	J24189034	
R 3022	CHIP RES.	33K	1/16W	5%	RMC1/16S 333JTH	J24189043	
R 3023	CHIP RES.	2.2M	1/16W		RMC1/16S 225JTH	J24189065	
R 3025	CHIP RES.	15K	1/16W	5%	RMC1/16S 153JTH	J24189039	
R 3026	CHIP RES.	2.2K	1/16W	5%	RMC1/16S 222JTH	J24189029	
R 3027	CHIP RES.	4.7K	1/16W	5%	RMC1/16S 472JTH	J24189033	
R 3028	CHIP RES.	4.7	1/16W		RMC1/16S 4R7JTH	J24189066	
R 3029	CHIP RES.	180K	1/16W	5%	RMC1/16S 184JTH	J24189052	
R 3030	CHIP RES.	5.6K	1/16W	5%	RMC1/16S 562JTH	J24189034	
R 3031	CHIP RES.	10K	1/16W	5%	RMC1/16S 103JTH	J24189037	
R 3032	CHIP RES.	5.6K	1/16W	5%	RMC1/16S 562JTH	J24189034	
R 3033	CHIP RES.	47K	1/16W	5%	RMC1/16S 473JTH	J24189045	
R 3034	CHIP RES.	10K	1/16W	5%	RMC1/16S 103JTH	J24189037	
R 3035	CHIP RES.	56K	1/16W	5%	RMC1/16S 563JTH	J24189046	
R 3036	CHIP RES.	2.2K	1/16W	5%	RMC1/16S 222JTH	J24189029	
R 3037	CHIP RES.	2.7K	1/16W	5%	RMC1/16S 272JTH	J24189030	
R 3038	CHIP RES.	470K	1/16W	5%	RMC1/16S 474JTH	J24189057	
R 3039	CHIP RES.	10K	1/16W	5%	RMC1/16S 103JTH	J24189037	
R 3040	CHIP RES.	33K	1/16W	5%	RMC1/16S 333JTH	J24189043	
R 3041	CHIP RES.	2.2M	1/16W		RMC1/16S 225JTH	J24189065	
R 3042	CHIP RES.	150K	1/16W	5%	RMC1/16S 154JTH	J24189051	
R 3043	CHIP RES.	120	1/16W	5%	RMC1/16S 121JTH	J24189014	
R 3044	CHIP RES.	1K	1/16W	5%	RMC1/16S 102JTH	J24189025	
R 3045	CHIP RES.	470K	1/16W	5%	RMC1/16S 474JTH	J24189057	
R 3046	CHIP RES.	5.6K	1/16W	5%	RMC1/16S 562JTH	J24189034	
R 3047	CHIP RES.	22K	1/16W	5%	RMC1/16S 223JTH	J24189041	
R 3048	CHIP RES.	2.7K	1/16W	5%	RMC1/16S 272JTH	J24189030	
R 3049	CHIP RES.	2.2M	1/16W		RMC1/16S 225JTH	J24189065	
R 3050	CHIP RES.	100	1/16W	5%	RMC1/16S 101JTH	J24189013	
R 3051	CHIP RES.	33K	1/16W	5%	RMC1/16S 333JTH	J24189043	
R 3052	CHIP RES.	56K	1/16W	5%	RMC1/16S 563JTH	J24189046	
R 3053	CHIP RES.	10K	1/16W	5%	RMC1/16S 103JTH	J24189037	
R 3054	CHIP RES.	1K	1/16W	5%	RMC1/16S 102JTH	J24189025	
R 3055	CHIP RES.	470	1/16W	5%	RMC1/16S 471JTH	J24189021	
R 3056	CHIP RES.	2.2K	1/16W	5%	RMC1/16S 222JTH	J24189029	
R 3057	CHIP RES.	100K	1/16W	5%	RMC1/16S 104JTH	J24189049	
R 3058	CHIP RES.	33K	1/16W	5%	RMC1/16S 333JTH	J24189043	
R 3059	CHIP RES.	220K	1/16W	5%	RMC1/16S 224JTH	J24189053	
R 3060	CHIP RES.	15K	1/16W	5%	RMC1/16S 153JTH	J24189039	
R 3061	CHIP RES.	15K	1/16W	5%	RMC1/16S 153JTH	J24189039	
R 3062	CHIP RES.	100K	1/16W	5%	RMC1/16S 104JTH	J24189049	
R 3065	CHIP RES.	56K	1/16W	5%	RMC1/16S 563JTH	J24189046	
R 3067	CHIP RES.	15K	1/16W	5%	RMC1/16S 153JTH	J24189039	
R 3069	CHIP RES.	4.7	1/4W	5%	RMC1/4 4R7JATP	J24245479	
R 3070	CHIP RES.	47K	1/16W	5%	RMC1/16S 473JTH	J24189045	
R 3071	CHIP RES.	150K	1/16W	5%	RMC1/16S 154JTH	J24189051	
R 3072	CHIP RES.	100K	1/16W	5%	RMC1/16S 104JTH	J24189049	
R 3074	CHIP RES.	56K	1/16W	5%	RMC1/16S 563JTH	J24189046	
R 3075	CHIP RES.	82K	1/16W	5%	RMC1/16S 823JTH	J24189048	
R 3076	CHIP RES.	33K	1/16W	5%	RMC1/16S 333JTH	J24189043	

REF.	MFGR'S DESIG	VALUE	WV	TOL.	DESCRIPTION	YAESU P/N	VERS.
R 3077	CHIP RES.	1K	1/16W	5%	RMC1/16S 102JTH	J24189025	
R 3078	CHIP RES.	68K	1/16W	5%	RMC1/16S 683JTH	J24189047	
R 3080	CHIP RES.	5.6K	1/16W	5%	RMC1/16S 562JTH	J24189034	
R 3081	CHIP RES.	3.3K	1/16W	5%	RMC1/16S 332JTH	J24189031	
R 3082	CHIP RES.	1K	1/16W	5%	RMC1/16S 102JTH	J24189025	
R 3083	CHIP RES.	10K	1/16W	5%	RMC1/16S 103JTH	J24189037	
R 3084	CHIP RES.	2.2K	1/16W	5%	RMC1/16S 222JTH	J24189029	
R 3085	CHIP RES.	22K	1/16W	5%	RMC1/16S 223JTH	J24189041	
R 3086	CHIP RES.	10K	1/16W	5%	RMC1/16S 103JTH	J24189037	
R 3087	CHIP RES.	33K	1/16W	5%	RMC1/16S 333JTH	J24189043	
R 3088	CHIP RES.	6.8K	1/16W	5%	RMC1/16S 682JTH	J24189035	
R 3089	CHIP RES.	0	1/16W	5%	RMC1/16 000JATP	J24185000	
X 3001	XTAL	17.245MHz				H0102986	





## Circuit Diagram

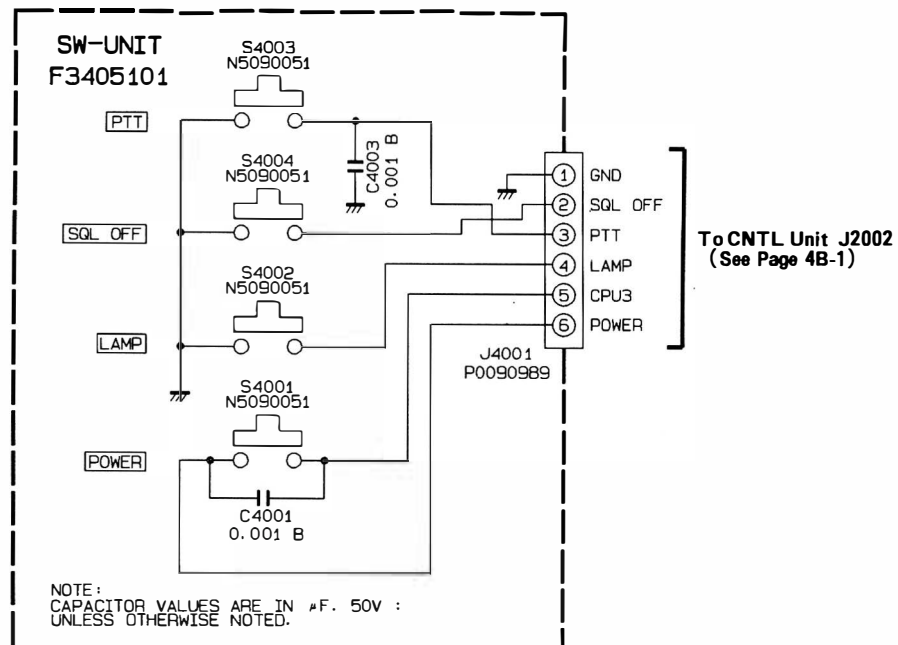

## Parts Layout

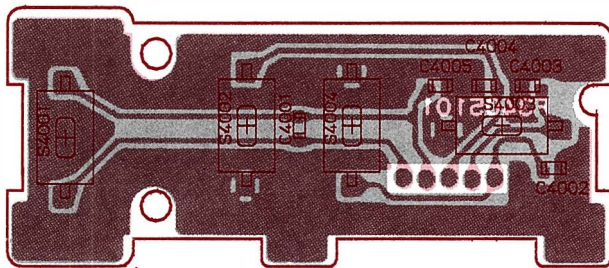

obverse view of component side

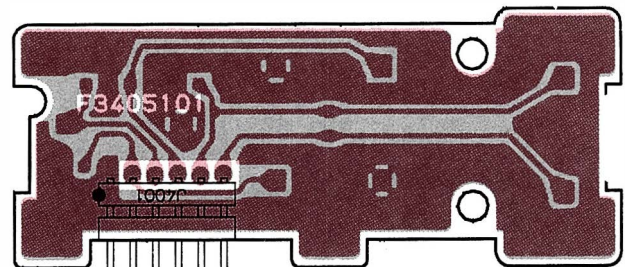

obverse view of connector side

1. GND  
2. SQL OFF  
3. PTT  
4. LAMP  
5. CPU3  
6. POWER

## Parts List

REF.	MFGR'S DESIG	VALUE	WV	TOL.	DESCRIPTION	YAESU P/N	VERS.
*** SW UNIT ***							
	PCB With Components					CA1089001	
	Printed Circuit Board					F3405101	
C 4001	CHIP CAP.	0.001uF	50V	B	GRM39B102M50PT	K22174809	
C 4003	CHIP CAP.	0.001uF	50V	B	GRM39B102M50PT	K22174809	
J 4001	CONNECTOR				9230B-1-06Z055-T	P0090989	
S 4001	TACT SWITCH				SKQDAA	N5090051	
S 4002	TACT SWITCH				SKQDAA	N5090051	
S 4003	TACT SWITCH				SKQDAA	N5090051	
S 4004	TACT SWITCH				SKQDAA	N5090051	



## Circuit Diagram

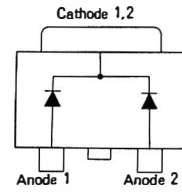
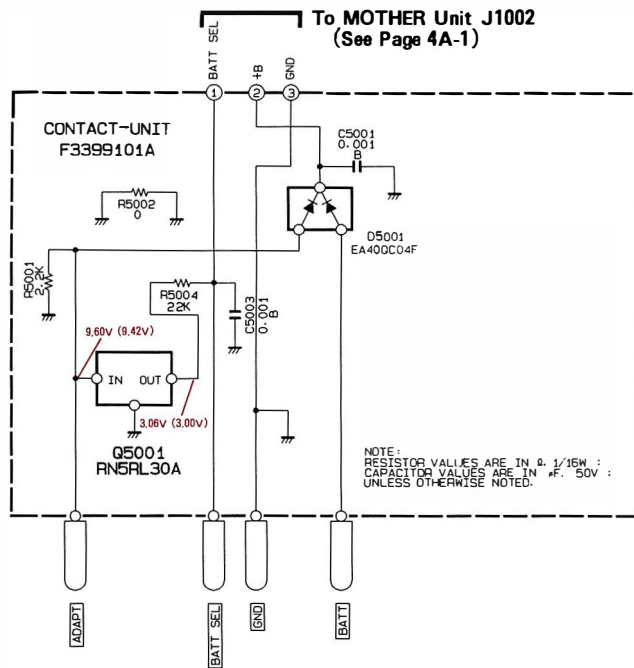

EA40QC04F  
(D5001)

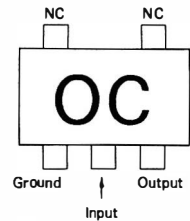

RN5RL30AA-TR (OC)  
(Q5001)

## Parts Layout

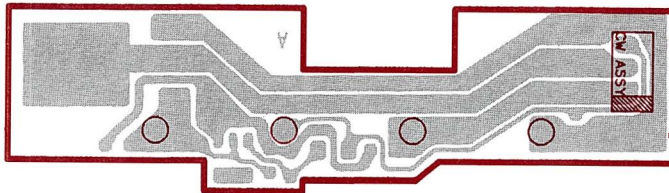

- 3. GND
- 2. +B
- 1. BATT SEL

obverse view of wire ass'y side

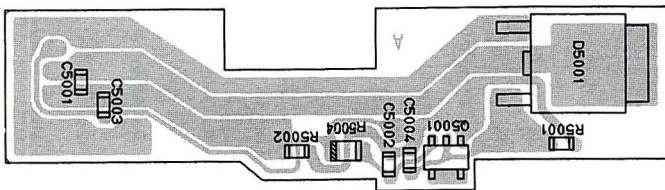

obverse view of chip side

## Parts List

REF.	MFGR'S DESIG	VALUE	WV	TOL.	DESCRIPTION	YAESU P/N	VERS.
*** CONTACT UNIT ***							
	PCB With Components					CA1134001	
	Printed Circuit Board					F3399101A	
C 5001	CHIP CAP.	0.001uF	50V	B	GRM39B102M50PT	K22174809	
C 5002	CHIP CAP.	0.001uF	50V	B	GRM39B102M50PT	K22174809	
C 5003	CHIP CAP.	0.001uF	50V	B	GRM39B102M50PT	K22174809	
C 5004	CHIP CAP.	0.001uF	50V	B	GRM39B102M50PT	K22174809	
D 5001	DIODE				EA40QC04F TE16F3	G2070206	
Q 5001	IC				RN5RL30AA-TR	G1091646	
R 5001	CHIP RES.	2.2K	1/16W	5%	RMC1/16 222JATP	J24185222	
R 5002	CHIP RES.	0	1/16W	5%	RMC1/16 000JATP	J24185000	
R 5004	CHIP RES.	22K	1/10W	5%	RMC1/10T 223J	J24205223	
	WIRE ASSY					T9206298	



## Circuit Diagram

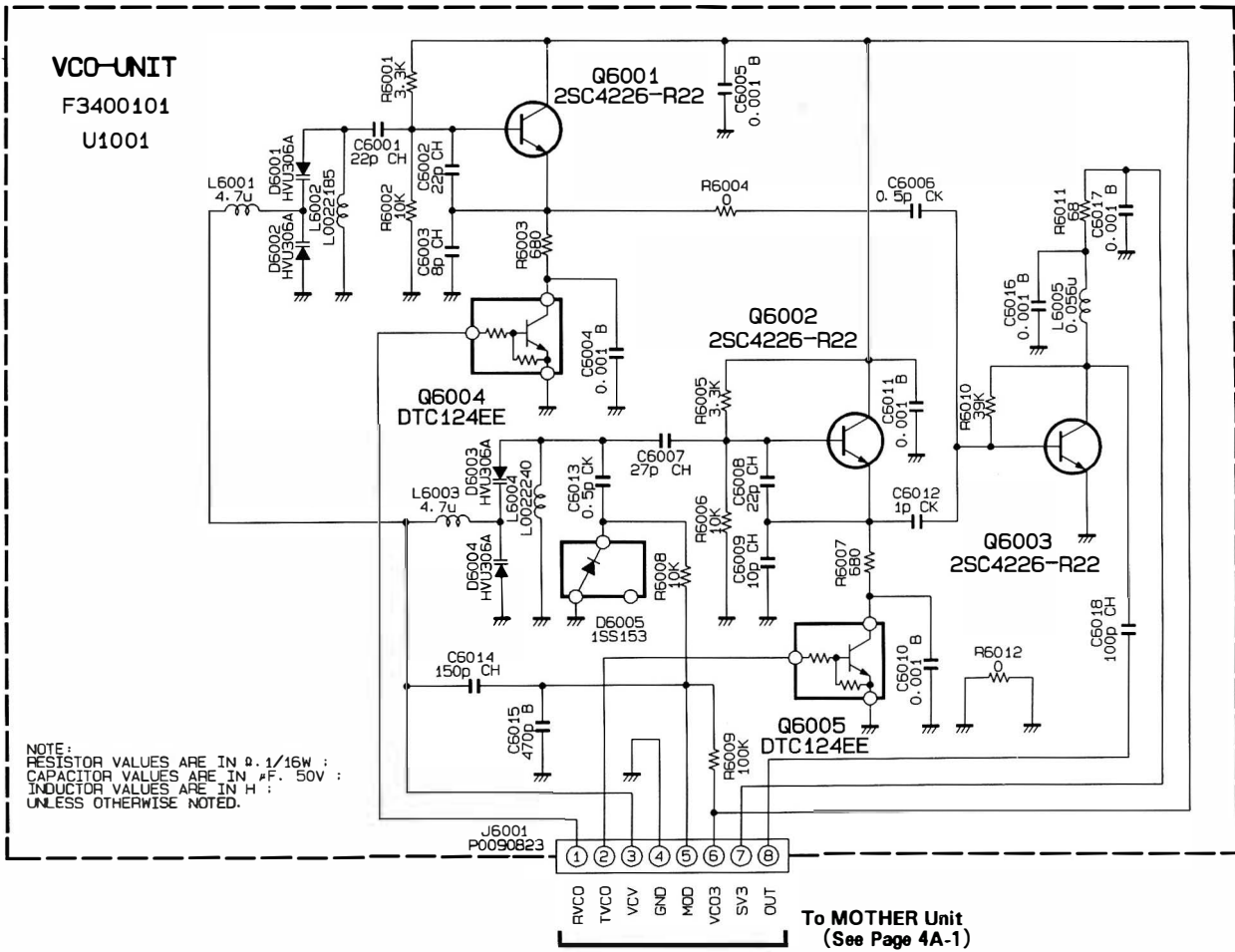

## Parts Layout

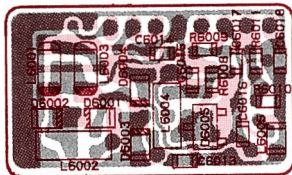

obverse view of chip side

- 8. OUT
- 7. SV3
- 6. VCO3
- 5. MOD
- 4. GND
- 3. VCV
- 2. TVCO
- 1. RVCO

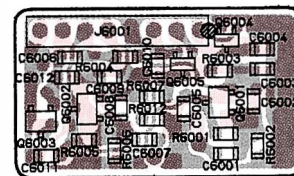

obverse view of connector side

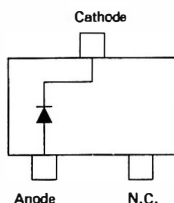

1SS153 (A9)  
(D6005)

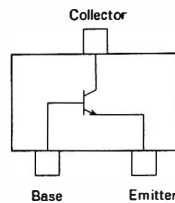

2SC4226 (R22)  
(Q6001, 6002, 6003)

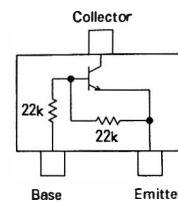

DTC124EE (25)  
(Q6004, 6005)



## Parts List

REF.	MFGR'S DESIG	VALUE	WV	TOL.	DESCRIPTION	YAESU P/N	VERS.
*** VCO UNIT ***							
	PCB With Components					CA1091001	
	Printed Circuit Board					F3400101	
C 6001	CHIP CAP.	22pF	50V	CH	GRM39CH220J50PT	K22174219	
C 6002	CHIP CAP.	22pF	50V	CH	GRM39CH220J50PT	K22174219	
C 6003	CHIP CAP.	8pF	50V	CH	GRM39CH080D50PT	K22174209	
C 6004	CHIP CAP.	0.001uF	50V	B	GRM39B102M50PT	K22174809	
C 6005	CHIP CAP.	0.001uF	50V	B	GRM39B102M50PT	K22174809	
C 6006	CHIP CAP.	0.5pF	50V	CK	GRM39CK0R5C50PT	K22174201	
C 6007	CHIP CAP.	27pF	50V	CH	GRM39CH270J50PT	K22174221	
C 6008	CHIP CAP.	22pF	50V	CH	GRM39CH220J50PT	K22174219	
C 6009	CHIP CAP.	10pF	50V	CH	GRM39CH100D50PT	K22174211	
C 6010	CHIP CAP.	0.001uF	50V	B	GRM39B102M50PT	K22174809	
C 6011	CHIP CAP.	0.001uF	50V	B	GRM39B102M50PT	K22174809	
C 6012	CHIP CAP.	1pF	50V	CK	GRM39CK010C50PT	K22174202	
C 6013	CHIP CAP.	0.5pF	50V	CK	GRM39CK0R5C50PT	K22174201	
C 6014	CHIP CAP.	150pF	50V	CH	GRM39CH151J50PT	K22174239	
C 6015	CHIP CAP.	470pF	50V	B	GRM39B471M50PT	K22174805	
C 6016	CHIP CAP.	0.001uF	50V	B	GRM39B102M50PT	K22174809	
C 6017	CHIP CAP.	0.001uF	50V	B	GRM39B102M50PT	K22174809	
C 6018	CHIP CAP.	100pF	50V	CH	GRM39CH101J50PT	K22174235	
D 6001	DIODE				HVU306A5TRF	G2070132	
D 6002	DIODE				HVU306A5TRF	G2070132	
D 6003	DIODE				HVU306A5TRF	G2070132	
D 6004	DIODE				HVU306A5TRF	G2070132	
D 6005	DIODE				1SS153-T2B	G2070032	
J 6001	CONNECTOR				9230B-1-08Z003-T	P0090823	
L 6001	M. RFC	4.7uH			LER015T4R7K	L1690127	
L 6002	COIL				12.0T1.5D0.32UEW R	L0022185	
L 6003	M. RFC	4.7uH			LER015T4R7K	L1690127	
L 6004	COIL				9.0T1.5D0.4UEW R	L0022240	
L 6005	M. RFC	0.056uH			LL2012-F56N	L1690175	
Q 6001	TRANSISTOR				2SC4226-T2B R22	G3342267B	
Q 6002	TRANSISTOR				2SC4226-T2B R22	G3342267B	
Q 6003	TRANSISTOR				2SC4226-T2B R22	G3342267B	
Q 6004	TRANSISTOR				DTC124EE TL	G3070109	
Q 6005	TRANSISTOR				DTC124EE TL	G3070109	
R 6001	CHIP RES.	3.3K	1/16W	5%	RMC1/16 332JATP	J24185332	
R 6002	CHIP RES.	10K	1/16W	5%	RMC1/16 103JATP	J24185103	
R 6003	CHIP RES.	680	1/16W	5%	RMC1/16 681JATP	J24185681	
R 6004	CHIP RES.	0	1/16W	5%	RMC1/16 000JATP	J24185000	
R 6005	CHIP RES.	3.3K	1/16W	5%	RMC1/16 332JATP	J24185332	
R 6006	CHIP RES.	10K	1/16W	5%	RMC1/16 103JATP	J24185103	

# VCO Unit

---

REF.	MFGR'S DESIG	VALUE	WV	TOL.	DESCRIPTION	YAESU P/N	VERS.
R 6007	CHIP RES.	680	1/16W	5%	RMC1/16 681JATP	J24185681	
R 6008	CHIP RES.	10K	1/16W	5%	RMC1/16 103JATP	J24185103	
R 6009	CHIP RES.	100K	1/16W	5%	RMC1/16 104JATP	J24185104	
R 6010	CHIP RES.	39K	1/16W	5%	RMC1/16 393JATP	J24185393	
R 6011	CHIP RES.	68	1/16W	5%	RMC1/16 680JATP	J24185680	
R 6012	CHIP RES.	0	1/16W	5%	RMC1/16 000JATP	J24185000	
	SHIELD CASE (VCO)					R0148520	
	SHIELD REAR (VCO)					R0148530	



# KEYBOARD Unit

## Circuit Diagram

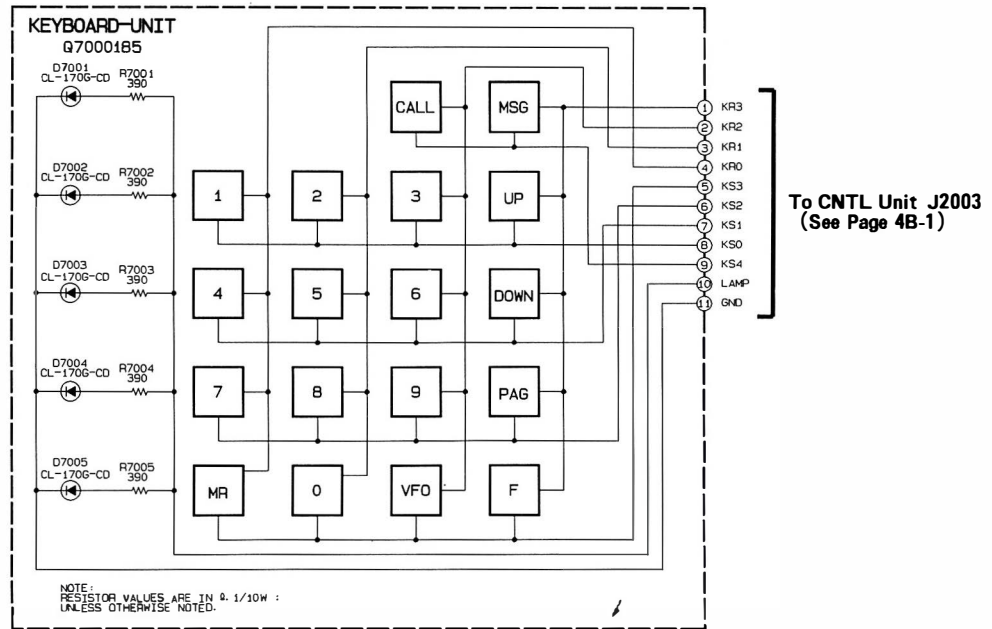

## Parts Layout

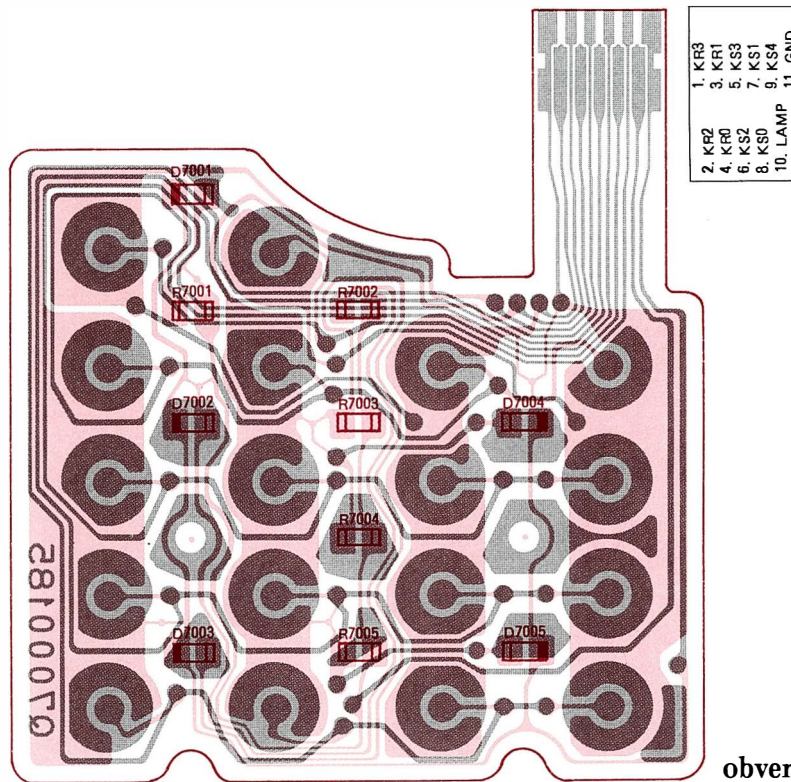

obverse view of chip-only side

## Parts List

REF.	MFGR'S DESIG	VALUE	WV	TOL.	DESCRIPTION	YAESU P/N	VERS.
------	--------------	-------	----	------	-------------	-----------	-------

\*\*\* KEYBOARD UNIT \*\*\*

PCB With Components

Q7000185



# FTS-26 CTCSS Tone Squelch Unit (option)

## Circuit Diagram

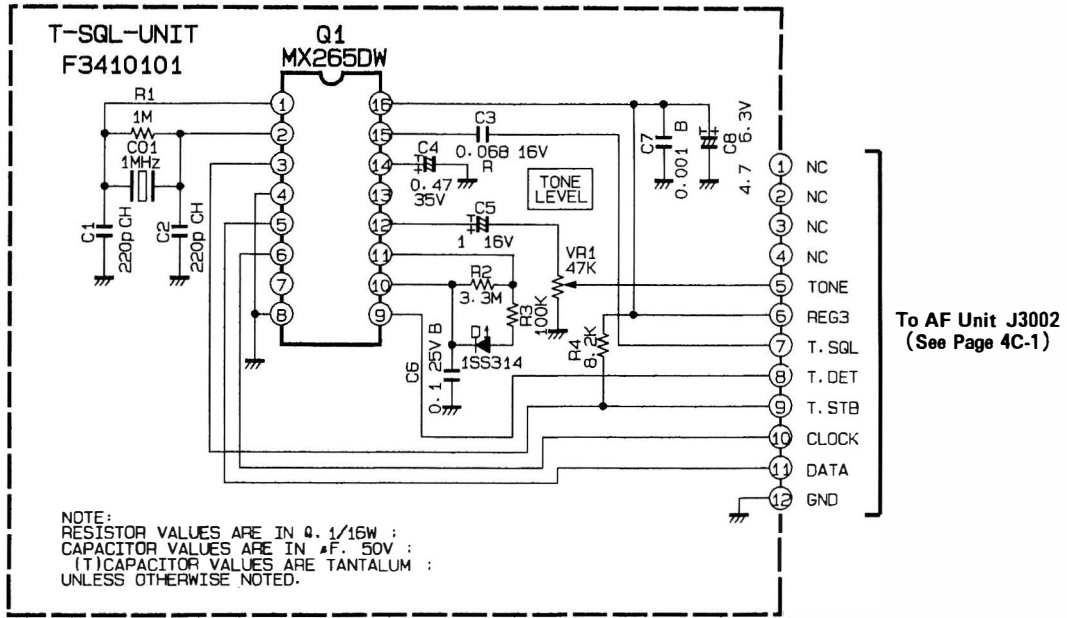

## Parts Layout

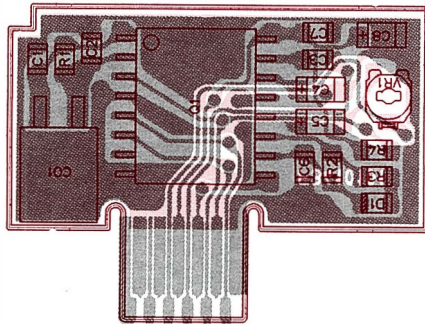

obverse view of component side

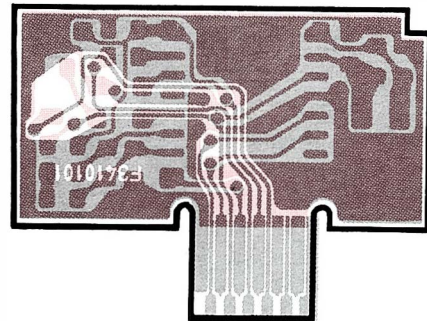

- |     |       |
|-----|-------|
| 1.  | NC    |
| 2.  | NC    |
| 3.  | NC    |
| 4.  | NC    |
| 5.  | TONE  |
| 6.  | REG3  |
| 7.  | T.SGL |
| 8.  | T.DET |
| 9.  | T.STB |
| 10. | CLOCK |
| 11. | DATA  |
| 12. | GND   |

obverse view of solder side

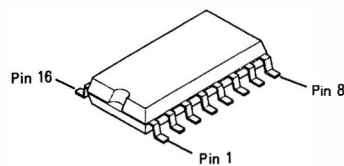

**MX265DW  
(Q0001)**



# FTS-26 CTCSS Tone Squelch Unit (option)

## Parts List

REF.	MFGR'S DESIG	VALUE	WV	TOL.	DESCRIPTION	YAESU P/N	VERS.
*** FTS-26 ***							
Printed Circuit Board						F3410101	
C 0001	CHIP CAP.	220pF	50V	CH	GRM40CH221J50PT	K22170243	
C 0002	CHIP CAP.	220pF	50V	CH	GRM40CH221J50PT	K22170243	
C 0003	CHIP CAP.	0.068uF	16V	R	GRM40R683M16PT	K22120805	
C 0004	TANTALUM CHIP CAP.	0.47uF	35V		TEMSVA1V474M-8R	K78160029	
C 0005	TANTALUM CHIP CAP.	1uF	16V		TESVA1C105M1-8R	K78120009	
C 0006	CHIP CAP.	0.1uF	25V	B	GRM40B104M25PT	K22140811	
C 0007	CHIP CAP.	0.001uF	50V	B	GRM40B102M50PT	K22170805	
C 0008	TANTALUM CHIP CAP.	4.7uF	6.3V		TEMSVA0J475M-8R	K78080017	
CO0001	CERAMIC OSC				CSBF1000J221T-TC01	H7900950	
D 0001	DIODE				1SS314 TPH3	G2070122	
Q 0001	IC				MX265DW-TR	G1091670	
R 0001	CHIP RES.	1M	1/10W	5%	RMC1/10T 105J	J24205105	
R 0002	CHIP RES.	3.3M	1/10W	5%	RMC1/10T 335J	J24205335	
R 0003	CHIP RES.	100K	1/10W	5%	RMC1/10T 104J	J24205104	
R 0004	CHIP RES.	8.2K	1/10W	5%	RMC1/10T 822J	J24205822	
VR0001	POT.	47K			RH03APAS4X	J51793473	



Este manual foi doado por Bernardo Charnis da empresa [wirelesstech.com.br](http://wirelesstech.com.br) para ser scaneado e disponibilizado GRATUITAMENTE a toda a comunidade

Scaneado em cores, 300 DPI (é o maximo que minha maquina faz, nao me batam) em uma copiadora Lexmark X864de, imagens tratadas com o programa IRFANVIEW e pdf gerado com o Adobe Acrobat XI Pro, usando Clearscan

Eu scaneio, trato e disponibilizo manuais gratuitamente meramentepelo prazer de faze-lo. Caso voce queira ajudar com manuais, insumos e ate mesmo uma merrequinha pra ajudar na conta de luze na manutenção da maquina, entre em contato pelo [emailalexandre.tabajara@gmail.com](mailto:emailalexandre.tabajara@gmail.com) (tambem é pix)

Obrigado a todos que ajudaram ate aqui

Os sites onde esses scans podem ser encontrados:

- [www.bama.org](http://www.bama.org)
- <http://tabajara-labs.blogspot.com>
- <http://tabalabs.com.br/esquemateca>
- <https://datassette.org/>

**ATENÇÃO: AS PAGINAS EM BRANCO ESTAO EXATAMENTE COMO NO MANUAL. O OBJETIVO DE MANTE-LAS É VOCE PODER IMPRIMIR UM MANUAL IDENTICO AO ORIGINAL.**

**NAO ESTÁ FALTANDO PAGINA NENHUMA NO MANUAL**

Distribuição GRATUITA. Respeite o meu trabalho.  
São Paulo, 01 de Julho de 2021

Copyright © 1993  
Yaesu Musen Co., Ltd.  
All right reserved.

Downloaded by  
RadioManual.EU

No portion of this manual  
may be reproduced  
without the permission of  
Yaesu Musen Co., Ltd.

Printed in Japan.

E03989000 (312v-0A)