

FT-712RH

TECHNICAL SUPPLEMENT

CONTENTS

1	OUTLINE
2	MAIN UNIT PARTS LAYOUT
3	MAIN UNIT CIRCUIT DIAGRAM
4	MAIN UNIT PARTS LAYOUT (CIRCUIT DIAGRAM)
5	MAIN UNIT PARTS LAYOUT (CIRCUIT DIAGRAM)
6	MAIN UNIT PARTS LAYOUT (CIRCUIT DIAGRAM)
7	MAIN UNIT PARTS LAYOUT (CIRCUIT DIAGRAM)
8	MAIN UNIT PARTS LAYOUT (CIRCUIT DIAGRAM)
9	MAIN UNIT PARTS LAYOUT (CIRCUIT DIAGRAM)
10	MAIN UNIT PARTS LAYOUT (CIRCUIT DIAGRAM)
11	MAIN UNIT PARTS LAYOUT (CIRCUIT DIAGRAM)
12	MAIN UNIT PARTS LAYOUT (CIRCUIT DIAGRAM)
13	MAIN UNIT PARTS LAYOUT (CIRCUIT DIAGRAM)
14	MAIN UNIT PARTS LAYOUT (CIRCUIT DIAGRAM)
15	MAIN UNIT PARTS LAYOUT (CIRCUIT DIAGRAM)
16	MAIN UNIT PARTS LAYOUT (CIRCUIT DIAGRAM)
17	MAIN UNIT PARTS LAYOUT (CIRCUIT DIAGRAM)
18	MAIN UNIT PARTS LAYOUT (CIRCUIT DIAGRAM)
19	MAIN UNIT PARTS LAYOUT (CIRCUIT DIAGRAM)
20	MAIN UNIT PARTS LAYOUT (CIRCUIT DIAGRAM)
21	MAIN UNIT PARTS LAYOUT (CIRCUIT DIAGRAM)
22	MAIN UNIT PARTS LAYOUT (CIRCUIT DIAGRAM)
23	MAIN UNIT PARTS LAYOUT (CIRCUIT DIAGRAM)
24	MAIN UNIT PARTS LAYOUT (CIRCUIT DIAGRAM)
25	MAIN UNIT PARTS LAYOUT (CIRCUIT DIAGRAM)
26	MAIN UNIT PARTS LAYOUT (CIRCUIT DIAGRAM)
27	MAIN UNIT PARTS LAYOUT (CIRCUIT DIAGRAM)
28	MAIN UNIT PARTS LAYOUT (CIRCUIT DIAGRAM)

YAESU MUSEN CO., LTD.
C.P.O. BOX 1500
TOKYO, JAPAN

This manual is intended to serve as a supplement to the FT-712RH Operating Manual. Detailed information regarding functions, specifications, options and operation has been provided in the Operating Manual, and is not reprinted herein. Therefore, this supplement is not intended to serve as an independent reference, but to be used in conjunction with the information provided in the Operating Manual.

Because of the compactness and complexity of the double-sided glass-epoxy circuit boards used in the FT-712RH, four layout diagrams are provided for each board. Each side of the board is identified by the type of the majority of components installed on that side. In most cases one side has only chip components, and the other has either a mixture of both chip and lead components (trimmers, coils, electrolytic capacitors, packaged ICs, etc.), or lead components only. The two "obverse" views depict the board as it is seen when viewed directly with the eye, while the two "reverse" views depict the unseen side of the board as it would appear if one were to peer through the board from the other side without seeing the components and tracks on the near side.

While we believe the technical information in this manual is correct, Yaesu assumes no liability for damage that may occur as a result of typographical or other errors that may be present. Your cooperation in pointing out any inconsistencies in the technical information would be appreciated.

Yaesu Musen reserves the right to make changes in the circuitry of this transceiver, in the interest of technological improvement, without notification of the owners.

CONTENTS

CIRCUIT BOARD ACCESS	1
MAIN UNIT PARTS LAYOUT	3
MAIN UNIT CIRCUIT DIAGRAM	8
IF UNIT PARTS LAYOUT/CIRCUIT DIAGRAM	9
MIC UNIT PARTS LAYOUT/CIRCUIT DIAGRAM	10
APC UNIT PARTS LAYOUT/CIRCUIT DIAGRAM	11
430-VCO UNIT PARTS LAYOUT/CIRCUIT DIAGRAM	12
CONTROL UNIT PARTS LAYOUT	13
CONTROL UNIT CIRCUIT DIAGRAM	16
PA UNIT PARTS LAYOUT	17
PA UNIT CIRCUIT DIAGRAM	19
SEMICONDUCTOR CROSS-REFERENCE	20
BLOCK DIAGRAM	21
EXPLODED VIEW	22
ALIGNMENT	23
ALIGNMENT (PLL)	24
ALIGNMENT (Transmitter)	25
ALIGNMENT (Receiver)	27
PARTS LIST	28

CIRCUIT BOARD ACCESS

BOTTOM COVER REMOVAL

The following circuit boards are accessed by removing the bottom cover:

- Main Unit* (component side)
- IF Unit*
- Mic Unit*
- APC Unit
- VCO Unit
- PA Unit (lower edge only)

To remove the bottom cover, remove the four screws marked "★" in Figure 1, plus the four marked "※" if the top cover has not already been removed. Then lift the cover away.

* To access these boards it may be necessary to remove the loudspeaker and holder:

- (1) Referring to Figure 2, unplug the speaker wire connector from J1005 on the Main Unit, and lift the loudspeaker out of its bracket.
- (2) Remove the three screws in the arms of the speaker bracket and remove the bracket.

TOP COVER REMOVAL

Removing the top cover exposes the Solder Side of the Main Unit circuit board and the top edge of the PA Unit board.

To remove the top cover, remove the four screws marked "○" in Figure 1, plus the four marked "※" if the bottom cover has not already been removed. Then lift the cover away.

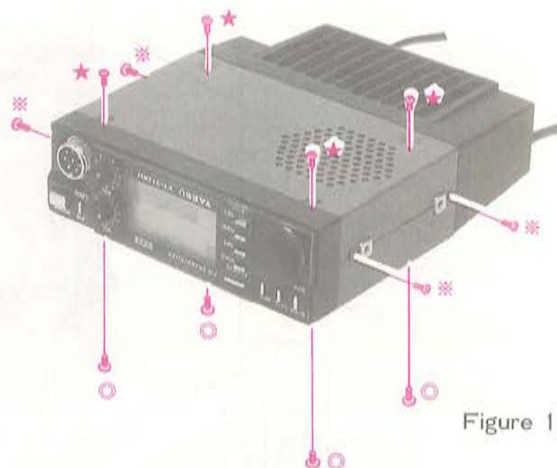

Figure 1

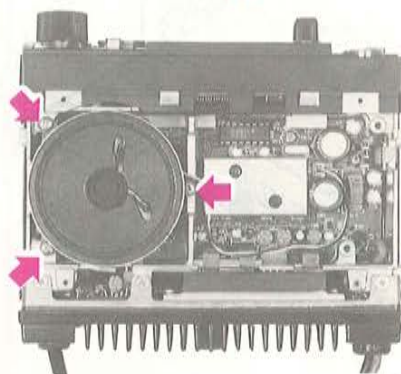

Figure 2

FRONT PANEL REMOVAL

Removing the front panel allows access to the Control Unit and LCD Unit circuit boards.

- (1) After the top and bottom covers have been removed, pull off the Selector, VOL and SQL knobs.
- (2) Remove the nut from the microphone jack using a slotted ring wrench as shown in Figure 3.

The front panel can now be slid forward.

CIRCUIT BOARD ACCESS

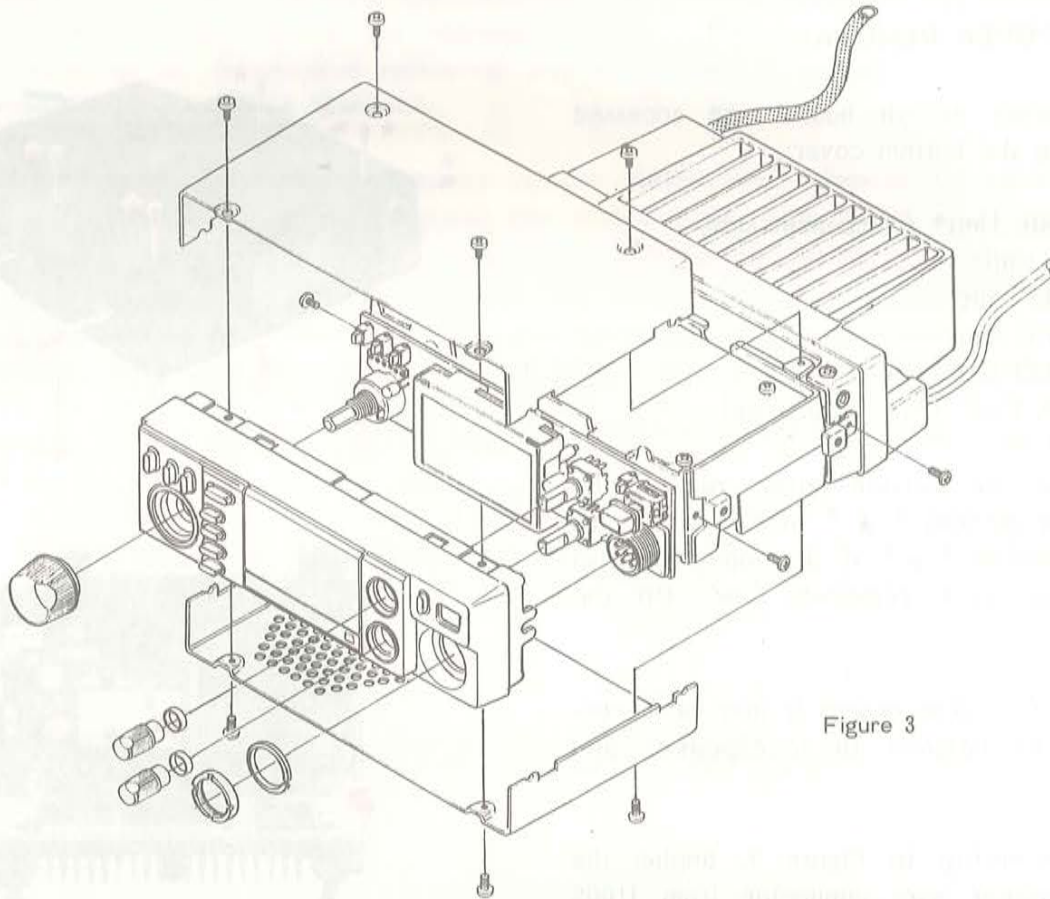
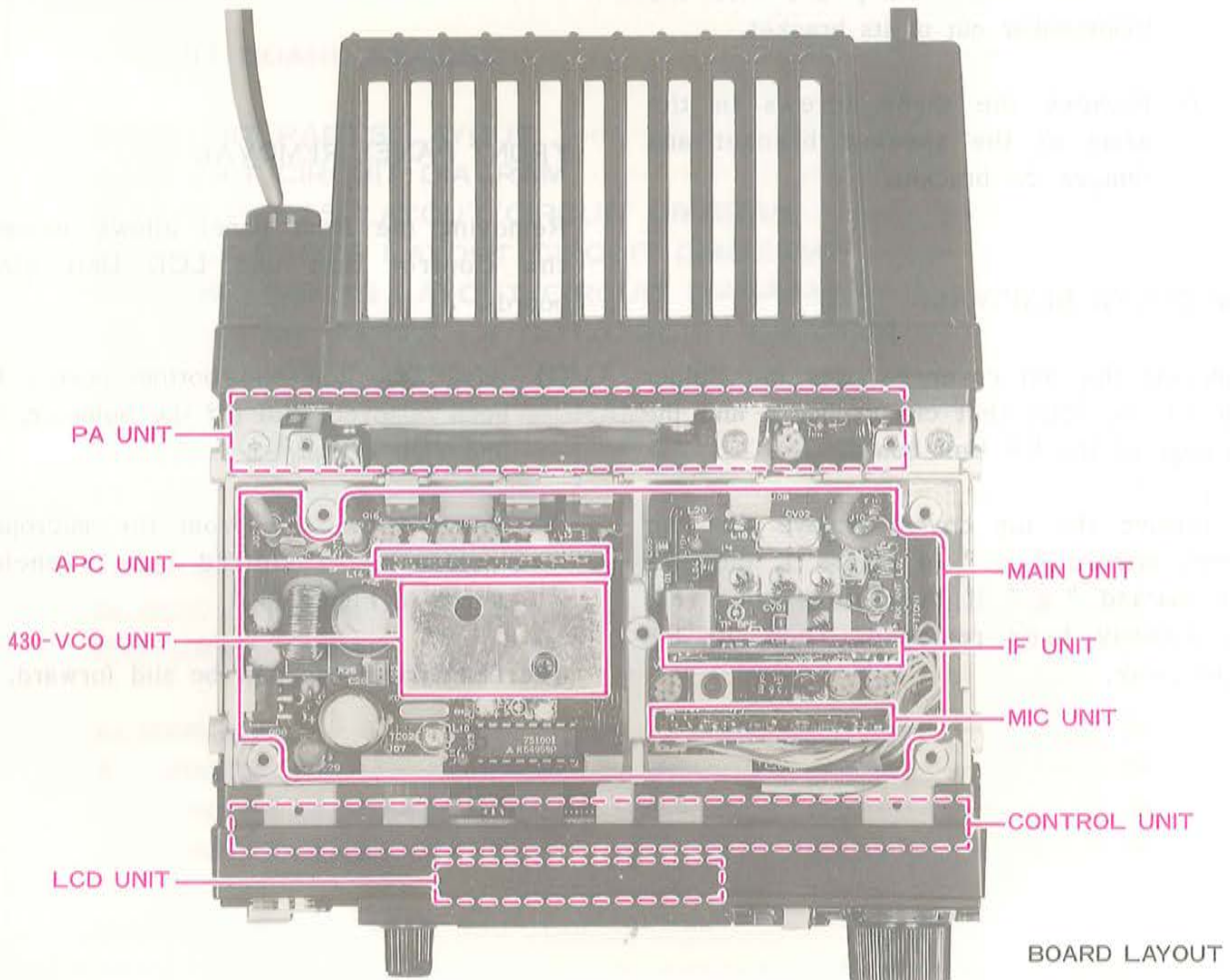

Figure 3



BOARD LAYOUT

MAIN UNIT PARTS LAYOUT

MAIN UNIT (No. 1 XXX)

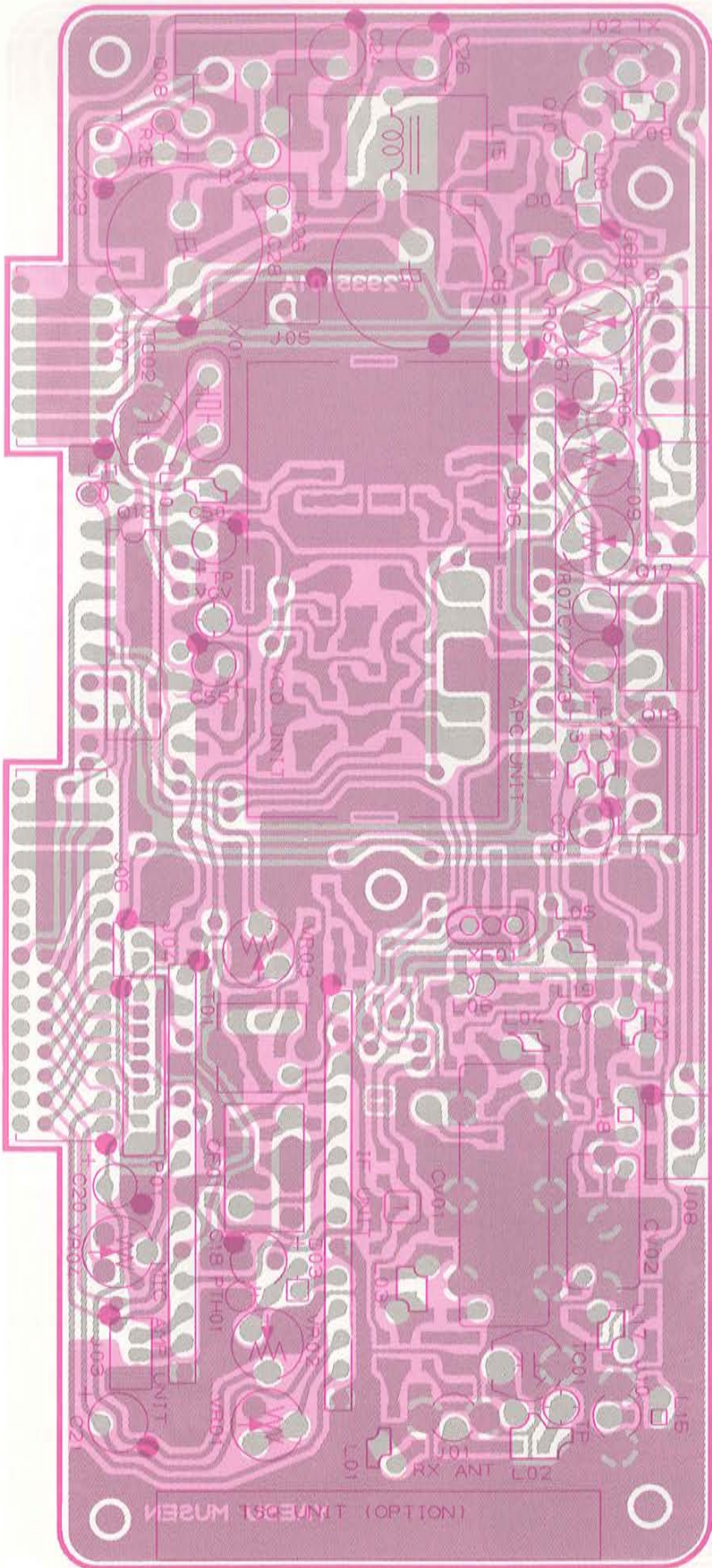

obverse view of "component" side

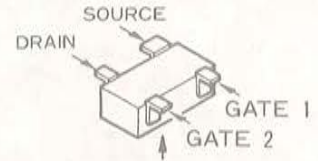

Marked surface

3SK164(F) (Q1001)

3SK165(J) (Q1002)

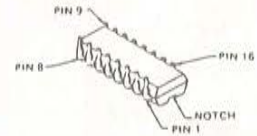

M54959P(Q1013)

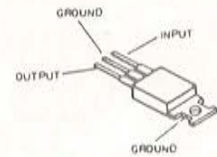

µPC7805H (Q1018)

L7809 (Q1017)

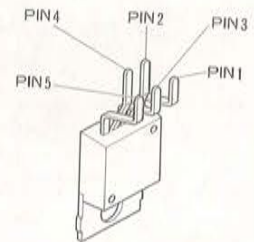

TDA2003 (Q1008)

MAIN UNIT PARTS LAYOUT

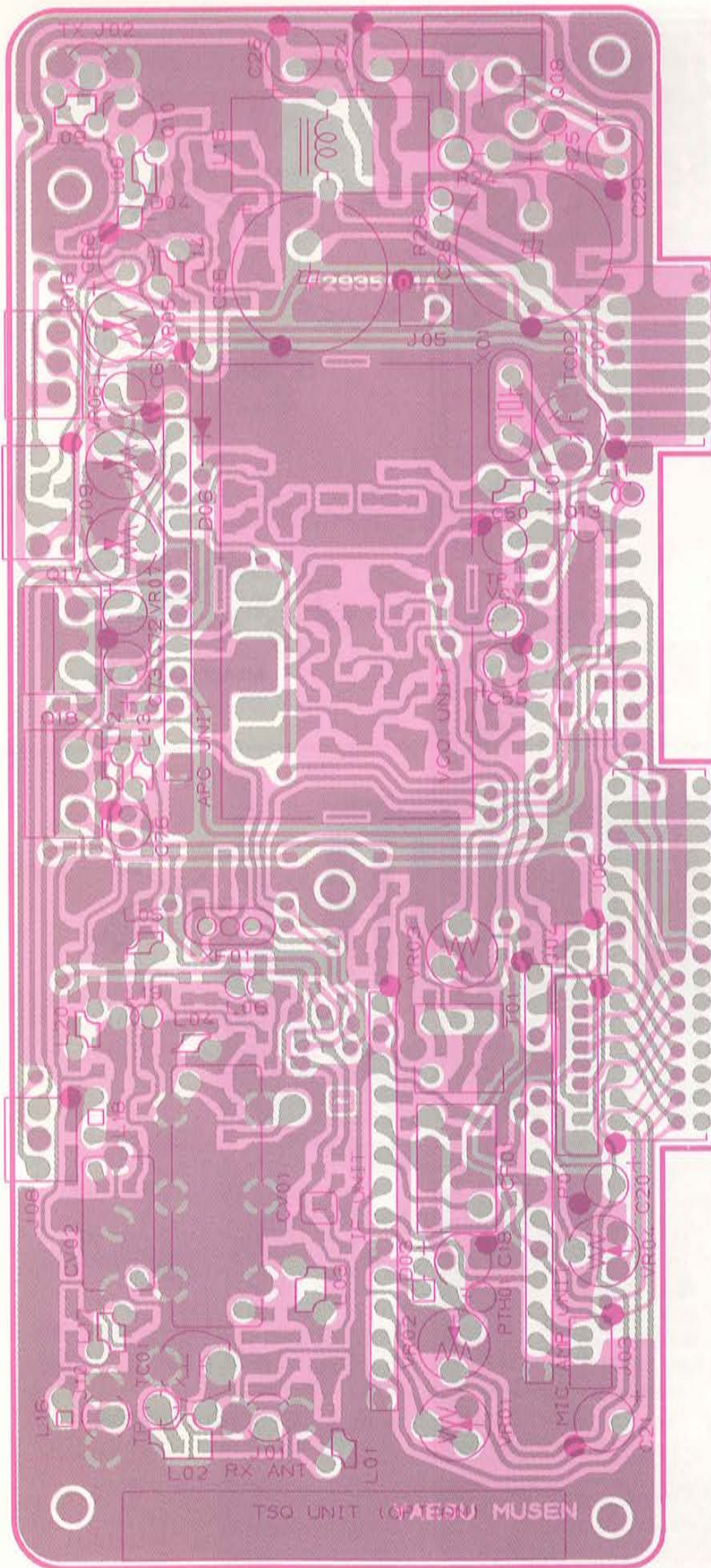

reverse view of "component" side

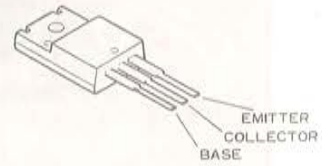

2SB1134R (Q1016)

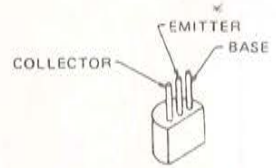

2SC2407(A) (Q1010)



2SD1000(LL) (Q1007)
2SC3357(RK) (Q1009)

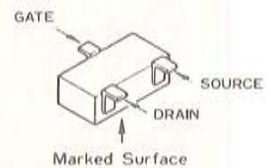

2SK208Y (JY) (Q1014)

MAIN UNIT PARTS LAYOUT

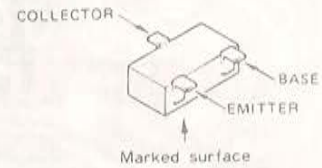
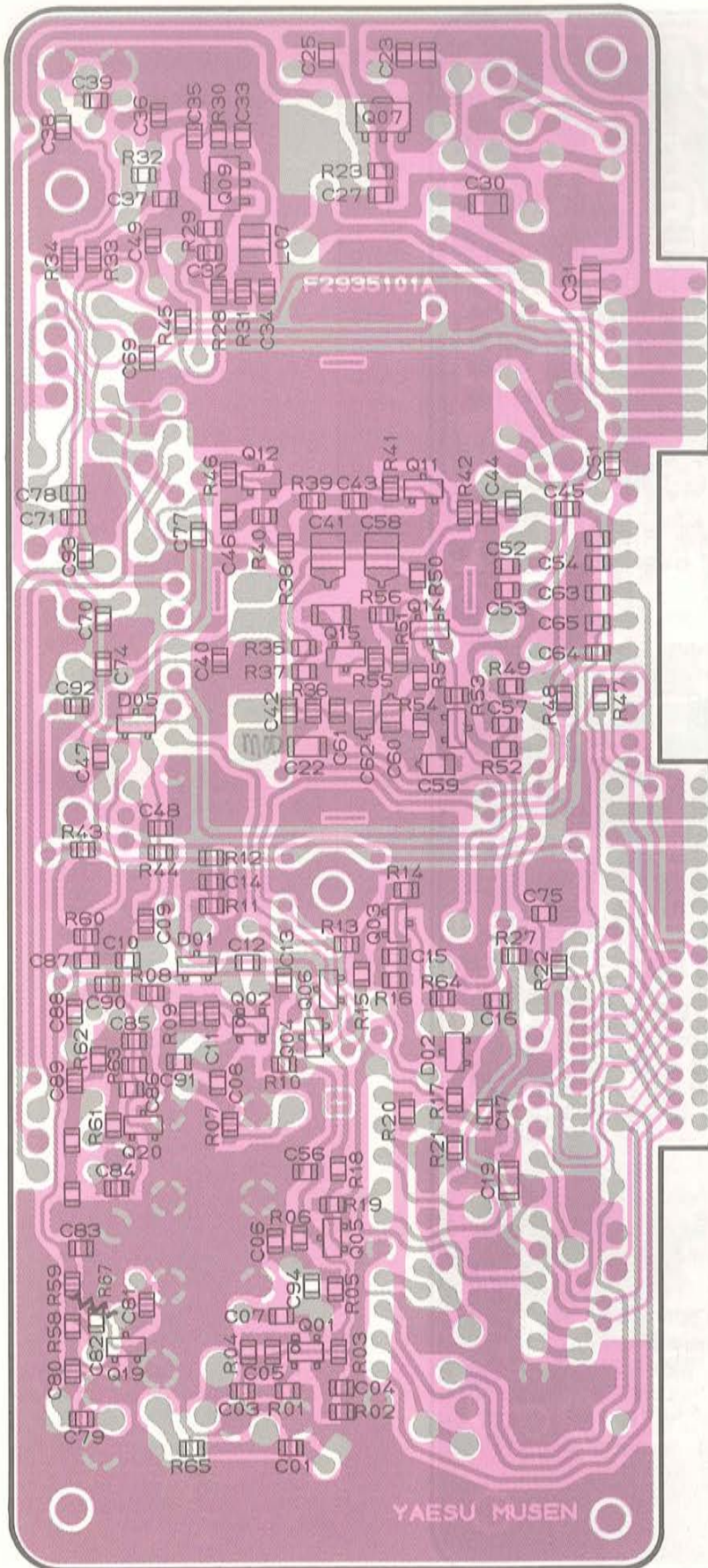

- 2SA812(M7) (Q1005)
- 2SC1623(L7)
- (Q1004,1006,1015)
- 2SC2620(QB) (Q1003)
- 2SC3356(R24)
- (Q1011,1012)

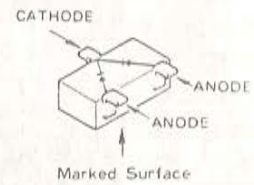

- 1SS184(B3) (D1001)
- HSM2693(B2) (D1005)

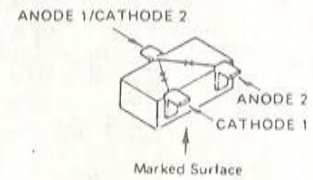

- 1SS226(C3) (D1002)

obverse view of "chip-only" side

MAIN UNIT PARTS LAYOUT

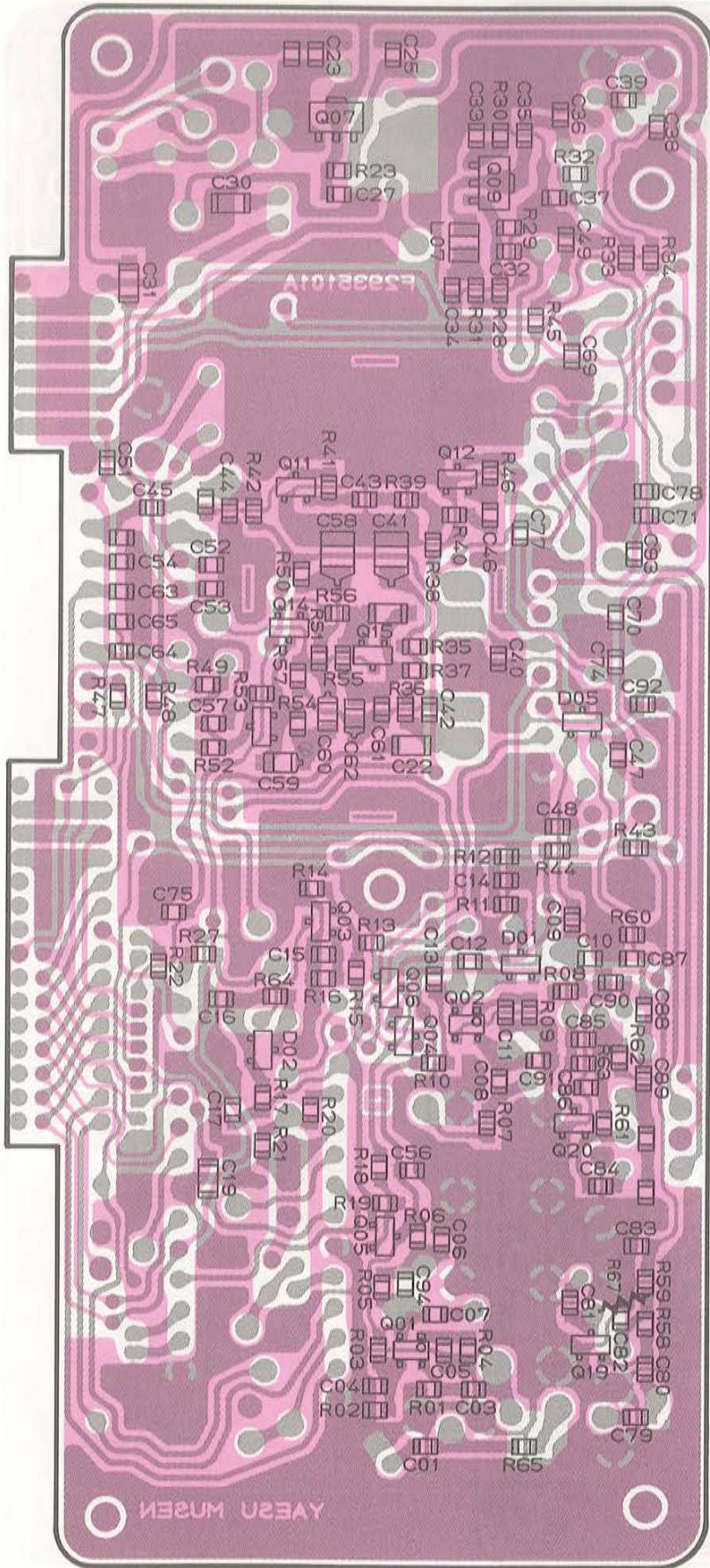

reverse view of "chip-only" side

MAIN UNIT PARTS LAYOUT

MAIN UNIT VOLTAGE CHART

(DC VOLTS)

Symbol No.	E(S)	C(D)	B(G ₁)	G ₂	REMARKS
Q1001	8.8/0	0.7/0	2.1/-0.5	0.4/-0.9	RX/TX
Q1002	8.0/0	1.4/0	0	0	RX/TX
Q1003	1.3/0	8.7/0.4	2.0/0.8		RX/TX
Q1004	0.1	8.7	0		
Q1005	9.0/0.4	8.9/0	8.2/0.2		RX/TX
Q1006	0	0.7	0		
Q1007	12.8	13.5	13.5		
Q1009	0/0.6	0/8.6	0		RX/TX
Q1010	0	-0.3/-0.9	-0.4/-0.2		RX/TX
Q1011	0	4.9	0.7		
Q1012	0	0.7	4.2/5.4		RX/TX
Q1014	2.4/2.3	8.0/8.4	2.7/2.5		RX/TX
Q1015	0.6/0.5	1.8/6.0	0		RX/TX
Q1016	13.5	0	13.5		
Q1019	0	6.5	0.4		
Q1020	0	4.3	0.8		

MAIN UNIT IC VOLTAGE CHART

(DC VOLTS)

Symbol No.	Pin No.	1	2	3	4	5	6	7	8	9	10	11	12	13	14	15	16	REMARKS
Q1008		1.4	0.8	0	5.9	12.8												
Q1013		2.80	2.80	4.80	0.05	0.06	0.10/4.00	0.60	0	2.70	0	4.80	0	0	2.60	2.00	4.80	RX/TX
Q1017		13.5	0	9.0														
Q1018		9.0	0	5.0														

MAIN UNIT CIRCUIT DIAGRAM

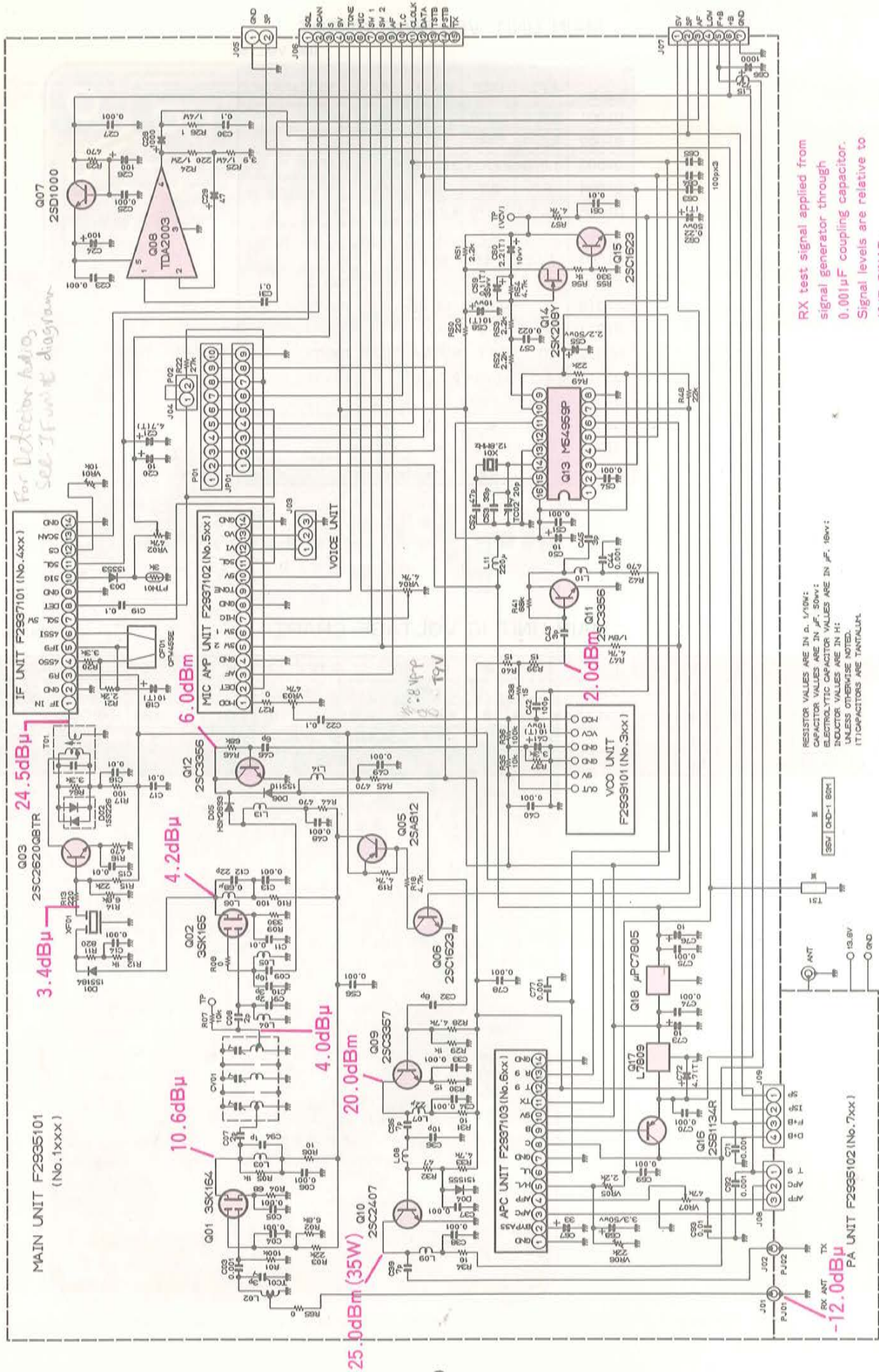

RX test signal applied from signal generator through 0.001μF coupling capacitor. Signal levels are relative to 12dB SINAD.

RESISTOR VALUES ARE IN Ω, K/Ω/M/Ω/K.
CAPACITOR VALUES ARE IN pF, 50nV.
ELECTROLYTIC CAPACITOR VALUES ARE IN μF, 10μV.
INDUCTOR VALUES ARE IN H.
UNLESS OTHERWISE NOTED, ITT CAPACITORS ARE TANTALUM.

□ SMD (D-D-1) SMT

○ ANT

○ 15.8V

○ GND

IF UNIT PARTS LAYOUT/CIRCUIT DIAGRAM

IF UNIT (No. 4 XX)

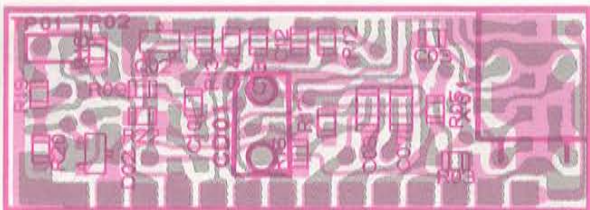

obverse view of "mixed-component" side

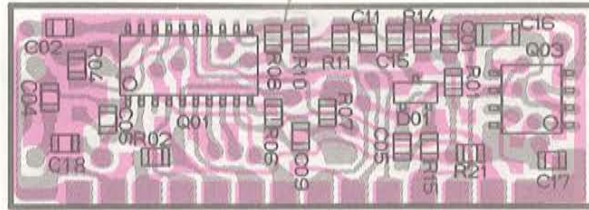

obverse view of "chip-only" side

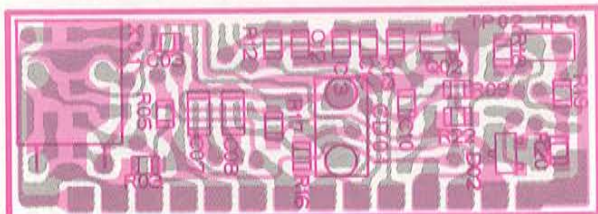

reverse view of "mixed-component" side

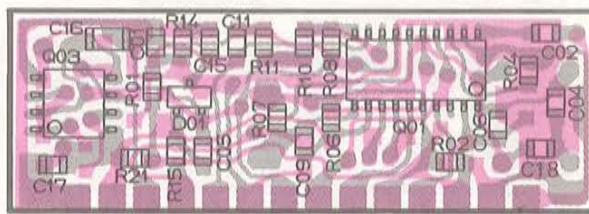

reverse view of "chip-only" side



M5223FP (Q403)

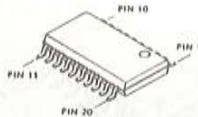

TK10487M (Q401)

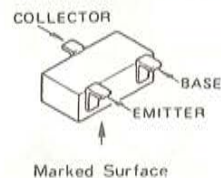

2SC1623(L6) (Q402)

IF UNIT VOLTAGE CHART

(DC VOLTS)

1	2	3	4	5	6	7	8	9	10	11	12	13	14	REMARKS
FM IN	GND	RX 9V	455 OUT	IF 9	455 IN	SOL SW	DET	GND	SIG	SOL	CS	SCAN	GND	
8.7/0	0	9.0/0	8.0/0	8.4/0	6.6/0	50 OFF 50 ON WD 740	3.2/0	0		02-16/10	2.7/0	50 DT 50 ON 1804 504	0	RX/TX

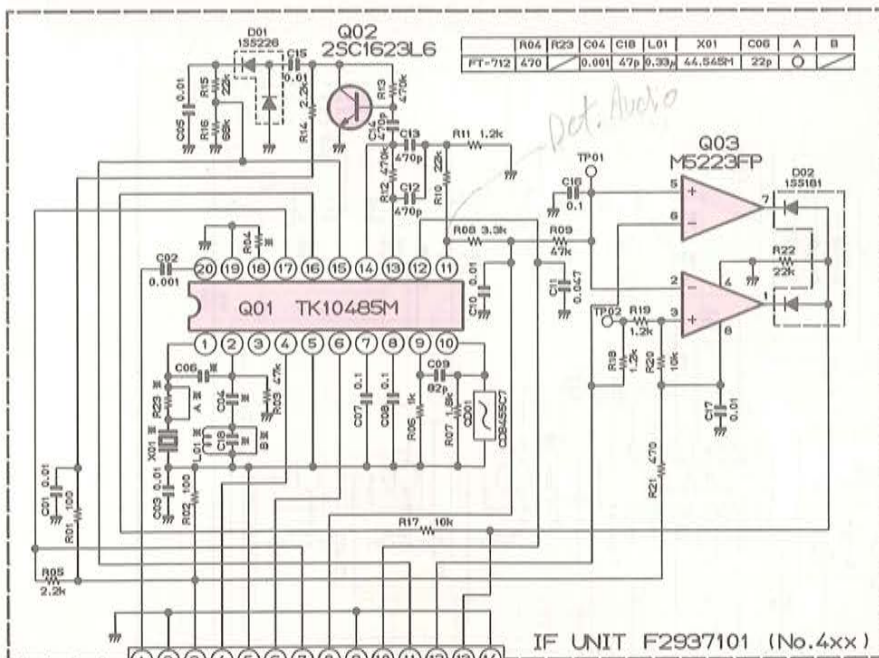

IF UNIT F2937101 (No. 4xx)

RESISTOR VALUES ARE IN Ω , 1/10W!
CAPACITOR VALUES ARE IN μ F, 50vV!
INDUCTOR VALUES ARE IN H!
UNLESS OTHERWISE NOTED.

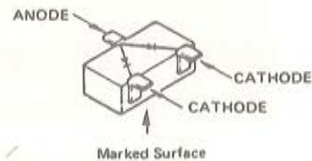

1SS181(A3) (D402)

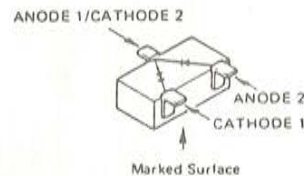

1SS226(C3) (D401)

MIC UNIT PARTS LAYOUT/CIRCUIT DIAGRAM

MIC UNIT (No. 5 × ×)

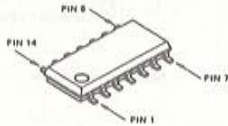
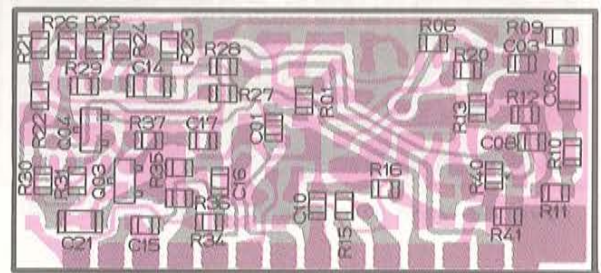
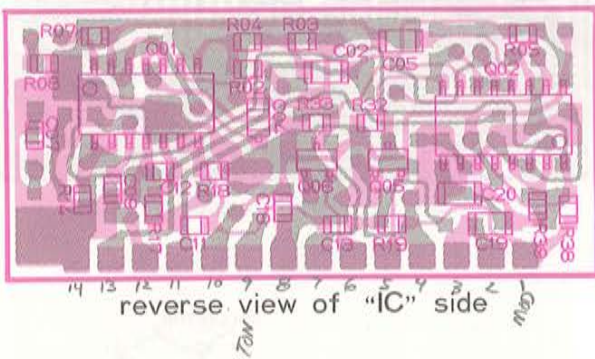
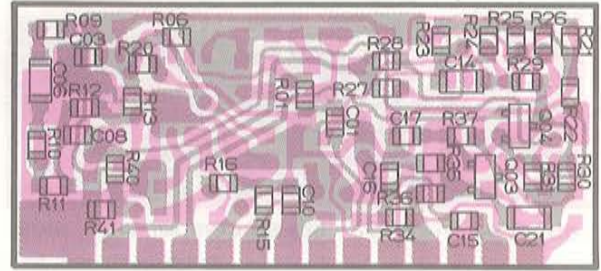
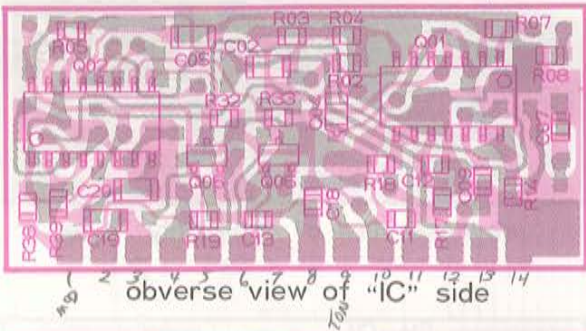

LA6324M (Q501)

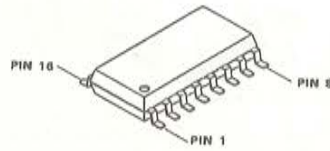

μPD4052BG (Q502)

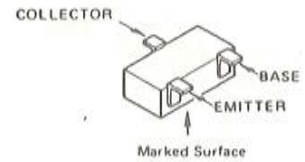

2SC1623(L6) (Q503)
FA1A4M-T2B (L33)
(Q504-506)

MIC UNIT VOLTAGE CHART

(DC VOLTS)

1/ MOD	2/ DET	3/ AF	4/ GND	5/ SW2	6/ SW1	7/ MIC	8/ GND	9/ TONE	10/ 9V	11/ SQL	12/ VI	13/ VO	14/ GND	REMARKS
0/2.0			0	0/4.8	0	0	0	1.7/1.7	9.0/9.0	50 OFF 50 ON 0/0 12/0	3.0/3.0	3.0/3.0	0	RX/TX

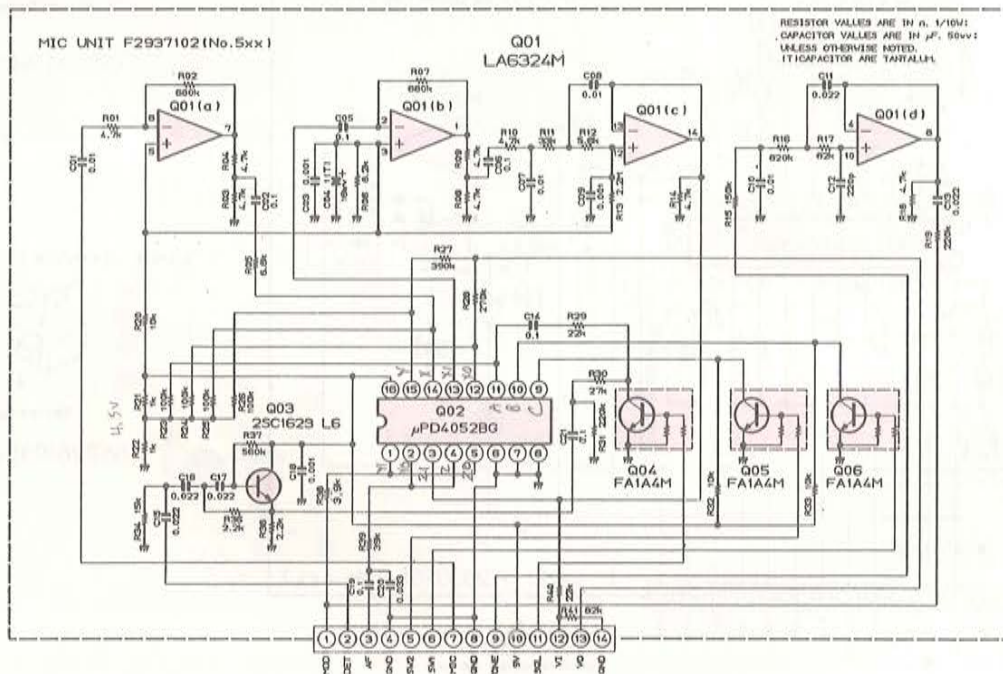

APC UNIT PARTS LAYOUT/CIRCUIT DIAGRAM

APC UNIT (No. 6XX)

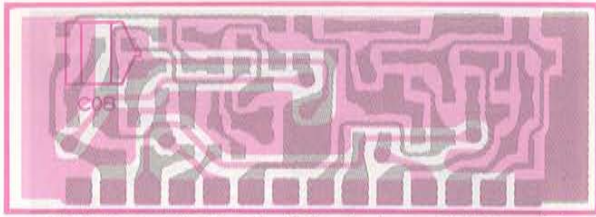

obverse view of "Tantalum CAP" side

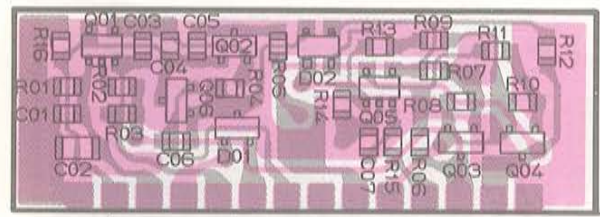

obverse view of "chip-only" side

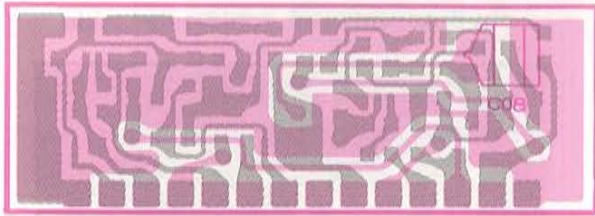

reverse view of "Tantalum CAP" side

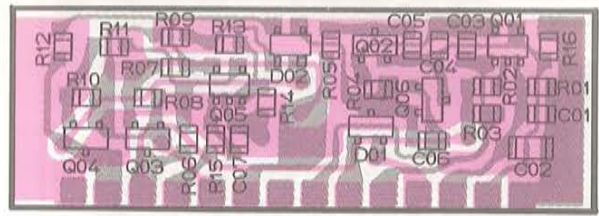

reverse view of "chip-only" side

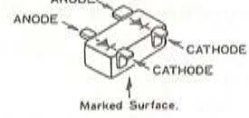
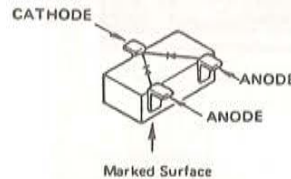
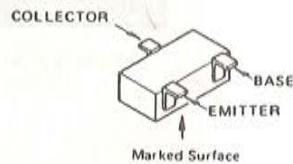
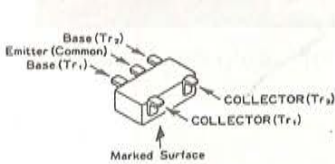

FMS1(S1) (Q601)

FMW1(W1) (Q605)

2SB624(BV4) (Q603,604)

2SC1623(L6) (Q602)

FA1A4M-T2B(L33) (Q606)

1SS184(B3) (D601)

1SS272(A1) (D602)

APC UNIT VOLTAGE CHART

(DC VOLTS)

1	2	3	4	5	6	7	8	9	10	11	12	13	14	REMARKS
GND	BYPSS	APC	AFP	H/L	UL	GND	C	B	9V	TX	T9	R9	GND	RX/TX
0	0/0,6	0/5,7	0	RF HIGH RF LOW 0/5,1 0/1,2	0,1/0,1	0	0/0,8	13,5/13,0	9,0/9,0	0/4,0	0/9,0	9,0/0	0	

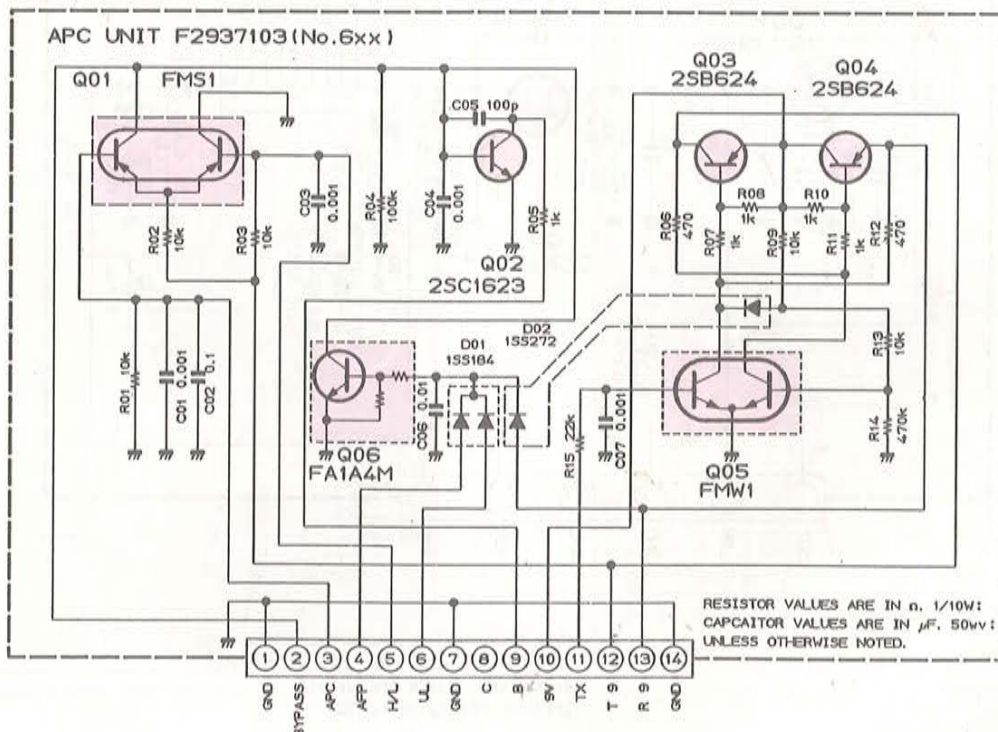

430-VCO UNIT PARTS LAYOUT/CIRCUIT DIAGRAM

430-VCO UNIT (No. 3 × X)

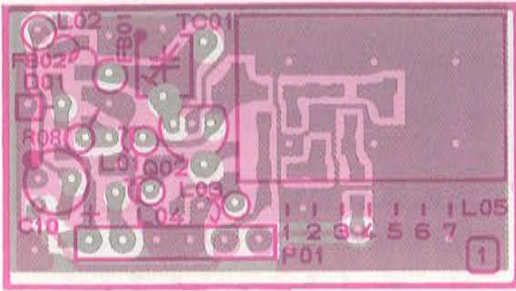

obverse view of "component" side

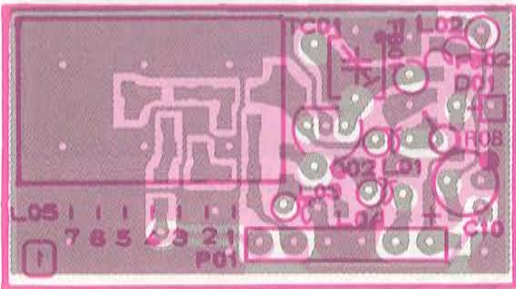

reverse view of "component" side

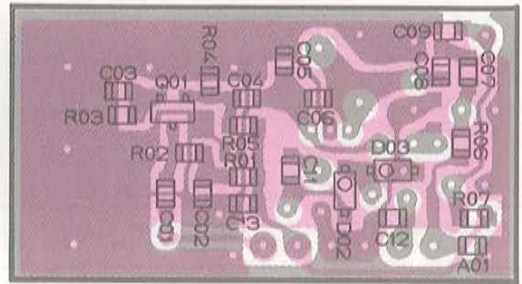

obverse view of "chip-only" side

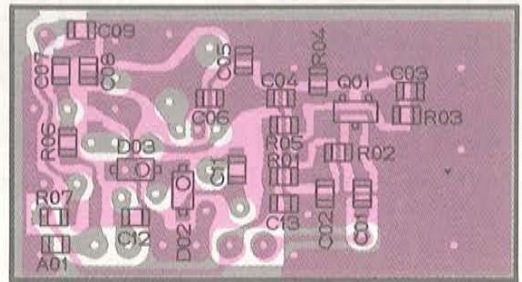

reverse view of "chip-only" side

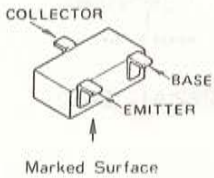

2SC3356(R24) (Q301)

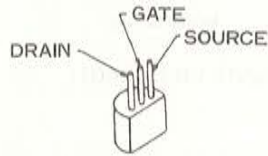

2SK125 (Q302)

VCO UNIT VOLTAGE CHART
(DC VOLTS)

OUT	9V	GND	GND	VCV	MOD
0	9.0	0	0		2.2

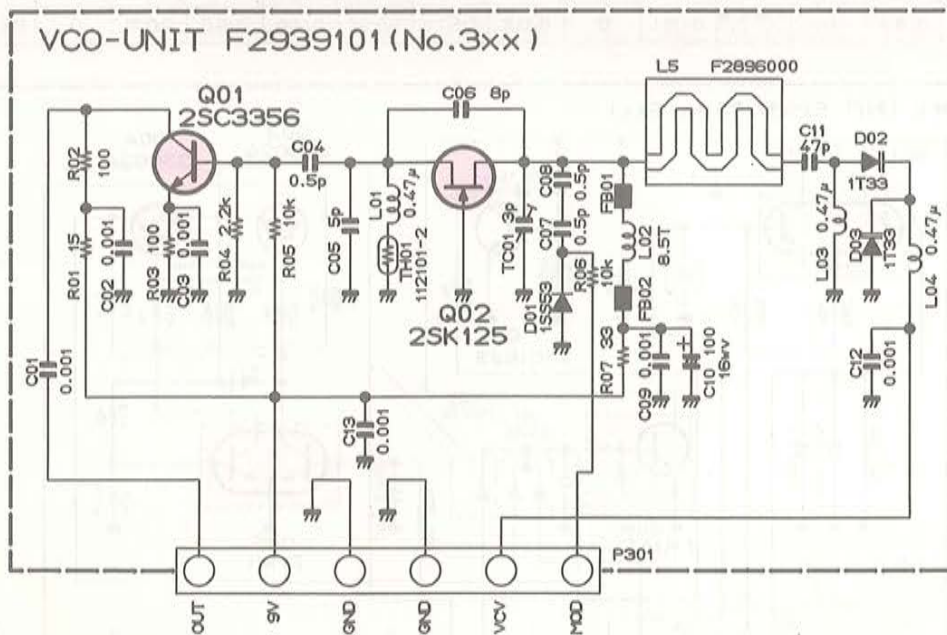

RESISTOR VALUES ARE IN Ω , 1/10W;
CAPACITOR VALUES ARE IN μ F, 50wv;
INDUCTOR VALUES ARE IN H;
UNLESS OTHERWISE NOTED.

CONTROL UNIT PARTS LAYOUT

CONTROL UNIT (No. 2XXX)

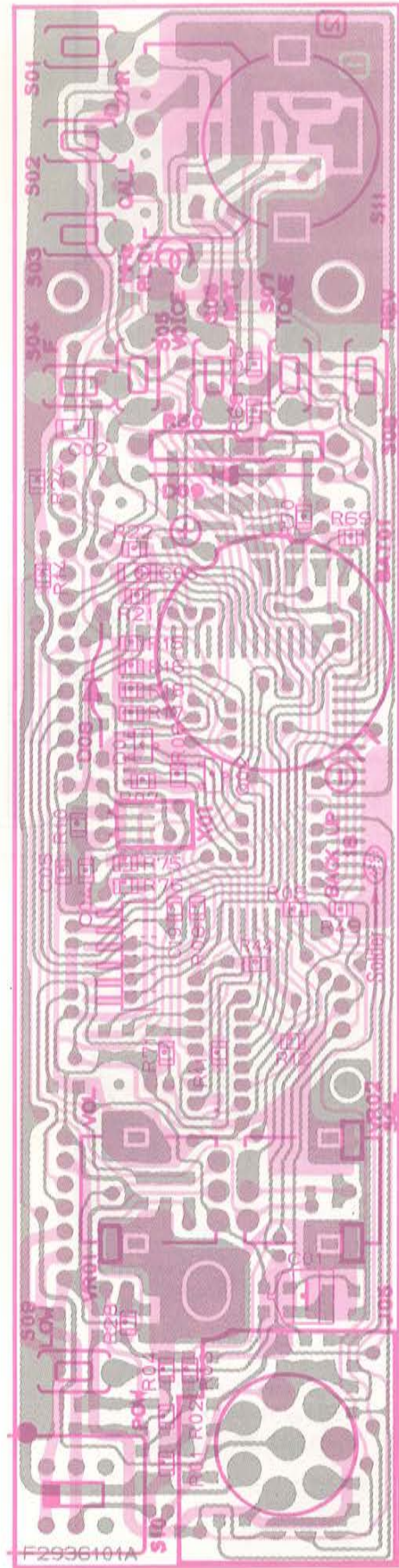
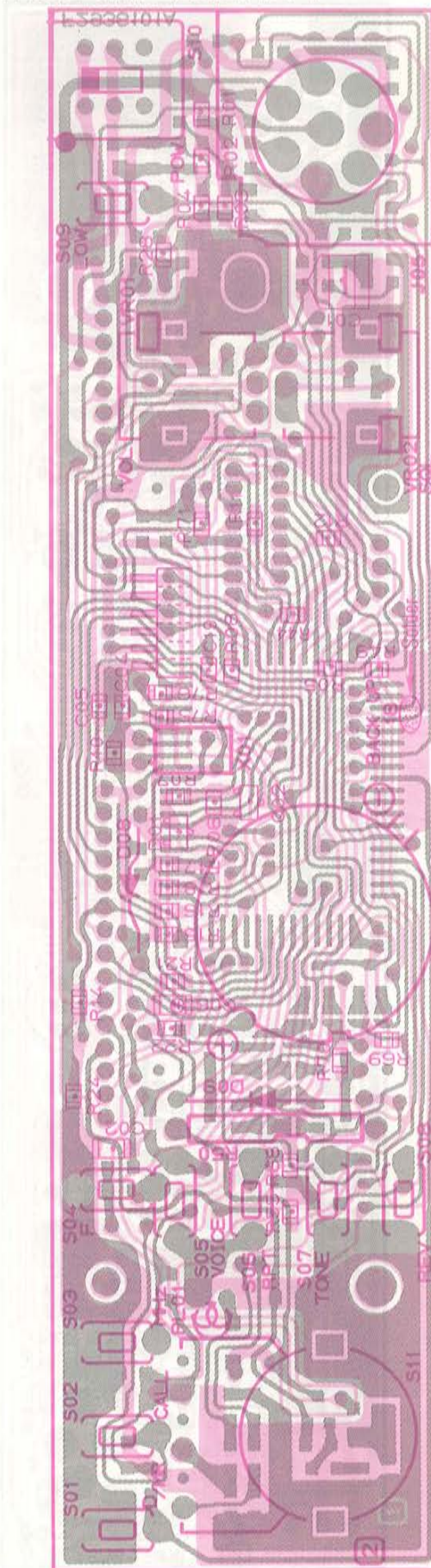

obverse view of "mixed-component" side reverse view of "mixed-component" side

CONTROL UNIT PARTS LAYOUT

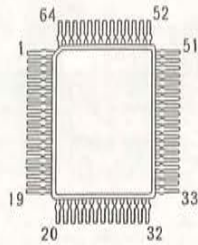

HD404418A01F (Q2003)

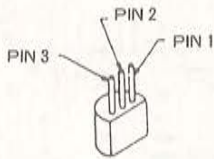
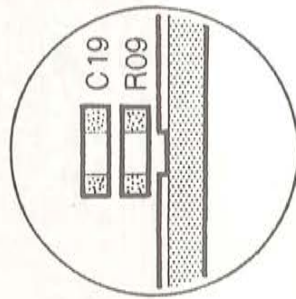

PST523C-2 (Q2001)

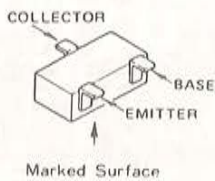

- 2SA812(M6) (Q2002)
- 2SB624(BV4) (Q2005)
- 2SC1623(L6) (Q2004,2006)

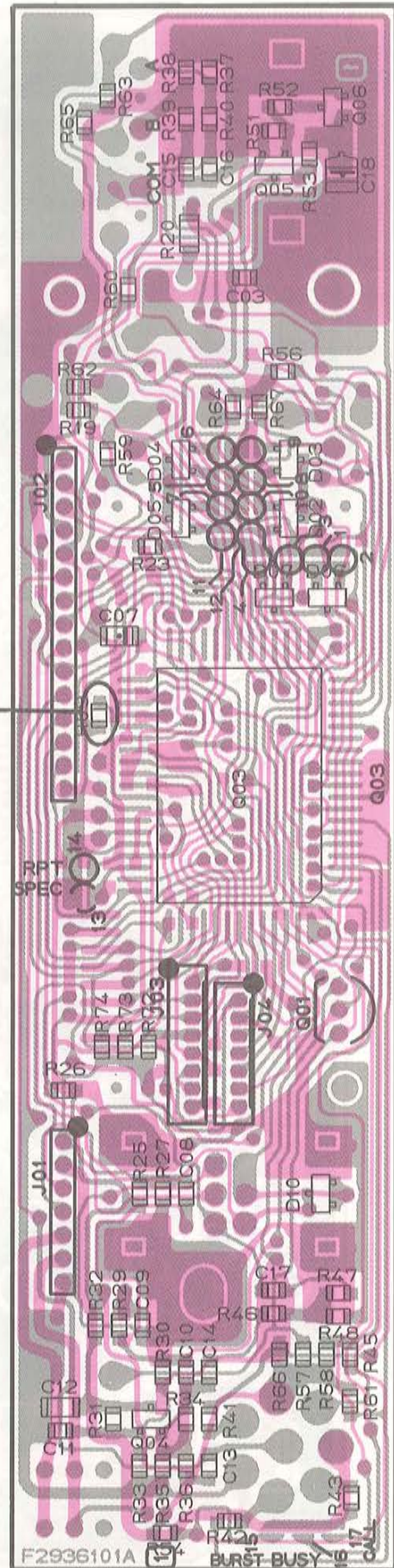

obverse view of "IC" side

CONTROL UNIT PARTS LAYOUT

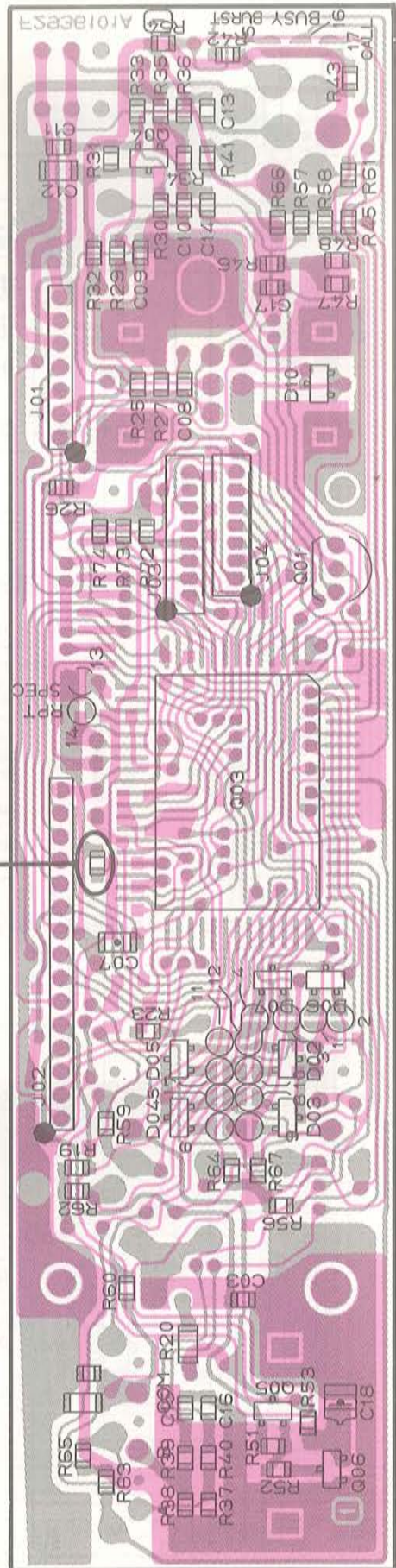

obverse view of "IC" side

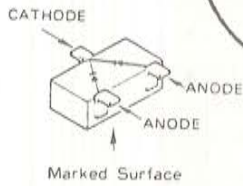

1SS184(B3)
 (D2002,2003,2004)
 2005,2006,2007
 2010

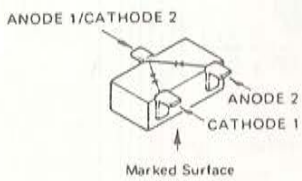

1SS226(C3) (D2001)

CONTROL UNIT CIRCUIT DIAGRAM

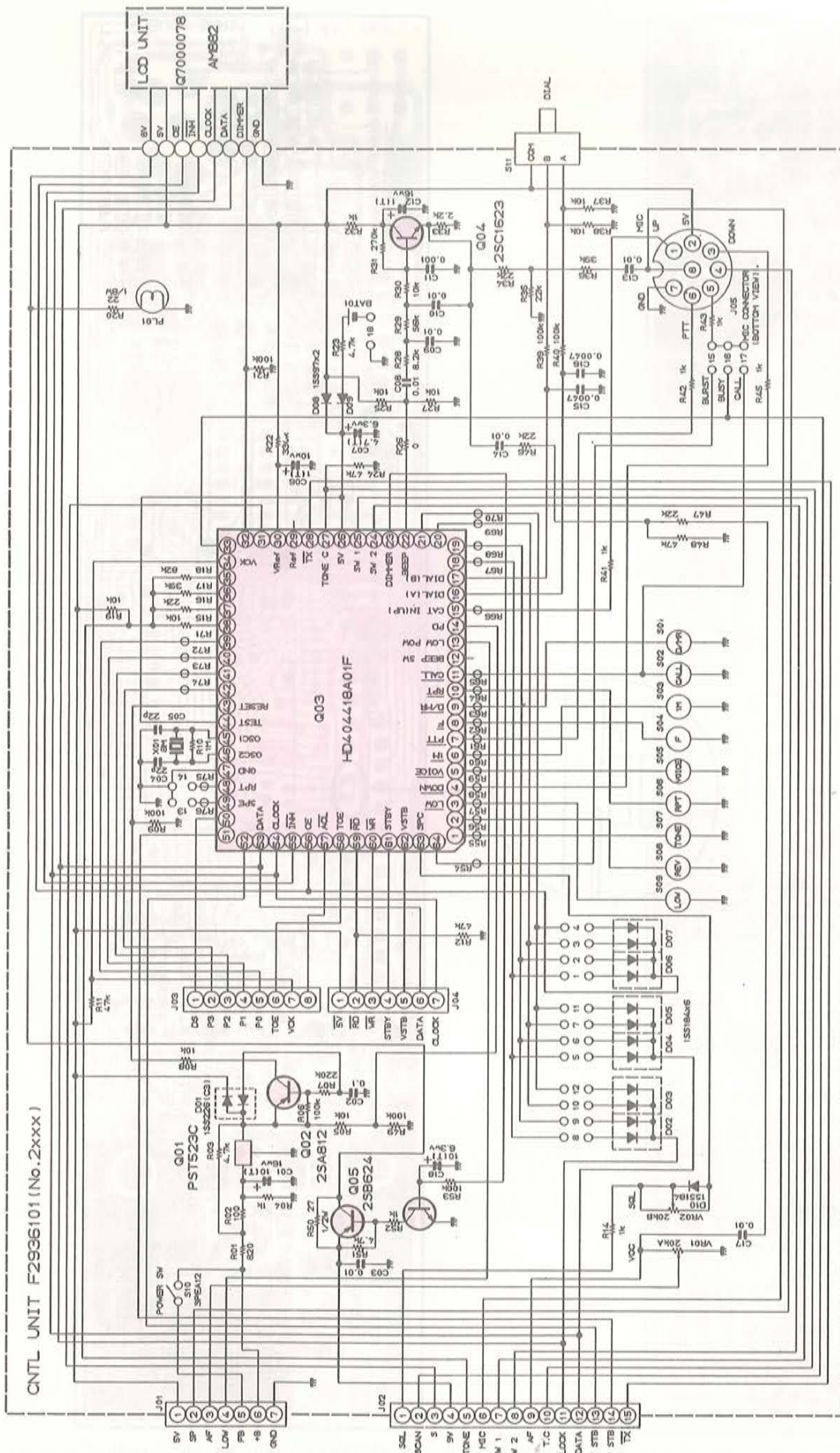

- RESISTOR VALUES ARE IN Ω , 1/10W;
 CAPACITOR VALUES ARE IN μ F, 50V;
 UNLESS OTHERWISE NOTED.
 (†)COMPONENTS ARE TANTALUM.
- 1 B550
 - 2 B31
 - 3 B52
 - 4 B53
 - 5 1F70
 - 6 1F71
 - 7 3P72
 - 8 5350
 - 9 5351
 - 10 PR5
 - 11 STE
 - 12 P5
 - 13 SPECIAL
 - 14 RPT
 - 15 BURST
 - 16 BURST
 - 17 CALL
 - 18 BACK UP
- R54, R56, R51, R55, R56: 22 Ω
 - R55-R57: 15 Ω
 - R58, R59: 15 Ω
 - R62-R64: 15 Ω
 - R57-R76: 15 Ω
 - R44: OUT OF USE

PA UNIT PARTS LAYOUT

PA UNIT (No. 7XX)

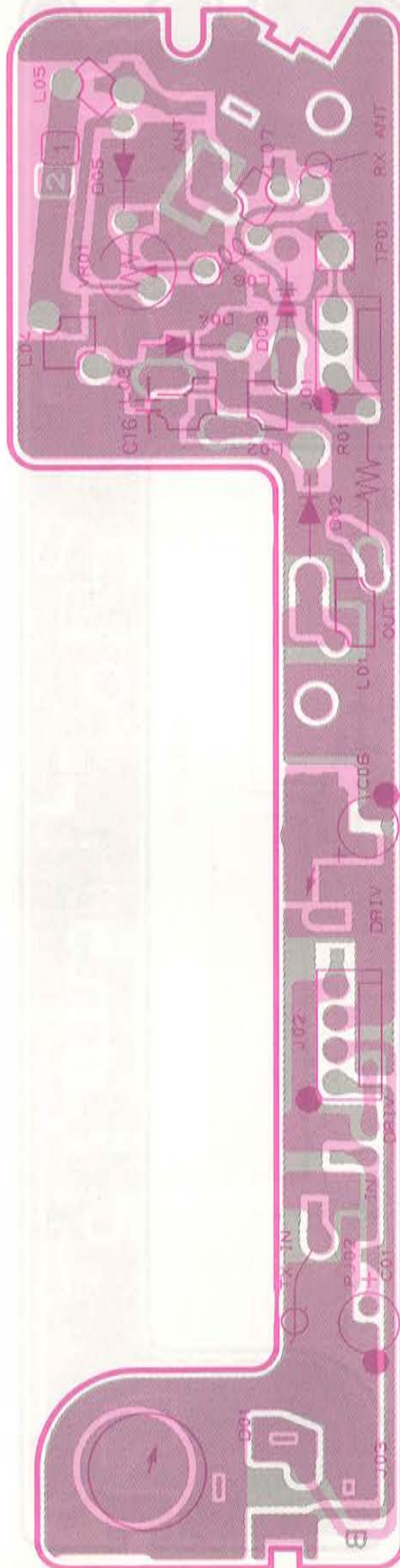

obverse view of "component" side

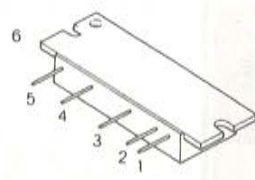

1. INPUT
2. Vcc₁
3. Vcc₂
4. Vcc₃
5. OUTPUT
6. FLA

M57788M(Q701)

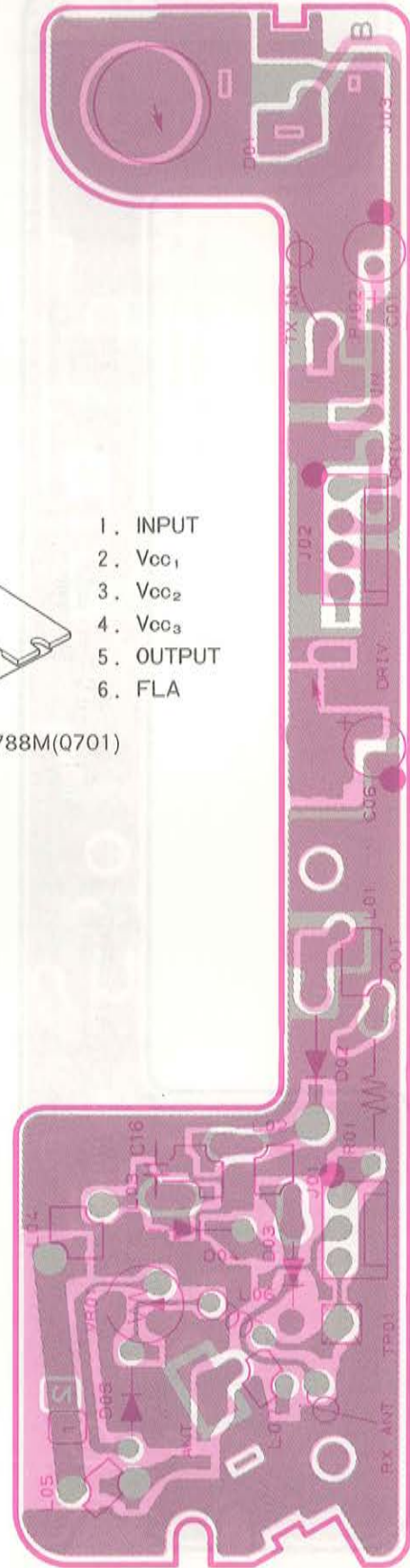

reverse view of "component" side

PA UNIT PARTS LAYOUT

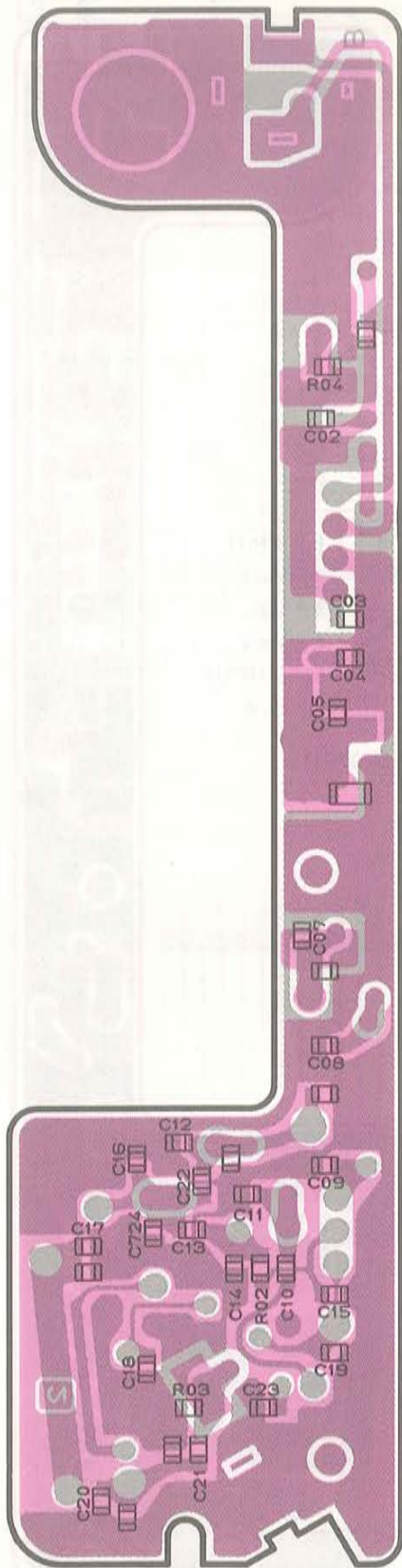

obverse view of "chip-only" side

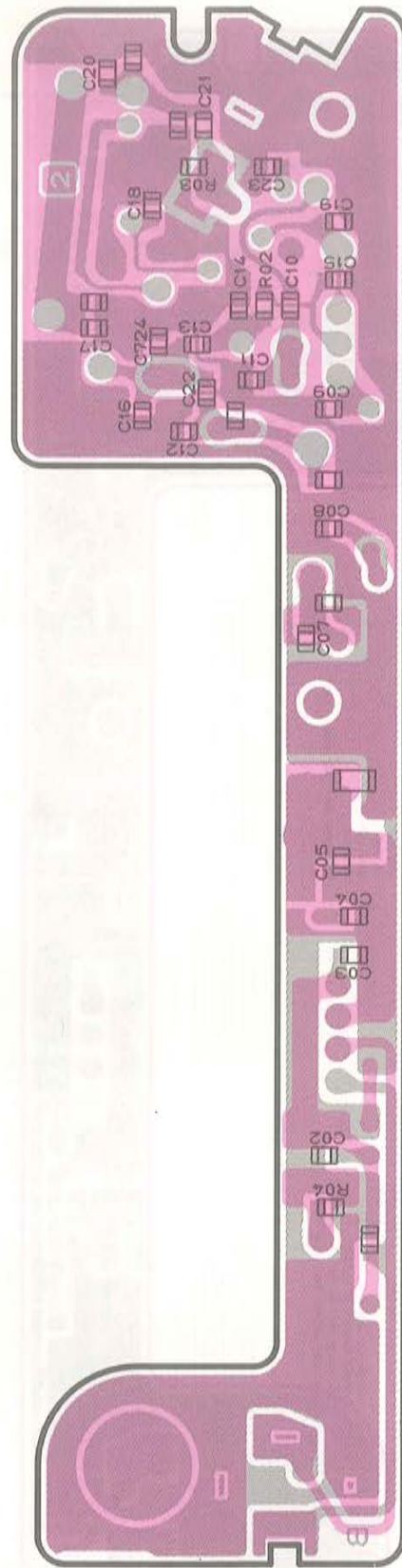

reverse view of "chip-only" side

PA UNIT CIRCUIT DIAGRAM

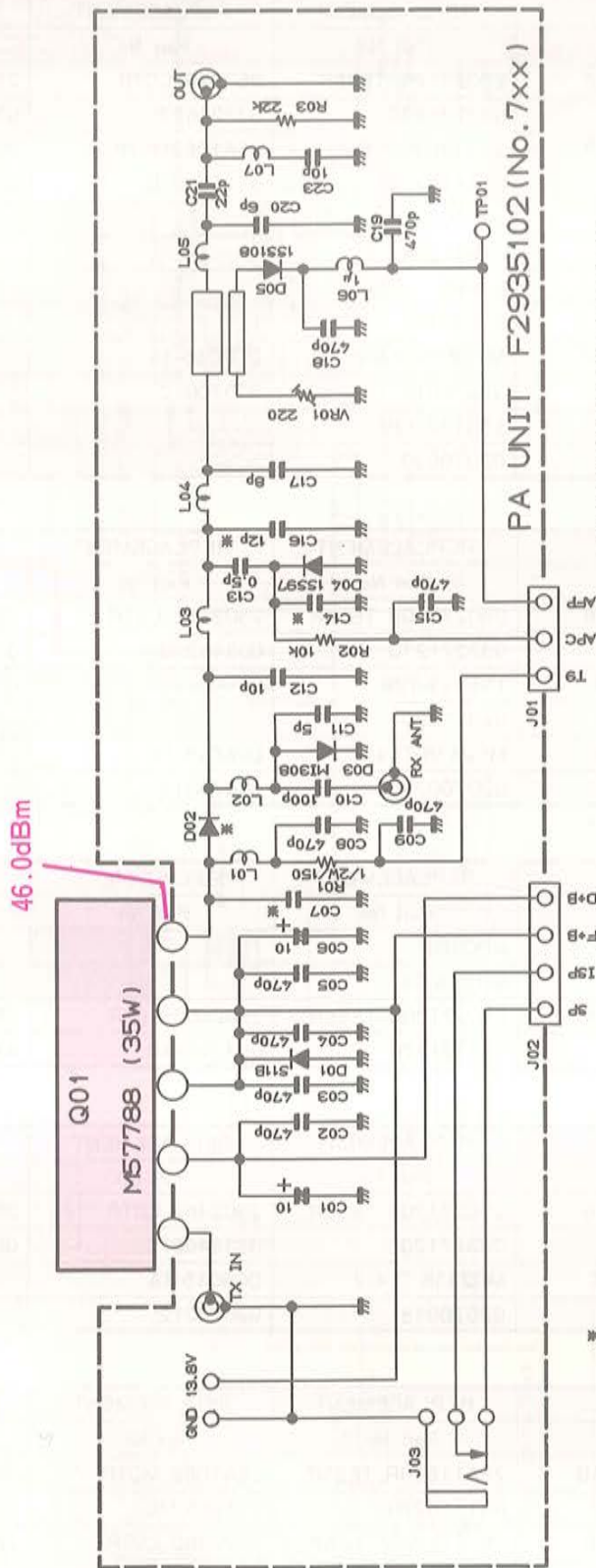

Q01	D02	C07	C14	C16
35W M57788	1N914	5p	2p	CERAMIC

SEMICONDUCTOR CROSS-REFERENCE

◎ MAIN UNIT

Symbol No.	ORIGINAL	REPLACEMENT	REPLACEMENT	REPLACEMENT
	Part No.	Part No.	Part No.	Part No.
Q1004,1006,1015	2SC1623-T2BL6	2SC2712GRTE85R	2SC2462LCTR	2SC2812L6TR
	G331623F	G3327127G	G3324627C	G3328127F
Q1005	2SA812T2BM7B	2SA1162GRTE85R	2SA1052MCTR	2SA1179M6TR
	G3108127G	G3111627G	G3110527C	G3111797E
Q1008	TDA2003	μ PC2002V		
	G1090769	G1090284		
Q1018	μ PC7805H	L7805		
	G1090299	G1090776		
D1001	1SS184TE85R	MC2838-T14-2	DCB015-TA	
	G2070009	G2070018	G2070012	
D1002	1SS226TE85R	1SS123-T2B		
	G2070003	G2070020		

◎ IF UNIT

Symbol No.	ORIGINAL	REPLACEMENT	REPLACEMENT	REPLACEMENT
	Part No.	Part No.	Part No.	Part No.
Q402	2SC1623-T2BL6	2SC2712GR TE85R	2SC2462 LCTR	2SC2812 L6TR
	G3316237F	G3327127G	G334627C	G3328127F
Q401	1SS226 TE85R	1SS123-T2B		
	G2070003	G2070020		
D402	1SS181 TE85R	MC2836-T14-2	DCA015-TA	
	G2070001	G2070024	G2070014	

◎ MIC UNIT

Symbol No.	ORIGINAL	REPLACEMENT	REPLACEMENT	REPLACEMENT
	Part No.	Part No.	Part No.	Part No.
Q501	LA6324M	μ PC324G		
	G1090559	G1090603		
Q503	2SC1623-T2BL6	2SC2712GR TE85R	2SC2462 LCTR	2SC2812 L6TR
	G3316237F	G3327127G	G3324627C	G3328127F

◎ APC UNIT

Symbol No.	ORIGINAL	REPLACEMENT	REPLACEMENT	REPLACEMENT
	Part No.	Part No.	Part No.	Part No.
Q602	2SC1623-T2BL6	2SC2712GR TE85R	2SC2462 LCTR	2SC2812 L6TR
	G3316237F	G3327127G	G3324627C	G3328127F
D601	1SS184 TE85R	MC2838-T14-2	DCB015-TA	
	G2070009	G2070018	G2070012	

◎ CONTROL UNIT

Symbol No.	ORIGINAL	REPLACEMENT	REPLACEMENT	REPLACEMENT
	Part No.	Part No.	Part No.	Part No.
Q2002	2SA812-T2BM6B	2SA1162GR TE85R	2SA1052 MCTR	2SA1179 M6TR
	G3108127F	G3111627G	G3110527C	G3111797E
Q2004,2006	2SC1623-T2BL6	2SC2712GR TE85R	2SC2462 LCTR	2SC2812 L6TR
	G3316237F	G3327127G	G3324627C	G3328127F
D2001	1SS226 TE85R	1SS123-T2B		
	G2070003	G2070020		
D2002,2003,2004 2005,2006,2007 2010	1SS184 TE85R	MC2838-T14-2	DCB015-TA	
	G2070009	G2070018	G2070012	

EXPLODED VIEW

SCREW LIST	
Ref.No.	Description
①	BINDING HEAD SCREW M2X5B
②	BINDING HEAD SCREW M2.6X5
③	FLAT HEAD SCREW M2.6X5
④	BINDING HEAD SCREW M2.6X6
⑤	BINDING HEAD SCREW M3X6
⑥	PAN HEAD SCREW M2.6X4

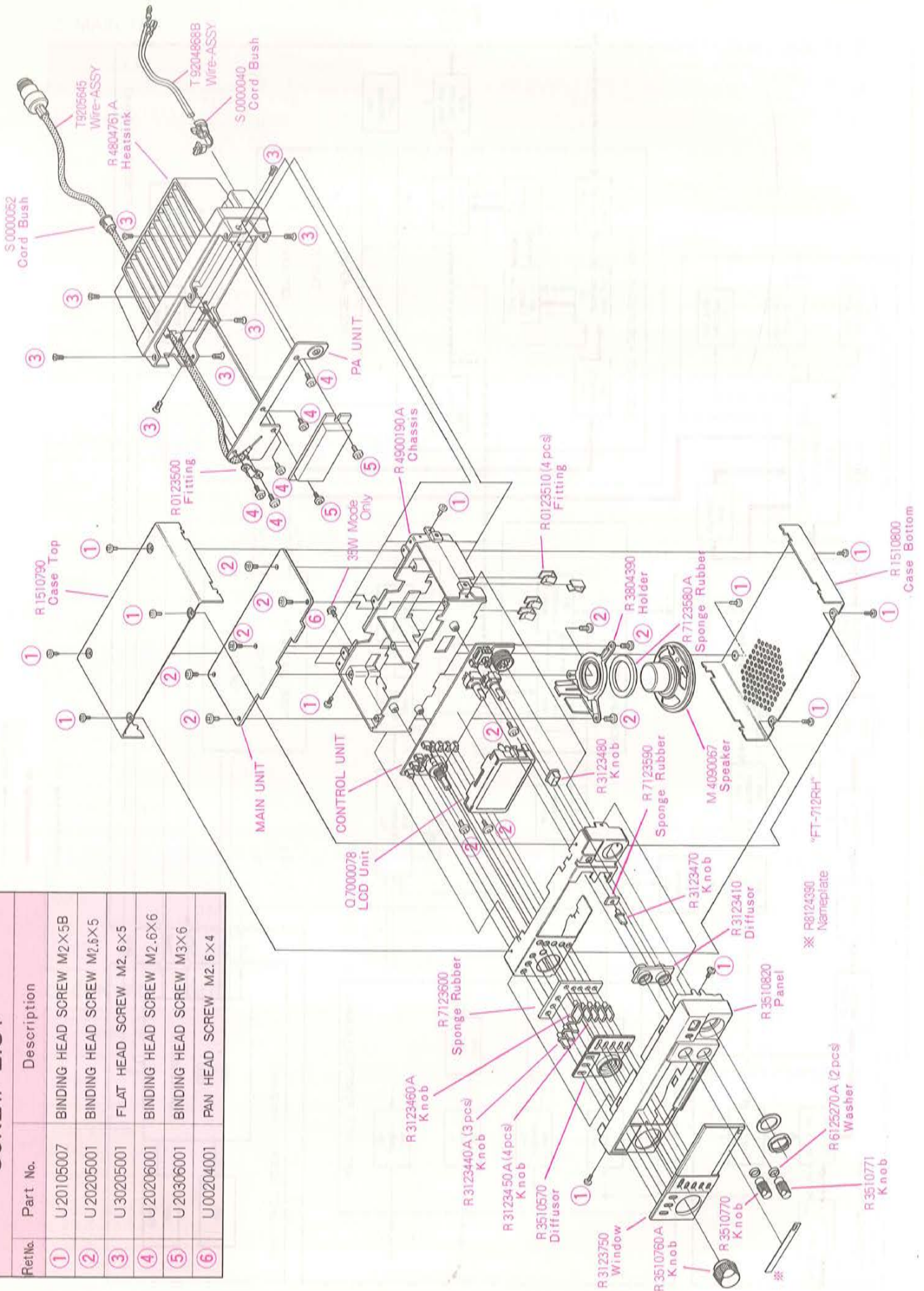

ALIGNMENT

The high reliability of the chip components in the FT-712RH minimize the possibility that repair or realignment should be needed after leaving the factory. However, if damage occurs and some parts subsequently be replaced, realignment may be required. If a sudden problem occurs during normal operation, it is likely due to component failure; realignment should not be done until after the faulty component has been replaced.

Because of the compact circuitry of this transceiver, we recommend that servicing be performed only by authorized Yaesu service technicians who are experienced with the circuitry and fully equipped for repair and alignment. Therefore, if a fault is suspected, contact the dealer from whom the transceiver was purchased for instructions regarding repair. Authorized Yaesu service technicians realign all circuits and make complete performance checks to ensure compliance with factory specifications after replacing any faulty components.

Those who do undertake any of the following alignments are cautioned to proceed at their own risk. Yaesu must reserve the right to change circuits and alignment procedures in the interest of improved performance, without notifying owners.

No alignment should be attempted unless the normal function and operation of the transceiver are clearly understood, the cause of the malfunction has been clearly pinpointed and any faulty components replaced, and the need for realignment determined to be absolutely necessary.

The following test equipment (and thorough familiarity with its correct use) is necessary for complete realignment. Correction of problems caused by misalignment resulting from use of improper test equipment is not covered under the warranty policy.

A 50-ohm dummy load that is non-reactive up to 500 MHz is required. Correct alignment is not possible with an antenna.

Alignment Equipment

DC voltmeter (at least 20-kilohms/volt)
500 MHz standard signal generator (SSG) with calibrated level and modulation (see note below)
AF signal generator
SINAD meter (SINADDER)
FM linear detector (deviation meter)
CM coupler (directional coupler)
RF wattmeter (50W, $\pm 5\%$ @ 500MHz)
50-ohm non-reactive (@500 MHz) dummy load
Frequency counter (100Hz resolution at 500MHz)
Oscilloscope (recommended, not required)

Note: SSG levels referred to in the alignment procedure are based on $0\text{dBu}=0.5\text{uV}$.

Alignment Precautions

Correct alignment requires that the ambient temperature be the same as that of the transceiver and test equipment, and that this temperature be held constant between 20 and 30 °C (68 to 86 °F). When the transceiver is brought into the shop it should be allowed at least 2 hours for thermal equalization before alignment.

Alignments must not be made unless the oscillator shields and circuit boards are firmly affixed in place. Also, the frequency counter must be thoroughly warmed up before beginning.

Supply voltage during alignment must be held constant at 13.8V DC. Use a well regulated, adjustable power supply capable of at least 10A continuous load.

ALIGNMENT (PLL)

A. PLL Unit

1) VCV (Varactor Control Voltage)

- a) With the dummy load connected to the ANT jack, connect the DC voltmeter (10V scale) to the VCV terminal on the VCO Unit.
- b) Tune the transceiver to 430 MHz (432 MHz for Version D), and while receiving, adjust TC301 on the VCO Unit for at least 0.8V (1.0V for Version D).

- c) Retune the transceiver to the frequency indicated below and adjust TC301 again, this time while transmitting, for the voltage indicated.

Version	Freq.	Voltage
A	450 MHz	8.0±0.2V
B, C, X	440 MHz	<7.5V
D	438 MHz	<7.0V

- d) Repeat steps b and c several times, and then remove the voltmeter.

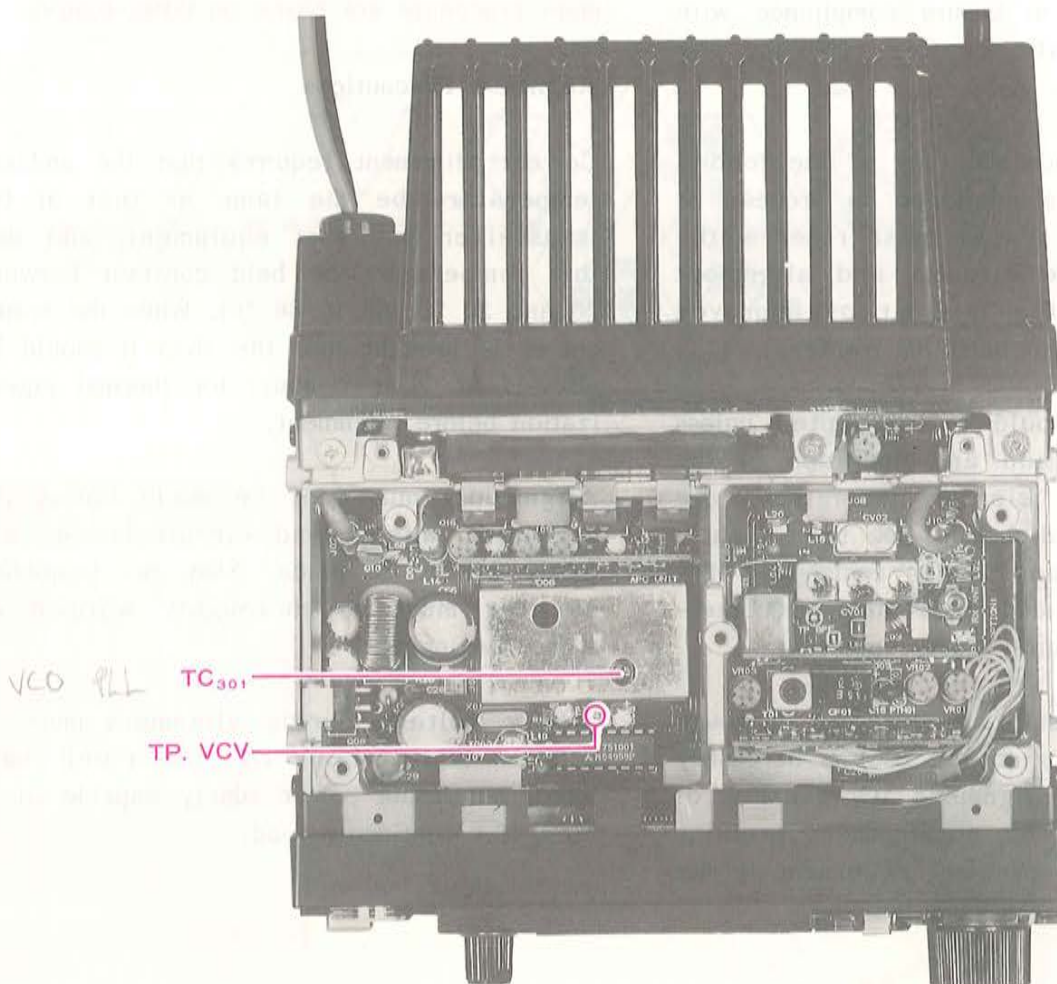

PLL ALIGNMENT POINTS

(Transmitter) ALIGNMENT

B. Transmitter

Set up the test equipment as shown in Figure 1. Close the PTT line when making adjustments. All adjustment points are on the Main Unit.

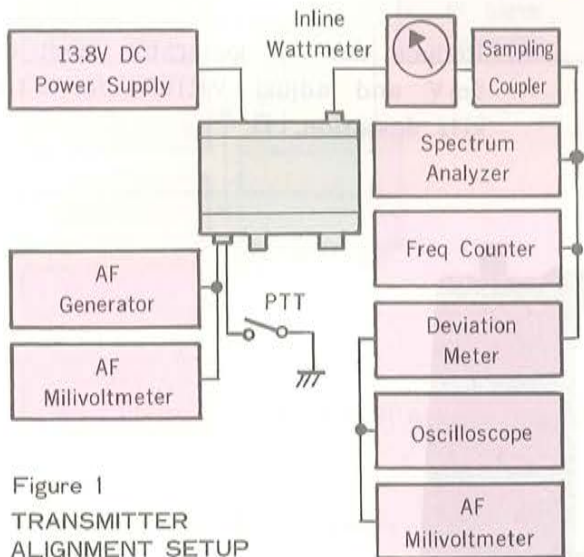

Figure 1
TRANSMITTER
ALIGNMENT SETUP

1) Early Stage Coupling

a) Tune the transceiver to the center of the band, and set the LOW button to the high power position.

b) Adjust L701 for maximum power output (at least 36 watts).

2) Power Output

a) With the transceiver tuned to the center of the band, set the LOW button to the high power position.

b) Connect the DC voltmeter to TP701 on the PA Unit.

c) Press the PTT switch and adjust VR701 for minimum on the voltmeter.

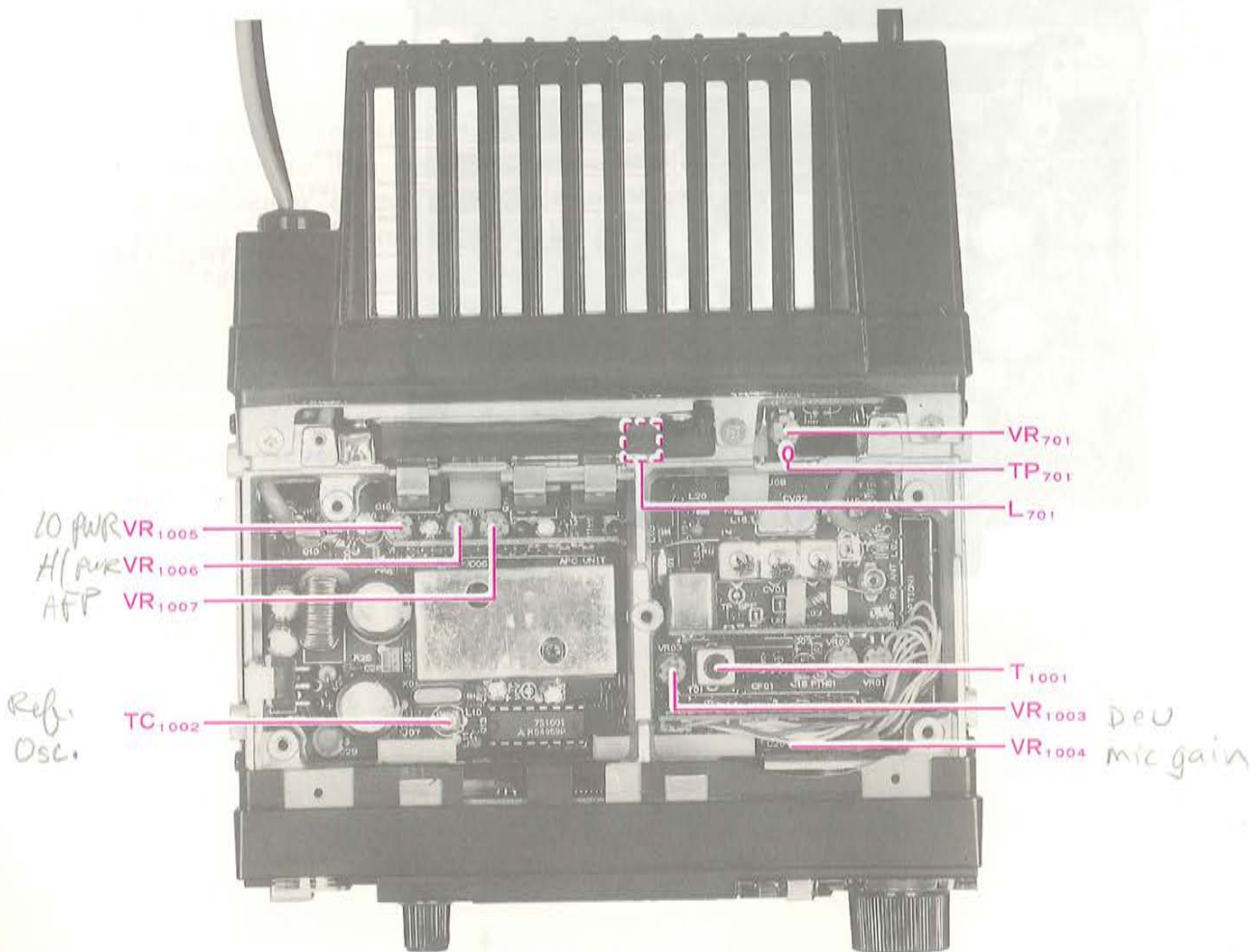

TRANSMITTER ALIGNMENT POINTS

ALIGNMENT (Transmitter)

d) Adjust VR1006 for 36 watts output.

e) Press the LOW switch and adjust VR1005 for 5W output.

3) Frequency Calibration

a) Adjust TC1002 to match the counter indication with the transceiver frequency.

4) Deviation

a) Set the AF generator for 25mV output at 1 kHz. Adjust VR1003 for ± 4.5 kHz deviation on the Deviation Meter. *Reduction*

b) Reduce the AF generator level to 5mV and adjust VR1004 for ± 3.5 kHz deviation. *mic gain*

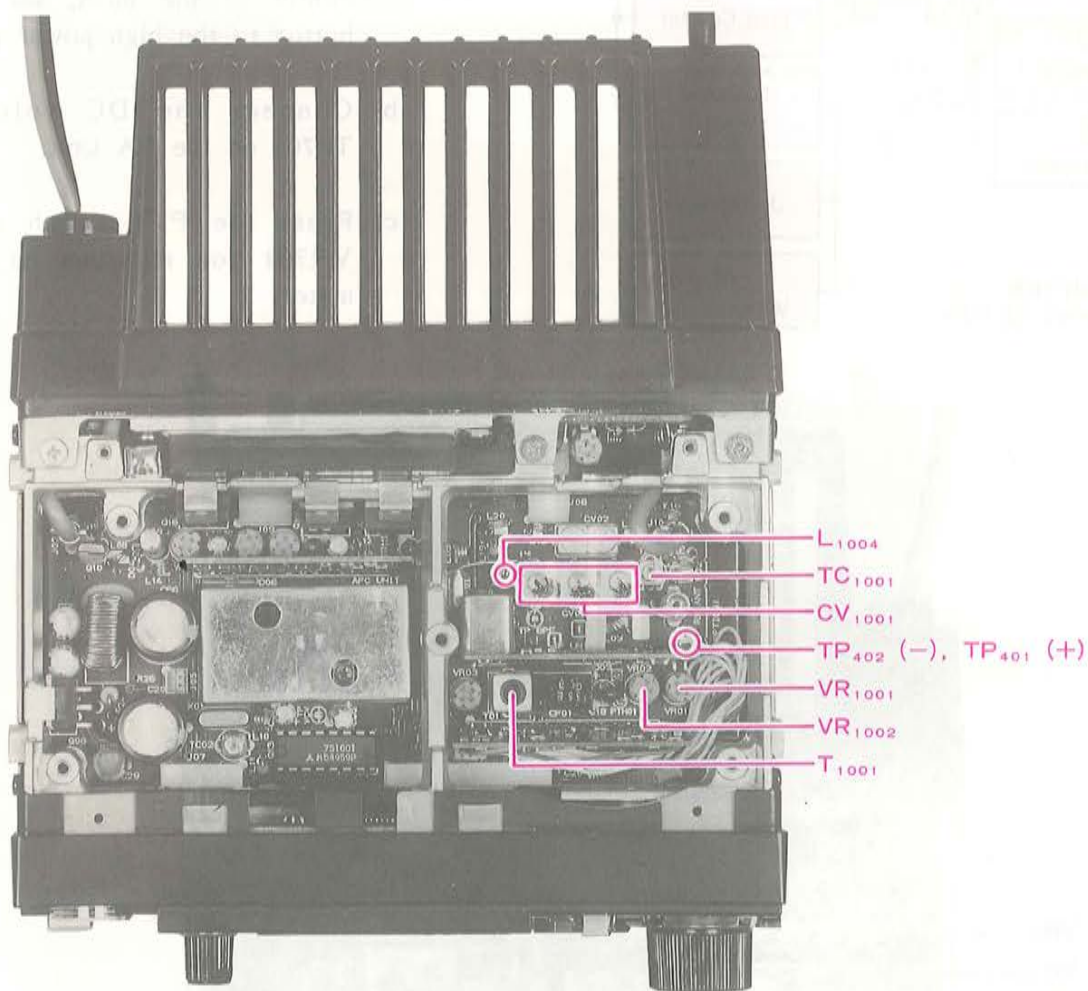

RECEIVER ALIGNMENT POINTS

C. Receiver

Set up the test equipment as shown in Figure 2. All adjustment points are on the Main Unit.

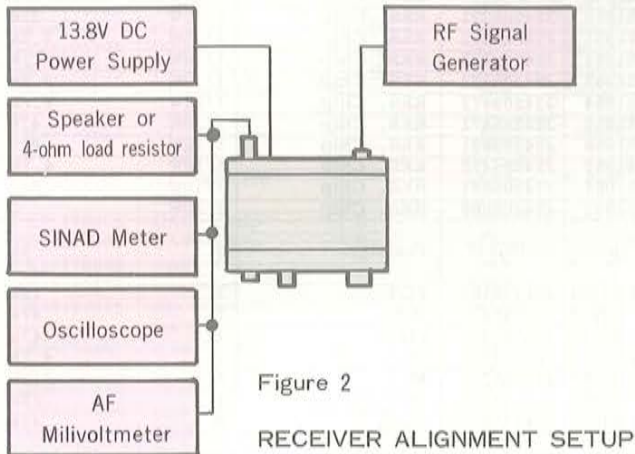

Figure 2

RECEIVER ALIGNMENT SETUP

1) Interstage Transformers

- a) Modulate the RF signal generator for ± 3.5 kHz deviation of a 1 kHz tone.
- b) Tune the transceiver and signal generator to the same frequency at the center of the band, and set the injection level to produce midrange S-meter indication.
- c) Adjust TC1001, L1004, T1001 and CV1001, in that order, for maximum S-meter indication. Reduce the injection level, if necessary, to keep the S-meter near midrange.

- d) Confirm 12dB SINAD sensitivity of -7.5dBu (0.21uV) or better on the SINADDER.

2) S-Meter Calibration

- a) At the center of the band, set the signal generator for 30dBu (50uV) injection with ± 3.5 kHz deviation of a 1 kHz tone.
- b) Adjust VR1002 so that all S-meter segments are just on.

3) Scanner Center-Stop

- a) Connect the DC voltmeter (3V range) between TP401 (+) and TP402 (-) on the IF Unit.
- b) Tune the transceiver to 435.000 or 445.000 MHz, and set the SQL fully counterclockwise (the BUSY lamp should be lit).
- c) Tune the signal generator to the same frequency, and inject 20dBu (5uV) with ± 3.5 kHz deviation of a 1 kHz tone.
- d) Adjust VR1001 for 0V on the voltmeter.

PARTS LIST

MAIN UNIT				
Symbol No.	Part No.	Description	Device	
	F2935101A	Printed Circuit Board		
	C029351AA	Without IF, MIC, APC, 430-VCO UNIT		
	C029351AB	With IF, MIC, APC, 430-VCO UNIT		
	C029351AC	Without IF, MIC, APC, 430-VCO UNIT		
	C029351AD	With IF, MIC, APC, 430-VCO UNIT		
Q1001	G4801647O	FET	3SK164-O-T7	
Q1002	G4801657O	FET	3SK165-O-T7	
Q1003	G3326207B	Transistor	2SC2620 QBTR	
Q1004	G3316237F	Transistor	2SC1623-T2BL6	
Q1005	G3108127G	Transistor	2SA812-T2BM7B	
Q1006	G3316237F	Transistor	2SC1623-T2BL6	
Q1007	G3410007L	Transistor	2SD1000-T2LL	
Q1008	G1090769	IC	TDA2003	
Q1009	G3333577	Transistor	2SC3357-T2	
Q1010	G3324071	Transistor	2SC2407(A)	
Q1011	G3333567D	Transistor	2SC3356-T2B R24	
Q1012	G3333567D	Transistor	2SC3356-T2B R24	
Q1013	G1090845	IC	M54959P	
Q1014	G3802087Y	FET	2SK208Y TE85R	
Q1015	G3316237F	Transistor	2SC1623-T2BL6	
Q1016	G3211340R	Transistor	2SB1134R	
Q1017	G1090778	IC	L7809	
Q1018	G1090299	IC	uPC7805H	
D1001	G2070009	Diode	1SS184 TE85R	
D1002	G2070003	Diode	1SS226 TE85R	
D1003	G2090027	Diode	1SS53	
D1004	G2015550	Diode	1S1555	
D1005	G2070044	Diode	HSM2693-TR	
D1006	G2090297	Diode	1SS110	
X1001	H0102856	XTAL	HC-43/U	12.8MHz
XF1001	H1102131	XTAL Filter	45M15A1	45MHz
CF1001	H3900200	Ceramic Filter	CFW455E	
R1001	J24205104	RES. Chip	1/10W	100k ohm
R1002	J24205682	RES. Chip	1/10W	6.8k ohm
R1003	J24205223	RES. Chip	1/10W	22k ohm
R1004	J24205680	RES. Chip	1/10W	68 ohm
R1005	J24205102	RES. Chip	1/10W	1k ohm
R1006	J24205100	RES. Chip	1/10W	10 ohm
R1007	J24205103	RES. Chip	1/10W	10k ohm
R1008	J24205000	RES. Chip	1/10W	0 ohm
R1009	J24205331	RES. Chip	1/10W	330 ohm
R1010	J24205101	RES. Chip	1/10W	100 ohm
R1011	J24205821	RES. Chip	1/10W	820 ohm
R1012	J24205102	RES. Chip	1/10W	1k ohm
R1013	J24205221	RES. Chip	1/10W	220 ohm
R1014	J24205682	RES. Chip	1/10W	6.8k ohm
R1015	J24205223	RES. Chip	1/10W	22k ohm
R1016	J24205471	RES. Chip	1/10W	470 ohm
R1017	J24205101	RES. Chip	1/10W	100 ohm
R1018	J24205472	RES. Chip	1/10W	4.7k ohm
R1019	J24205472	RES. Chip	1/10W	4.7k ohm
R1020	J24205000	RES. Chip	1/10W	0 ohm
R1022	J24205273	RES. Chip	1/10W	27k ohm
R1023	J24205471	RES. Chip	1/10W	470 ohm
R1024	J00275221	Carbon Film RES.	1/2W	220 ohm
R1025	J00275399	Carbon Film RES.	1/4W	3.9 ohm
R1026	J02245010	Carbon Film RES.	1/4W	1 ohm
R1027	J24205000	RES. Chip	1/10W	0 ohm
R1028	J24205472	RES. Chip	1/10W	4.7k ohm
R1029	J24205102	RES. Chip	1/10W	1k ohm
R1030	J24205150	RES. Chip	1/10W	15 ohm
R1031	J24205100	RES. Chip	1/10W	10 ohm
R1032	J24205470	RES. Chip	1/10W	47 ohm
R1033	J24205472	RES. Chip	1/10W	4.7k ohm
R1034	J24205100	RES. Chip	1/10W	10 ohm
R1035	J24205103	RES. Chip	1/10W	10k ohm
R1036	J24205104	RES. Chip	1/10W	100k ohm
R1037	J24205332	RES. Chip	1/10W	3.3k ohm
R1038	J24205150	RES. Chip	1/10W	15 ohm
R1039	J24205150	RES. Chip	1/10W	15 ohm
R1040	J24205150	RES. Chip	1/10W	15 ohm
R1041	J24205683	RES. Chip	1/10W	68k ohm
R1042	J24205471	RES. Chip	1/10W	470 ohm
R1044	J24205471	RES. Chip	1/10W	470 ohm
R1045	J24205471	RES. Chip	1/10W	470 ohm
R1046	J24205683	RES. Chip	1/10W	68k ohm
R1047	J24205472	RES. Chip	1/10W	4.7k ohm
R1048	J24205223	RES. Chip	1/10W	22k ohm
R1049	J24205223	RES. Chip	1/10W	22k ohm
R1050	J24205221	RES. Chip	1/10W	220 ohm
R1051	J24205222	RES. Chip	1/10W	2.2k ohm
R1052	J24205222	RES. Chip	1/10W	2.2k ohm
R1053	J24205222	RES. Chip	1/10W	2.2k ohm
R1054	J24205472	RES. Chip	1/10W	4.7k ohm
R1055	J24205471	RES. Chip	1/10W	470 ohm
R1056	J24205821	RES. Chip	1/10W	820 ohm
R1057	J24205472	RES. Chip	1/10W	4.7k ohm
R1064	J24205681	RES. Chip	1/10W	680 ohm
R1065	J24205000	RES. Chip	1/10W	0 ohm
PTH1001	G9090036	Posistor	J	3k ohm
VR1001	J51745103	POT.	B	10k ohm
VR1002	J51745473	POT.	B	47k ohm
VR1003	J51745473	POT.	B	47k ohm
VR1004	J51745472	POT.	B	4.7k ohm
VR1005	J51745222	POT.	B	2.2k ohm
VR1006	J51745223	POT.	B	22k ohm
VR1007	J51745473	POT.	B	47k ohm
C1003	K22170805	CAP. Chip	B	50V 0.001uF
C1004	K22170805	CAP. Chip	B	50V 0.001uF
C1005	K22170805	CAP. Chip	B	50V 0.001uF
C1006	K22170805	CAP. Chip	B	50V 0.001uF
C1007	K22170203	CAP. Chip	CH	50V 2pF
C1008	K22170203	CAP. Chip	CH	50V 2pF
C1009	K22170211	CAP. Chip	CH	50V 10pF
C1010	K22170204	CAP. Chip	CH	50V 3pF
C1011	K22170817	CAP. Chip	B	50V 0.01uF
C1012	K22170219	CAP. Chip	CH	50V 22pF
C1013	K22170805	CAP. Chip	B	50V 0.001uF
C1014	K22170805	CAP. Chip	B	50V 0.001uF
C1015	K22170817	CAP. Chip	B	50V 0.01uF
C1016	K22170817	CAP. Chip	B	50V 0.01uF
C1017	K22170817	CAP. Chip	B	50V 0.01uF
C1018	K70127106	Tantalum CAP.		16V 10uF
C1019	K22141809	CAP. Chip	B	25V 0.1uF
C1020	K40129012	AL. Electro. CAP.		16V 10uF
C1021	K70127475	Tantalum CAP.		16V 4.7uF
C1022	K22141809	CAP. Chip	B	25V 0.1uF
C1023	K22170805	CAP. Chip	B	50V 0.01uF
C1024	K40129038	AL. Electro. CAP.		16V 100uF
C1025	K22170805	CAP. Chip	B	50V 0.001uF
C1026	K40129038	AL. Electro. CAP.		16V 100uF
C1027	K22170805	CAP. Chip	B	50V 0.001uF
C1028	K40129021	AL. Electro. CAP.		16V 1000uF
C1029	K40129028	AL. Electro. CAP.		16V 47uF
C1030	K22141809	CAP. Chip	B	25V 0.1uF
C1031	K22141809	CAP. Chip	B	25V 0.1uF
C1032	K22170209	CAP. Chip	CH	50V 8pF
C1033	K22170805	CAP. Chip	B	50V 0.001uF
C1034	K22170805	CAP. Chip	B	50V 0.001uF
C1035	K22170208	CAP. Chip	CH	50V 7pF
C1036	K22170211	CAP. Chip	CH	50V 10pF
C1037	K22170805	CAP. Chip	B	50V 0.001uF
C1038	K22170805	CAP. Chip	B	50V 0.001uF
C1039	K22170208	CAP. Chip	CH	50V 7pF
C1040	K22170805	CAP. Chip	B	50V 0.001uF
C1041	K78100004	Tantalum. Chip		10V 10uF
C1042	K22170235	CAP. Chip	CH	50V 100pF
C1043	K22170204	CAP. Chip	CH	50V 3pF
C1044	K22170805	CAP. Chip	B	50V 0.001uF
C1045	K22170204	CAP. Chip	CH	50V 3pF
C1046	K22170207	CAP. Chip	CH	50V 6pF
C1047	K22170805	CAP. Chip	B	50V 0.001uF
C1048	K22170805	CAP. Chip	B	50V 0.001uF
C1049	K22170805	CAP. Chip	B	50V 0.001uF
C1050	K40129012	AL. Electro. CAP.		16V 10uF
C1051	K22170805	CAP. Chip	B	50V 0.001uF
C1052	K22170227	CAP. Chip	CH	50V 47pF

PARTS LIST

C1053	K22170223	CAP. Chip	CH	50V	33pF				
C1054	K22170805	CAP. Chip	B	50V	0.001uF				
C1055	K40179006	AL. Electro. CAP.		50V	2.2uF				
C1056	K22170805	CAP. Chip	B	50V	0.001uF				
C1057	K22140807	CAP. Chip	B	25V	0.022uF				
C1058	K78100004	Tantalum. Chip		10V	10uF				
C1059	K78160001	Tantalum. Chip		35V	0.1uF				
C1060	K78120002	Tantalum. Chip		16V	2.2uF				
C1061	K22170817	CAP. Chip	B	50V	0.01uF				
C1062	K78160003	Tantalum. Chip		35V	0.22uF				
C1063	K22170235	CAP. Chip	CH	50V	100pF				
C1064	K22170235	CAP. Chip	CH	50V	100pF				
C1065	K22170235	CAP. Chip	CH	50V	100pF				
C1066	K40129021	AL. Electro. CAP.		16V	1000uF				
C1067	K40129008	AL. Electro. CAP.		16V	33uF				
C1068	K40179007	AL. Electro. CAP.		50V	3.3uF				
C1069	K22170805	CAP. Chip	B	50V	0.001uF				
C1070	K22170805	CAP. Chip	B	50V	0.001uF				
C1071	K22170805	CAP. Chip	B	50V	0.001uF				
C1072	K70147475	Tantalum CAP.		25V	4.7uF				
C1073	K40129012	AL. Electro. CAP.		16V	10uF				
C1074	K22170805	CAP. Chip	B	50V	0.001uF				
C1075	K22170805	CAP. Chip	B	50V	0.001uF				
C1076	K70127106	Tantalum CAP.		16V	10uF				
C1077	K22170805	CAP. Chip	B	50V	0.001uF				
C1078	K22170805	CAP. Chip	B	50V	0.001uF				
C1091	K22170203	CAP. Chip	CH	50V	2pF				
C1092	K22170805	CAP. Chip	B	50V	0.001uF				
C1093	K22170817	CAP. Chip	B	50V	0.01uF				
C1094	K22170202	CAP. Chip	CH	50V	1pF				
TC1001	K91000167	Trimmer CAP.			3pF				
TC1002	K91000168	Trimmer CAP.			20pF				
L1002	L0020900	Coil							
L1003	L0020852	Coil							
L1004	L0021290	Coil							
L1005	L0021290	Coil							
L1006	L1190194	M. RFC							
L1007	L1690002	Coil. Chip							
L1008	L0020917	Coil							
L1009	L0021290	Coil							
L1010	L0021290	Coil							
L1011	L1190222	M. RFC							
L1013	L0021290	Coil							
L1014	L0021290	Coil							
L1015	L2190001	TOROID Coil			72uH				
CV1001	L4020081	Helical Resonator			440MHz				
T1001	L0021558	Coil			44.3MHz				
J1001	P1090210	Connector							
J1002	P1090210	Connector							
J1003	P0090648	Connector							
J1004	P0090647	Connector							
J1005	P0090647	Connector							
J1006	P1090602	Connector							
J1007	P1090601	Connector							
J1008	P0090640	Connector							
J1009	P0090641	Connector							
P1001	T9205642A	Wire-ASSY							
P1002	T9205638A	Wire-ASSY	JP1001						
IF UNIT									
Symbol No.	Part No.	Description	Device						
	F2937101A	Printed Circuit Board							
	C029371AB	PCB with Component							
Q401	G1090859	IC	TK10487M						
Q402	G3316237F	Transistor	2SC1623-T2BL6						
Q403	G1090846	IC	M5223FP						
D401	G2070003	Diode	1SS226TE85R						
D402	G2070001	Diode	1SS181TE85R						
X401	H0102858	XTAL	HC-49/T	44.545MHz					
CD401	H7900180	Ceramic DISC							CDB455C7
R401	J24205101	RES. Chip							1/10W 100 ohm
R402	J24205101	RES. Chip							1/10W 100 ohm
R403	J24205473	RES. Chip							1/10W 47k ohm
R404	J24205471	RES. Chip							1/10W 470 ohm
R405	J24205222	RES. Chip							1/10W 22k ohm
R406	J24205102	RES. Chip							1/10W 1k ohm
R407	J24205182	RES. Chip							1/10W 1.8k ohm
R408	J24205332	RES. Chip							1/10W 3.3k ohm
R409	J24205473	RES. Chip							1/10W 47k ohm
R410	J24205223	RES. Chip							1/10W 22k ohm
R411	J24205122	RES. Chip							1/10W 1.2k ohm
R412	J24205474	RES. Chip							1/10W 470k ohm
R413	J24205474	RES. Chip							1/10W 470k ohm
R414	J24205222	RES. Chip							1/10W 2.2k ohm
R415	J24205223	RES. Chip							1/10W 22k ohm
R416	J24205683	RES. Chip							1/10W 68k ohm
R417	J24205103	RES. Chip							1/10W 10k ohm
R418	J24205122	RES. Chip							1/10W 1.2k ohm
R419	J24205122	RES. Chip							1/10W 1.2k ohm
R420	J24205103	RES. Chip							1/10W 10k ohm
R421	J24205471	RES. Chip							1/10W 470 ohm
R422	J24205223	RES. Chip							1/10W 22k ohm
C401	K22170817	CAP. Chip	B	50V	0.01uF				
C402	K22170805	CAP. Chip	B	50V	0.001uF				
C403	K22170817	CAP. Chip	B	50V	0.01uF				
C404	K22170805	CAP. Chip	B	50V	0.001uF				
C405	K22170817	CAP. Chip	B	50V	0.01uF				
C406	K22170219	CAP. Chip	CH	50V	22pF				
C407	K22141809	CAP. Chip	B	25V	0.1uF				
C408	K22141809	CAP. Chip	B	25V	0.1uF				
C409	K22170233	CAP. Chip	CH	50V	82pF				
C410	K22170817	CAP. Chip	B	50V	0.01uF				
C411	K22141003	CAP. Chip	F	25V	0.047uF				
C412	K22170801	CAP. Chip	B	50V	470pF				
C413	K22170801	CAP. Chip	B	50V	470pF				
C414	K22170801	CAP. Chip	B	50V	470pF				
C415	K22170817	CAP. Chip	B	50V	0.01uF				
C416	K22141809	CAP. Chip	B	25V	0.1uF				
C417	K22170817	CAP. Chip	B	50V	0.01uF				
C418	K22170227	CAP. Chip	CH	50V	47pF				
L401	L1190227	M. RFC							0.33uH
TP401	Q5000096	Terminal							
MIC UNIT									
Symbol No.	Part No.	Description	Device						
	F2937102	Printed Circuit Board							
	C029372AB	PCB with Component							
Q501	G1090559	IC	LA6324M						
Q502	G1090831	IC	uPD4052BG						
Q503	G3316237F	Transistor	2SC1623-T2BL6						
Q504	G3070001	Transistor	FA1A4M-T2B						
Q505	G3070001	Transistor	FA1A4M-T2B						
Q506	G3070001	Transistor	FA1A4M-T2B						
R501	J24205472	RES. Chip							1/10W 4.7k ohm
R502	J24205684	RES. Chip							1/10W 680k ohm
R503	J24205472	RES. Chip							1/10W 4.7k ohm
R504	J24205472	RES. Chip							1/10W 4.7k ohm
R505	J24205682	RES. Chip							1/10W 6.8k ohm
R506	J24205822	RES. Chip							1/10W 8.2k ohm
R507	J24205684	RES. Chip							1/10W 680k ohm
R508	J24205472	RES. Chip							1/10W 4.7k ohm
R509	J24205472	RES. Chip							1/10W 4.7k ohm
R510	J24205472	RES. Chip							1/10W 4.7k ohm
R511	J24205333	RES. Chip							1/10W 33k ohm
R512	J24205562	RES. Chip							1/10W 5.6k ohm
R513	J24205225	RES. Chip							1/10W 2.2M ohm
R514	J24205472	RES. Chip							1/10W 4.7k ohm
R515	J24205154	RES. Chip							1/10W 150k ohm
R516	J24205824	RES. Chip							1/10W 820k ohm
R517	J24205823	RES. Chip							1/10W 82k ohm
R518	J24205472	RES. Chip							1/10W 4.7k ohm
R519	J24205224	RES. Chip							1/10W 220k ohm
R520	J24205103	RES. Chip							1/10W 10k ohm
R521	J24205102	RES. Chip							1/10W 1k ohm
R522	J24205102	RES. Chip							1/10W 1k ohm

PARTS LIST

R523	J24205104	RES. Chip	1/10W 100k ohm
R524	J24205104	RES. Chip	1/10W 100k ohm
R525	J24205104	RES. Chip	1/10W 100k ohm
R526	J24205104	RES. Chip	1/10W 100k ohm
R527	J24205394	RES. Chip	1/10W 390k ohm
R528	J24205274	RES. Chip	1/10W 270k ohm
R529	J24205223	RES. Chip	1/10W 22k ohm
R530	J24205273	RES. Chip	1/10W 27k ohm
R531	J24205224	RES. Chip	1/10W 220k ohm
R532	J24205103	RES. Chip	1/10W 10k ohm
R533	J24205103	RES. Chip	1/10W 10k ohm
R534	J24205153	RES. Chip	1/10W 15k ohm
R535	J24205222	RES. Chip	1/10W 2.2k ohm
R536	J24205222	RES. Chip	1/10W 2.2k ohm
R537	J24205564	RES. Chip	1/10W 560k ohm
R538	J24205393	RES. Chip	1/10W 39k ohm
R539	J24205393	RES. Chip	1/10W 39k ohm
R540	J24205223	RES. Chip	1/10W 22k ohm
R541	J24205823	RES. Chip	1/10W 82k ohm

C501	K22170817	CAP. Chip	B	50V	0.01uF
C502	K22141809	CAP. Chip	B	25V	0.1uF
C503	K22170805	CAP. Chip	B	50V	0.001uF
C504	K78120009	Tantalum. Chip		16V	1uF
C505	K22141809	CAP. Chip	B	25V	0.1uF
C506	K22141809	CAP. Chip	B	25V	0.1uF
C507	K22170817	CAP. Chip	B	50V	0.01uF
C508	K22170817	CAP. Chip	B	50V	0.01uF
C509	K22170805	CAP. Chip	B	50V	0.001uF
C510	K22170817	CAP. Chip	B	50V	0.01uF
C511	K22140807	CAP. Chip	B	25V	0.022uF
C512	K22170243	CAP. Chip	CH	50V	220pF
C513	K22140807	CAP. Chip	B	25V	0.022uF
C514	K22141809	CAP. Chip	B	25V	0.1uF
C515	K22140807	CAP. Chip	B	25V	0.022uF
C516	K22140807	CAP. Chip	B	25V	0.022uF
C517	K22140807	CAP. Chip	B	25V	0.022uF
C518	K22170805	CAP. Chip	B	50V	0.001uF
C519	K22141809	CAP. Chip	B	25V	0.1uF
C520	K22141806	CAP. Chip	B	25V	0.033uF
C521	K22141809	CAP. Chip	B	25V	0.1uF

APC UNIT

Symbol No.	Part No.	Description	Device
	F2937103A	Printed Circuit Board	
	C029373AA	PCB with Component	
Q601	G3070008	Transistor	FMS1 T98
Q602	G3316237F	Transistor	2SC1623-T2B L6
Q603	G3206247D	Transistor	2SB624-T2B BV4
Q604	G3206247D	Transistor	2SB624-T2B BV4
Q605	G3070009	Transistor	FMW1T98
Q606	G3070001	Transistor	FA1A4M-T2B

D601	G2070009	Diode	1SS184TE85R
D602	G2070048	Diode	1SS272TE85R
R601	J24205103	RES. Chip	1/10W 10k ohm
R602	J24205103	RES. Chip	1/10W 10k ohm
R603	J24205103	RES. Chip	1/10W 10k ohm
R604	J24205104	RES. Chip	1/10W 100k ohm
R605	J24205102	RES. Chip	1/10W 1k ohm
R606	J24205471	RES. Chip	1/10W 470 ohm
R607	J24205102	RES. Chip	1/10W 1k ohm
R608	J24205102	RES. Chip	1/10W 1k ohm
R609	J24205103	RES. Chip	1/10W 10k ohm
R610	J24205102	RES. Chip	1/10W 1k ohm
R611	J24205102	RES. Chip	1/10W 1k ohm
R612	J24205471	RES. Chip	1/10W 470 ohm
R613	J24205103	RES. Chip	1/10W 10k ohm
R614	J24205472	RES. Chip	1/10W 4.7k ohm
R615	J24205103	RES. Chip	1/10W 10k ohm
R616	J24205101	RES. Chip	1/10W 100 ohm

C601	K22170805	CAP. Chip	B	50V	0.001uF
C602	K22170809	CAP. Chip	B	50V	0.1uF
C603	K22170805	CAP. Chip	B	50V	0.001uF
C604	K22170805	CAP. Chip	B	50V	0.001uF
C605	K22170235	CAP. Chip	CH	50V	100pF
C606	K22170805	CAP. Chip	B	50V	0.001uF
C607	K22170805	CAP. Chip	B	50V	0.001uF

430-VCO UNIT

Symbol No.	Part No.	Description	Device
	F2939101A	Printed Circuit Board	
	C029391AA	PCB with Component	
Q301	G3333567D	Transistor	2SC3356-T2B R24
Q302	G3801250	FET	2SK125
D301	G2090027	Diode	1SS53
D302	G2070040	Diode	1T33-T7
D303	G2070040	Diode	1T33-T7
R301	J24205150	RES. Chip	1/10W 15 ohm
R302	J24205101	RES. Chip	1/10W 100 ohm
R303	J24205101	RES. Chip	1/10W 100 ohm
R304	J24205222	RES. Chip	1/10W 2.2k ohm
R305	J24205103	RES. Chip	1/10W 10k ohm
R306	J24205103	RES. Chip	1/10W 10k ohm
R307	J24205330	RES. Chip	1/10W 33 ohm
R308	J02225680	Carbon Film RES.	1/6W 68 ohm

C301	K22170805	CAP. Chip	B	50V	0.001uF
C302	K22170805	CAP. Chip	B	50V	0.001uF
C303	K22170805	CAP. Chip	B	50V	0.001uF
C304	K22170201	CAP. Chip	CH	50V	0.5pF
C305	K22170206	CAP. Chip	CH	50V	5pF
C306	K22170209	CAP. Chip	CH	50V	8pF
C307	K22170201	CAP. Chip	CH	50V	0.5pF
C308	K22170201	CAP. Chip	CH	50V	0.5pF
C309	K22170805	CAP. Chip	B	50V	0.001uF
C310	K40129038	AL. Electro. CAP.		16V	100uF
C311	K22170227	CAP. Chip	CH	50V	47pF
C312	K22170805	CAP. Chip	B	50V	0.001uF
C313	K22170805	CAP. Chip	B	50V	0.001uF

TC301	K91000167	Trimmer CAP.			3pF
-------	-----------	--------------	--	--	-----

L301	L1190192	M. RFC			0.47uH
L302	L0021520	Coil			
L303	L1190192	M. RFC			0.47uH
L304	L1190192	M. RFC			0.47uH
L305	F2896000	P.C.B. w/o COMP.			

FB301	L9190001	Ferrite Beads			
FB302	L9190001	Ferrite Beads			

P301	P0090473	Connector			
	R0123490	Shield Case			

CONTROL UNIT

Symbol No.	Part No.	Description	Device
	F2936101A	Printed Circuit Board	
	C029361AF	PCB with Component (Version A)	
	C029361AG	PCB with Component (Version B)	
	C029361AH	PCB with Component (Version C)	
	C029361AJ	PCB with Component (Version D)	
	C029361AK	PCB with Component (Version F)	
	C029361AL	PCB with Component (Version X)	
Q2001	G1090812	IC	PST523C-2
Q2002	G3108127F	Transistor	2SA812-T2BM6B
Q2003	G1090847	IC	HD404418A01F
Q2004	G3316237F	Transistor	2SC1623-T2B L6
Q2005	G3206247D	Transistor	2SB624-T2B BV4
Q2006	G3316237F	Transistor	2SC1623-T2B L6



