

OPERATING MANUAL

FT-912R



YAESU MUSEN CO., LTD.
C.P.O. BOX 1500
TOKYO, JAPAN

Contents

Supplied Accessories	2	Priority Channel Monitoring	18
Options	2	Tone Squelch Operation	19
Specifications	3	DVS-1 Digital Voice System	
General	3	(Option)	20
Receiver	3	General Description	20
Transmitter	3	Voice System Display	20
Controls & Connectors	4	Recording Mode ("S" or "M")	21
Front Panel	4	Bit Rate ("1" - "4")	21
Rear Panel	6	Segmentation Code	
Installation	7	("0" - "9" or "A" - "F")	21
Antenna Considerations	7	Play Lock ("L" or blank)	22
Mobile Installation	7	Starting Segment ("1" - "8")	22
Mobile Power Connections	8	Rec Lock ("L" or blank)	22
External Accessories	9	Seg Code Selection Notes	22
Base Station Installation	10	Recording	22
Operation	11	On-The-Air Rec & Playback	24
Preliminary Operating		Remote Record & Playback	24
Information	11	Locking Segments	26
Squelch Setup	11	Private Station ID Code	26
Tuning	12	CAT System External	
Tuning Step Size	12	Computer Control	28
Transmitting	13	Interconnections	28
Repeater Splits	13	Data Format	28
Memory Storage	14	Programming	29
Storing Rptr Frequency Pairs	15	In Case of Problems	31
Memory Recall	15	Installation of Options & Modifications	
Hiding & Erasing Memories	15	DVS-1 Digital Voice System	
Scanning	16	Installation	32
Memory Skip Scanning	17	FTS-12 Tone Squelch Unit	
Programmable Memory		Installation	33
Scanning (PMS)	17	Memory Cloning	35
		Modification for Packet Radio	36

Yaesu FT-912R

Compact 1300-MHz FM Mobile Transceiver

The FT-912R is a compact, full-featured frequency synthesized FM mobile/base transceiver providing selectable power output of 1 or 5 and 10 watts on the 23-cm amateur band. Unique features include the optional DVS-1 Digital Voice System, which provides local and remote digital voice recording and playback when installed in the FT-912R.

Inside the FT-912R, surface-mount components provide high reliability and performance, while modular circuit construction makes servicing easy. A compartmentalized die-cast chassis provides superb rf isolation and incredible overall ruggedness. A large liquid crystal display includes a bargraph PO/S-meter. Ambient light is sensed to automatically control the brightness of the display back-lighting and pilot lamps, dimming the display in dark environments.

Operating features include memory selection and tuning in 10-, 12.5-, 20- and 25-kHz selectable steps; eighteen general purpose memories, a one-touch recall Call channel memory and two subband limit memories (for programmable subband scanning); one-touch repeater reverse; band and selected memory scanning with auto-resume after carrier-drop or 5-second pause, and priority channel monitoring. Memory hiding and scan-skip are easily settable.

Nineteen of the memories store either programmable repeater shift or independent transmit and receive frequencies. Any of 37 standard CTCSS (subaudible) tone frequencies (plus 97.4 Hz) can be displayed, selected and programmed into any memory channel for transmission, and when the optional FTS-12 Unit is installed, for silent monitoring.

The microphone jack includes signals for CAT System control from an external personal computer, and memory cloning to/from other FT-912Rs. A 1750-Hz burst tone generator is built in and can be activated from the MH-14A8 Speaker/Mic. DTMF keypad microphone options include the MH-15C8 and the MH-15D8 with its own auto-dial DTMF memories. If

the burst tone is not needed, an internal jumper can be set to allow packet radio tnc interfacing via the microphone jack.

Along with one microphone, the MMB-37 Reversible Mobile Bracket is supplied with the transceiver. For base station installations, the FP-700 AC Power Supply/External Speaker is optionally available.

Please read this manual before installing or operating the FT-912R.

Supplied Accessories

MMB-37 Mobile Mounting Bracket D6000056
Power Supply Cable T9015615 with two 15A fuses, 2.8m
One of the microphones listed below.

Options

Model		Order Code
DVS-1	Digital Voice Memory Unit	D3000567
FTS-12	Tone Squelch Unit	D3000488
SP-55	External Speaker	
MH-14A8	Hand Speaker/Mic w/Burst Button	D1000051
MH-14B8	Hand Speaker/Mic	D1000052
MH-14D8	Standard Hand Mic	D1000067
MH-15C8	Hand Speaker/Mic w/DTMF keypad	D1000060
MH-15D8	Hand Mic w/DTMF Autodialler Memory	D1000061
MF-1A3B	Boom Microphone with flexible arm	
YH-1	Headset (w/microphone)	
SB-10	PTT Switch Unit for MF-1A3B or YH-1	

Some options may be provided as standard accessories in some countries, and some may be unavailable where restricted by local laws and customs. Ask your Yaesu dealer for specific details.

Specifications

General

Frequency range:	1240 – 1300 MHz
Channel steps:	user-selectable from 10, 12.5, 20 and 25 kHz
Repeater shift:	programmable
Mode of emission:	G3E
Antenna impedance:	50 ohms, unbalanced
Supply voltage:	13.8 V DC \pm 10%, negative ground
Supply current:	5 A transmit (for 10 watts output); 660 mA receive; 500 mA standby
Operating temperature range:	-20 to +60 °C
Frequency accuracy:	\pm 1.5ppm (-5 to +50 °C)
Case size (WHD):	140 \times 40 \times 160 mm
Weight:	Approximately 1.25 kg

Receiver

Circuit type:	Double-conversion superheterodyne
Intermediate frequencies:	58.3 MHz & 455 kHz
Sensitivity (for 12dB SINAD):	better than 0.25 mV
Image ratio:	better than 50 dB
Selectivity (-6/-60dB):	12/30 kHz
Audio Output (for 5% THD):	at least 1.5 watts into 8 ohms

Transmitter

RF output power (50 ohms):	1 or 5 and 10 watts
Modulation method:	Variable reactance
Maximum deviation:	\pm 5 kHz
Spurious emissions:	at least 50 dB below carrier
Microphone impedance:	2 kilohms

Specifications subject to change, in the interest of technical improvements, without notice or obligation.

Controls & Connectors

Front Panel

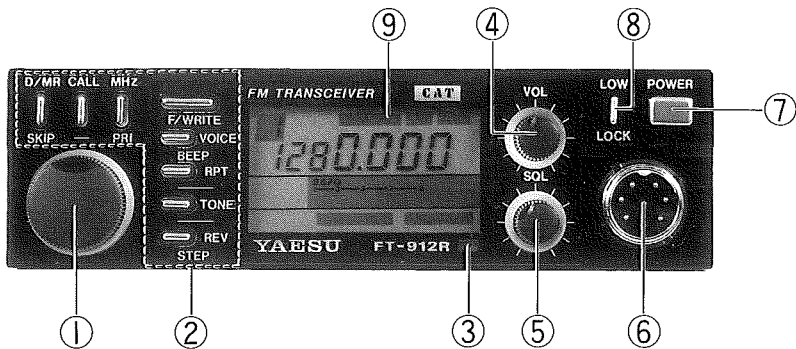

(1) Selector Knob

This 24-position detented rotary switch is used for tuning as well as a wide variety of function selections. The **DWN** and **UP** keys on the microphone duplicate the functions of this knob.

(2) Push Button Switches

These push buttons select the various operating features. One or more beeps will sound if the resulting command is accepted (beep notes are shown on page 10). The white labels above or to the right of the buttons indicate their primary functions, while the blue labels below the buttons indicate alternate functions, activated by pressing the **F/WRITE** button momentarily first, and then the other button within five seconds.

For descriptive purposes in this manual, alternate button functions are referenced by the blue label (or the white label, if there is no blue one), with "**F +**" in front of it to remind you to press **F/WRITE** first. For example, "**F + BEEP**" indicates that you should press the **F/WRITE** button followed by the **VOICE/BEEP** button (within five seconds). All button functions are described in detail in the "Operation" section, and summarized in the *FT-912R Operator's Quick Reference Charts*.

(3) Auto Dimmer Sensor

Behind the glass is a photosensor which detects the level of ambient light, causing the display lamps to be automatically dimmed in the dark.

(4) VOL Control

This control adjust the volume of the receiver audio.

(5) SQL Control

This control sets the threshold level at which received signals (or noise) open the squelch. For maximum squelch sensitivity set this control from counter-clockwise just to the point where noise is silenced (and the **BUSY** indicator on the display is off) when the channel is clear.

(6) Microphone Jack

This 8-pin jack accepts microphone input and scanning control from the microphone and/or control signals from an external computer. Memory cloning can be performed with another transceiver through this jack, and an internal modification also allows packet radio tnc connection here.

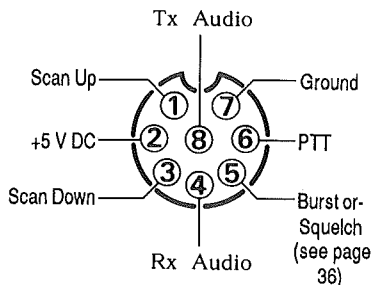

(7) POWER Switch

This two-position push button turns the transceiver on and off.

(8) LOW/LOCK Button

Normally, this button toggles between high and low transmitter power output. When low power is selected, two low-pitched beeps sound (♪), and “**LOW**” appears at the lower right corner of the display. Two high-pitched beeps sound (♪) when high power is selected.

If the **F/WRITE** button is pressed just before pressing the **LOW/LOCK** button, transmitter power is not changed, but rather low/high beeps sound (♪), and “**LOCK**” appears in reverse letters at the lower left corner of the display, indicating that the selector knob and all other buttons are now disabled. Pressing **F + LOCK** again sounds high/low beeps (♪) as the lock condition is released.

(9) Display

The display segments are shown in the diagram on the next page. The meaning of each is described in the “Operation” section.

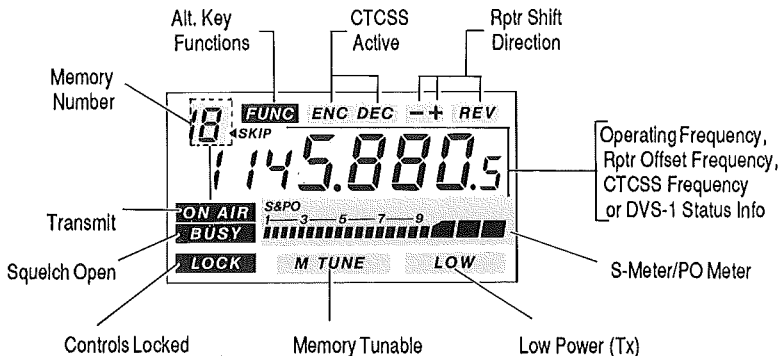

Rear Panel

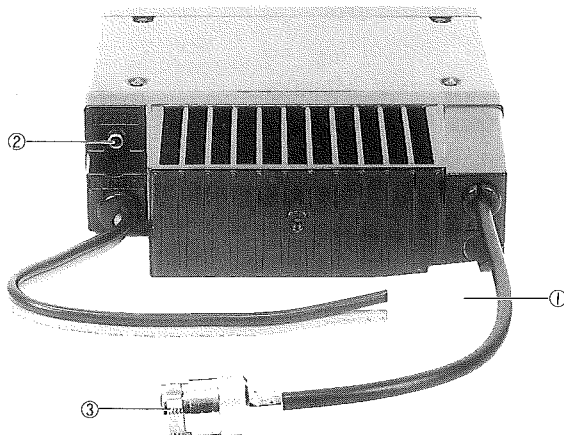

(1) 13.8VDC Cable Pigtail

Use the supplied fused DC Cable to connect this pigtail to the car battery or other DC power supply capable of at least 10 amperes (continuous). Make sure the RED lead connects to the POSITIVE side of the supply.

(2) EXT SP (External Speaker) Jack

This 2-contact mini phone jack accepts a 4- to 16-ohm external speaker such as the Yaesu SP-3, SP-4 or SP-55. When a plug is inserted into this jack the internal speaker is disabled.

(3) ANT (Antenna) Cable Pigtail

Connect a 23-cm-band antenna to this type-NS in-line socket using 50-ohm coaxial cable and a type-NP plug. Make sure the antenna is designed specifically for use at the operating frequency.

Installation

Antenna Considerations

The FT-912R is designed for use with an antenna having an impedance near 50 ohms at the operating frequency. For optimum performance use a high-quality, carefully designed antenna. The antenna should be connected at all times when power is on, to avoid damage that can otherwise result if transmission occurs accidentally when no antenna is connected.

Another important consideration is the feedline. For optimum performance use the shortest possible length of the largest diameter and best quality coaxial cable available, and be sure to use a properly matching plug (type-NP) for the jack on the transceiver. Typical attenuation of 10 feet RG-58/U cable at 1300 MHz is 3 dB or more, meaning about half of the power is lost in this length of cable.

Mobile Installation

The FT-912R must only be installed in cars having a negative ground electrical system. The transceiver should be mounted where the display, controls and microphone are easily accessible, using the supplied MMB-37 mobile mounting bracket. It may be installed in any position without affecting performance, but should not be near a heater vent or where it could interfere with driving. Make sure there is plenty of space provided at the rear of the transceiver so that air can flow freely around the heatsink.

- After selecting the mounting location, use the bracket as a template to locate the mounting holes, and use a 4.8-mm ($\frac{3}{16}$ ") bit to drill the holes. Secure the bracket with the supplied screws, washers and nuts (see right).
- Screw the two mounting clips to the sides of the transceiver using the small hex bolts and washers supplied, as shown at the top of the next page.

To install the transceiver, position the transceiver in the bracket so that the clip on the left side

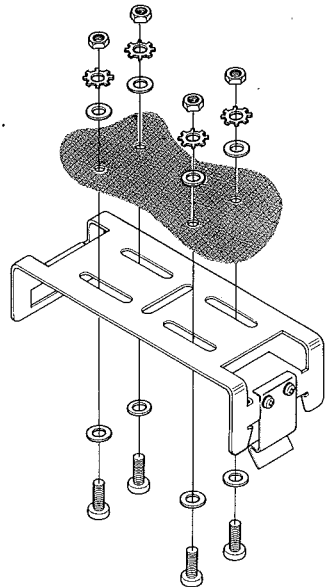

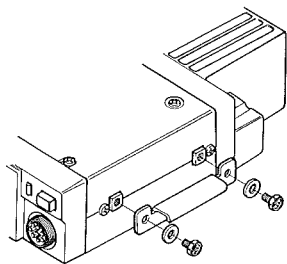

fits into the slot in the left side of the bracket (see below), then push the right side of the transceiver upwards until it latches.

To remove the transceiver place your hand underneath it and pull the latch on the right side of the bracket outward until the right side drops free. Then slide the transceiver slightly to the right to unhook the left side.

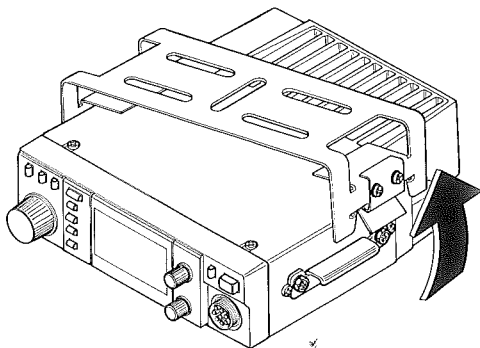
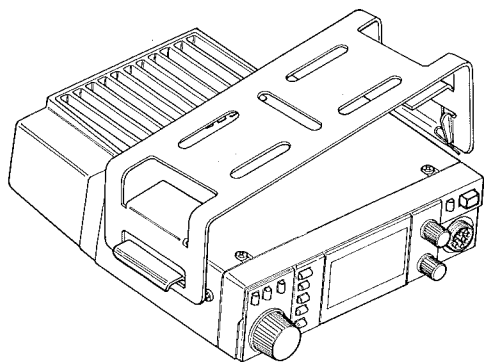

Mobile Power Connections

Before connecting the power cable, the maximum battery charging voltage should be checked to ensure that it remains below 15V when the engine is run fast. If more than 15V, the voltage regulator of the car should be adjusted before connecting the transceiver.

Power connections should be made directly to the automobile battery using the supplied cable with 15-Amp in-line fuses. Connection to the cigarette lighter or other accessory circuit may cause the fuse to blow in that circuit. Connecting the supplied DC power cable to the battery independently of the rest of the automobile electrical system will minimize possible ignition noise pickup and excessive supply voltage drop during transmission, while allowing operation with the ignition off.

Do not connect any power to the transceiver except via the supplied fused cable, and do not attempt to defeat or bypass the fuses — they are there to protect you and the equipment.

Connect the RED lead of the power cable to the POSITIVE (+) battery terminal, and the BLACK lead to the NEGATIVE (-) terminal. If it is necessary to extend the power cable, use #14 AWG or larger insulated, stranded copper wire, and in all cases use the minimum power cable length practicable to keep voltage drop minimal.

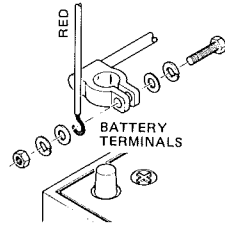

CAUTION!

Never apply AC power to the rear panel power jack of the transceiver. Never connect DC voltage of more than 15 volts to the power jack. Always replace fuses with 15A rating. Failure to observe these precautions will void the warranty.

External Accessories

The SP-3, SP-4 and SP-55 External Speakers are optional accessories which allow the source of audio from the transceiver to be repositioned for optimum hearing. Especially practical for the noisy mobile environment, each includes its own swivel-type mounting bracket, and is available from your Yaesu dealer. Also available to enhance safety and mobile operating convenience are the YH-1 Headset with miniature boom microphone, and the full size MF-1A3B boom microphone with flexible arm (both of which use the SB-10 PTT switch).

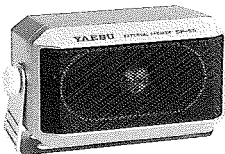

SP-55

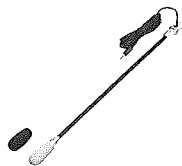

MF-1A3B



YH-1



SB-10

Base Station Installation

A power supply capable of providing at least 5 amperes continuously at 13.8VDC is required for operation from the AC line, and an external speaker is recommended. The FP-700 AC power supply is available from your Yaesu dealer for this purpose. Use the fused DC power cable supplied with the transceiver for making power connections, and connect the external speaker to the **EXT SP** jack on the rear panel.

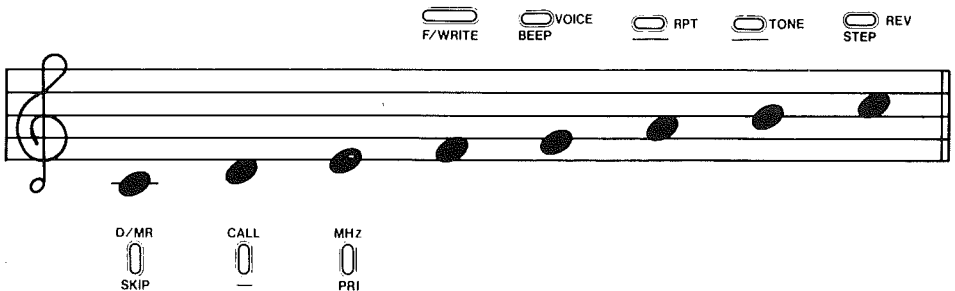

Pushbutton Beep Scale

Operation

This chapter describes the various transceiver functions in detail. After studying these descriptions, keep the *FT-912R Operator's Quick Reference Charts* handy in case you need to refresh your memory.

Preliminary Operating Information

Before operating the transceiver, recheck power supply and antenna connections. Never operate the transceiver without an antenna. Also, please read the chapter on Controls & Connectors, if you have not already, to familiarize yourself with the functions of the controls. Note especially the description on page 4 of the terminology used in this chapter when referring to the buttons.

When the buttons are pressed during reception, one or more beeps will sound if the command is accepted. Except for certain special cases mentioned later, the buttons are disabled during transmission.

If you have trouble getting the transceiver to work as described, see *In Case of Problems* on page 31.

Squelch Setup

Before turning on the transceiver for the first time:

- Preset the **VOL** and **SQL** controls fully counterclockwise.
- Press the **POWER** button and adjust the **VOL** control for a comfortable volume on the noise or received signal. "**BUSY**" should be displayed in reverse letters to the left of the **S&PO** meter scale.
- If a signal is present, rotate the selector knob until a frequency is found where only noise is heard.
- Turn the **SQL** knob clockwise just to the point where the noise is silenced and "**BUSY**" disappears (if the **SQL** is set further clockwise, sensitivity to weak signals is reduced).



Whenever a signal reaches the receiver that is strong enough to open the squelch, "**BUSY**" will be displayed.

Bargraph segments appear in the **S&PO** box below the frequency on the display while receiving, indicating received signal strength. This indication is not af-

ected by the squelch setting, so even squelched signals give some indication. If you notice more than one or two bargraph segments appear while the squelch is closed, try reducing the **SQL** control setting (if you want to hear weak signals).

Tuning

To tune your operating frequency, the transceiver must be in what we call the Dial mode (see box below). If no memory number is present in the shaded box in the upper left-hand corner of the display, the Dial mode is selected. Otherwise, press the **D/MR** button to change to the Dial mode.

To select the MHz range for operation, press the **MHz** button (if nothing happens, see the **LOCK** description on page 5). Digits to the right of the 1-MHz digit are cleared from the display for five seconds, during which you can use the selector knob or the microphone **UP/DWN** keys to change the MHz range. Try it, and note the beeps when using the microphone keys: () when moving up, and () when moving down. When done, press **MHz** again, or just wait five seconds.

You can use the selector knob or the microphone keys to select your operating frequency. However, if you press and hold the **UP** or **DWN** key for more than 1/2-second scanning will start. This is described later, so for now, just press the microphone key again to stop (if you have to).

Tuning Step Size

Tuning steps are factory preset to 25 kHz. To change to another step size (10, 12.5 or 20 kHz) press **F + STEP** and use the selector knob or microphone keys to select a different step (the step size is displayed at the right). The small “**5**” or “**P**” at the left is the scan mode indicator, described later. When the desired step size is displayed, press **REV** (the same button) to return to the normal display.

“Dial” and “Memory” Modes

The FT-912R has two different operating states, referred to as the “Dial mode” and the “Memory mode”, which affect the functions of most of the controls. It is important to know which state is currently active when changing frequencies. To determine which state is active, look at the upper left corner of the display. When the Memory mode is active, a Memory number appears. To switch operating states, press the **D/MR** key.

Disabling The Beeper

You can toggle the musical beeper on and off by pressing **F + BEEP**. While learning the features, we recommend you keep it on, as the musical beeps help as you familiarize yourself with the controls.

Transmitting

Press the **LOW** button to select low power output (L). When you wish to transmit, wait until the channel is clear (“**BUSY**” not displayed), and squeeze the PTT switch on the microphone. During transmission “**ON AIR**” is displayed in reverse letters to the left of the **S&PO** box, and the bargraph shows relative transmitter power output. Release the PTT switch to receive.

If more power is required, press the **LOW** button again (L). However, we recommend using low power whenever communication is possible with it, to minimize possible interference to other stations.

If using a version B (in Europe), press the **BURST** button on the MH14A8 microphone, to transmit a 1750-Hz Burst Tone to access repeaters that require it.

Repeater Splits

The FT-912R offers two methods of handling repeater shifts: either by a programmable “standard” shift which can be applied to any receive frequency just by pressing the **RPT** button, or by storing independent transmit and receive frequencies in memory channels (described on page 15). For the standard shift, European versions are supplied preprogrammed for 35-MHz shift (this can be changed as described in the box below). However, for other versions, no repeater shift is originally stored, so this *must* be set first, as described in the box below.

As just mentioned, pressing **RPT** activates repeater shift: once for minus shift, or twice for plus shift (“-” or “+” displayed above the 10-kHz frequency digit).

Selecting a Standard Repeater Offset

Press **F + RPT** to display the currently stored offset, and then press the **MHz** button and use the tuning knob to change it to the desired offset. Finally, press the **RPT** button again to return to the operating frequency display.

When you press the PTT switch to transmit (or the **REV** button to reverse transmit and receive frequencies), the display will shift down or up by the programmed offset, if in band (or else “*Err*” is displayed). Pressing **RPT** again returns you to simplex operation.

Memory Storage

The FT-912R offers 18 general purpose memories, numbered 1 through 18, and three special memories, labelled C, L and U. The general purpose memories and the “C” (Call Channel memory, see box below) can each store separate receive and transmit frequencies or repeater shift, and tone squelch data (if the optional FTS-12 is installed). The L and U memories can store everything *except* separate transmit frequencies, and are used for PMS operation, described later.

To store a frequency in memory:

- (1) Select the desired frequency (and repeater split, if desired) in the Dial mode as already described.
- (2) Press and hold the **F/WRITE** key for ½-second (until the second beep sounds). A memory number (or letter C, L or U) appears blinking in the shaded box at the upper left corner of the display.
- (3) Within five seconds of the last step (while the memory number is blinking), use the selector knob or microphone keys to select the desired memory for storage. If you select one that was already being used, it will be overwritten with new data in the next step.
- (4) Press **F/WRITE** again to store the displayed data into the selected memory: the memory number will stop blinking for a second, and then disappear as operation continues in the Dial mode.

Call Channel Memory

Memory C is a special ‘Call Channel Memory’, which can be instantly recalled from any mode just by pressing the **CALL** key. To store a frequency in the Call Channel, follow the same steps as for other memories (selecting channel “C”), but press the **CALL** button instead of **F/WRITE** in the last step.

After using the Call Channel, press **D/MR** to return to the last selected mode.

Storing Repeater Frequency Pairs

When storing repeater frequency pairs in memory you have the choice of either the Repeater Split standard offset method, described previously, or of storing separate transmit and receive frequencies. To store a separate transmit frequency, just store the receive frequency as described above, and then tune to the desired transmit frequency, press **F/WRITE** again for ½-second, and then hold the PTT switch while pressing **F/WRITE** once more (the transmitter will not be activated in this case). Both methods give similar results in operation, except that storing a separate transmit frequency applies only to one memory, while the offset method applies to all (when the **RPT** button is pressed).

Memory Recall

To recall stored memories press **D/MR** to select the Memory mode (a memory number is displayed), and then rotate the selector knob or press the microphone keys to select the desired memory. Only prestored memories are displayed: empty memories are skipped.

If you stored a memory for split-frequency operation by the standard offset method, “-” or “+” will be displayed to remind you of the shift. If you stored a memory with a separate transmit frequency, “- +” are displayed together to remind you of this. In either case, you can press the **REV** button to check the transmit frequency without actually transmitting (and press it again to return).

You can also retune a memory once it is recalled, by pressing the **MHz** button: “**M TUNE**” appears at the bottom center of the display, and you can tune the displayed memory frequency in the same ways as described before (including the “MHz” tuning). If you retune and want to store the new memory settings (in the current, or another memory), just follow steps (2) – (4) of the memory storage procedure above: operation will be left on the memory.

If you don't want to save your changes to the memory, just press **D/MR**: once to return to the original memory data, and again to leave the memories and return to the Dial mode.

Hiding and Erasing Memories

As already mentioned, storing data in a memory automatically overwrites data that was previously stored there. However, if you regularly move from one town to another, you may not want to use the same number of memories all the time,

or you may wish to change your operating memories without having to rewrite them from scratch. This can be done by masking certain memories so that they are completely hidden from operation until you want to unhide them for use.

To completely mask a memory, recall it and press **F/WRITE** for ½-second (until the memory number blinks). Then press the **REV/STEP** button. This causes the display to change to memory 1, and the previously-selected memory is no longer selectable manually, or by scanning (as described later).

To unmask a hidden memory for operation, recall any memory and press **F/WRITE** for ½-second. Then select the memory number to be restored, and press the **REV/STEP** button.

When storing new memories while some are hidden, avoid accidentally over-writing the ones you've hidden!

Scanning

Before starting the scanner, make sure the **SQL** control is set to silence the noise on a clear channel. Scanning is activated and deactivated by the **UP** or **DWN** key on the microphone. Just press and hold the key for ½-second to start the scanner. If the transceiver is in the Dial mode, band scanning will result. If a memory number is displayed, the transceiver is in the Memory mode, and only the memories will be scanned.

The scanner pauses (and the decimal point on the display blinks) whenever a signal is detected which is strong enough to open the squelch, and scanning will automatically resume after the carrier drops or a 5-second pause (see box below).

Scan/Priority Resume Modes

You have a choice of two scan-resume modes: either *Pause* mode, in which the scanner pauses for as long as the carrier keeps the squelch open, or the 5-second duration mode, in which the scanner pauses for five seconds and then resumes scanning whether or not the signal is still present.

To set the scan-resume mode, press **F + STEP**. A small "*P*" or "*5*" at the left indicates the current mode. Press **F/WRITE** to change it, or just press the **REV/STEP** button alone to return to the frequency display.

You can stop the scanner manually by pressing the PTT switch, **UP** or **DOWN** key on the microphone, or the **D/MR** button.

Memory Skip Scanning

When you have some busy channels stored in memories you may wish to skip them when scanning other memories, but still have them available for manual selection. You can mark a memory to be skipped by pressing **F + SKIP** while the memory is recalled. "**SKIP**" will be displayed just to the right of the memory number box, and this memory will be skipped during scanning (although you can still recall it manually).

To unmask a scan-skip memory, just repeat the same steps you took to mask it: select the memory manually, and press **F + SKIP**.

Programmable Memory Scanning (PMS)

In addition to band and memory scanning, the FT-912R can scan between two frequencies of your choice stored in the special memories labelled "**L**" and "**U**":

- (1) Store the lower edge of the desired scanning range in memory L, and the upper edge (or the next highest 100-kHz step, if not a multiple of 100 kHz) in memory U.
- (2) With either memory U or L recalled, press the **MHz** button. "**M TUNE**" will appear at the bottom center of the display.

You can now tune or scan with the methods described previously. Operation will be confined to the range between the U and L memories (actually, to the nearest multiple of 100 kHz (xxx.000, xxx.100, xxx.200, etc.) equal to or below the L and U memories – see the example below).

To cancel PMS operation, stop scanning, if necessary (with the microphone keys or **D/MR**), and press **D/MR**: once to return to regular memory operation, or twice to return to Dial mode.

PMS Example: Say you want to scan each 25-kHz step between 1242.875 and 1243.075 MHz. Proceed as follows:

- First store 1242.875 MHz in memory L –

In the Dial Mode, tune to 1242.875 MHz, hold **F/WRITE** for ½-second, select memory L, and press **F/WRITE** again.

- Now store the high edge in memory U (note that this is **NOT** the same as the highest frequency of interest!) –
Still in the Dial Mode, tune to 1243.100, which is the *next highest* 100-kHz step from the highest frequency you want to check, and again hold **F/WRITE** for ½-second, select memory U, and press **F/WRITE** again.
- Finally, press **D/MR** to recall the memories (confirm that either memory L or U is selected), and press **MHz** followed by the microphone **UP** or **DWN** key.

Priority Channel Monitoring

The Priority function allows automatic checking for activity on a memory every five seconds while operating in either Dial or Memory modes. When a signal appears on the priority memory while receiving, operation will automatically shift to that memory, for five seconds or as long as a carrier is received (see box on page 16). If you transmit while paused on the priority memory, priority monitoring is cancelled and operation stays on the priority memory.

The squelch must first be preset, and the frequency to be monitored must be stored in a memory (this *must* be memory 1 if you will be operating on other memories during priority monitoring).

Press **D/MR** to select either the Dial or Memory mode you want to operate on, and then press **F + PRI**. A “**P**” will appear in the memory window at the upper left corner of the display, and about every five seconds the displayed frequency will shift to the priority memory briefly while the receiver checks for a signal.

As long as no signal appears on the priority memory to open the squelch, you can tune, transmit and receive on the Dial, or select and operate on other memories. If a station you wish to talk with appears on the priority memory, press the PTT switch momentarily while receiving his signal, to stop priority checking. Otherwise, when a signal appears on the priority memory the scanner will pause and the decimal on the display will blink; then priority monitoring will resume. To cancel priority monitoring manually, press **D/MR**.

Note that you can use any other memory as a priority channel in the above procedure when operation during priority monitoring will be in the Dial mode.

Tone Squelch Operation

The FT-912R includes a CTCSS (Continuous Tone-Coded Squelch System) encoder (for transmitting), and can also be used to silently monitor for calls on busy channels when the optional FTS-12 Tone Squelch Unit (decoder) is installed. The encode function superimposes a subaudible tone (at a frequency too low to be heard) on the transmitted carrier, while the decode function (of the FTS-12) monitors receiver audio through a narrow filter at the same subaudible frequency, keeping the squelch closed until a matching tone is received. Installation instructions for the FTS-12 are on page 33.

To check or set the CTCSS tone frequency, press **F + TONE**. The tone frequency will be displayed (in Hz), with a leading zero if that tone selection is a high-Q type. To change the tone frequency, rotate the selector knob or press the microphone **DWN/UP** keys until the display shows the tone frequency you require (the display will step through the standard EIA tones, plus 97.4 Hz - see the lower table on page 30). Press **TONE** to return to the operating frequency display when the tone frequency is selected.

To activate tone squelch press **TONE**. "**ENC**" (encode) will be displayed and the tone generator will be activated for transmission. Press **TONE** again and both "**ENC**" and "**DEC**" (decode) will be displayed together as tone squelch is activated for both transmission and reception (only if the FTS-12 is installed: a matching tone frequency will open the squelch). Pressing **TONE** once more disables tone squelch features.

Once you have the tone squelch set up the way you want it, you can store it in any memory. Afterwards, to change a memory, just recall it, reset the tone frequency or function, and store the memory again (press and hold **F/WRITE** ½-second, and then press it again momentarily).

DVS-1 Digital Voice System (Option)

General Description – Technical Information

The DVS-1 is a combination of the latest microprocessor-controlled PCM (pulse-code modulation) digital voice recording and memory circuitry and digital DTMF decoder, which can record from the microphone or receiver, and playback through the transmitter or loudspeaker. Installation is described on page 32.

One megabit of RAM (random access memory) in the DVS-1 can serve as a single block for up to 128 seconds of recording, or divided into four or eight shorter segments for selective recording and playback. Without the operator being present, incoming messages can be recorded by remote DTMF-equipped stations having access to the private station ID number, and these messages can then be read back by the station operator, either locally or also by remote access through DTMF control codes.

The sampling bit rate of the A-D (analog-to-digital) converter is front panel selectable between 8, 11, 16 and 32 kilobits/second, allowing the operator to select the optimum trade-off between recording time and fidelity. Different bit rates may be selected for different segments.

The programmable private station ID number (0001 to 9999) can be activated to restrict recording and playback, or recording only, of selected messages to only those stations who know the ID number you programmed.

The S-meter serves as an “elapsed time” indicator during recording and playback, and the microphone **DWN** and **UP** keys serve to activate and deactivate recording and playback.

Voice System Display

The DVS-1 is toggled on and off by the **VOICE** button. The transceiver display when the DVS-1 is on is shown below, followed by descriptions of each item:

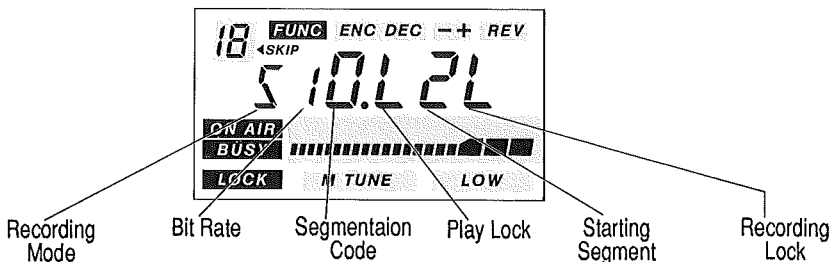

Recording Mode (“s” or “M”)

This leftmost character indicates the currently selected source of audio for recording: either “S” for Speaker (that is, the receiver loudspeaker), or “M” for Microphone. The **TONE** button toggles between these recording modes while the DVS-1 is active. Note that each Segmentation Code (described below) has its own setting.

Bit Rate (“1” – “4”)

The number displayed in this location signifies the selected sampling bit rate for recording or playback in this Segmentation Code, as follows:

Displayed #	Bit Rate (kb/sec)	Recording Time per Segment	Total Recording Time (all Segs)
1	32	4 seconds	32 seconds
2	16	8 seconds	64 seconds
3	11	12 seconds	92 seconds
4	8	16 seconds	128 seconds

Note that the slower bit rates (larger Displayed Nos.) provide more recording time, but at reduced fidelity. While the DVS-1 is activated, pressing the **REV** button and rotating the tuning knob (while the displayed Bit Rate is blinking) allows selection of the different rates.

Segmentation Code (“0” – “9” or “A” – “F”)

The character displayed here indicates both the segmentation method and which segment(s) is selected of the 8-segment digital memory, for recording and playback, as follows:

- 0** Segments 2 through 8 combined
- 1** Segment 1 (Callsign) only
- 2 – 8** Individual Segment access
- 9** Segments 1 and 2 combined
- A** Segments 3 and 4 combined
- b** Segments 5 and 6 combined
- C** Segments 7 and 8 combined
- d** Segments 2 and 4 combined
- E** Segments 5 and 8 combined
- F** Segments 2 - 8 accessed sequentially (one at a time)

While the DVS-1 is activated the tuning knob selects the Segmentation Code.

Play Lock ("L" or blank)

"L" is displayed here when the Segmentation Code has been Locked to prohibit remote playback. These codes may still be played back locally, but cannot be recorded over or played back remotely. While the DVS-1 is activated, press the MHz button to toggle among Record Lock, no Lock, and both Playback and Record Lock (there is no Playback Lock only).

Starting Segment ("1" - "8")

The number here is the starting Segment number of this Segmentation Code for recording or playback. This is, of course, identical to the Segmentation Code for Codes 1 - 8, and is automatically selected when the Segmentation Code is chosen by the tuning knob.

Recording Lock ("L" or blank)

"L" is displayed here when the displayed Segmentation Code has been Locked to prohibit recording (*both* local and remote). The description of Play Lock above describes how to select the Lock status. The record lock status can be changed remotely.

Segmentation Code Selection Notes

While the DVS-1 is activated, the tuning knob selects from among the sixteen possible Segmentation Codes. As indicated above, each Segmentation Code has its own set of associated parameters, displayed when each Code is selected.

Segmentation Code 1 is a special-purpose segment which should be recorded with your callsign. It is played back automatically in front of any of the other Codes when the DVS-1 is called remotely, to identify your station.

Note that Segmentation Codes 0, 9 and A - F select the same memory segments as Codes 1 - 8, merely with different partitioning (grouping of the segments). Therefore, if you record in Code 2, for example, the recording will be played back in Codes 0, 2, 9, d and F, since all of these access segment 2.

Recording

You will probably want to partition the memory for two different purposes: storing your own automatic replies to incoming calls, and recording incoming messages. You should therefore determine how much of the memory to dedicate

to each purpose , which will in turn determine which memory segments to use for each purpose. However, regardless of that consideration, you should record your callsign in Segment 1, since this will be played back automatically in front of other DVS-1 responses to incoming calls.

Recording is turned on (and can be manually turned off) by the **UP** button on the microphone. While recording, the S-meter indicates the relative recording time elapsed: when the S-meter reaches full scale, the memory being recorded is full.

To record your callsign:

- Turn on the radio, and press **VOICE** to activate the DVS-1.
- Press the **TONE** button, if necessary, so that “**M**” is displayed at the left (to select Microphone recording).
- Note the bit rate number displayed just to the right of the “**M**” . You will want to experiment with all four possible bit rates (as detailed below), but for now, let’s start with the fastest rate, number 1. If another number is displayed, press the **REV** button, turn to tuning knob until “**1**” is displayed next to the “**M**” , and press **REV** again.
- Rotate the tuning knob to select Segmentation Code 1 in the center of the display. Notice that a “**1**” also appears in the Starting Segment display position (Code 1 always starts with Segment 1).
- There should not be any “**L**”s on the display, since you don’t want to lock out your callsign (everybody should receive it). If you see an “**L**” at the right, press the **MHz** button, repeatedly if necessary, to clear all “**L**”s.
- Keep your finger near the **UP** button on the microphone as you hold it near your mouth. Now while watching the S-meter for elapsed recording time, press the **UP** button and speak your callsign, then either press **UP** again to stop recording, or just wait until the S-meter reaches full scale (recording stops automatically).

Unless you have a very short callsign, or spoke quickly, you probably didn’t have time to fit it all in between the two beeps that signalled the start of recording and the beep at the end. Anyway, to check your results, just press the **DWN** button on the microphone (and adjust the volume, if necessary).

If you were very close, you might want to just press the **UP** button again and re-record, speaking a little faster. Otherwise (or just for fun), change the bit rate to 2 (press **REV**, turn the tuning knob one click clockwise, and press **REV** again) and try again. Notice you have twice the recording time (the S-meter advances more slowly during recording).

Press the **DWN** button again to play back this recording. You may notice it sounds a little 'scratchy'. Bit rates 3 and 4 provide even longer recording times, but sound even more scratchy (go ahead and try them). If you find you have a lot of left-over time (as indicated on the S-meter), press any microphone button to stop recording. Pick the fastest bit rate that gives you just the necessary recording time.

You can record any other memory segments in the same way you did your callsign. You may even record while transmitting (if the DVS-1 is activated), in which case Microphone recording is automatically selected.

On-The-Air Recording & Playback

When the DVS-1 is on, you can play back over the air anything that you have previously recorded: select the Code to play back and then press the **DWN** button while holding the PTT switch.

You can also record incoming signals heard in the loudspeaker:

- Press **VOICE** (if displaying frequency) to activate the DVS-1.
- Press **TONE**, if necessary, to select the Speaker recording mode.
- Select the desired Segmentation Code using the tuning knob, and then select a Bit Rate using the **REV** button and tuning knob.
- Press the **UP** button on the microphone to start recording.
- Press the **DWN** button to play back the recording (and hold the PTT if you want to play it back over the air).

Remote Recording & Playback

If you have a second transceiver (any type, but with a DTMF keypad), you can operate the DVS-1 remotely using 3-key DTMF commands. To do this, the DVS-1 must first be activated and then set to the Remote Control Mode, as follows:

- Press **VOICE** (if displaying frequency) to activate the DVS-1.
- Note the indicated Bit Rate, and change it, if desired, by pressing **REV**, turning the tuning knob to select the desired Bit Rate, and pressing **REV** again.
- Press the **RPT** button (the display will show simply "**R**" followed by the Bit Rate number "**1**" – "**4**").

The transceiver is now set for remote control. The chart below shows the various commands and their results. To send a command, hold the PTT switch on the remote transceiver while pressing the indicated DTMF keys, one at a time. Then, if you are recording, speak into the microphone. Otherwise, release the PTT switch and listen for the response from the DVS-1. Note that Segment 1 (which should be your callsign) is read back before any other data is transmitted.

DTMF Remote Commands

Command	Keys	Description	Note
Reset	# # #	Cancel import or stop recording	—
Check Empty	# 0 0	Check for unused segment(s)	1
Record All	* 0 0	Record segments 2 through 8	2
Record One	* 0 1	Record in any (unlocked) segment	3
Bit Rate	* 1 <i>r</i>	Set Bit Rate <i>r</i> (1 – 4) for recording	2
Confirm	# 0 1	Play back (confirm) last recording	4
Lock Last	* 0 2	Lock last recording	1
Playh All	# 1 0	Play back all unlocked segments	4
Play One	# 1 <i>x</i>	Play back segment <i>x</i> (1 – 8 only)	4
Unlock All	# 2 0	Unlock all locked segments	1
Unlock One	# 2 <i>x</i>	Unlock segment <i>x</i> (1 – 8 only)	1

Notes to the Table:

- (1) High/low tone response indicates success (memory available or lock/unlock executed), else low/high tone response indicates failure (memory full or lock/unlock not executed).
- (2) Callsign played back followed by a single beep if record successful, else low/high tones returned after callsign playback (to indicate record attempt failed).
- (3) Same as Note (2) if command accepted, else no response.
- (4) Callsign played back followed by a single beep and then the selected segment(s), if successful. Low/high tones if playback command rejected. In the case of multiple segments, each is separated by (suppressed) high/low beeps.

Note on Testing the DVS-1 Remote Control

If the remote transceiver is very close to the DVS-1, the DVS-1 may be overloaded by the transceiver's rf field when transmitting, which may cause the DVS-1 to shut down (and return the display to the operating frequency) after responding to a remote command.

Whenever a remote command is received, the transceiver display shows the Segmentation Code accessed (0, or 2.- 8). Up to four Codes will be displayed, scrolling in from the right on a first-in/first-out basis (older Codes disappear). This allows you to tell at a glance if someone has called, and in which segments their messages may be located.

Locking Segments

During non-remote operation, you may record some segments that you don't want played back over the air during remote access. These can be locked out locally by pressing the **MHz** button when the DVS-1 is in its normal (non-remote) mode. Pressing **MHz** once locks out both recording and playback, indicated by an "L" near the center of the display and another "L" at the right side of the display.

Caution!

Allowing the FT-912R to transmit unattended may not be legal in your country. Please check with your dealer before using it for remote operation. If not legal, you can disable the automatic transmission feature by bridging the split pad indicated in the diagram below. Note that automatic recording during remote operation is not inhibited by this modification.

Bridge this split pad with solder

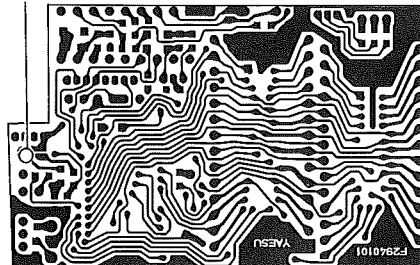

DVS-1 Solder Side

Press **MHz** a second time to allow playback, but not recording (only the rightmost “**L**” displayed). Press **MHz** a third time to re-enable both recording and playback.

Note that segments that are locked out for playback cannot be accessed by remote operators. However, segments locked out for recording only (only rightmost “**L**” displayed when the Segmentation Code is displayed), can be unlocked by remote operators, and then recorded over and locked again, if desired. The usefulness of this design is that if you are away from the transceiver and have set it for remote operation, your friends can call in and leave messages. You can then access these messages while you are away, using another transceiver, and either leave your replies or just clear the available memories (those you haven’t locked out for playback locally) to accept new messages.

Private Station ID Code

Obviously, the remote recording system just described could be a prankster’s delight, so a special private station ID code is also programmable in the DVS-1 to prevent anyone from accessing the memories who does not know your ID code. Your ID code may be any number from 0001 to 9999. Once you have selected your ID, be careful who you divulge it to.

To set your ID code:

- From the frequency display, press **VOICE** to activate the DVS-1, and then press **F/WRITE** followed by the **RPT** button. The display now shows the current ID code (or “**0000**” if none is stored), with the rightmost digit blinking.
- Rotate the tuning knob to change the blinking digit.
- Press the **DWN** button on the microphone to shift the blinking digit one place to the left.
- Repeat the last two steps until the display shows the desired ID code number. Then press the **RPT** button again to return to the original DVS-1 display.

Once you have programmed your ID code, any station calling in with a remote command (when the DVS-1 is set for remote operation) must precede his DTMF command with the ID code you just stored. Leading zeros are not required, so, for example, if your ID code is 0001, remote DTMF commands will be accepted when prefixed only by a 1.

Any remote commands received without the ID code prefix will be ignored (unless you set the ID code to 0000).

CAT System External Computer Control

The CAT (Computer Aided Transceiver) System in the FT-912R allows external control of the operating frequency, transmit/receive switching, high/low transmit power selection and CTCSS tone frequency and encode/decode status from an external personal computer (CTCSS decoding requires that the optional FTS-12 CTCSS Unit be installed).

Interconnections

For CAT control, the microphone jack on the transceiver should be connected via the FIF-232C CAT Interface Box to the RS-232C serial port of your personal computer. The FIF-232C is available from your Yaesu dealer. Use shielded cable for the microphone jack-to-Interface Box connection, and keep it as short as possible to avoid problems from RF pickup. Serial data is passed from pin 2 or pin 3 (Tx/D) of the computer serial port to pins 1 and 3 of the microphone jack on the front panel of the transceiver, wired as shown here:

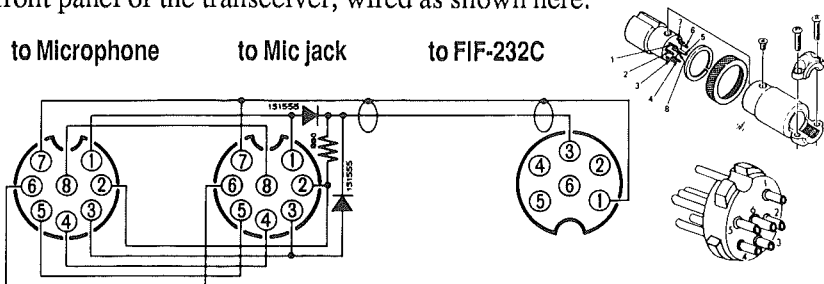

Data Format

Data is sent at 4800 bits/sec., and each data byte sent consists of one start bit, 8 data bits, two stop bits and no parity bit:



One byte, sent left-to-right

All CAT System data transfers consist of blocks of five bytes as just described, sent with 50 to 200 ms between each byte. The last byte to be sent in each block is the instruction opcode, while the first four bytes of each block are arguments:

either parameters for that instruction, or dummy values (required to pad the block out to five bytes when fewer are needed by the instruction):

4th Arg Byte	3rd Arg Byte	2nd Arg Byte	1st Arg Byte	Opcode
--------------	--------------	--------------	--------------	--------

5-byte Command Block, sent left-to-right

Programming

There are five types of instruction opcodes for the FT-912R, listed in the Instruction Code Chart on the next page. Notice that only two of the instructions require arguments. However, every Command Block sent to the transceiver *must* always consist of five bytes. The unused parameter bytes will be ignored when such Instructions are executed, so the value of the unused parameter bytes is irrelevant (they need not be zeroed).

EXAMPLE: Set the current operating frequency to 1245.5000 MHz;

- First determine the opcode for the desired instruction (see the CAT Commands Table). These opcodes should be stored in the user's control program, so they can be looked up when the user requests the corresponding command from the keyboard. In this case the instruction is "Frequency Set", so the opcode is 01h (the small "h" following each byte value indicates a hexadecimal [base 16] value).
- Build the four argument byte values from the desired frequency by breaking it into 2-digit blocks (BCD "packed decimal" format). Note that all frequencies in the FT-912R are in the 1200-MHz range, so the hundreds-of-MHz digit used in all Frequency Set commands is the hex digit "C" (equal to 12 decimal).

The resulting 5-byte block should look like this (in hexadecimal format):

Byte Value	C4h	55h	00h	00h	01h
Content of this byte	1200 MHz & 10's of MHz	1's of MHz & 100's of kHz	10's & 1's of kHz	100's & 10's of Hz	Freq. Set opcode

- Send these five bytes to the transceiver, in left-to-right order as shown in the table above. In Basic, this could be done with the following line:

```
PRINT #2, CHR$(&HC4); CHR$(&H55); CHR$(0); CHR$(0); CHR$(1);
```

CAT Commands

Command Name	Parameters				Op-code	Notes
CAT On/Off	—	—	—	—	<i>nn</i>	<i>nn</i> = 00 to turn on, 80h to turn off. Must be turned on before any other command is sent.
Frequency Set	<i>f₁</i>	<i>f₂</i>	<i>f₃</i>	<i>f₄</i>	01h	<i>f₁</i> – <i>f₄</i> are BCD frequency - see example in text
Tx/Rx	—	—	—	—	<i>tt</i>	<i>tt</i> = 08h to transmit, 88h to receive
Hi/Low Power	—	—	—	—	<i>pp</i>	<i>pp</i> = 78h for low, F8h for hi pwr
CTCSS Status	—	—	—	—	<i>ss</i>	<i>ss</i> = 0Ah for Enc+Dec, 4Ah for Enc-only, or 8Ah for Off
CTCSS Tone Code	<i>cc</i>	—	—	—	FAh	<i>cc</i> = subaudible tone frequency code from CTCSS table (below)

CTCSS Tone Frequency Codes

Frequencies are in Hz as displayed on the radio, Codes are hex ✕

Freq. Code	Freq. Code	Freq. Code	Freq. Code
67.0 3Eh	118.8 33h	173.8 28h	The selections below are Hi-Q (Q = 80)
71.9 3Dh	123.0 32h	179.9 27h	
77.0 3Ch	127.3 31h	186.2 26h	067.0 1Dh
82.5 3Bh	131.8 30h	192.8 25h	071.9 1Ch
88.5 3Ah	136.5 2Fh	203.5 24h	074.4 1Bh
94.8 39h	141.3 2Eh	210.7 23h	077.0 1Ah
100.0 38h	146.2 2Dh	218.1 22h	079.7 19h
103.5 37h	151.4 2Ch	225.7 21h	082.5 18h
107.2 36h	156.7 2Bh	233.6 20h	085.4 17h
110.9 35h	162.2 2Ah	241.8 1Fh	088.5 16h
114.8 34h	167.9 29h	250.3 1Eh	091.5 15h

In Case of Problems

FT-912R operation is not complicated, but it is still possible to get lost, at least until you have had the chance to learn the various functions of the keypad and display. If the display shows nothing at all, check the power switch, and the power supply connections.

Fortunately, the display includes enough symbols and function indicators to let you know what is going on as long as power is applied, so it is well worthwhile to study the display diagram on page 6 carefully. For example, if the frequency display changes unexpectedly when you transmit (or if “**Err**” appears), check for a small “+” or “-” near the upper right. Also, if only a few seemingly non-sensical digits appear, try pressing **TONE** to disable the tone squelch setting feature. If nothing happens, try pressing **VOICE** to disable the DVS-1 Digital Voice System (if it is installed).

If pressing a key appears to do nothing, first check for “**LOCK**” at the lower left, which indicates if the buttons are locked. If so, press **F + LOCK** to unlock the keys. Otherwise, if “**LOCK**” is not displayed, press **D/MR**, which will terminate any partially entered commands. If you still cannot enter data, check to see if “**ON AIR**” is displayed, indicating that the transceiver is transmitting. Releasing the PTT switch should return the set to receive. If still nothing happens, switch the transceiver off, and then back on.

To avoid confusion resulting from inadvertent key presses, set the keypad lock on (press **F + LOCK**) if you leave the transceiver unattended while it is on, and then remember to set the lock back off when you wish to enter data.

DVS-1 Digital Voice System Installation

The DVS-1 is a digital voice recording and playback system which allows you to record either through the microphone or the receiver, and to play back selected recorded messages through the speaker or transmitter. Remote-controlled recording and playback is also provided by a built-in DTMF decoder. See page 20 for operational details.

- ❑ Disconnect the power cable at the rear of the transceiver, place the transceiver upside-down on the workbench, and remove the four screws on the bottom cover. Loosen the two screws on each side, and remove the bottom cover.

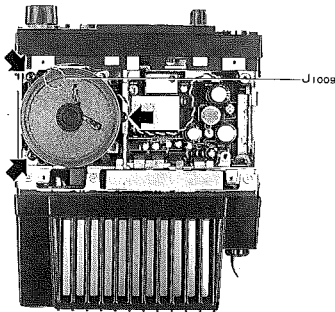
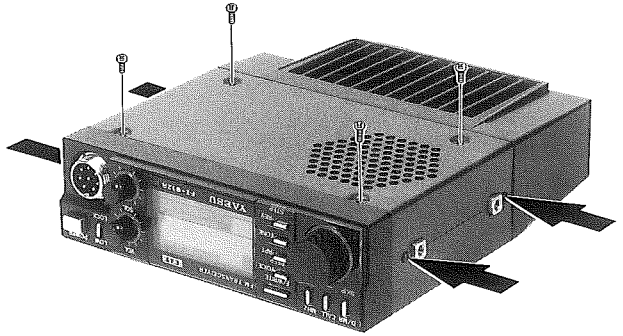

- ❑ Lift the loudspeaker out of its holder, remove the three screws in the arms of the holder (see left), and lift it from the chassis.
- ❑ Connect the 8-pin plug from the DVS-1 to 8-pin jack J2003 on the inside of the front panel (the gray wire should be nearest the center). See below.

- ❑ Connect the 7-pin plug from the DVS-1 to 7-pin jack J2004 on the inside of the front panel (the brown wire should be nearest the center).
- ❑ Connect the 3-pin plug from the DVS-1 to jack J1009 in the right front corner of the speaker compartment.

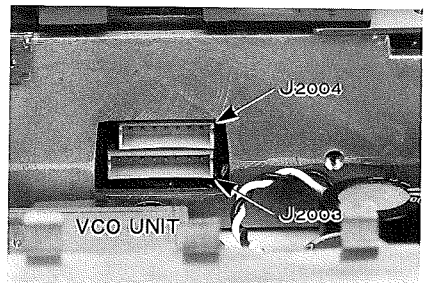

- Making sure that no wires are pinched, set the DVS-1 in place, routing the speaker wires out under the back of the DVS-1. Install the two supplied screws through the tabs in the DVS-1: one in the left front corner of the chassis, and one in the rear.
- Set the Voice Memory Backup Switch in the left rear corner of the DVS-1 (see right) to the ON position (toward the rear).
- If also installing the FTS-12, skip the first step of the FTS-12 Installation. Otherwise, replace the speaker holder and its three screws, and replace the speaker in the holder. Then replace the bottom cover and its four screws, and retighten the two screws on each side.

DVS-1
Backup Switch

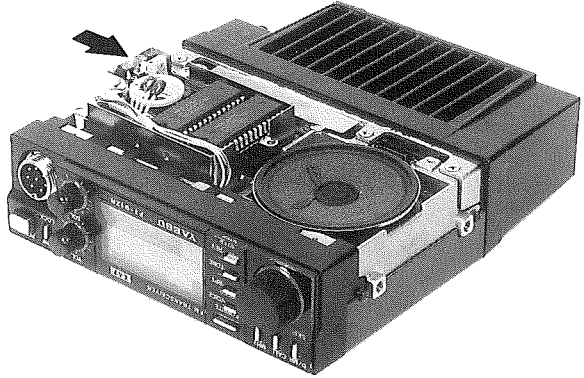

FTS-12 Tone Squelch Unit Installation

The FTS-12 includes a decoder for 37 EIA standard subaudible CTCSS tones, programmable from the front panel of the FT-912R. Silent monitoring of busy channels is provided when the FTS-12 is combined with the built-in CTCSS encoder functions and activated by the ENCode/DECode Tone Squelch function. The FTS-12 is available from your Yaesu dealer. See page 19 for functional details.

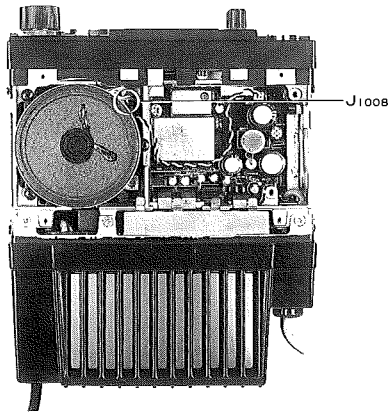

- Perform the first two steps of the DVS-1 Installation on page 32.
- Remove the jumper plug from jack J1008 in the front left corner of the speaker compartment (see above).
- Referring to the photo at the left below, locate the unconnected brown 10-pin connector at the front of the speaker compartment. Align the small tab on one side of this connector with the hole in one side of the jack on the FTS-12, and mate these connectors.
- Press the FTS-12 into the clip on the speaker holder (below right). The output tone level (trimmer potentiometer VR1 on the FTS-12) is adjusted at the factory for the proper deviation, so no adjustment is needed.
- Replace the speaker holder and its three screws, and replace the speaker in the holder. Then replace the bottom cover and its four screws, and retighten the two screws on each side.

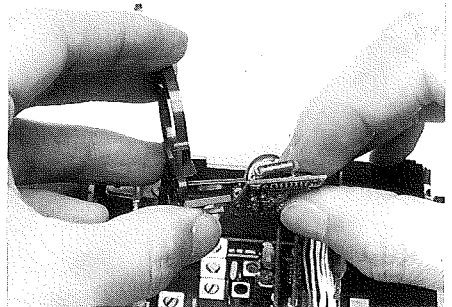
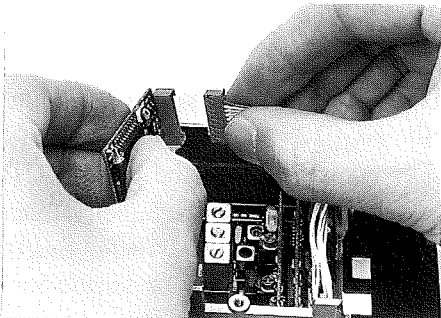

Memory Cloning

All memory data stored in one transceiver can be moved to another by connecting the microphone jacks together as indicated in the diagram below (the cloning cable is *not* available from Yaesu).

- Turn both transceivers off, and then press and hold the **F/WRITE** buttons while turning the power switches on. The displays will be blinking.
- Press the **REV** button on the destination transceiver (the display will stop blinking).
- Press the **RPT** button on the source transceiver. When the data transfer is complete, the displays should return to normal. If "**Err**" is displayed, turn both transceivers off and try again.
- Turn both transceivers off and remove the cloning cable.

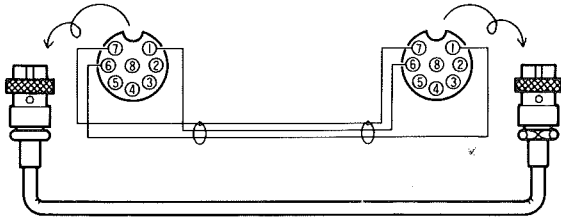
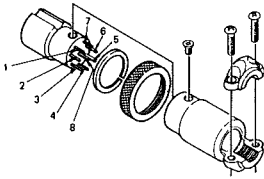

Modification for Packet Radio

As supplied from the factory, pin 5 of the microphone jack is wired through solder bridge jumper number 16 on the Control Unit to allow tone burst activation via the **BURST** button on the MH-14A8 microphone. For packet radio operation jumper 16 must be removed, disabling the **BURST** button, and jumper 15 installed to provide output of the squelch **BUSY** line for packet radio tncs.

- Remove the eight screws affixing the top and bottom covers, and the two screws on each side. Remove the covers.
- Remove the ring nut and lockwasher around the microphone jack, and pull the three knobs from the front panel.
- Without unclipping the plastic cover, grasp the front panel on the top and bottom edges, and carefully slide it forward just enough to expose the corner of the Control Unit pcb nearest the microphone jack.
- Using a fine-tipped soldering iron and solder wick or a solder sucker, remove the solder bridge from **BURST** jumper pad 16, and then add solder to bridge **BUSY** pad 15.
- Press the front panel assembly gently back into place (so that the holes in each side are aligned with those in the chassis). Replace the ring nut and washer over the microphone jack, and the knobs. Replace the top and bottom covers and their eight screws, and the four screws in the sides.

Packet Radio TNC Interconnections

Most popular packet radio tncs can be connected to the microphone jack of the FT-912R as follows:

TNC's RADIO Jack	FT-912R Microphone Jack
Receiver Audio in	pin 4 (8 ohms, de-emphasized)
Squelch Status in	pin 5* (open=8V, closed=0V 1 mA)
PTT (gnd=tx) out	pin 6
Transmit Audio out	pin 8 (400 ohms, pre-emphasized)

*Requires modification as described above.











Use shielded cable for the audio lines, and keep the interconnecting cable as short as possible to avoid RF pickup.





FT-912R OPERATOR'S QUICK REFERENCE CHARTS

CHART 1. KEY FUNCTIONS

	Normal Function	Alternate Func (after )	Digital Voice Func.*
	Toggle Dial/Memory modes	Scan Skip (Memory mode only)	see Normal Function
	Jump to CALL Channel	- none -	see Normal Function
	Toggle MHz Tuning on/off	Toggle PRiority monitoring	Record Lock Select
	Shift other keys to alternate functions	Cancel alternate key functions (automatic after 5 seconds)	F+RPT sets ID code, otherwise no func.
	Toggle DVS-1 Voice Unit	Toggle Beeper	Toggle DVS-1 ON/OFF
	Select Repeater Shift (plus - minus - off)	Display/Set Rptr Offset	Toggle Remote Mode, or set ID code (F+)
	Toggle Tone Squelch** (ENC - ENC/DEC - off)	Display/Set CTCSS Freq.	Toggle Speaker/Mic recording mode
	Reverse Repeater Split (only if RPT active)	Toggle Step Select (and use tuning knob)	Toggle Bit Rate Set (use knob to select)
	Toggle High/Low Power	Lock (or unlock) all keys (exc this one and F/WRITE)	Same as Norm/Alt Funcs

















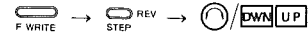

















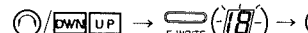

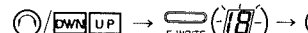

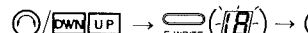

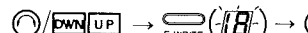







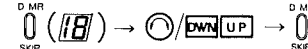





















* Only if DVS-1 installed; otherwise inactive.

** Only if FTS-12 installed; otherwise inactive.

CHART 2. FUNCTIONAL REFERENCE

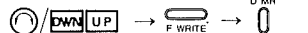
Note: Press , if necessary, to select Dial Mode ("D" in the Chart) or Memory Mode ("M"), before entering other keystrokes. Memory Mode is active when a memory number is displayed in the box at the upper left.

symbols: " / " = or
 " () " = temporary display
 " : " = blinking display
 " + " = press together

Desired Function	Dial/Mem	Keystroke(s)	Display
Beeper On/Off	D/M	 → 	
CALL Ch. Recall	D/M	 	
Channel Step Select	D	 →  → 	 
Hide Memory	M	 → 	
Unhide Memory	M	 →  → 	
Lock/Unlock Knob/Keys	D/M	 → 	
Memory Recall	D	 → 	
Memory Tune	M	 → 	
Memory Storage	D	 →  () →  → 	
Memo Separate Tx Freq.	D	 →  () →  →  +  	
MHz Range	D	 → 	
Priority Monitor (Dial)	D	 () →  →  →  → 	
Priority Monitor (Mem)	D	 → 	
Repeater Standard Split	D/M		
Repeater Split Offset	D	 → 	
Reverse Tx/Rx Freqs.	D/M	 	
Scanning	D/M		
Scan Limited Subband	D	 →  () →  () → 	
Scan Resume Mode	D	 →   → 	
Scan Skip Memory	M	 →  → 	

TONE SQUELCH FUNCTIONS (with FTS-12 option only)

" / " = or

Desired Function	Keystroke(s)	Display
Set CTCSS Tone Freq.	→ → /	888.88
Toggle CTCSS ENC/DEC	/ →	/

DIGITAL VOICE FUNCTIONS (with DVS-1 option only)

Voice System On/Off		5 10 2
Bit Rate Selection	→	5 10 2
Record Mic Input		M 10 2
Record Rx (Speaker)		
Playback in Speaker		
Playback On Air	+	
Remote DTMF Control		R 1
Lock Out Recording and Playback	/ →	5 10 L 2 L
Lock Out Playback	/ →	5 10 2 L

YAESU



YAESU MUSEN CO., LTD.
C.P.O. BOX 1500
TOKYO, JAPAN

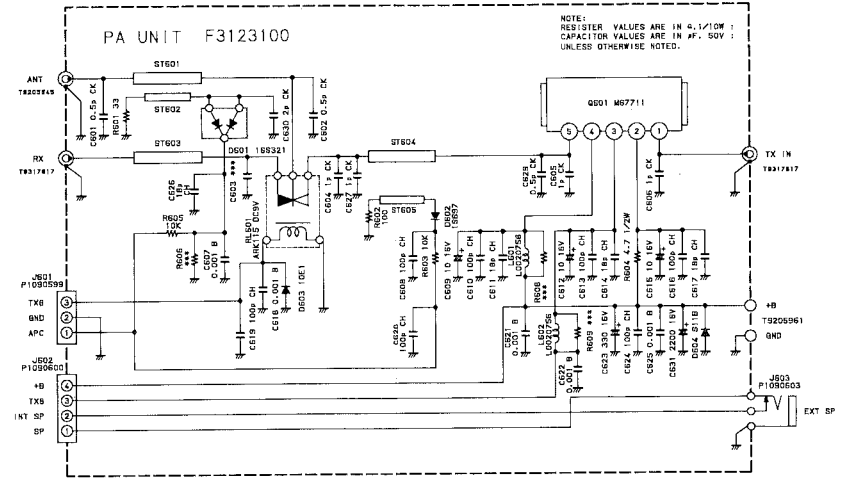
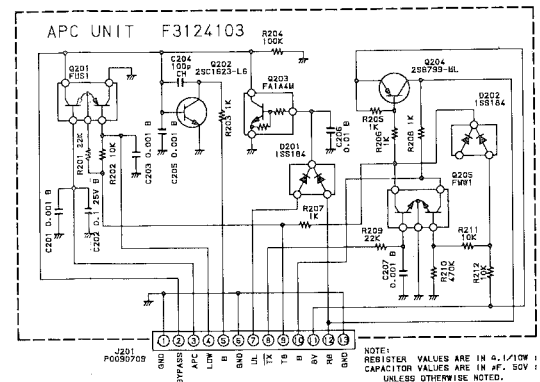
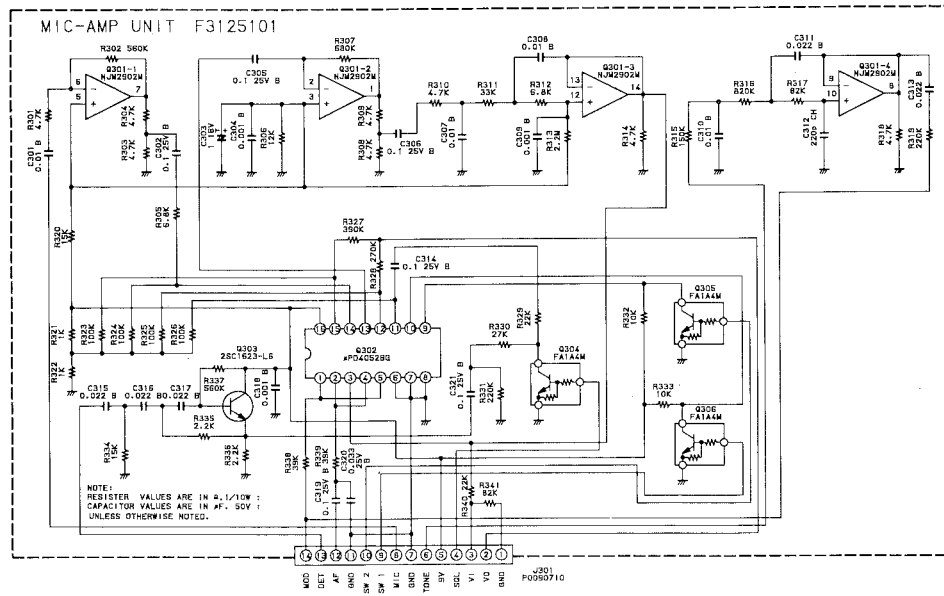
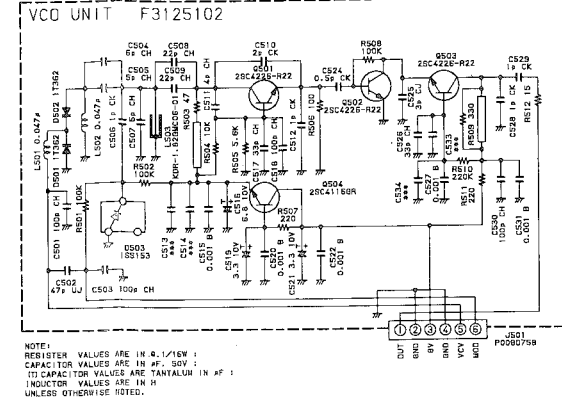
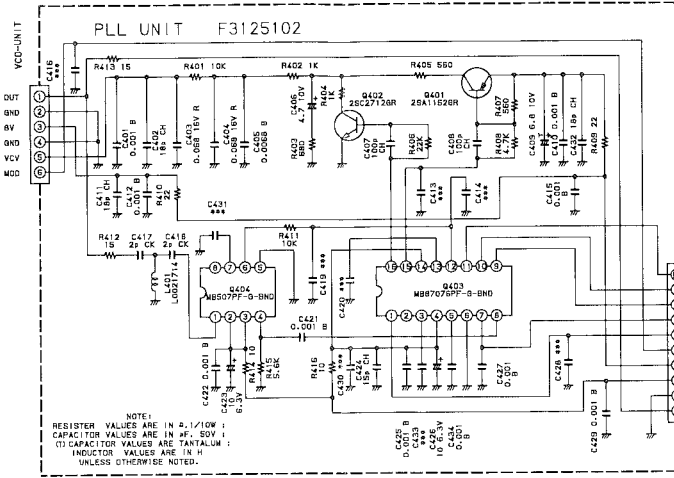
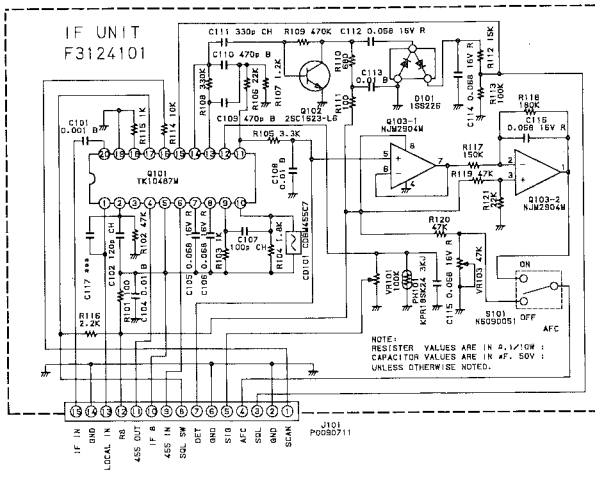

FT-912R Circuit Diagram

MAIN UNIT F3122000

NOTE:
RESISTOR VALUES ARE IN Ω, 1/10W;
CAPACITOR VALUES ARE IN μF, 50V;
CY CAPACITOR VALUES ARE IN μF, 25V;
INDUCTOR VALUES ARE IN H
UNLESS OTHERWISE NOTED.

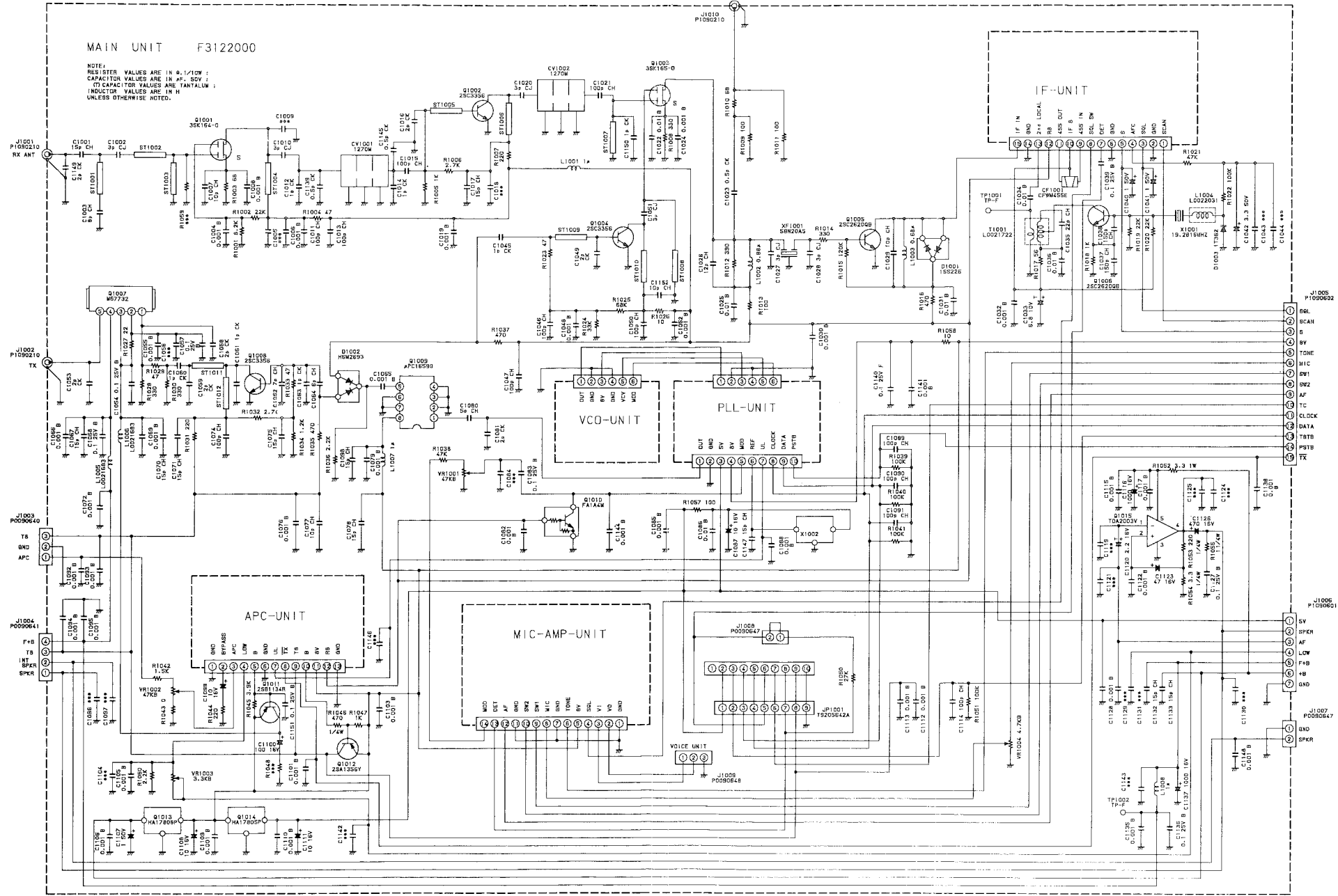

- ① SBL
- ② REAN
- ③ BY
- ④ TONE
- ⑤ MIC
- ⑥ RW
- ⑦ AF
- ⑧ TC
- ⑨ CLOCK
- ⑩ DATA
- ⑪ TRTB
- ⑫ PSTB
- ⑬ TX

- ⑭ SV
- ⑮ SPKR
- ⑯ LW
- ⑰ FB
- ⑱ 4B
- ⑳ GND
- ㉑ GND
- ㉒ SPKR