

# **YAESU**

*Radio for Professionals*

VHF/UHF DUAL BAND FM TRANSCEIVER

# **FTM-150R**

# **FTM-150E**

Advance Manual

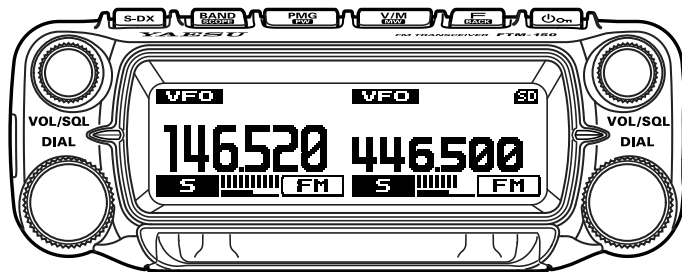

# Contents

<b>Communicating with specified stations</b> .....	<b>5</b>
<b>Selecting the squelch type</b> .....	<b>5</b>
<b>Tone squelch feature</b> .....	<b>6</b>
Setting CTCSS Tone frequency .....	6
Searching for the CTCSS Tone transmitted by the other Station .....	6
<b>Digital Code Squelch (DCS) feature</b> .....	<b>7</b>
Setting the DCS CODE .....	7
Searching for the DCS Code Used by the Other Station .....	7
<b>New Two-Tone CTCSS Pager Function</b> .....	<b>8</b>
Using the Pager Function .....	8
Setting the Code for this Station .....	8
Receiving “Pager Code” calls from a Remote Station (Standby Operation) .....	9
<b>Notification of a Call from a Remote Station by the Bell Function</b> .....	<b>9</b>
<b>Convenient memory function</b> .....	<b>10</b>
<b>Programmable Memory Channel Scan (PMS)</b> .....	<b>10</b>
Registering to the Programmable Memory Channels .....	10
Performing Programmable Memory Channel Scan .....	10
<b>Receiving Weather Broadcast Channels</b> .....	<b>11</b>
Assigning the “WX” function to a programmable key on the microphone .....	11
Recalling the weather channels .....	11
Listening with weather alert .....	11
<b>DTMF Operation</b> .....	<b>12</b>
Registering the DTMF memory .....	12
Setting the auto dialer function .....	12
Transmitting DTMF code automatically using DTMF memory .....	12
Manually Transmitting the DTMF Code .....	12
<b>Copying the Radio Data to another Transceiver</b> .....	<b>13</b>
<b>Connecting an external device</b> .....	<b>14</b>
Connecting to a computer .....	14
Using the transceiver for packet communications .....	15
Updating the transceiver firmware .....	17
<b>Setup Menu</b> .....	<b>18</b>
Setup Menu Operation .....	18
<b>Tables of Setup Menu Operations</b> .....	<b>19</b>
<b>Setup Menu Operations</b> .....	<b>22</b>
<b>DISPLAY</b> .....	<b>22</b>
1 KEYPAD .....	22
2 LCD DIMMER.....	22
3 LCD CONTRAST .....	22
4 BAND SCOPE.....	22
5 S-METER SYMSBOL.....	22
6 BACKLIGHT COLOR.....	23

<b>TX</b> .....	<b>24</b>
7 TX POWER .....	24
8 MIC GAIN .....	24
9 VOX .....	24
10 AUTO DIALER.....	24
11 TOT .....	24
<b>RX</b> .....	<b>25</b>
12 FM BANDWIDTH .....	25
13 RX MODE.....	25
14 SUB BAND .....	25
<b>MEMORY</b> .....	<b>26</b>
15 HOME CH.....	26
16 MEMORY LIST.....	26
17 MEMORY LIST MODE.....	26
18 PMG.....	26
<b>CONFIG</b> .....	<b>27</b>
19 BEEP .....	27
20 BAND SKIP .....	27
21 RPT ARS .....	27
22 RPT SHIFT .....	27
23 RPT SHIFT FREQ.....	27
24 RPT REVERSE.....	28
25 MIC PROGRAM KEY.....	28
26 STEP .....	28
27 CLOCK TYPE.....	28
28 APO .....	28
<b>AUDIO</b> .....	<b>29</b>
29 REAR SP OUT .....	29
30 FRONT SP MUTE .....	29
<b>SIGNALING</b> .....	<b>30</b>
31 DTMF.....	30
32 DTMF MEMORY .....	30
33 SQL TYPE .....	30
34 TONE SQL FREQ / DCS CODE .....	30
35 SQL EXPANSION.....	30
36 PAGER CODE.....	30
37 PR FREQUENCY.....	31
38 BELL RINGER.....	31
39 WX ALERT .....	31
<b>SCAN</b> .....	<b>32</b>
40 SCAN.....	32
41 DUAL RECEIVE MODE .....	32
42 DUAL RX INTERVAL.....	32
43 PRIORITY REVERT.....	32
44 SCAN RESUME .....	32
<b>DATA</b> .....	<b>33</b>
45 DATA BAND.....	33
46 DATA SPEED .....	33

<b>SD CARD</b> .....	<b>34</b>
47 BACKUP .....	34
Save the transceiver settings information .....	34
Load the transceiver settings information .....	34
48 SD INFORMATION .....	35
49 SD FORMAT .....	35
<b>OPTION</b> .....	<b>36</b>
50 Bluetooth .....	36
51 VOICE MEMORY .....	36
52 FVS REC .....	36
53 TRACK SELECT .....	36
54 FVS PLAY .....	36
55 FVS STOP .....	36
56 FVS CLEAR .....	36
57 VOICE GUIDE .....	36
<b>CLONE/RESET</b> .....	<b>37</b>
58 This -> Other .....	37
59 Other -> This .....	37
60 SOFTWARE VERSION .....	37
61 MEMORY CH RESET .....	37
62 FACTORY RESET .....	37
<b>Appendix</b> .....	<b>38</b>
The folder configuration of the micro-SD card .....	38
<b>Using the optional Swing Head Kit “SJKM-500”</b> .....	<b>39</b>
Remove the control head from the transceiver body .....	39
Attach the SJKM-500 to the control head .....	39
<b>Maintenance</b> .....	<b>40</b>
Care and maintenance .....	40
Replacing the fuse .....	40
<b>Troubleshooting</b> .....	<b>41</b>
There is no power .....	41
There is no sound .....	41
There is no transmission .....	41
The keys or knobs do not operate .....	41

# Communicating with specified stations

## Selecting the squelch type

1. Press and hold the **[F/CTCSS]** key.
2. Rotate the right **DIAL** knob to select **[33 SQL TYPE]**, then press the right **DIAL** knob.
3. Rotate the right **DIAL** knob to select the type of squelch, refer to the table below.
4. Press any key or **DIAL** knob, other than the **[F/CTCSS]** or **[Off]** key, to save the setting and return to the original operation.

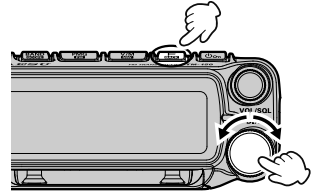

Squelch type	Description
<b>OFF</b>	Deactivates the CTCSS and DCS functions. Returns to the normal squelch operation.
<b>TONE ENC</b>	Activates the CTCSS tone for Transmissions. Receives with normal squelch operation.
<b>TONE SQL</b>	Activates the CTCSS tone squelch function.
<b>REV TONE</b>	Activates the reverse tone function. Used to monitor communications based on the squelch control system. When a signal contains the designated tone, the squelch is not opened, and when the tone signal disappears, the squelch opens, and communication starts.
<b>DCS</b>	Activates the Digital Code Squelch (DCS) function. The DCS code may be selected from 104 codes (from 023 to 754).
<b>PR FREQ</b>	Activates the no-communication squelch function for radios. The no-communication signal tone frequencies may be specified within the range of 300 Hz to 3000 Hz in steps of 100 Hz.
<b>PAGER</b>	Activates a new two-tone CTCSS pager function. When communicating with transceivers among friends, specify personal codes (each code is composed of two tones) so that only specific stations are called.
<b>DCS ENC*</b>	Transmits the signal containing the DCS CODE. Receives as a normal squelch operation.
<b>TONE DCS*</b>	Sends a tone signal when transmitting, and receives only signals with a matching DCS code.
<b>DCS TSQL*</b>	Sends a DCS CODE when transmitting and receives only signals that contain a matching tone signal when receiving.

\* Press and hold **[F/CTCSS]** key → **[35 SQL EXPANSION]** → Press the right **DIAL** knob to access “ON”, “DCS ENC”, “TONE DCS” and “DCS TSQL” setting values are activated.

- The squelch type may be set for each frequency band (BAND).
- The CTCSS and DCS squelch settings are also active during scanning. If scanning is performed with the CTCSS and DCS squelch function activated, scanning stops only when a signal containing the specified CTCSS tone or DCS code is received.
- Pressing the program key on the microphone to which the “SQL OFF” function is assigned, allows all signals that do not contain a tone or DCS code, and signals with different tones, DCS codes signals to all be heard.







## Tone squelch feature

The tone squelch opens the speaker audio only when a signal containing the specified CTCSS tone is received. The receiver will be quiet while waiting for a call from a specific station.

### Setting CTCSS Tone frequency

---

The tone may be selected from 50 frequencies (67.0 Hz to 254.1 Hz).

1. Press and hold the  key.
2. Rotate the right **DIAL** knob to select [**33 SQL TYPE**], then press the right **DIAL** knob.
3. Rotate the right **DIAL** knob to select [**TONE SQL**] then press the  key.
4. Rotate the right **DIAL** knob to select [**34 TONE SQL FREQ**], then press the right **DIAL** knob.
5. Rotate the right **DIAL** knob to select the tone frequency.
6. Press any key or **DIAL** knob, other than the  or  key, to save the setting and return to the original operation.



- The tone frequency setting is common with the squelch types as follows: "TONE ENC", "TONE SQL", "REV TONE", "TONE DCS", "DCS TSQL"
- The default setting is "100.0 Hz"





### Searching for the CTCSS Tone transmitted by the other Station

---

Search and display the CTCSS tone transmitted by the other station.



To set the transceiver operation when scanning stops, press and hold the  key → [**44 SCAN RESUME**] → press the right **DIAL** knob. This setting is common with the scan setting, tone search function and DCS search function.

1. Press and hold the  key.
2. Rotate the right **DIAL** knob to select [**33 SQL TYPE**], then press the right **DIAL** knob.
3. Rotate the right **DIAL** knob to select [**TONE SQL**] then press the  key.
4. Rotate the right **DIAL** knob to select [**34 TONE SQL FREQ**], then press the right **DIAL** knob.
5. Press and hold the microphone [**UP**] or [**DWN**] key.
  - The transceiver begins searching for a matching tone frequency.
  - When a corresponding tone frequency is detected, the searching stops and the audio is heard.
  - Press the **PTT** switch or the [**UP**] or [**DWN**] key to stop searching.
6. Press any key or **DIAL** knob, other than the  or  key, to save the setting and return to the original operation.





## Digital Code Squelch (DCS) feature

---

The Digital Code Squelch opens the speaker audio only when a signal containing the specified DCS code is received. The DCS code may be selected from 104 types (from 023 to 754).

### Setting the DCS CODE

---

1. Press and hold the  key.
2. Rotate the right **DIAL** knob to select [**33 SQL TYPE**], then press the right **DIAL** knob.
3. Rotate the right **DIAL** knob to select [**DCS**] then press the  key.
4. Rotate the right **DIAL** knob to select [**34 DCS CODE**], then press the right **DIAL** knob.
5. Rotate the right **DIAL** knob to select the DCS code.
6. Press any key or **DIAL** knob, other than the  or  key, to save the setting and return to the original operation.



- The DCS code set in the above operation is common for all transmissions with a DCS Code (“DCS”, “DCS ENC”, “TONE DCS”, “DCS TSQL”).
- The default DCS code is “023”.





### Searching for the DCS Code Used by the Other Station

---

Search for the DCS code used by the other station.





To set the transceiver operation when scanning stops, press and hold the  key → [**44 SCAN RESUME**] → press the right **DIAL** knob. This setting is common with the scan setting, tone search function and DCS search function.

1. Press and hold the  key.
2. Rotate the right **DIAL** knob to select [**33 SQL TYPE**], then press the right **DIAL** knob.
3. Rotate the right **DIAL** knob to select [**DCS**] then press the  key.
4. Rotate the right **DIAL** knob to select [**34 DCS CODE**], then press the right **DIAL** knob.
5. Press and hold the microphone [**UP**] or [**DWN**] key.
  - The transceiver begins searching for a matching DCS code.
  - When a corresponding DCS code is detected, the searching stops and the audio is heard.
  - Press the **PTT** switch or the [**UP**] or [**DWN**] key to stop searching.
6. Press any key or **DIAL** knob, other than the  or  key, to save the setting and return to the original operation.

## New Two-Tone CTCSS Pager Function

When using **FTM-150R/E** transceivers with a group of friends, setting the Two-Tone CTCSS personal codes allows calling just the specific stations. Even when the person who is called is not near the transceiver, the information on the LCD indicates that a call was received.

### Using the Pager Function

1. Press and hold the  key.
2. Rotate the right **DIAL** knob to select [**33 SQL TYPE**], then press the right **DIAL** knob.
3. Rotate the right **DIAL** knob to select [**PAGER**].
4. Press any key or **DIAL** knob, other than the  or  key, to save the setting and return to the original operation.

### Setting the Code for this Station

Set the “pager code” to be called by other stations.

1. Press and hold the  key.
2. Rotate the right **DIAL** knob to select [**36 PAGER CODE**], then press the right **DIAL** knob.



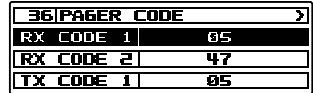

36 PAGER CODE	>
37 PR FREQUENCY	
38 BELL RINGER	
	>

3. Rotate the right **DIAL** knob to select [**RX CODE 1**] then press the right **DIAL** knob.







36 PAGER CODE	>
RX CODE 1	05
RX CODE 2	47
TX CODE 1	05

4. Rotate the right **DIAL** knob to select the RX CODE 1 of the code from 01 to 50.
5. Press the  key.
6. Rotate the right **DIAL** knob to select [**RX CODE 2**] then press the right **DIAL** knob.
7. Rotate the right **DIAL** knob to select the RX CODE 2 of the code from 01 to 50.
8. Press the  key.

The same code cannot be used for RX CODE 1 and RX CODE 2.

Next, set the pager code for directing a call to a specific partner station.

9. Press the  key.
10. Rotate the right **DIAL** knob to select [**TX CODE 1**] then press the right **DIAL** knob.
11. Rotate the right **DIAL** knob to select the TX CODE 1 of the codes from 01 to 50.
12. Press the  key.
13. Rotate the right **DIAL** knob to select [**TX CODE 2**] then press the right **DIAL** knob.
14. Rotate the right **DIAL** knob to select the TX CODE 2 of the codes from 01 to 50.  
The same code cannot be used for TX CODE 1 and TX CODE 2.
15. Press any key or **DIAL** knob, other than the  or  key, to save the setting and return to the original operation.
16. Press the **PTT** switch to transmit a call to the specific station.



- The reverse combination works as the same code, that is “05 47” is the same as “47 05”.
- If the same code is specified for all individuals, all the individuals can be called at the same time.
- The default code is “05 47”.
- When receiving the codes, the sound of the tones may be heard intermittently.



## Receiving “Pager Code” calls from a Remote Station (Standby Operation)

When the Pager function is activated, the audio of received calls with a corresponding Pager Code is heard.

Furthermore, when the Bell function (see below) is activated, the bell rings when receiving calls from the other station.

## Notification of a Call from a Remote Station by the Bell Function

The Bell may be set to sound an Alert when a call from another station containing a corresponding tone, DCS or pager code is received.



1. Press and hold the  key → [38 BELL RINGER] →  
Press the right **DIAL** knob



2. Rotate the right **DIAL** knob to select the desired number of times (1 - 8 times or continuous) the Bell rings.  
OFF/ 1 time / 3 times / 5 times / 8 times / CONTINUOUS



If the setting is “CONTINUOUS”, the bell keeps sounding until an operation is made.

3. Press any key or **DIAL** knob, other than the  or  key, to save the setting and return to the original operation, the “” icon appears on the display.

## Convenient memory function

### Programmable Memory Channel Scan (PMS)

#### Registering to the Programmable Memory Channels

50 sets of PMS memory channels (L01/U01 to L50/U50) are available.

- Register the lower and upper frequencies of the frequency range in a pair of Programmable Memory Channels.

L nn: Lower limit memory channel

U nn: Upper limit memory channel

- PMS memory channels are displayed between channel 999 and channel 001. On the Memory Channel List screen, press the **[A]** key on the microphone to jump the “L01” PMS Memory Channel.
- For more details on registering frequencies to the memory channels, see “Writing to Memory” in the Operating Manual.



- Make sure to use the corresponding numbers for the lower and upper limit memory channels.
- Set the Programmable Memory scanning (PMS) lower and upper limits as follows:
  - The lower and upper limit memory channels must be within the same frequency band.
  - The lower and upper limit memory channels must not be registered in reverse.

#### Performing Programmable Memory Channel Scan

The programmable memory channel scan allows scanning a specified frequency range within the same frequency band.

1. Press the  key to enter the memory mode.
2. Recall the PMS memory channel to which the lower limit (Lnn) or upper limit (Unn) of the frequency band is registered.
3. Press and hold the **[UP]** or **[DWN]** key of the microphone.
  - Programmable memory channel scanning starts.
  - Pressing the program key on the microphone set to the “SCAN” function also starts the PMS scan operation.
  - If the **DIAL** knob is rotated while scanning is in progress, the scanning will continue up or down in frequency according to the direction of the **DIAL** knob rotation.
4. Press the **PTT** switch or the **[UP]** or **[DWN]** key on the microphone, to cancel the scanning.

If the scanner halts on an incoming signal, the frequency will blink. Scanning will resume in about five seconds.

#### ● Disable the PMS function

1. Press the  key.  
Returns to the normal memory mode.

## Receiving Weather Broadcast Channels

This transceiver includes the preprogrammed VHF Weather Broadcast Station Memory Channel Bank, and can receive the broadcast or the weather alert by recalling or scanning a desired channel.



The following channels are stored in the transceiver weather station memory bank:

Channel No.	Frequency	Channel No.	Frequency
WX-CH01	162.550 MHz	WX-CH06	162.500 MHz
WX-CH02	162.400 MHz	WX-CH07	162.525 MHz
WX-CH03	162.475 MHz	WX-CH08	161.650 MHz
WX-CH04	162.425 MHz	WX-CH09	161.775 MHz
WX-CH05	162.450 MHz	WX-CH10	163.275 MHz

This “WX” function can only be utilized when it is assigned to a programmable key [P1] to [P4] on the microphone.

In the USA version of FTM-150R, “WX” function is assigned to P4 by factory setting.

### Assigning the “WX” function to a programmable key on the microphone

1. Press and hold the  key.
2. Rotate the right **DIAL** knob to select [25 MIC PROGRAM KEY] then press the right **DIAL** knob.
3. Rotate the right **DIAL** knob to select the [P1], [P2], [P3] or [P4] key to assign a function, then press the right **DIAL** knob.
4. Rotate the right **DIAL** knob to select [WX].
5. Press any key or **DIAL** knob, other than the  or  key, to save the setting and return to the original operation.

### Recalling the weather channels

#### Example: When “WX” is assigned to [P4]

1. Press [P4] on the microphone.  
The WX function is activated, and the weather channel selected last time the WX function was activated will be displayed on the screen.
2. Rotate the **DIAL** knob to select the other channels.
3. Press the **PTT** switch on the microphone to search for additional WX stations.  
Scanning of the channels stored in the weather station memory bank will start. When the scanning pauses on a station, press the **PTT** switch once to halt the scan, or press it twice to restart the scan.
4. Press the **PTT** switch to finish the scan.
5. Press [P4] on the microphone.  
The WX function will be inactivated and the display will return to the previous screen.

### Listening with weather alert



In the event of extreme weather disturbances, such as storms and hurricanes, the NOAA (National Oceanic and Atmospheric Administration) sends a weather alert accompanied by a 1050 Hz tone and a subsequent weather report on one of the NOAA weather channels. Receiving the weather alert tone may be disabled [39 WX ALERT] in the Setup Menu.

## DTMF Operation

DTMF (Dual Tone Multi Frequencies) are the tone signals sent to make telephone calls, or control repeaters and network links. Up to 10 registers of 16-digit DTMF tone codes can be stored as telephone numbers to make calls through the public telephone network using a phone patch or to connect through the WIRES-X analog node station.

### Registering the DTMF memory



---

1. Press and hold the  key → [32 DTMF MEMORY] → Press the right **DIAL** knob
2. Rotate the right **DIAL** knob to select the desired channel (1 to 9) to register the DTMF code, then press the right **DIAL** knob.  
The DTMF memory channel input screen is displayed.
3. Use the right **DIAL** knob or the numeric keypad of the microphone to input the DTMF code up to a maximum of 16 digits.
4. Press and hold the right **DIAL** knob to save the DTMF code.
5. Press any key or **DIAL** knob, other than the  or  key, to save the setting and return to the original operation.

### Setting the auto dialer function

---

Use the auto dialer function to automatically transmit the DTMF code registered in the DTMF memory.

1. Press and hold the  key → [10 AUTO DIALER] → Press the right **DIAL** knob
2. Rotate the right **DIAL** knob to select "ON".
3. Press any key or **DIAL** knob, other than the  or  key, to save the setting and return to the original operation.

When set to "ON", the DTMF icon "☎" will be shown on the display.

### Transmitting DTMF code automatically using DTMF memory

---

1. Set the "ON" by referring to "Transmitting the Registered DTMF Code" (above).
2. Press and hold the  key → [31 DTMF] → Press the right **DIAL** knob
3. Rotate the right **DIAL** knob to select the desired DTMF memory (1 to 9).
4. Press the **PTT** switch.
  - The DTMF code registered in the DTMF memory channel is automatically transmitted.
  - Even after releasing the **PTT** switch, the transmission continues until the DTMF code is completed. The transceiver is automatically returned to receive mode.
  - To send DTMF memory, press the number key of that number on the microphone during transmission.

### Manually Transmitting the DTMF Code

---

1. While pressing and holding the **PTT** switch, use the numeric keypad of the microphone and press each digit of the DTMF code in sequence to transmit the code.



The DTMF code can be sent manually regardless of whether the auto dialer is set to ON or OFF.

---

## Copying the Radio Data to another Transceiver

---

The memory channels and settings in the set-up menu can be copied to another **FTM-150R/E**. This is convenient when matching the settings of fellow stations that you communicate with frequently.

1. Turn both transceivers OFF.
2. Connect the clone cable “CT-166” to the DATA jack on the back of the main bodies.
3. Turn both transceivers ON.
4. On the transceiver from which data is to be copied, press and hold the  key, rotate the right **DIAL** knob to select [**58 This → Other**], then press the right **DIAL** knob. The confirmation screen appears.
5. On the transceiver to which data is to be copied, press and hold the right **DIAL** knob, rotate the right **DIAL** knob to select [**59 Other → This**], then press the right **DIAL** knob. The confirmation screen appears.
6. On the transceiver to which data is to be copied, rotate the right **DIAL** knob to select [**OK**], then press the right **DIAL** knob.
7. On the transceiver from which data is to be copied, rotate the right **DIAL** knob to select [**OK**], then press the right **DIAL** knob. The data transfer begins.
8. Turn both transceivers OFF, then disconnect the clone cable.



- 
- When “ERROR” appears on the screen during the clone operation, the operation has not completed. Check the clone cable connection, and then repeat the procedure from the beginning.
  - If the clone operation is terminated due to a power loss during the data transfer, the transceiver to which the data is copied will be reset automatically. Check the power supply, cables and connections, then repeat the procedure again from the beginning.
-

## Connecting an external device

The pin assignment of the DATA jack is as follows.

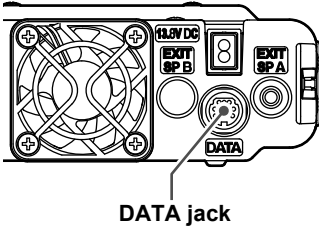

- ① PKD (packet data input)
- ② GND
- ③ PKS (PTT)
- ④ RX 9600 (9600 bps packet data output)
- ⑤ RX 1200 (1200 bps packet data output)
- ⑥ PK SQL (squelch control)
- ⑦ TXD (serial data output [transceiver → PC])
- ⑧ RXD (serial data input [transceiver ← PC])
- ⑨ CTS (data communication control)
- ⑩ RTS (data communication control)

## Connecting to a computer

### ● Preparation

- Computer
- PC connection cable “SCU-56” (Included in SCU-58) (When connecting to the USB jack of the computer.)

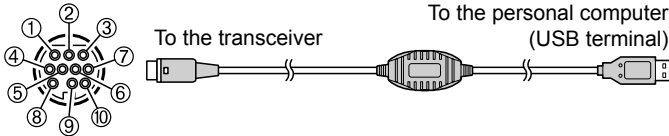

- Make sure to turn the transceiver OFF before connecting any cables.
- When using the SCU-56 PC connection cable, install the designated driver on the computer. Download the driver and installation manual from the Yaesu website.

## Using the transceiver for packet communications

A TNC (Terminal Node Controller) may be connected to the transceiver to enable packet communications.

### ● Preparation

- TNC
- Computer
- Data cable\* ... Prepare a cable suitable for the connected device.

\*The following optional products are available.

- Data cable "CT-164"

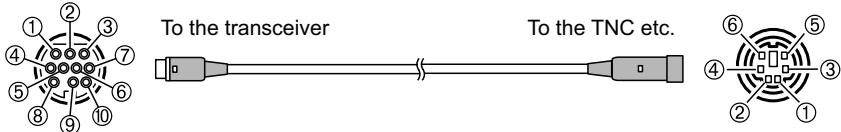

- ① PKD (packet data input)
- ② GND
- ③ PKS(PTT)
- ④ RX 9600 (9600 bps packet data output)
- ⑤ RX 1200 (1200 bps packet data output)
- ⑥ PK SQL (squelch control)
- ⑦ -
- ⑧ -
- ⑨ -
- ⑩ -

- ① PKD (packet data input)
- ② GND
- ③ PKS(PTT)
- ④ RX 9600 (9600 bps packet data output)
- ⑤ RX 1200 (1200 bps packet data output)
- ⑥ PK SQL (squelch control)

- Data cable "CT-163"

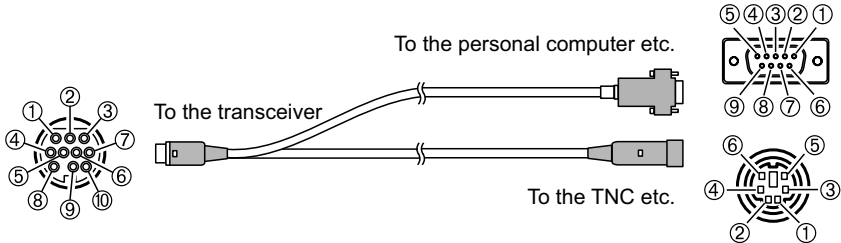

- ① PKD (packet data input)
- ② GND
- ③ PKS(PTT)
- ④ RX 9600 (9600 bps packet data output)
- ⑤ RX 1200 (1200 bps packet data output)
- ⑥ PK SQL (squelch control)
- ⑦ TXD (serial data output [transceiver → PC])
- ⑧ RXD (serial data input [transceiver ← PC])
- ⑨ CTS (data communication control)
- ⑩ RTS (data communication control)

### Dsub 9 pin

- ① -
- ② TXD (serial data output [transceiver → PC])
- ③ RXD (serial data input [transceiver ← PC])
- ④ -
- ⑤ GND
- ⑥ -
- ⑦ CTS (data communication control)
- ⑧ RTS (data communication control)
- ⑨ -

### DIN 6 pin

- ① PKD (packet data input)
- ② GND
- ③ PKS(PTT)
- ④ RX 9600 (9600 bps packet data output)
- ⑤ RX 1200 (1200 bps packet data output)
- ⑥ PK SQL (squelch control)

- Data cable “CT-167” (optional)

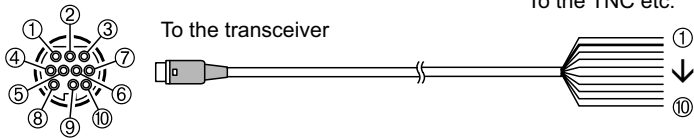

① PKD (packet data input)	① Brown PKD (packet data input)
② GND	② Black thick wire GND
③ PKS(PTT)	③ Red PKS (PTT)
④ RX 9600 (9600 bps packet data output)	④ Orange RX 9600 (9600 bps packet data output)
⑤ RX 1200 (1200 bps packet data output)	⑤ Yellow RX 1200 (1200 bps packet data output)
⑥ PK SQL (squelch control)	⑥ Green PK SQL (squelch control)
⑦ TXD (serial data output [transceiver → PC])	⑦ Blue TXD (serial data output [transceiver → PC])
⑧ RXD (serial data input [transceiver ← PC])	⑧ Grey RXD (serial data input [transceiver ← PC])
⑨ CTS (data communication control)	⑨ White CTS (data communication control)
⑩ RTS (data communication control)	⑩ Black RTS (data communication control)



- Make sure to turn the power to the radio OFF before connecting.
- Refer to the TNC operating manual for instruction on connecting the TNC to a personal computer.
- RF receive interference may occur because of noise occurring in the personal computer. When signals cannot be received normally, keep the personal computer at a distance away from the radio and use a photo-coupler and noise filter to connect.



## ● Packet communication settings

1. Press and hold the  key → [45 DATA BAND] then press the right **DIAL** knob.
2. Rotate the right **DIAL** knob to select the band to be used for the packet communication then press the right **DIAL** knob.

The setting changes in the following order:

MAIN BAND → SUB BAND → A-BAND FIX → B-BAND FIX → ...

- Refer to “45 DATA BAND” (page 33) for details.

3. Press the  key.
4. Rotate the right **DIAL** knob to select [46 DATA SPEED] then press the right **DIAL** knob.
5. Rotate the right **DIAL** knob to select the packet communication speed.  
The setting will switch between “1200 bps” and “9600 bps” then press the right **DIAL** knob.  
Factory default value: 1200bps
6. Press any key or **DIAL** knob, other than the  or  key, to save the setting and return to the original operation.

This completes the packet communication settings.



When transmitting a large volume of packet data, the transmission time gets longer, and the transceiver may heat up. When transmission continues for a long period of time, the overheating prevention circuit will act to lower the transmit power output. When transmission is continued further, transmission will be suspended automatically, and the transceiver will go into the receive mode to prevent failure due to overheating. When the overheating prevention circuit is activated and the radio goes into the receive mode, either switch the power OFF, or wait in receive mode until the transceiver cools.



## **Updating the transceiver firmware**



---

When updated firmware is available, the transceiver can be updated by connecting it to a personal computer. Download the latest version of the firmware and the firmware installation manual from the YAESU website.

## Setup Menu

The Set Mode permits configuring the various functions to accommodate individual operating needs and preferences.

### Setup Menu Operation

1. Press and hold the  key.  
The SETUP MENU screen will be displayed.
2. Rotate the Right **DIAL** knob to select the desired item in the Setup Menu, then press the Right **DIAL** knob.
  - Press the  key to return to the previous screen.
  - Rotate the Left **DIAL** knob, or press the [UP] / [DWN] key on the microphone to scroll through the 12 categories in the Setup Menu (See below):

**DISPLAY** ↔ **TX** ↔ **RX** ↔ **MEMORY** ↔ **CONFIG** ↔  
↔ **AUDIO** ↔ **SIGNALING** ↔ **SCAN** ↔ **DATA** ↔  
↔ **SD CARD** ↔ **OPTION** ↔ **CLONE/RESET**

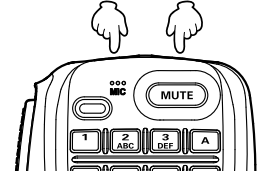
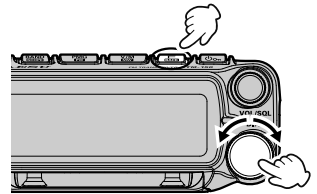
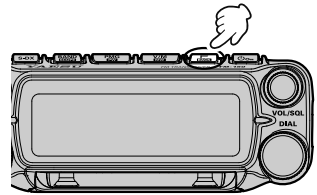

3. Press the Right **DIAL** knob.
4. When there is no deeper level of menu items, go to step 5.  
When there is a deeper level of menu items, press the Right **DIAL** knob to select the desired item, then press the Right **DIAL** knob.
5. Rotate the Right **DIAL** knob to change the setting value.
6. Press any key or **DIAL** knob, other than the Right **DIAL** knob or  key, to return to the normal operation.

## Tables of Setup Menu Operations

Menu Number / Item	Description	Selectable options (Options in bold are the default settings)
--------------------	-------------	--

### DISPLAY

<b>1 KEYPAD</b>	Enter frequency directly or display memory channel list.	-
<b>2 LCD DIMMER</b>	Sets the display and key button brightness.	MAX / MID / <b>OFF</b>
<b>3 LCD CONTRAST</b>	Sets the screen contrast.	1 - 5 - 9
<b>4 BAND SCOPE</b>	Scope Display width setting.	<b>WIDE</b> / NARROW
<b>5 S-METER SYMBOL</b>	Selects the S- & TX PO meter Symbol.	
<b>6 BACKLIGHT COLOR</b>	Set the display color.	<b>AMBER</b> / WHITE

### TX

<b>7 TX POWER</b>	Set the transmit power level.	LOW / MID / <b>HIGH</b>
<b>8 MIC GAIN</b>	Microphone sensitivity setting.	MIN / LOW / <b>NORMAL</b> / HIGH / MAX
<b>9 VOX</b>	VOX function settings.	VOX: <b>OFF</b> / LOW / HIGH DELAY: <b>0.5s</b> / 1.0s / 1.5s / 2.0s / 2.5s / 3.0s VOX MIC: <b>FRONT</b> / REAR
<b>10 AUTO DIALER</b>	DTMF code automatic transmit setting.	ON / <b>OFF</b>
<b>11 TOT</b>	TX time out setting.	<b>OFF</b> / 1min / 2min / 3min / 5min / 10min / 15min / 20min / 30min (3min: USA version)

### RX

<b>12 FM BANDWIDTH</b>	Set the FM transmit modulation level.	<b>WIDE</b> / NARROW
<b>13 RX MODE</b>	Select the receive mode.	<b>AUTO</b> / FM / AM
<b>14 SUB BAND</b>		
SUB BAND	Sub Band ON/OFF.	<b>OFF</b> / ON
SUBBAND MUTE	Sub Band mute setting	<b>OFF</b> / ON

### MEMORY

<b>15 HOME CH</b>	Recall the home channel.	-
<b>16 MEMORY LIST</b>	Displays the Memory channel list screen.	-
<b>17 MEMORY LIST MODE</b>	Displays a list of memory channels in memory mode.	ON / <b>OFF</b>
<b>18 PMG</b>		
PMG TIMER	Scan resume time after there is no signal when receiving in PMG mode simultaneously.	<b>0.5sec</b> / 1sec / 2sec
PMG CLEAR	Cancel the registration of all PMG channels.	-

### CONFIG

<b>19 BEEP</b>	Beep volume setting.	OFF / <b>LOW</b> / HIGH
<b>20 BAND SKIP</b>	Set the frequency bands that can be selected.	AIR: <b>ON</b> / OFF VHF: <b>ON</b> / OFF UHF: <b>ON</b> / OFF OTHER: <b>ON</b> / OFF
<b>21 RPT ARS</b>	Repeater auto shift setting.	OFF / <b>AUTO</b>
<b>22 RPT SHIFT</b>	Repeater shift direction setting.	<b>AUTO</b> / -RPT / +RPT
<b>23 RPT SHIFT FREQ</b>	Repeater TX offset setting.	0.00MHz to 99.95MHz
<b>24 RPT REVERSE</b>	Reverses the transmit and receive frequencies while working through a repeater.	<b>NORMAL</b> / REVERSE

Menu Number / Item	Description	Selectable options (Options in bold are the default settings)
25 MIC PROGRAM KEY	Microphone P1 / P2 / P3 / P4 buttons programmable settings.	OFF / 2nd PTT / SCAN / HOME CH / RPT SHIFT / REVERSE / TX POWER / SQL OFF / T-CALL / VOICE* / WX / DW (*requires optional FVS-2) P1: <b>2nd PTT</b> P2: <b>HOME CH</b> P3: <b>TX POWER</b> P4: <b>WX (T-CALL: European version)</b>
26 STEP	Frequency tuning step.	<b>AUTO</b> / 5.00 kHz / 6.25 kHz / (8.33 kHz) / 10.00 kHz / 12.50 kHz / 15.00kHz / 20.00kHz / 25.00 kHz / 50.00 kHz / 100 kHz (8.33kHz: only for Air band)
27 CLOCK TYPE	Clock shift setting.	<b>A</b> / B
28 APO	Automatic power OFF time setting.	<b>OFF</b> / 0.5hour to 2.0hour (0.5 hour steps) / 2.0hour to 12.0hour (1.0 hour steps)

## AUDIO

29 REAR SP OUT	Output level of the main body speaker	0% to <b>100%</b>
30 FRONT SP MUTE	Front speaker operation settings when external speakers are connected.	<b>CONTINUE</b> / AUTO MUTE

## SIGNALING

31 DTMF	Load DTMF Autodialer Memories.	-
32 DTMF MEMORY	Set the DTMF auto dialer channel and code (16 characters).	1 to 9
33 SQL TYPE	Select a squelch type.	<b>OFF</b> / TONE ENC / TONE SQL / REV TONE / DCS / PR FREQ / PAGER/ (DCS ENC)/(TONE DCS)/(DCS TSQL) *The options in the parentheses are available when the SQL expansion is ON.
34 TONE SQL FREQ or DCS CODE	Set the CTCSS Tone Frequency or the DCS code.	CTCSS: 67.0Hz to 254.1Hz ( <b>100Hz</b> ) DCS: <b>023</b> to 754
35 SQL EXPANSION	Separate squelch type setting for transmit and receive.	ON / <b>OFF</b>
36 PAGER CODE	Pager individual code settings.	RX-CODE 1: 01 - <b>05</b> - 50 RX-CODE 2: 01 - <b>47</b> - 50 TX-CODE 1: 01 - <b>05</b> - 50 TX-CODE 2: 01 - <b>47</b> - 50
37 PR FREQUENCY	User programmed reverse tone frequency.	300Hz - <b>1500Hz</b> - 3000Hz
38 BELL RINGER	Recall sound length setting.	<b>OFF</b> / 1 time / 3 times / 5 times / 8 times / CONTINUOUS
39 WX ALERT	Weather alert operation setting.	ON / <b>OFF</b>

## SCAN

40 SCAN	Engages the Scan operation.	-
41 DUAL RECEIVE MODE	Dual receive operation setting.	<b>OFF</b> / PRIORITY SCAN
42 DUAL RX INTERVAL	Dual receive reception interval setting. (Only enabled when "41 DUAL RECEIVE MODE" is set to "PRIORITY SCAN".)	0.5sec / 1.0sec / 2.0sec / 3.0sec / <b>5.0sec</b> / 7.0sec / 10sec
43 PRIORITY REVERT	The transmission operation during dual receive always transmits on the home channel.	<b>OFF</b> / ON
44 SCAN RESUME	Set the resume operation after scanning stops on a signal.	<b>BUSY</b> / HOLD / 1sec / 3sec / 5sec

Menu Number / Item	Description	Selectable options (Options in bold are the default settings)
--------------------	-------------	--

## DATA

<b>45 DATA BAND</b>	DATA band selection settings.	MAIN BAND / SUB BAND / A-BAND FIX / <b>B-BAND FIX</b>
<b>46 DATA SPEED</b>	DATA communication baud rate settings.	<b>1200 bps</b> / 9600 bps

## SD CARD

<b>47 BACKUP</b>		
<b>WRITE TO SD</b>	Saves the transceiver setting information to a microSD memory card.	
<b>ALL MEMORY SETUP</b>	Copies all data. Copies only the memory channels. Copies only the set-up menu settings.	
<b>READ FROM SD</b>	Loads the information to the transceiver from a microSD memory card.	
<b>ALL MEMORY SETUP</b>	Copies all data. Copies only the memory channels. Copies only the set-up menu settings.	
<b>48 SD INFORMATION</b>	Displays the total capacity and free space of the microSD Card.	–
<b>49 SD FORMAT</b>	Initializing the micro-SD card.	–

## OPTION

<b>111 Bluetooth</b> (Requires optional Bluetooth® Unit BU-5)		
<b>Bluetooth</b>	Bluetooth headset setting.	<b>OFF</b> / ON
<b>DEVICE</b>	Bluetooth device list.	–
<b>AUDIO</b>	Set whether received audio is heard from both the Bluetooth® headset and the transceiver speaker, or only from the connected Bluetooth® device.	<b>AUTO</b> / FIX
<b>112 VOICE MEMORY</b> (Requires optional Voice Guide Unit FVS-2)		
<b>PLAY/REC</b>	Recording operation settings.	<b>FREE 5min</b> / LAST 30sec
<b>ANNOUNCE</b>	Setting conditions for frequency announcement.	OFF / <b>MANUAL</b> / <b>AUTO</b>
<b>LANGUAGE</b>	Setting the language to announce.	<b>ENGLISH</b> / JAPANESE
<b>VOLUME</b>	Setting the announcement volume.	<b>HIGH</b> / MID / LOW
<b>RX MUTE</b>	Setting to mute received audio during announcements and playback.	<b>ON</b> / OFF
<b>113 FVS REC</b>	Start recording the received audio.	–
<b>114 TRACK SELECT</b>	Selecting the audio track to play.	<b>ALL</b> / 1 - 8
<b>115 FVS PLAY</b>	Start playing the recorded sound	–
<b>116 FVS STOP</b>	Stop recording / playing	–
<b>117 FVS CLEAR</b>	Erase all recorded audio	–
<b>118 VOICE GUIDE</b>	The frequency of the operating band will be announced.	–

## CLONE/RESET

<b>119 This → Other</b>	Send all settings to other FTM-150R/E	–
<b>120 Other → This</b>	Receive all settings from other FTM-150R/E	–
<b>121 SOFTWARE VERSION</b>	Display the software version.	Main Ver. / Sub Ver.
<b>122 MEMORY CH RESET</b>	Erase registered memory channels.	–
<b>123 FACTORY RESET</b>	Return all settings to factory default.	–

# Setup Menu Operations

## DISPLAY

### 1 KEYPAD

In VFO mode, the screen for direct input of frequency is displayed, and in memory mode, the screen for direct input of Memory Channel number is displayed. Select the [MEM CH] button on this screen and press the right **DIAL** knob to open the memory channel input screen.

1. Press and hold the  key → [1 **KEYPAD**] → Press the right **DIAL** knob
2. Rotate the **FUNC** knob to select a number and press the right **DIAL** knob to enter.

**NOTE:** This item is registered in the custom function menu by factory setting.

### 2 LCD DIMMER

The brightness of the display and key buttons can be changed.

1. Press and hold the  key → [2 **LCD DIMMER**] → Press the right **DIAL** knob
2. Rotate the right **DIAL** knob to select the brightness from the following 3 levels:

**MAX / MID / OFF**

### 3 LCD CONTRAST

Adjust the contrast of the display.

1. Press and hold the  key → [3 **LCD CONTRAST**] → Press the right **DIAL** knob
2. Rotate the right **DIAL** knob to adjust the contrast.

1 - 5 - 9

### 4 BAND SCOPE

Set the number of channels to be displayed when the BAND SCOPE function is used.

1. Press and hold the  key → [4 **BAND SCOPE**] → Press the right **DIAL** knob
2. Rotate the right **DIAL** knob to select the number of channels to search.

<b>WIDE</b>	47 channels (VFO mode), 23 channels (Memory mode)
<b>NARROW</b>	23 channels (VFO mode), 13 channels (Memory mode)

Refer to the Operating Manual for details.

### 5 S-METER SYMSBOL

Select the S & TX PO meter symbol.

1. Press and hold the  key → [5 **S-METER SYMBOL**] → Press the right **DIAL** knob
2. Rotate the right **DIAL** knob to select the desired meter symbol type.



## 6 BACKLIGHT COLOR

---

Changes the background color of the display.

1. Press and hold the  key key → [6 BACKLIGHT COLOR] → Press the right **DIAL** knob
2. Rotate the right **DIAL** knob to select the desired color.  
**AMBER / WHITE**

# TX

## 7 TX POWER

Set the transmit power output.

1. Press and hold the  key → [7 TX POWER] → Press the right **DIAL** knob
2. Rotate the right **DIAL** knob to select the TX power output.

“LOW” ↔ “MID” ↔ “HIGH”

HIGH	MID	LOW
55W (144MHz) 50W (430MHz)	25W	5W

**NOTE:** This item is registered in the custom function menu by factory setting.

## 8 MIC GAIN

The sensitivity (gain) of the microphone can be adjusted.

1. Press and hold the  key → [8 MIC GAIN] → Press the right **DIAL** knob
2. Rotate the right **DIAL** knob to select the desired setting.

The sensitivity can be selected from the following 5 levels.

MIN / LOW / **NORMAL** / HIGH / MAX

## 9 VOX

Set the VOX (Voice Operated Transmit) function ON/OFF, and VOX delay time.

1. Press and hold the  key → [11 VOX] → Press the right **DIAL** knob

Refer to the Operating Manual for details.

## 10 AUTO DIALER

Set method (Auto or Manual) to transmit the registered DTMF code.

1. Press and hold the  key → [10 AUTO DIALER] → Press the right **DIAL** knob
2. Rotate the right **DIAL** knob to select the desired setting.

ON	The auto dialer function is enabled.
OFF	The auto dialer function is disabled.

For details, see “Setting the auto dialer function” (page 12).

## 11 TOT

The transceiver will automatically return to receive after transmitting continuously for a specified time.

1. Press and hold the  key → [11 TOT] → Press the right **DIAL** knob
2. Rotate the right **DIAL** knob to select the desired setting.

OFF / 1 min / 2 min / 3 min / 5 min / 10 min / 15 min / 20 min / 30 min



When the time-out-timer is active, a beep is sounded when a continuous transmission nears the set time. About 10 seconds later, the transceiver returns to the receive mode.

The default settings depend on the transceiver version.



## 12 FM BANDWIDTH

The modulation can be set to half of its usual level.

Select "WIDE" for normal amateur radio operation.

1. Press and hold the  key → [12 FM BANDWIDTH] → Press the right **DIAL** knob
2. Rotate the right **DIAL** knob to select the desired setting.

<b>WIDE</b>	Normal transmit modulation level.
<b>NARROW</b>	Modulation is half of the normal level.

## 13 RX MODE

Manually switch to a suitable mode (radio wave type) for the operating frequency band.

1. Press and hold the  key → [13 RX MODE] → Press the right **DIAL** knob
2. Rotate the right **DIAL** knob to select the mode.

<b>AUTO</b>	Automatically switches the modulation mode to match the frequency band.
<b>FM</b>	Switches to the FM mode.
<b>AM</b>	Switches to the AM mode.

## 14 SUB BAND

The Sub Band display (right part of the screen) can be hidden. Also, while receiving a signal on the Main Band, the Sub Band audio can be automatically muted.

1. Press and hold the  key → [14 SUB BAND] → Press the right **DIAL** knob  
The parameter settings screen appears.

### SUB BAND

The Sub Band display is hidden.

1. Rotate the right **DIAL** knob to select [SUB BAND] then press the right **DIAL** knob.
2. Rotate the right **DIAL** knob to select the desired setting then press the right **DIAL** knob.

<b>OFF</b>	The Sub Band (right part of the screen) is not displayed.
<b>ON</b>	The Sub Band (right part of the screen) is displayed.

### SUBBAND MUTE

The receive audio of the Sub Band can be automatically muted when receiving signals in the Main Band.

1. Rotate the right **DIAL** knob to select [SUBBAND MUTE] then press the right **DIAL** knob.
2. Rotate the right **DIAL** knob to select the desired setting.

<b>OFF</b>	The Sub Band audio will not be muted when a signal is received on the Main Band.
<b>ON</b>	The Sub Band audio will be muted when a signal is received on the Main Band.

# MEMORY

## 15 HOME CH

Recalls the home channel of the current band.

1. Press and hold the  key → [15 HOME CH] → Press the right **DIAL** knob

## 16 MEMORY LIST

Displays the Memory channel list screen.

1. Press and hold the  key → [16 MEMORY LIST] → Press the right **DIAL** knob

## 17 MEMORY LIST MODE

Set the memory channel list to be displayed by rotating the **DIAL** knob, confirming the contents of the memory, and then press **DIAL** knob to recall the memory channel.

1. Press and hold the  key → [17 MEMORY LIST MODE] → Press the right **DIAL** knob

Refer to the Operating Manual for details.

## 18 PMG

Cancel the registration of all PMG channels.

1. Press and hold the  key → [18 PMG] → Press the right **DIAL** knob  
The parameter settings screen appears.

### PMG TIMER

Scan resume time after there is no signal when receiving in PMG mode simultaneously.

1. Rotate the right **DIAL** knob to select [PMG TIMER] then press the right **DIAL** knob.
2. Rotate the right **DIAL** knob to select the desired setting.

**0.5sec** / 1sec / 2sec

### PMG CLEAR

Cancel the registration of all PMG channels..

1. Rotate the right **DIAL** knob to select [PMG CLEAR] then press the right **DIAL** knob.  
The confirmation screen will be displayed.
2. Rotate the right **DIAL** knob to select [OK], then press the right **DIAL** knob.

# CONFIG

## 19 BEEP

Adjust the volume of the beep that sounds when a key is pressed.

1. Press and hold the  key → [23 BEEP] → Press the right **DIAL** knob
2. Rotate the **FUNC** knob to select the desired setting.

The Beep volume can be selected from 3 levels.

OFF / **LOW** / HIGH

## 20 BAND SKIP

Set the band selected when the  key is pressed.

1. Press and hold the  key → [20 BAND SKIP] → Press the right **DIAL** knob
2. Rotate the right **DIAL** knob to select the band to be set with a press the right **DIAL** knob.
3. Rotate the right **DIAL** knob to set "ON" (selectable) or "OFF" (not selectable).

AIR: OFF / **ON** (108MHz - 137MHz)

VHF: OFF / **ON** (137MHz - 174MHz)

UHF: OFF / **ON** (400MHz - 550MHz)

OTHER: OFF / **ON** (174MHz - 400MHz)

## 21 RPT ARS

Set the auto repeater shift function.

1. Press and hold the  key → [21 RPT ARS] → Press the right **DIAL** knob
2. Rotate the right **DIAL** knob to select the desired setting.

<b>AUTO</b>	The auto repeater shift function is enabled.
<b>OFF</b>	The auto repeater shift function is disabled.

**NOTE:** This item is registered in the custom function menu by factory setting.

## 22 RPT SHIFT

Set the direction of the repeater transmit shift setting.

1. Press and hold the  key → [22 RPT SHIFT] → Press the right **DIAL** knob
2. Rotate the right **DIAL** knob to select the shift direction setting.

<b>AUTO</b>	The transmit frequency will not shift.
<b>-RPT</b>	The transmit frequency will shift down.
<b>+RPT</b>	The transmit frequency will shift up.

## 23 RPT SHIFT FREQ

Set the repeater transmit shift offset frequency.

1. Press and hold the  key → [23 RPT SHIFT FREQ] → Press the right **DIAL** knob
2. Rotate the right **DIAL** knob to select the desired repeater transmit shift offset frequency.

The offset can be set at 0.05 MHz intervals between 0.00 MHz and 99.95 MHz.

The default setting differs depending on frequency.

## 24 RPT REVERSE

The “reverse” operation temporarily reverses the transmit and receive frequencies. This permits checking to find if direct communication with the other station is possible.

1. Press and hold the  key → [24 RPT REVERSE] → Press the right **DIAL** knob
  - The transmit and receive frequencies are temporarily reversed (“reverse” state).
  - In the “reverse” state, the “-” or “+” blinks on the display.
2. To release the reverse state, repeat the above steps again.

**NOTE:** This item is registered in the custom function menu by factory setting.

## 25 MIC PROGRAM KEY

Functions can be assigned to the program keys (P1 to P4) on the provided microphone (SSM-85D).

1. Press and hold the  key → [25 MIC PROGRAM KEY] → Press the right **DIAL** knob

Refer to the Operating Manual for details.

## 26 STEP

Set the frequency step when the tuning knob is turned, or when the key is pressed.

1. Press and hold the  key → [26 STEP] → Press the right **DIAL** knob

Refer to the Operating Manual for details.

## 27 CLOCK TYPE

The CPU clock signal can be changed so that an internal spurious signal is not heard by the receiver. Select “A” during normal operation.

1. Press and hold the  key → [27 CLOCK TYPE] → Press the right **DIAL** knob
2. Rotate the right **DIAL** knob to select the desired setting.

<b>A</b>	The clock shift operation will automatically switch ON and OFF.
<b>B</b>	The clock shift will always be kept in operation.

## 28 APO

The transceiver can be set to automatically power OFF when there is no operation for a period.

1. Press and hold the  key → [28 APO] → Press the right **DIAL** knob
2. Rotate the right **DIAL** knob to select the desired setting.

<b>OFF</b>	Does not turn the power OFF automatically.
0.5 hour to 12 hour	Turns the power OFF when no operation is performed for a specified time.

# AUDIO

## 29 REAR SP OUT

Adjust the output level of the main body speaker.

1. Press and hold the  key → [29 REAR SP OUT] → Press the right **DIAL** knob
2. Rotate the right **DIAL** knob to adjust the output level.  
0% to **100%** (10% steps)

## 30 FRONT SP MUTE

Front speaker operation settings when external speakers are connected.

1. Press and hold the  key → [30 FRONT SP MUTE] → Press the right **DIAL** knob
2. Rotate the right **DIAL** knob to select the desired setting.

<b>CONTINUE</b>	The Front speaker audio will not be muted when external speakers are connected.
<b>AUTO MUTE</b>	The Front speaker audio will be muted when external speakers are connected.

# SIGNALING

## 31 DTMF

Select the registered DTMF memory 0 to 9 and press **PTT** to automatically send the DTMF code.

1. Press and hold the  key → **[31 DTMF]** → Press the right **DIAL** knob
2. Rotate the right **DIAL** knob to select the desired DTMF memory (1 to 9).
3. Press **PTT**.

For details, see “Transmitting DTMF code automatically using DTMF memory” (page 12).

## 32 DTMF MEMORY

Register the DTMF memory (maximum 16 digits, 9 channels) for automatic transmission with the auto dialer.

1. Press and hold the  key → **[32 DTMF MEMORY]** → Press the right **DIAL** knob

For details, see “Registering the DTMF memory” (page 12).

## 33 SQL TYPE

Selecting the squelch type.

1. Press and hold the  key → **[33 SQL TYPE]** → Press the right **DIAL** knob

For details, see “Selecting the squelch type” (page 5).

## 34 TONE SQL FREQ / DCS CODE

Set the tone frequency or DCS code.

1. Press and hold the  key → **[34 TONE SQL FREQ]\*** or **[34 DCS CODE]\*** → Press the right **DIAL** knob

\*The item name changes automatically depending on the setting of “33 SQL TYPE”.

## 35 SQL EXPANSION

The squelch type can be set separately for transmit and receive.

1. Press and hold the  key → **[35 SQL EXPANSION]** → Press the right **DIAL** knob
2. Rotate the right **DIAL** knob to select the desired setting.

<b>ON</b>	Add squelch types for signaling.
<b>OFF</b>	Does not add squelch types for signaling.

## 36 PAGER CODE

The new pager code permits calls to specific stations only.

1. Press and hold the  key → **[36 PAGER CODE]** → Press the right **DIAL** knob

For details, see “Setting the Code for this Station” (page 8).

## 37 PR FREQUENCY

Set a no-communication squelch CTCSS tone from 300 Hz to 3000 Hz in 100 Hz steps.

1. Press and hold the  key → **[37 PR FREQUENCY]** → Press the right **DIAL** knob
2. Rotate the right **DIAL** knob to select the desired CTCSS tone frequency.  
300Hz to 3000Hz (100Hz steps)

## 38 BELL RINGER

The beep may be set to sound an alert when a call is received from another station.

1. Press and hold the  key → **[38 BELL RINGER]** → Press the right **DIAL** knob

For details, see “Notification of a Call from a Remote Station by the Bell Function” (page 9).

## 39 WX ALERT

Setting the weather Alert Feature, to notify of storms and hurricanes, ON or OFF.

1. Press and hold the  key → **[39 WX ALERT]** → Press the right **DIAL** knob
2. Press the right **DIAL** knob to select the desired setting.

<b>ON</b>	Enables the Weather Alert Feature.
<b>OFF</b>	Disables the Weather Alert Feature.

# SCAN

## 40 SCAN

Start or stop scanning for channels in VFO mode or Memory mode.

1. Press and hold the  key → [40 SCAN] → Press the right **DIAL** knob

Refer to the Operating Manual for details.

## 41 DUAL RECEIVE MODE

Activate the Priority Scan function.

1. Press and hold the  key → [41 DUAL RECEIVE MODE] → Press the right **DIAL** knob
2. Rotate the right **DIAL** knob to select the desired setting.

**OFF / PRIORITY SCAN**

Refer to the Operating Manual for details.

## 42 DUAL RX INTERVAL

Set the time interval to check for a signal on the priority channel (HOME channel) during the priority scan.

1. Press and hold the  key → [42 DUAL RX INTERVAL] → Press the right **DIAL** knob
2. Rotate the right **DIAL** knob to select the desired setting.

0.5sec / 1.0sec / 2.0sec / 3.0sec / **5.0sec** / 7.0sec / 10sec

Refer to the Operating Manual for details.

## 43 PRIORITY REVERT

Set to always Transmit on the priority channel (HOME channel) when PTT is pressed during dual receive operation.

1. Press and hold the  key → [43 PRIORITY REVERT] → Press the right **DIAL** knob
2. Rotate the right **DIAL** knob to select the desired setting.

<b>ON</b>	Always send on the priority channel (HOME channel).
<b>OFF</b>	Sends at the currently displayed frequency.

## 44 SCAN RESUME

Set the time interval to resume scanning after a received signal ends during scanning.

1. Press and hold the  key → [44 SCAN RESUME] → Press the right **DIAL** knob
2. Rotate the right **DIAL** knob to select the desired setting.

<b>BUSY</b>	Continue receiving the frequency until the signal disappears.
<b>HOLD</b>	Stop scanning and receive that frequency.
1 sec / 3 sec / 5 sec	Restart scanning after receiving the frequency for the set amount of time.

The default settings depend on the transceiver version.



## 45 DATA BAND

Set the operating band of the data communication (when using the DATA jack at the back of the main body).

1. Press and hold the  key key → **[45 DATA BAND]** → Press the right **DIAL** knob
2. Rotate the right **DIAL** to select the DATA communication operating band, then press the right **DIAL** knob.

<b>MAIN BAND</b>	Always operate on the Main Band (The band displayed with large numbers is the “Main Band”).
<b>SUB BAND</b>	Always operate on the Sub Band (The band that is indicated in small numbers is the “Sub Band”).
<b>A-BAND FIX</b>	Always operate on the left side band of the display.
<b>B-BAND FIX</b>	Always operate on the right side band of the display.

## 46 DATA SPEED

Set the baud rate of the data communication (when using the DATA jack at the back of the main body).

1. Press and hold the  key key → **[46 DATA SPEED]** → Press the right **DIAL** knob  
The screen for the detailed settings will be displayed.
2. Rotate the right **DIAL** to select the data communication speed, then press the right **DIAL** knob.

The setting switches as follows:

**1200 bps / 9600 bps**

## 47 BACKUP

The transceiver settings information can be saved to a microSD memory card, also the saved settings can be loaded to the transceiver.

### Save the transceiver settings information

Up to 10 items can be saved in each area. If more than 10 items are saved, the oldest information will be overwritten.

1. Press and hold the  key → **[47 BACKUP]** → Press the right **DIAL** knob.
2. Rotate the right **DIAL** knob to select **[WRITE TO SD]**, then press the right **DIAL** knob.
3. Rotate the right **DIAL** knob to select the files to be copied, then press the right **DIAL** knob.

ALL	Copies all data.
MEMORY	Copies only the memory channels and backtrack position information.
SETUP	Copies only the set-up Menu settings.

4. Rotate the right **DIAL** knob to select **[OK]**, then press the right **DIAL** knob. When copying is completed, “Completed” and “File name” will be displayed.
  - The file names will be assigned automatically. They cannot be changed.
  - See page 38 for the saved location of each file.

Area to save	File name (up to 10)
ALL	CLNFTM15000 to CLNFTM15009
MEMORY	MEMFTM15000 to MEMFTM15009
SETUP	SYSFTM15000 to SYSFTM15009

### Load the transceiver settings information

1. Press and hold the  key → **[47 BACKUP]** → Press the right **DIAL** knob.
2. Rotate the right **DIAL** knob to select **[READ FROM SD]**, then press the right **DIAL** knob.
3. Rotate the right **DIAL** knob to select the file to be copied, then press the right **DIAL** knob.

ALL	Copies all data.
MEMORY	Copies only the memory channels and backtrack position information.
SETUP	Copies only the set-up Menu settings.

4. A list of files saved on the microSD memory card will be displayed.
5. Rotate the right **DIAL** knob to select the file to be copied, then press the right **DIAL** knob.
6. Rotate the right **DIAL** knob to select **[OK]**, then press the right **DIAL** knob.
7. When loading is complete, “Completed” is displayed on the screen, and then the transceiver automatically restarts.

## 48 SD INFORMATION

---

Display information from SD Memory Card.

1. Press and hold the  key → [48 MEMORY INFO] → Press the right **DIAL** knob  
The bar graph and the following information will be displayed:

Used space : xx,xxx MB

Free space : xx,xxx MB

Capacity : xx,xxx MB

## 49 SD FORMAT

---

Initialize a new micro-SD memory card.



Formatting a microSD memory card erases all data saved on it. Before formatting the card, be sure to check for data and save it before formatting.

---

1. Press and hold the  key → [49 FORMAT] → Press the right **DIAL** knob  
The confirmation screen will be displayed.
2. To format the microSD card, turn the right **DIAL** knob to select [OK] and then press the right right **DIAL** knob.

Refer to the Operating Manual for details.

## OPTION

### 50 Bluetooth

Make Bluetooth® settings and connect to the optional Bluetooth Headset SSM-BT10.

1. Press and hold the  key → **[50 Bluetooth]** → Press the right **DIAL** knob

Refer to the Operating Manual for details.

### 51 VOICE MEMORY

Make settings related to the (optional) FVS-2 voice guide unit attached to the transceiver.

1. Press and hold the  key → **[51 VOICE MEMORY]** → Press the right **DIAL** knob

Refer to the Operating Manual for details.

### 52 FVS REC

Start recording the received audio using the (optional) FVS-2 voice guide unit.

1. Press and hold the  key → **[52 FVS REC]** → Press the right **DIAL** knob

Refer to the Operating Manual for details.

### 53 TRACK SELECT

Select the track to play on the (optional) FVS-2 voice guide unit.

1. Press and hold the  key → **[53 TRACK SELECT]** → Press the right **DIAL** knob

Refer to the Operating Manual for details.

### 54 FVS PLAY

Plays the audio recorded of the (optional) FVS-2 voice guide unit.

1. Press and hold the  key → **[54 FVS PLAY]** → Press the right **DIAL** knob

Refer to the Operating Manual for details.

### 55 FVS STOP

Stops playback or recording of the (optional) FVS-2 voice guide unit.

1. Press and hold the  key → **[55 FVS STOP]** → Press the right **DIAL** knob

### 56 FVS CLEAR

All audio recorded using the (optional) FVS-2 voice guide unit is erased at once.

1. Press and hold the  key → **[56 FVS CLEAR]** → Press the right **DIAL** knob

Refer to the Operating Manual for details.

### 57 VOICE GUIDE

Use the (optional) FVS-2 voice guide unit to announce the operating frequency by voice.

1. Press and hold the  key → **[57 VOICE GUIDE]** → Press the right **DIAL** knob

Refer to the Operating Manual for details.

## CLONE/RESET

### 58 This -> Other

All the data saved on the transceiver directory may be copied (Cloned) to other **FTM-150R/E** transceivers.

For details, see “Copying the Radio Data to another Transceiver” (page 13).

### 59 Other -> This

All the data saved on the transceiver directory may be copied (Cloned) from other **FTM-150R/E** transceivers.

For details, see “Copying the Radio Data to another Transceiver” (page 13).

### 60 SOFTWARE VERSION

Display the software versions.

1. Press and hold the  key → **[60 SOFTWARE VERSION]** → Press the right **DIAL** knob  
The software versions of “Main” and “Sub” are shown.

### 61 MEMORY CH RESET

Delete the registered data from the memory channels.

1. Press and hold the  key → **[61 MEMORY CH RESET]**
2. Press the right **DIAL** knob.  
The confirmation screen will be displayed.
3. Rotate the right **DIAL** knob to select **[OK]**, then press the right **DIAL** knob.  
Erase all memory channels and the transceiver will restart.

### 62 FACTORY RESET

To restore all transceiver settings and memory content to the factory defaults.

1. Press and hold the  key → **[62 FACTORY RESET]** → Press the right **DIAL** knob  
The confirmation screen will be displayed.
2. Rotate the right **DIAL** knob to select **[OK]** then press the right **DIAL** knob.  
When all information is erased, the transceiver will automatically restart, and the call sign input screen will be displayed.

### The folder configuration of the micro-SD card

A commercially available microSD memory card may be inserted into the **FTM-150R/E** to save various data files. The parameters of each function are stored in the following folders.

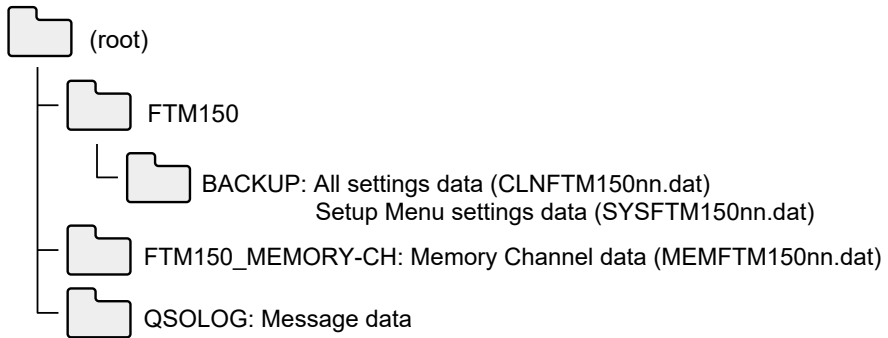

## Using the optional Swing Head Kit "SJKM-500"

Freely change the angle of the control head up, down, left, or right.

### Remove the control head from the transceiver body

To install the SJKM-500 Swing Head Kit, remove the control head from the transceiver body.

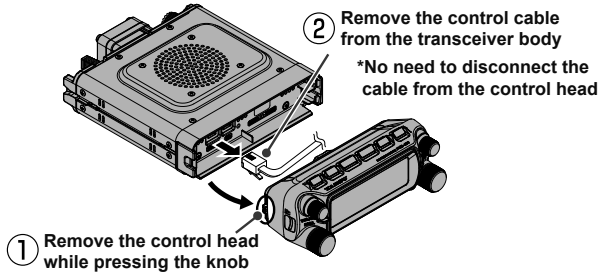

### Attach the SJKM-500 to the control head

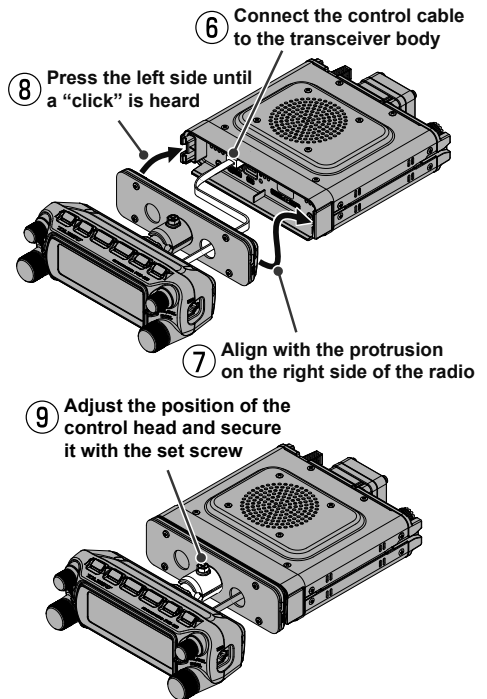
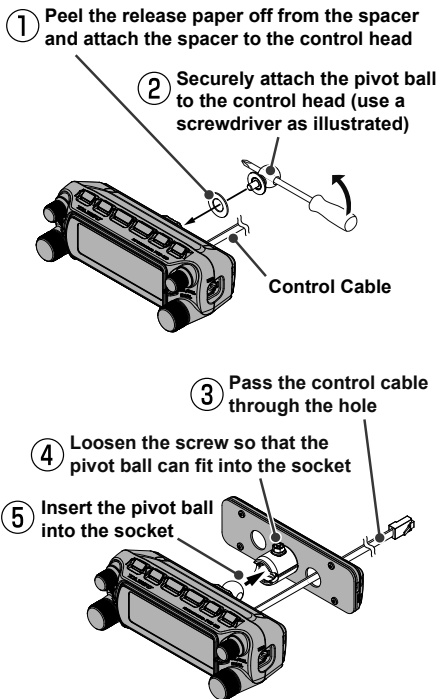

# Maintenance

## Care and maintenance

Turn the power OFF before wiping away any dust and stains on the transceiver with a dry soft cloth. For stubborn stains, slightly moisten a soft cloth and wring it out before using it to wipe away the stains.



Never use washing detergents and organic solvents (thinner, benzene, etc.). Doing so may result in paint flaking or damage to the transceiver finish.

## Replacing the fuse

When the fuse of the DC power supply cable blows and the transceiver becomes inoperable, correct the cause of the problem, and then replace the fuse with a new one of the correct (15 Amp) rating.



When replacing the fuse, be sure to disconnect the power supply cable from the transceiver and from the external DC power supply.

### ● Replacing the fuse of the DC power supply cable

1. Prepare a new fuse.

Use a fuse with a rating of 15A.



Never attempt to use a fuse that is not of the specified rating

2. Open the fuse holder as shown in the diagram on the right.

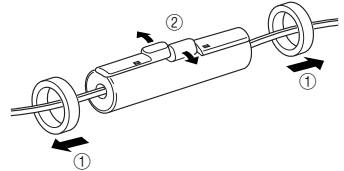

3. Remove the blown fuse.

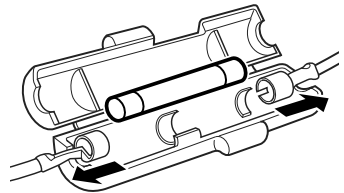

4. Attach the new fuse.
5. Close the fuse holder.

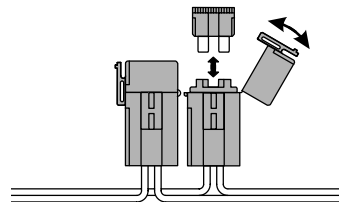

European version



## Troubleshooting

**Check the following before requesting repair services.**

### **There is no power**

---

- **Is the external power supply connected correctly?**  
Connect the black wire to the negative (-) terminal and the red wire to the positive (+) terminal.
- **Is the voltage and current capacity of the external power supply sufficient?**  
Check the voltage and current capacity of the external power supply.  
Voltage: 13.8V  
Current capacity: 15A or higher
- **Is the fuse blown?**  
Replace the fuse.

### **There is no sound**

---

- **Is the squelch level or setting too high?**  
Adjust the squelch level when receiving weak signals.
- **Is the volume low?**  
Increase the volume by turning the VOL/SQL knob in the clockwise direction.
- **Is the tone squelch or DCS set to on?**  
When the tone squelch or DCS is turned on, no sound will be heard until signals containing the set tone frequency or DCS code corresponding to the set code are received.
- **Is the external speaker connected?**  
Properly connect a speaker with an impedance of 4 to 16Ω.
- **Is the Bluetooth® headset in use?**  
Turn OFF the power of the Bluetooth® headset, or turn OFF the Bluetooth® function in the setup menu.

### **There is no transmission**

---

- **Is the PTT button pressed properly?**
- **Is the microphone connected correctly?**  
Plug the connector all the way into the MIC jack.
- **Is the transmit frequency set to the amateur band?**  
Transmission outside the amateur band is not possible.
- **Is the antenna or co-axial cable broken?**  
Replace the antenna or co-axial cable.
- **Is the voltage of the external power supply normal?**  
When the voltage of the power supply drops during transmission, the transceiver may not run at full performance. Use a stable DC power supply with a voltage of 13.8V and a current capacity of 15A.

### **The keys or knobs do not operate**

---

- **Is the lock function activated?**  
Cancel the lock by briefly pressing the Power switch.

# ***YAESU***

***Radio for Professionals***

Copyright 2024  
YAESU MUSEN CO., LTD.  
All rights reserved.

No portion of this manual may be  
reproduced without the permission of  
YAESU MUSEN CO., LTD.

**YAESU MUSEN CO., LTD.**

Omori Bellport Building D-3F  
6-26-3 Minami-Oi, Shinagawa-ku, Tokyo, 140-0013, Japan

**YAESU USA**

6125 Phyllis Drive, Cypress, CA 90630, U.S.A.

**YAESU UK**

Unit 4, Concorde Park, Concorde Way, Segensworth North,  
Fareham, Hampshire PO15 5FG, United Kingdom