

YAESU

Radio for Professionals

VHF/UHF DUAL BAND FM TRANSCEIVER

FTM-150R

FTM-150E

Operating Manual

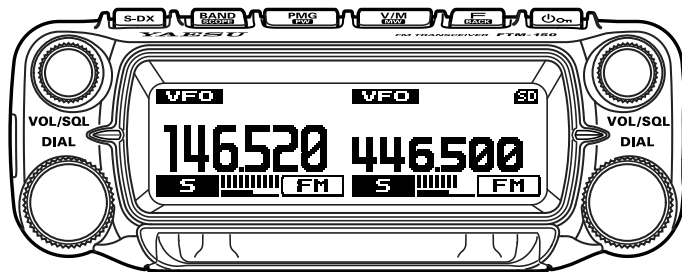

Contents

Introduction	1	Mounting and Dismounting	
Quick Guide	2	microSD Memory Card.....	32
Supplied Accessories and Options	3	Formatting a Micro SD Memory Card	32
About this manual	3	Functions to use as needed	33
Basic Operation	4	Changing the Transmit Power Level	33
Turning the Transceiver ON	4	Setting the Skip Band.....	33
Adjusting the volume	4	Changing the Frequency Step.....	34
Adjusting the squelch level.....	4	Change the display color.....	34
Selecting a Frequency Band	5	MONO Band Display	34
Tuning to a Frequency.....	6	Repeater Operation	35
Switch between Main Band and Sub Band...7		Communicating Via the Repeater	35
Transmitting	7	Using the Memory	36
Locking the Keys and DIAL knob	7	Writing to memory	36
Useful Functions	8	Recall memory (There are three ways).....	37
CFL: Custom Function List	8	Copy memory channel information to VFO.39	
PMG (Primary Memory Group)	9	Recall only memories in the same	
Band Scope	10	frequency band (Band) using the memory	
Memory auto grouping (MAG) function	10	auto grouping (MAG) function	40
VFO Band skip function	10	Registering frequently used memory	
Memory channel → VFO copy	10	channels in M-GRP (Memory Group).....	41
Setup Menu List.....	11	Edit memory	42
Switch between Dual receive and Scope		Recalling the Home Channels.....	44
operation with one touch	12	Changing the Home Channel Frequency...44	
Scope Screen	12	Split Memory	45
Change the number of channels		Scanning Function	46
displayed during scope operation	12	VFO Scan / Memory Scan	46
Select the signal bar on the scope to		Setting the Receive Operation	
hear the audio.....	13	When Scanning Stops.....	46
PMG (Primary Memory Group)	14	Skip Memory Channels	47
Change feature settings	16	Programmable Memory scan (PMS).....	47
Setting functions using the function list	16	Convenience Features	48
Setting functions using the Set up Menu	16	Bluetooth® Operation	
Swapping functions in the function list.....	17	(Requires optional BU-5).....	48
Registration to the Function List.....	17	VOX Operation	53
Cancel registration in the Function List.....	17	Dual Receive Function	54
Super DX plus Noise Cancelling	18	Using the Voice Recorder	55
Name and function of each component	19	Voice announcement of the	
Control Head (front).....	19	operating frequency.....	58
Control Head (top).....	20	Weather Broadcast Reception	59
Control Head (Left and right side).....	21	Tone squelch feature	59
Control Head (rear).....	21	Digital Code squelch (DCS) feature.....	59
Main body (Front)	22	New PAGER (EPCS) feature.....	59
Main body (rear)	22	Using Setup Menu	60
Microphone (SSM-85D)	23	Tables of Setup Menu Operations	61
Display	25	Restoring to Defaults (Reset)	64
Descriptions of Main Screens	27	All Reset	64
Safety Precautions (Be Sure to Read)	28	Memory Channels Reset.....	64
Installing the Radio	30	Text input screen	65
About the antenna.....	30	Specifications	66
Connection of Antenna and Power Cables..30		YAESU LIMITED WARRANTY	68
Installing the Transceiver/Microphone	31		
Install the main body using the			
supplied bracket	31		
Using a Micro SD Memory Card	32		
Usable microSD Memory Cards	32		

Features of the Yaesu FTM-150R/E Transceiver.

- Equipped with a front speaker. The main body speaker, in combination the front panel speaker, provides clear audio quality.
- Total audio output is 6W (3W: main body, 3W: control head) High sound quality, loud speakers.
- The Primary Memory Group Activity Monitor (PMG) function can register up to 5 channels with the receive frequencies of the VFO or memory channels by simply pressing and holding the  key. The AUTO mode simultaneously shows up to two channels when signals are received. Transmit is automatically moved to the received channel. In the MANUAL mode, transmit and receive stays on the manually selected channel. The signal received on the other channel is shown on the screen and the audio can be heard.
- The new Super DX function increases the sensitivity of the RF amplifier when the received signal is weak, and expands the communication range.
- Installing the Audio Digital Signal Processing Unit “SPU-1”, permits digitally processing the received audio signal to separate and remove noise. The voice can be enhanced to produce clear, comfortable, audio quality. Even weak signals that were previously inaudible due to noise can now be received clearly.
- The Custom Function List (CFL) can be personalized by registering frequently used functions (up to 8) from the 62 items Setup Menu.
- Memory Channel Band Auto Grouping (MAG). The memory channels are automatically categorized in each band, so that memory channels can be easily and quickly recalled.
- Simultaneous reception of two separate frequencies, on different bands, or within the same band (V+V/U+U/V+U/U+V).
- VFO band skip function can be set to hide the unused bands.
- High-resolution band scope that displays 47 channels
- Wide-band reception (108MHz to 550MHz)
- Installation of the optional Bluetooth® BU-5 unit permits hands-free communication using the optional Bluetooth® headset SSM-BT20 or a commercially available product.
- Large-capacity 1103 memory channels
- Heavy Duty-Heat Sink with FACC (Funnel Air-Convection Conductor)
- Compatible with microSD memory cards

Thank you for purchasing the FTM-150R/E Transceiver. We urge you to read this manual in its entirety, and also the Advance Manual (available for download on the Yaesu website), to gain a full understanding of the amazing capability of the exciting new FTM-150R/E Transceiver.

Quick Guide

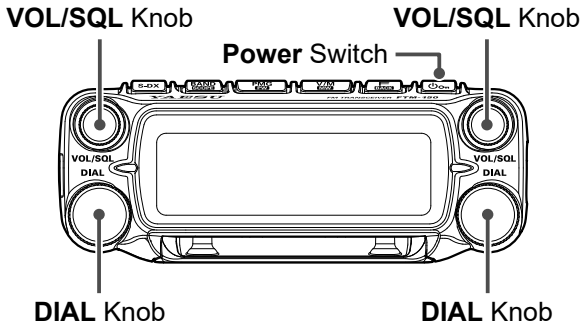

① Turn the Power ON

Press and hold the  key.

② Switch the operating band

Each time the Left or Right **DIAL** knob is pressed, the operating band switches between “Left” and “Right”.

③ Select the Operating Band

Press the  key.

④ Tune the frequency

Rotate the **DIAL** knob.

⑤ Adjust the volume

Rotate the **VOL/SQL** knob to adjust the volume to a comfortable level.

⑥ Adjust the squelch setting

The squelch level may be adjusted to mute the background noise when no signal is received.

1. Press the **VOL/SQL** knob.
2. Rotate the **VOL/SQL** knob to adjust the squelch to a level at which the background noise is muted.

*When the squelch level is increased, the noise is more likely to be silenced, but it may become more difficult to receive weak signals.

3. Press the **VOL/SQL** knob again or wait for about 3 seconds to complete the adjustment.

⑦ Transmit/Receive Signals

Talk into the microphone while holding the **PTT** switch on the side. Release the **PTT** switch to return to receive.

Set the Bluetooth® function

To use a Bluetooth headset, refer to “**Bluetooth® Operation**” on page 48 for setting.

Supplied Accessories and Options

Supplied Accessories

- DTMF microphone SSM-85D
- DC power cable (with fuse attached)
- Bracket for main body
- Spare fuse (15A)
- Operating Manual (This Manual)



If any item is missing, contact the dealer from which you purchased the transceiver.

Available Options

- | | |
|--|----------|
| • Swing Head Kit | SJMK-500 |
| • Dash Mount Bracket | MMB-103 |
| • Control Cable 20ft (6m) | CT-132 |
| • Control Cable 10ft (3m) | SCU-62 |
| • Mic Extension Kit 10ft (3m) for SSM-85D and MH-42C6J | MEK-5 |
| • Voice Guide Unit | FVS-2 |
| • DTMF Microphone | SSM-85D |
| • Microphone | MH-42C6J |
| • Bluetooth® Headset | SSM-BT20 |
| • Bluetooth® Unit | BU-5 |
| • High-Power External Speaker | MLS-100 |

About this manual

The following notation is also used in this manual.



This icon indicates cautions and information that should be read.



This icon indicates notes, tips and information that should be read.

PLEASE NOTE: Due to product improvements, some of the illustrations in the instruction manual may differ from the actual product.

Basic Operation

Turning the Transceiver ON

1. Press and hold the  switch to turn the transceiver **ON / OFF**.

Press and hold 

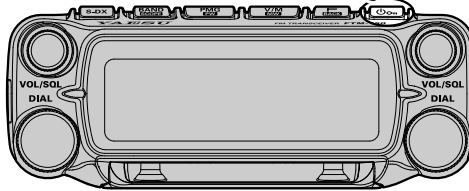

Adjusting the volume

1. Rotate the **VOL** knob to adjust the volume to a comfortable level.

Adjust the volume level
for Left Side Band

Adjust the volume level
for Right Side Band

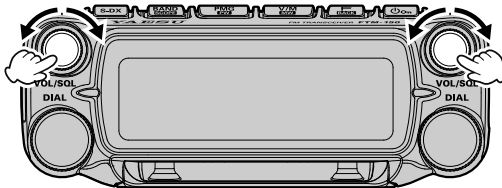

Adjusting the squelch level

Annoying noises can be muted when a signal cannot be detected. Normally, use the factory settings, but adjust the squelch to mute noise or hash.

1. Press the **VOL/SQL** knob, and then rotate the **VOL/SQL** knob to adjust to a level at which the background noise is muted.

Adjust the squelch level
for Left Side Band

Adjust the squelch level
for Right Side Band

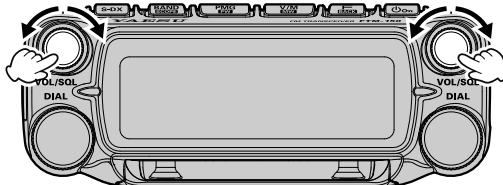

- **SQL** appears on the display.
 - Adjustment is possible for Main band and Sub band.
2. After the adjustment, press the **VOL/SQL** knob again, or do nothing for about 3 seconds, the SQL meter will return to the VOL meter.

 When the squelch level is increased, the noise is more likely to be silenced, but it may become more difficult to receive weak signals.

Selecting a Frequency Band

Press the **BAND RECALL** key to select the desired frequency band.

AIR Band	108MHz - 137MHz
144MHz/VHF Band	137MHz - 174MHz
VHF/UHF Band	174MHz - 400MHz
430MHz/UHF Band	400MHz - 550MHz

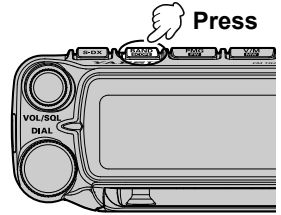

- With the “band skip function”, specific bands may be selected to be used. Even when the band skip is set so that some frequencies cannot be selected, frequently used frequencies can be recalled by saving them into the memory channels before setting band skip.
- Press and hold the **BAND RECALL** key → Rotate the Right **DIAL** knob to select **[20 BAND SKIP]** → Press the Right **DIAL** knob → Rotate the Right **DIAL** knob to select the band to set → Press the Right **DIAL** knob → Rotate the Right **DIAL** knob to select “ON” (selectable) or “OFF” (not selectable)



Tuning to a Frequency

1. Press the **BAND** key to select the desired frequency band.
2. Rotate the **DIAL** knob to select the desired frequency.

AIR Band 108MHz - 137MHz
 144MHz/VHF Band 137MHz - 174MHz
 VHF/UHF Band 174MHz - 400MHz
 430MHz/UHF Band 400MHz - 550MHz

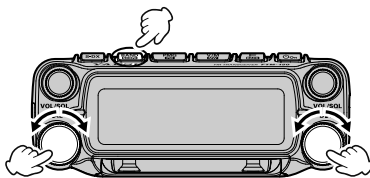

● Keyboard frequency entry (Direct Input)

1. Press the **KEYPAD** key, to display the function list screen.
2. Rotate the Right **DIAL** knob to select **[KEYPAD]** then press the Right **DIAL** knob. Display the frequency input screen.
3. The leftmost digit will blink, then turn the Right **DIAL** knob to select the first digit.
4. Press the Right **DIAL** knob, the second digit will blink.
5. Rotate the Right **DIAL** knob to select the second digit.
6. Repeat the same operation to select additional digits. Then press and hold the Right **DIAL** knob to conclude the input and confirm the frequency.

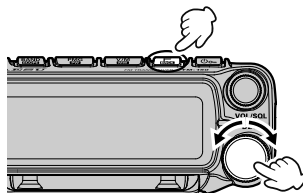

M->V	KEYPAD	TX PWR
RPT REV	RPT ARS	

FREQUENCY				
1	2	3	4	5
6	7	8	9	0
MEM CH		MEM LIST		↵

i While entering a frequency using the keyboard, the entry may be canceled by pressing the **KEYPAD** key.

● Change the frequency rapidly (MHz up/down function)

Press and hold the **DIAL** knob, to blink the MHz digit.
 Change the frequency in 1MHz steps by turning the **DIAL** knob while it is blinking.

i In this case, change the frequency within the range of 108MHz to 550MHz regardless of the band. Operation will be within the band that includes the input frequency.

See below for details on operating bands.

108MHz - 137MHz → AM mode
 137MHz - 300MHz → FM mode
 300MHz - 320MHz (for USA: 336MHz) → AM mode
 320MHz (for USA: 336MHz) - 550MHz → FM mode

Change to AM or FM mode in the Set Menu **[13 RX MODE]**.

● The numeric keys on microphone

Press the numeric keys “0” to “9” to enter the frequency.

Example: To input 145.525MHz

[1] → [4] → [5] → [5] → [2]

Example: To input 430.000MHz

[4] → [3] → [Press and hold any numeric key]



While entering a frequency using the numeric keys, the entry may be canceled by pressing **PTT**.



Switch between Main Band and Sub Band

The two operational bands are displayed on the left and right of the display. The large numbers indicate which band can transmit.

Each time the Left or Right **DIAL** knob is pressed, the operating band switches between “Left” and “Right”.

The band displayed with large numbers is called the “Main Band”. The band that is indicated in small numbers is the “Sub Band”.

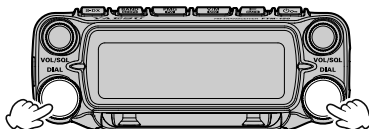

Transmitting

1. While pressing and holding **PTT**, speak into the microphone.
2. Release the PTT to return to receive.



Press the microphone [P1] key (factory default) to transmit on the Sub Band frequency.



- If the **PTT** switch is pressed when a frequency other than the amateur ham radio band is selected, an alarm tone (beep) will be emitted, “**TX PROHIBIT**” appears on the display, and transmit is disabled.

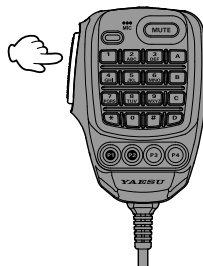

- If transmission is continued for a long period, the transceiver overheats, and the high temperature protection function is activated. As a result, the transmitting power level is automatically set to Low Power. If transmission continues while the high temperature protection function is active, the transceiver will be forcibly returned to the receive mode.



Locking the Keys and DIAL knob

1. Press the  switch, “**LOCK**” is shown on the display for one second, the “” icon appears on the display, and then the keys and **DIAL** knob are locked.
2. Press the  switch again, “**UNLOCK**” will be shown on the Display and the keys and the **DIAL** knob are unlocked.

The “” icon disappears.



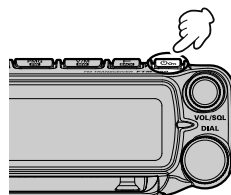

The **PTT** switch and the VOL/SQL knob cannot be locked.





Useful Functions

① CFL: Custom Function List page 16

From 62 items of the Setup Menu, frequently used functions in the Function List can be registered and then recalled by simply pressing the  key. The Function List screen displays the registered functions and current settings in an easy-to-read form, so you can immediately select and use the function. By default, 9 functions are registered in the Custom Function List. Up to 8 frequently used functions can be registered and customized in the Function List.

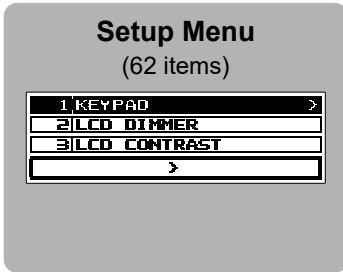
Press and hold the  key



Press and hold the  key
↓
Press and hold the  key



to register

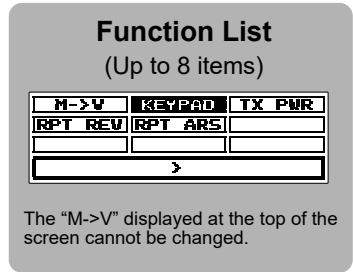

Press the  key



● Registration to the Custom Function List

Press and hold the  key to display the setup menu, select the item to be registered with the Right **DIAL** knob, then press and hold the  key.

Select the list position to register the setup item with the Right **DIAL** knob, and then press and hold the  key to register it in the setup menu.

● Use the Function List

Press the  key to display the function list screen, and select the function to be used with the Right **DIAL** knob.

By pressing the Right **DIAL** knob, you can execute functions or change settings.

● Cancel registration to Function List

On the function list screen, select the function to cancel with the Right **DIAL** knob.

Press and hold the  key to cancel the registration.

Press and hold: to register in the function list

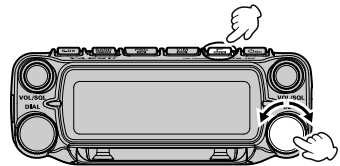

Turn the Right **DIAL** knob to select, then press and hold the  key

Press: to recall

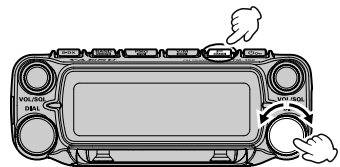

Turn the Right **DIAL** knob to select, then press the Right **DIAL** knob

Press and hold: to cancel registration

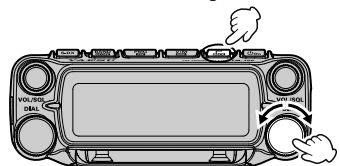



② **PMG (Primary Memory Group)** **page 14**

The PMG function allows registration of up to five often used frequencies for easy monitoring. Simply press and hold the  key to register the currently displayed VFO or Memory Channel frequency. The PMG screen can be switched to auto mode or manual mode by pressing and holding the Right **DIAL** knob.

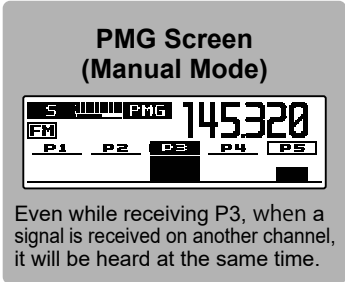
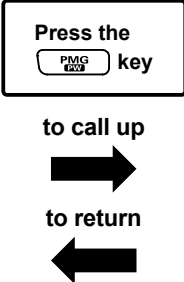
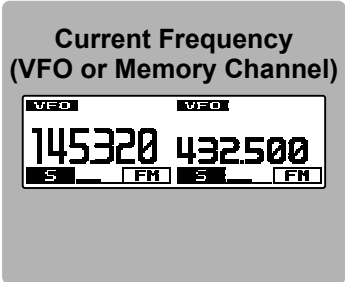
In manual mode, while receiving the channel selected with the DIAL knob, other channels are also scanned and a channel with a signal is simultaneously heard.





- **Register the frequency to PMG**
Display the frequency of the VFO or memory channel, then press and hold the  key. The frequency is registered in PMG.
- **Display the PMG screen**
Press the  key to display the PMG screen.

Press and hold the Right **DIAL** knob to switch between Manual Mode and Auto Mode.

Manual Mode:
While receiving the channel selected with the **DIAL** knob, other channels are also scanned and a channel with a signal is heard at the same time.
Transmission is fixed to the channel selected with the **DIAL** knob.

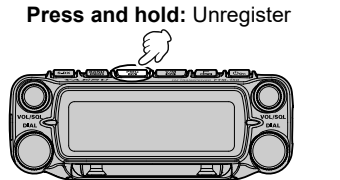
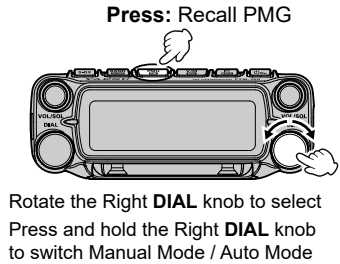
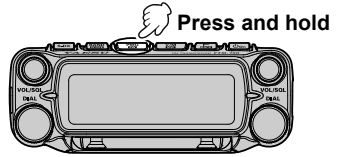
Auto Mode:
The PMG channels are scanned and up to two channels with signals are simultaneously received. When a signal disappears, scanning resumes and up to two channels are always heard at the same time.
Transmission is automatically performed on the channel that received the signal.



- **Cancel the frequency registered in PMG**
Select a channel on the PMG screen and press and hold the  key.

③ Band Scope page 12

The receive status (signal strength) of the channels above and below the current frequency can be displayed as a bar graph, whether in VFO mode or in memory mode.

Press and hold the **[BAND SCOPE]** key to display the band scope screen. When the desired channel is set to the center with the **DIAL** knob, the received audio is played.

Press and hold: Displays the band scope

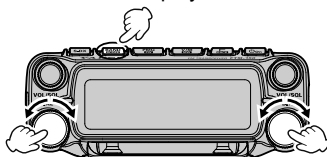

Rotate the **DIAL** knob to select the channel

④ Memory auto grouping (MAG) function page 40

Memory channels can be automatically grouped and recalled for each band.

Press the **[BAND GROUP]** key in memory mode.

In the memory mode, each time the **[BAND GROUP]** key is pressed, only memory channels of the specified frequency band are automatically recalled as a group, as shown below:

Press: Select the band to display in memory mode

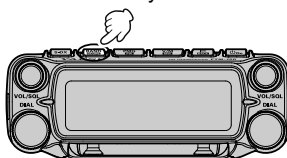

⑤ VFO Band skip function page 33

Bands that are not normally used can be skipped when the **[BAND SKIP]** key is pressed.

In VFO mode, press and hold the **[BAND SKIP]** key, select the desired band with the Right **DIAL** knob, and press the Right **DIAL** knob.

Then turn the Right **DIAL** knob to set "ON" (selectable) or "OFF" (not selectable).

All Memory Channels may still be recalled except a frequency that is saved in the band set to be skipped.

Press and hold: Select [20 BAND SKIP]

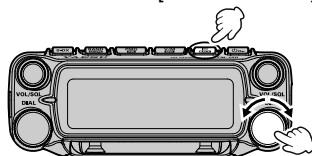

Turn the Right **DIAL** to select a band then select ON/OFF

⑥ Memory channel → VFO copy page 39

Transfers the recalled memory channel to the VFO with one-touch operation.

Press and hold the **[BAND GROUP]** key while recalling a memory channel to transfer the memory channel information to the VFO and switch to VFO mode.

Press

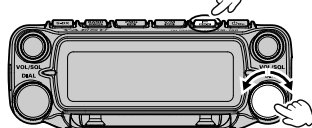

Select [M->V]
Press the Right **DIAL** knob

Setup Menu List

Frequently used items from the below 62 Setup Menu types, can be registered to the Function List. (See page 16) The gray Setting items are registered in the Function List by factory default. See page 60 for detail information on the Setup Menu.

DISPLAY
1 KEYPAD
2 LCD DIMMER
3 LCD CONTRAST
4 BAND SCOPE
5 S-METER SYMBOL
6 BACKLIGHT COLOR

TX
7 TX POWER
8 MIC GAIN
9 VOX
10 AUTO DIALER
11 TOT

RX
12 FM BANDWIDTH
13 RX MODE
14 SUB BAND

MEMORY
15 HOME CH
16 MEMORY LIST
17 MEMORY LIST MODE
18 PMG

CONFIG
19 BEEP
20 BAND SKIP
21 RPT ARS
22 RPT SHIFT
23 RPT SHIFT FREQ
24 RPT REVERSE
25 MIC PROGRAM KEY
26 STEP
27 CLOCK TYPE
28 APO

AUDIO
29 REAR SP OUT
30 FRONT SP MUTE

SIGNALING
31 DTMF
32 DTMF MEMORY
33 SQL TYPE
34 TONE SQL FREQ(DCS CODE)
35 SQL EXPANSION
36 PAGER CODE
37 PR FREQUENCY
38 BELL RINGER
39 WX ALERT

SCAN
40 SCAN
41 DUAL RECEIVE MODE
42 DUAL RX INTERVAL
43 PRIORITY REVERT
44 SCAN RESUME

DATA
45 DATA BAND
46 DATA SPEED

SD CARD
47 BACKUP
48 SD INFORMATION
49 SD FORMAT

OPTION
50 Bluetooth
51 VOICE MEMORY
52 FVS REC
53 TRACK SELECT
54 FVS PLAY
55 FVS STOP
56 FVS CLEAR
57 VOICE GUIDE

CLONE/RESET
58 This → Other
59 Other → This
60 SOFTWARE VERSION
61 MEMORY CH RESET
62 FACTORY RESET

Switch between Dual receive and Scope operation with one touch

Dual receive and Scope operations are switched each time the  key is pressed and held.

The center frequency or memory channel can be changed by turning the Left **DIAL** knob:

In VFO Mode, press and hold the Right **DIAL** knob, then turn the Right **DIAL** knob to select the frequency in 1MHz increments.

In Memory Mode, press and hold the Right **DIAL** knob, then turn the Right **DIAL** knob to select in 10 channel steps.

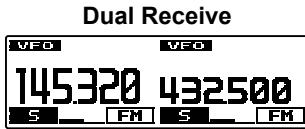

Press and hold the  key

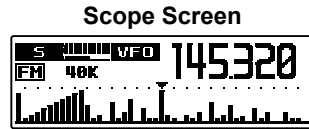

Scope Screen

The interval between dots indicating the channel step (40 kHz in this case)

The interval between dots indicating the channel step (Is not displayed in memory mode)





Marker position of the receive frequency

- In scope operation, the marker frequency is received while other frequencies are monitored and a bar graph is displayed.
- Transmission is also performed at the frequency of the marker position.

The status (strengths) of the signals in the upper and lower frequency channels (47CH or 23CH), or memory channels (23CH or 13CH) are displayed on the Scope Bar graph, centered on the current operating channel.

Change the number of channels displayed during scope operation

1. Press and hold the  key.
2. Rotate the Right **DIAL** knob to select [**4 BAND SCOPE**].
3. Press the Right **DIAL** knob.
4. Rotate the Right **DIAL** knob to select "**WIDE**" or "**NARROW**".
5. Press any key or **DIAL** knob, other than the  or  key, to save the settings and return to normal operation.

	VFO Mode	Memory Mode
WIDE	47 channels	23 channels
NARROW	23 channels	13 channels

Select the signal bar on the scope to hear the audio

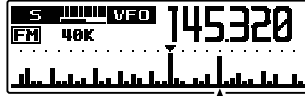

Receiving this signal

- The left **DIAL** knob moves the bar without moving the marker.
- Receive the desired signal to hear by aligning the bar with the center marker.

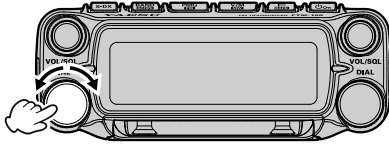

Rotate the Left DIAL knob

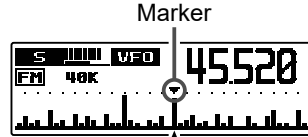

Align the bar of the signal you want to hear with the center marker.

- The right **DIAL** knob moves the marker without moving the bar.
- Receive the signal you want to hear by aligning the marker with the bar.

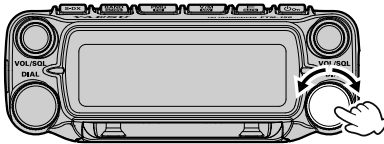

Rotate the Right DIAL knob

Align the marker on the bar of the signal you want to hear



PMG (Primary Memory Group)

The PMG function scans up to 5 channels registered to the PMG. The receive status of each channel is simultaneously displayed in real time with a bar graph. In addition, two channels with signals are simultaneously received, allowing convenient standby. In manual mode, transmit and receive are fixed to the selected channel, and signals are received simultaneously on other channels. In auto mode, other channels are scanned while receiving on the selected channel, and up to two channels with signals are received simultaneously. Transmission is automatically performed on the receiving channel. To register the currently displayed VFO or memory channel to the PMG, simply press and hold the  key on the frequency.



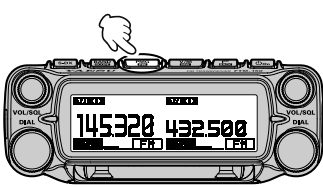

PMG Screen

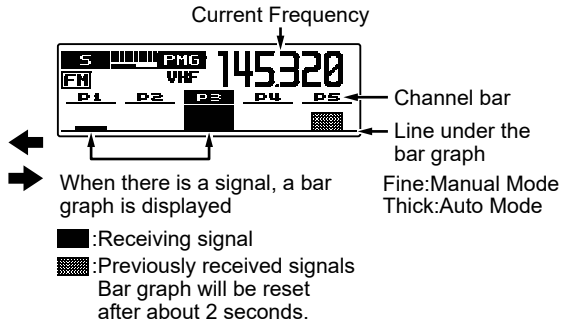

Press the  key

When the PMG function is active, the  key illumination changes to amber.



- If there are no registered Channels in PMG, the PMG screen will not be displayed even if the  key is pressed.
- To adjust the volume and squelch while PMG is operating, use the Right VOL/SQL knob.
- Press and hold the  key to cancel the registration of the currently selected PMG channel.
- Press the  key to return to the screen displayed before the PMG screen.
- Press and hold the  key on the PMG screen to copy the contents of the currently selected PMG channel to the VFO, and enter VFO mode.

Register the frequency to PMG

Press and hold the  key to register the current frequency in PMG. PMG channels are registered in order from P1 to P5.

- Up to 5 channels can be registered in PMG. When registering more than five Frequencies, older frequencies will be deleted in order from PMG.
- Cannot register a frequency that is already registered.

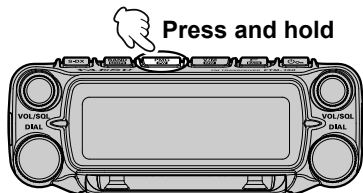

Unregister the Channel (Frequency) registered in PMG

1. Select the channel to be unregistered by rotating the Right DIAL knob.
2. Press and hold the  key to cancel the registration.

On the PMG screen, rotate the Right **DIAL** knob to select the channel to be heard. The channel number display will be inverted to indicate the received channel.



Press and hold the Right **DIAL** knob Switch between **Manual Mode** and **Auto Mode**.

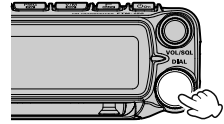

Press and hold

MANUAL Mode

While continuously receiving on the PMG channel selected with the DIAL knob. Other PMG channels are simultaneously scanned, and received signals are heard. Transmission is on the selected channel (displayed in inverse image).

When a signal is received on another channel, the signal strength is displayed as a bar graph and it is simultaneously heard, but the transmit channel does not change. Turn the **DIAL** knob to change the transmit channel.

Turn the DIAL knob to select the desired channel (e.g. P2).



Receive a signal on P2.
Scan P1, P3 to P5.

Receive a signal on P2



While listening to received audio on P2, scanning will continue on P1, P3 to P5.

Receive a signal other than P2 (e.g. P5)



Display as a bar graph. Scan will stop. P2 and P5 received audio can be heard at the same time. Transmission is on P2.

When the P5 signal disappears.

While listening to received audio on P2, scanning will continue on P1, P3 to P5.



The volume of P2 can be adjusted with the right VOL/SQL knob, and the audio of other channels can be adjusted with the left VOL/SQL knob.

AUTO Mode

While receiving the PMG channel selected with the **DIAL** knob, scan continues on the other PMG channels and up to two channels with signals are simultaneously received. When a signal disappears, scanning resumes.

Transmission is automatically performed on the channel that received the signal.



Receive a signal on P2.
Scan P1, P3 to P5.

Receive a signal on P3



The channel will automatically change to P3 and while listening to received audio on P3, scanning will continue on P1, P2, P4 and P5. Transmit will also be set to this channel.

Receive a signal on P5



P3 and P5 received audio can be heard at the same time. Scan will stop.

The volume of P3 can be adjusted with the right VOL/SQL knob, and the audio of other channels can be adjusted with the left VOL/SQL knob.

Change feature settings

Setting functions using the function list

1. Press the **[F LIST]** key.
The Function List is displayed.
2. Rotate the Right **DIAL** knob to select the desired function.
3. Press the Right **DIAL** knob to execute functions or change settings.

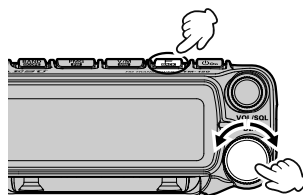

Close the function List

Press any key or **DIAL** knob, other than the **[F LIST]** or **[POWER]** key, to save the settings and return to normal operation.



The functions in the Function List are set as shown in the screen illustration on the right when shipped from the factory. To change the settings, refer to the instructions on the next page.

M → V	KEYPAD	TX PWR
RPT REV	RPT ARS	

Setting functions using the Set up Menu

1. Press and hold the **[F LIST]** key.
The Setup Menu screen is displayed.
2. Rotate the Right **DIAL** knob to select the desired function (see table below).
3. Press the Right **DIAL** knob to execute functions or change settings.

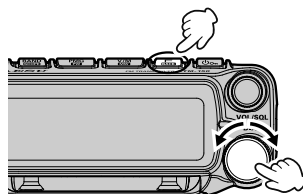

Close the Set-Up Menu

Press any key or **DIAL** knob, other than the **[F LIST]** or **[POWER]** key, to save the settings and return to normal operation.

Set Up Menu List

1 KEYPAD
2 LCD DIMMER
3 LCD CONTRAST
4 BAND SCOPE
5 S-METER SYMBOL
6 BACKLIGHT COLOR
7 TX POWER
8 MIC GAIN
9 VOX
10 AUTO DIALER
11 TOT
12 FM BANDWIDTH
13 RX MODE
14 SUB BAND
15 HOME CH
16 MEMORY LIST
17 MEMORY LIST MODE
18 PMG
19 BEEP
20 BAND SKIP
21 RPT ARS

22 RPT SHIFT
23 RPT SHIFT FREQ
24 RPT REVERSE
25 MIC PROGRAM KEY
26 STEP
27 CLOCK TYPE
28 APO
29 REAR SP OUT
30 FRONT SP MUTE
31 DTMF
32 DTMF MEMORY
33 SQL TYPE
34 TONE SQL FREQ (DCS CODE)
35 SQL EXPANSION
36 PAGER CODE
37 PR FREQUENCY
38 BELL RINGER
39 WX ALERT
40 SCAN
41 DUAL RECEIVE MODE

42 DUAL RX INTERVAL
43 PRIORITY REVERT
44 SCAN RESUME
45 DATA BAND
46 DATA SPEED
47 BACKUP
48 SD INFORMATION
49 SD FORMAT
50 Bluetooth
51 VOICE MEMORY
52 FVS REC
53 TRACK SELECT
54 FVS PLAY
55 FVS STOP
56 FVS CLEAR
57 VOICE GUIDE
58 This → Other
59 Other → This
60 SOFTWARE VERSION
61 MEMORY CH RESET
62 FACTORY RESET

The gray Setting item are registered in the Function List by factory default.

Swapping functions in the function list

Easily operate frequently used functions by calling them from the function list with one-touch operation of the  key. The list of registered priority functions and the setting status can be viewed at a glance. Change the function or change the setting just by selecting and pressing with the **DIAL** knob. The following 4 functions are registered in the function list by factory default. However, up to 8 frequently used functions from 62 setup menu types can be registered (see previous page).

Press the  key briefly to recall the function list

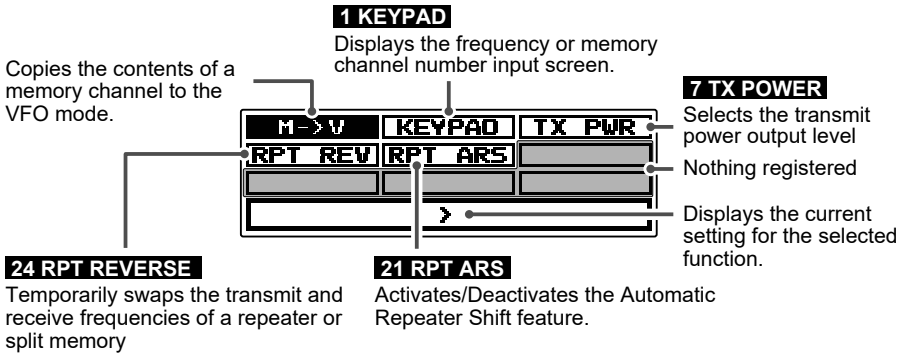

Function List display example (factory default setting)



- The "M -> V" displayed at the top of the screen cannot be changed.
- Up to 8 items can be registered in the Function List.



Changing the contents of the function list

Registration to the Function List

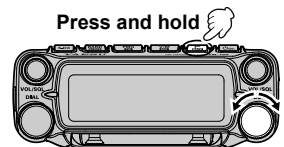
1. Press and hold the  key.
2. Rotate the Right **DIAL** knob to select the item to be registered in the Function List.
3. Press and hold the  key.
The Function List screen appears.
4. Rotate the Right **DIAL** knob to select the location to register.
5. Press and hold the  key.
The function is registered in the selected location.



Cancel registration in the Function List

1. Press the  key.
2. Rotate the Right **DIAL** knob to select the registered item to cancel.
3. Press and hold the  key.
The confirmation screen will be displayed.
4. Rotate the Right **DIAL** knob to select **[OK]** and press the Right **DIAL** knob.

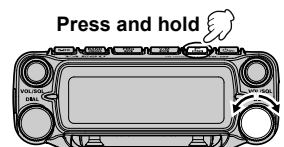

Super DX plus Noise Cancelling

The Super DX function increases the sensitivity of the RF amplifier when the received signal is weak, expanding the calling range. In addition, by installing the Audio Digital Signal Processing Unit “SPU-1”, the received audio signal can be digitally processed to separate and remove noise. The voice can be enhanced to produce clearer, more comfortable sound quality. Even weak signals that were previously inaudible due to noise can now be received clearly.

Press the **[S-DX]** key to activate the Super DX function, the **[S]** changes to **[S-DX]** on the display. When the SPU-1 is installed, the **[S-DX]** key also turns the “Noise Cancelling” function ON, the **[S]** changes to **[ASP]** on the display.

Press the **[S-DX]** key again to return the receiver to normal sensitivity. The **[S-DX]** or **[ASP]** changes to **[S]**.

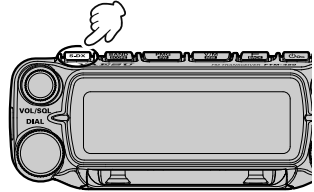

Display when Super DX function is activated



Super DX function and Noise Cancelling functions are activated



Installing the Audio Digital Signal Processing Unit “SPU-1”

1. Turn the transceiver OFF.
2. Disconnect all the cables and the microphone from the transceiver.
3. Remove the 8 screws from the main body, 4 on top and 2 each at the sides.
4. Carefully lift the top cover of the main body.
5. Unplug the speaker cables extending from the top cover from the socket on the board inside the main body before removing the cover.
6. Refer to the illustration for the mounting location of the SPU-1. Align the triangle marks and plug the SPU-1, all the way into the connector.
7. Fasten the SPU-1 into place using the 2 screws supplied with the SPU-1.



Do not use incorrect screws, only use the supplied screws.

8. Replace the top cover and secure it using the 8 screws.



*Please note that the 2 screws on the front panel side of the top cover are longer than the other 6 screws.

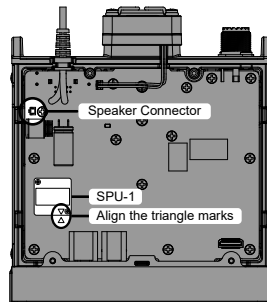
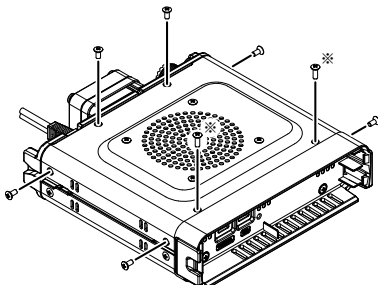

Name and function of each component

Control Head (front)

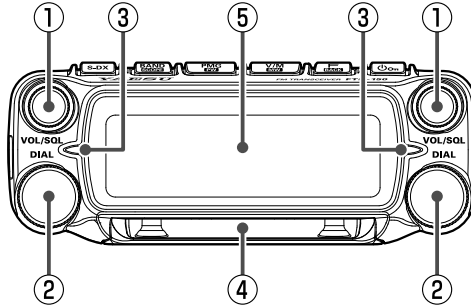

① VOL/SQL knob

Rotate the **VOL/SQL** Knob to adjust the audio volume level.

VOL/SQL knob (Left): Left Side Band

VOL/SQL knob (Right): Right Side Band

Press the **VOL/SQL** knob, then rotate the **VOL/SQL** knob to adjust the squelch level. The squelch level may be adjusted to mute the background noise when no signal is present.

② DIAL knob

Change the frequency or select the memory channel.

DIAL knob (Left): Left Side Band

DIAL knob (Right): Right Side Band

- Each time the Left or Right DIAL knob is pressed, the operating band switches between "Left" and "Right". The band displayed with large numbers is called the "Main Band", and the band that is displayed in small numbers is the "Sub Band".
- In VFO mode, the frequency may be changed in 1MHz increments after pressing the knob.
- In Memory Mode, press and then turn the knob to select in 10 channel steps.

③ Mode indicator

The current operating mode is indicated by the color of the LED.

Green: During receive

Red: During transmit

Green (blinks): while receiving a signal that does not match the DCS/CTCSS tones.

④ Speaker

The 3W high output front speaker at the bottom of the control-head, ensures clear and powerful audio.

⑤ Display

Control Head (top)

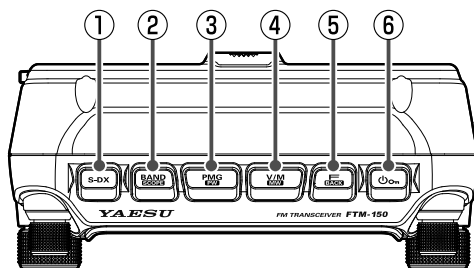

① **S-DX** key

Enables the Super DX function and increases sensitivity. Installation of the “SPU-1”, provides even greater noise reduction and clearer audio.

② **BAND GROUP** key

VFO mode

• Press:

Each key press switches the operating frequency band.

Band	Selectable Frequency Range
AIR	108MHz - 137MHz
144MHz/VHF	137MHz - 174MHz
VHF/UHF	174MHz - 400MHz
430MHz/UHF	400MHz - 550MHz

• Press and hold:

Displays the scope screen with the current frequency as the center and the status of the upper and lower channels (received signal strengths) in a graph.

Press the key again to return to the normal screen.

Memory mode

• Press:

Each time the key is pressed, only memory channels of the same frequency band are automatically recalled in a group as shown below.

- M-ALL** All memory channels
- M-AIR** AIR band memory channels
- M-VHF** 144MHz band memory channel
- M-UHF** 430MHz band memory channel
- OTHER** 174MHz - 400MHz band memory channels
- M-GRP** Channels, regardless of the band, can be registered in advance and called up as frequently used memory channels in the M-GRP.

• Press and hold:

Displays the scope screen with the current memory channel at the center and the received signal strength status of the upper and lower channels in a graph.

③ **PMG** key

• Press:

Displays PMG (Primary Memory Group). (see page 14)

Press and hold the Right **DIAL** knob to switch between auto mode and manual mode.

In manual mode, while receiving the channel selected with the **DIAL** knob, other channels are also scanned and a channel with a signal is heard at the same time. Transmission is fixed to the channel selected with the **DIAL** knob.

In Auto mode, the PMG channels are scanned and up to two channels with signals are simultaneously received. When a signal disappears, scanning resumes and up to two channels are always heard at the same time. Transmission is automatically performed on the channel that received the signal.

Press the key again to cancel PMG mode.

When the PMG function is active, the **PMG** key illumination changes to amber.

• Press and hold:

Register the displayed frequency in PMG.

Press and hold in VFO mode or memory mode to register the current frequency in PMG.

Up to 5 channels can be registered for PMG regardless of the frequency band.

④ **V/M** key

• Press:

Each key press switches between VFO mode and memory mode.

When a memory channel is recalled, the memory channel number is displayed, such as “M-ALL 001”. The last operated memory channel is recalled.

• Press and hold:

Press and hold the key to display the memory channel list screen.

Writing to memory or recalling and editing of stored memory channel.

⑤  **key**

• **Press:**

Display the CFL (Customized Function List) screen. Rotate the Right **DIAL** knob to select an item and perform the functions and make settings.

• **Press and hold:**

To enter set-up menu. The Set Mode permits configuring the various functions according to individual operating needs and preferences. (Refer to page 60).

⑥  **key**

Press and hold this key to switch the power ON or OFF.

When the power is ON, press this key briefly to engage, or release the key lock.

Control Head (Left and right side)

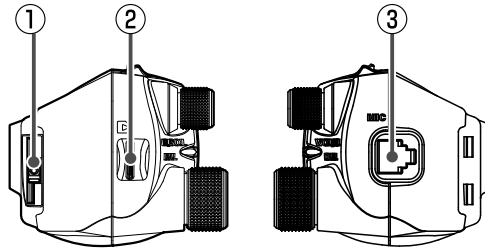

① **Release knob**

Press to release the control panel from the transceiver.

② **micro-SD card slot**

Insert a commercially available micro SD card to backup the various radio settings, memory channels, and update the firmware.

③ **MIC jack**

Control Head (rear)

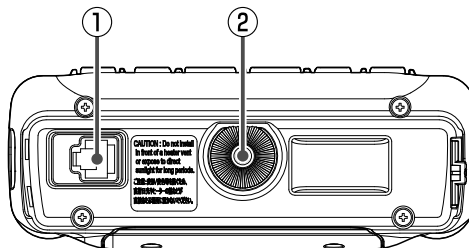

① **CONTROL jack**

Plug in the control cable into this jack to connect with the main body.

② **Screw hole for bracket**

Attach the optional control head bracket.

Main body (Front)

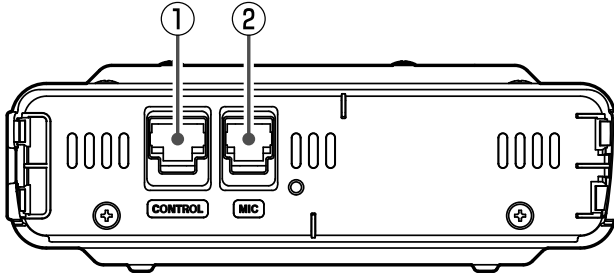

① CONTROL jack

Plug the control cable into this jack to connect with the control panel.

② MIC jack

Connect the cable of the included DTMF microphone SSM-85D or the optional microphone MH-42C6J.

Main body (rear)

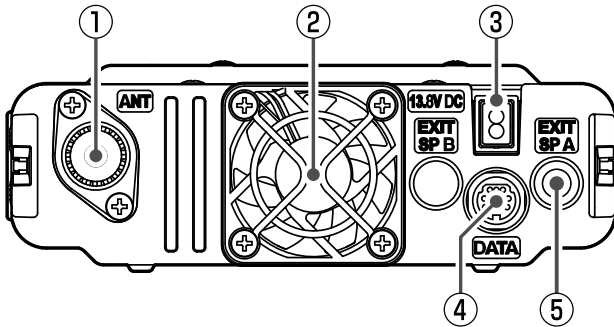

① ANT terminal

Connect the co-axial cable for the antenna.

② Cooling fan

③ 13.8V DC

Connect the provided DC power supply cable (with fuse attached).

④ DATA Jack

Use a Clone cable (CT-166) to connect to another FTM-150R/E. All data stored in one FTM-150R/E can be transferred to another FTM-150R/E by utilizing the handy "Cloning" feature.

Refer to the Advanced Manual which may be downloaded from the Yaesu website.

⑤ EXT SP jack

For the operation when external speakers are connected to jack (3.5mm).

The front speakers will output audio even if an external speaker is connected. To mute front speaker sound, change the setup menu [30 FRONT SP MUTE] to "AUTO MUTE".

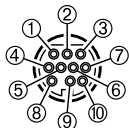

① PKD (packet data input)

② GND

③ PKS (PTT)

④ RX 9600bps (9600 bps packet data output)

⑤ RX 1200bps (1200 bps packet data output)

⑥ PK SQL (squelch control)

⑦ TXD (serial data output [transceiver → PC])

⑧ RXD (serial data input [transceiver ← PC])

⑨ CTS (data communication control)

⑩ RTS (data communication control)

Microphone (SSM-85D)

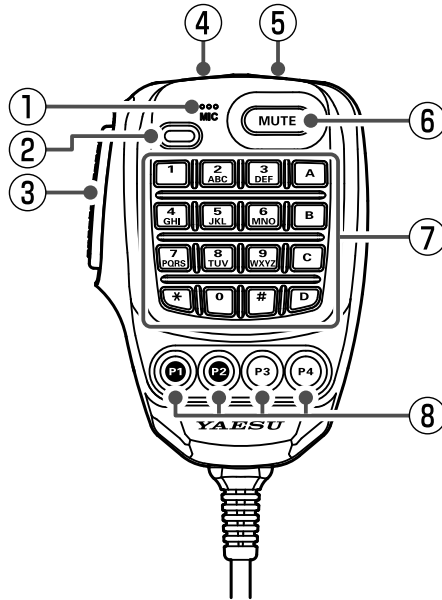

① MIC

Speak into the microphone during transmission.

② TX LED

Lights red while pressing PTT switch.

③ PTT

Press and hold the PTT switch to transmit, and release it to receive.

Press this key during the set mode to exit the set mode.

④ DWN

- Press this key to move the frequency or memory channel lower by one step, press and hold it to start scanning.
- On the memory channel list screen, press to select memory channels in 10 channel steps.
- On the Setup Menu screen, press to jump to the previous category of the Setup Menu.

⑤ UP

- Press this key to move the frequency or memory channel up by one step, press and hold it to start scanning.
- On the memory channel list screen, press to select memory channels in 10 channel steps.
- On the Setup Menu screen, press to jump to the next category of the Setup Menu.

⑥ MUTE

Press this key to mute the receive audio. Press it again to unmute the audio.

⑦ DTMF keypad

Press these keys during transmit to enter and send a DTMF sequence. The following operations can be performed during receive.



DTMF cannot be sent while transmitting using the 2nd PTT (see next page) assigned to a program key (P1/P2/P3/P4).

0 - 9 : Enter the frequency or memory channel number.

A : The operation band switches to Left Side band.

B : The operation band switches to Right Side band.

C : Adjust the squelch level.

D : The band scope function operates.

* : Each press switches between VFO mode and memory mode.

: This key has the same function as the **BAND RECALL** key on the controller.

VFO mode:

Each press changes the operating frequency band.

AIR → 144MHz → VHF → 430MHz

Memory mode:

Each time the key is pressed only memory channels of the same frequency band are automatically recalled as a group, as shown below:

M-ALL → **M-AIR** → **M-VHF** → **M-UHF** → **OTHER** → **M-GRP**

⑧ Program keys (P1/P2/P3/P4)

The default function settings of the [P1] / [P2] / [P3] / [P4] keys are shown in the table below.

Key	Default Settings	Function
P1	2nd PTT	Transmit on the SUB Band frequency (The band displayed with small numbers)
P2	HOME CH	Recalls the HOME channel
P3	TX POWER	Selects the transmit power output level
P4	WX (T-CALL)	Switches operation to the Weather Channel Bank (USA version) Transmits the T-CALL(1750 Hz) (European version)

The functions of the [P1] / [P2] / [P3] / [P4] keys can be assigned by the following operations:

1. Press and hold the  knob.
2. Rotate the Right **DIAL** knob to select **[25 MIC PROGRAM KEY]**, then press the Right **DIAL** knob.
4. Rotate the Right **DIAL** knob to select a key to assign a function **[P1] / [P2] / [P3] / [P4]** then press the Right **DIAL** knob.
5. Rotate the Right **DIAL** knob to select a function (see the table below) then press the Right **DIAL** knob.

Function	Description
OFF	(disable the P key)
2nd PTT	Transmit on the SUB Band frequency (The band displayed with small numbers)
SCAN	Starts or stops the scanning function
HOME CH	Recalls the HOME channel
RPT SHIFT	Sets the repeater shift direction
REVERSE	Reverses the transmit and receive frequencies in repeater mode or split memory.
TX POWER	Selects the transmit power output level
SQL OFF	Opens the squelch (SQL off)
T-CALL	Transmits the T-CALL(1750 Hz)
VOICE	Announces the current frequency (requires optional FVS-2)
WX	Switches operation to the Weather Channel Bank
DW	Operation setting of dual receive function

Display

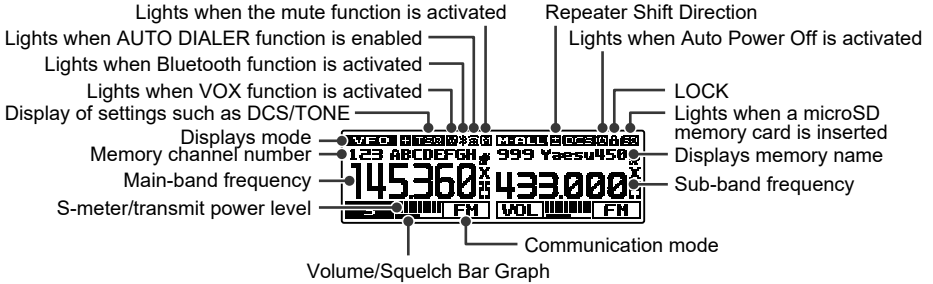

WFO WFO mode

M-ALL Recalls all memory channels regardless of frequency band

M-AIR Recalls only memory channels in the AIR band (108 - 137MHz).

M-VHF Recalls only memory channels in the 144MHz band (137 - 174MHz).

M-UHF Recalls only memory channels in the 430MHz band (400 - 550MHz).

OTHER Recalls only VHF and UHF memory channels (174 - 400MHz).

M-GRP Channels, regardless of the band, can be registered in advance and called up as frequently used memory channels in the M-GRP.

PMG PMG (Primary Memory Group) Function

HOME HOME Channel

PMS Programmable Memory Scan (PMS)



Appears when the lock function is enabled.



Appears when the Mute function for Sub-band is enabled.



Appears when the APO (Automatic Power-Off) function is enabled.



Appears when the DTMF Autodialer function is activated.



Appears when a microSD card is inserted.







Appears when the Bluetooth function is activated.

Appears: Bluetooth device is connected.
Blinks: Bluetooth device not connected.













Appears when the VOX function is enabled.

	Repeater minus (-) shift
	Repeater plus (+) shift
	Split operation
	Skip Memory Channel (Permits designating undesired channels to be skipped during scanning.)
	Bell function is activated.
TN	Tone Encoder (tone frequency is displayed)
TSQ	Tone Squelch (tone frequency is displayed)
RTN	Reverse Tone (tone frequency is displayed)
DCS	DCS (Digital Code Squelch) (DCS code is displayed)
PR	No-communication Squelch
PAG	Pager (EPCS)

The following can be set when the squelch expansion (see page 62) is "ON":

DC	Send the DCS code only during transmission. (DCS code is displayed)
T-D	Send the CTCSS tone signal during transmit, and wait for the DCS code in receive mode. (tone frequency is displayed)
D-T	Send the DCS code during transmit, and wait for the CTCSS tone signal in receive mode. (tone frequency is displayed)

	FM Mode
	AM Mode
	S meter (Displays received signal strength in 10 levels)
	
	PO meter (Displays transmit output in 3 levels when transmitting)
	
	Volume level
	SQL level
	Super DX function
	Super DX function (with SPU-1 installed)

Descriptions of Main Screens

● Normal screen (VFO screen)



Main-band and Sub-band are displayed in a Left-Right fashion.

Both bands are received simultaneously.

● Mono Band screen (VFO screen)



Mono-band operation

Only one band is displayed large.

*Simultaneous reception is not possible when using mono band.

● PMG screen

Press the  key to display the PMG (Primary Memory Group) screen.

The PMG function, which displays the receive status of the registered channels in a bar graph, can register up to 5 channels by simply pressing and holding the  key for the current display frequency, either of the VFO or the memory channel.



• The PMG screen auto mode and manual mode can be switched by pressing and holding the Right **DIAL** knob.

• Press and hold the  key to switch the operating channel.

● Band Scope screen

Press and hold the  key to display the Band Scope screen.

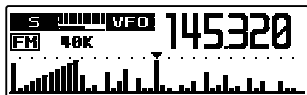

The strengths of received signals above and below the current frequency or memory channel are shown in a graph while scanning at high speed. The audio of the center frequency is heard without interruption.



• Rotate the **DIAL** knob to change the frequency or memory channel.

• In VFO mode 47 or 23 channels can be searched. In memory mode 23 or 13 channels can be searched by the Band Scope (See "Change the number of channels displayed during scope operation" (page 12))

● Function List screen

Press the  key to display the "Function List" screen that displays only the registered items from the Setup Menu (see page 60). To return to the normal operation screen from the Function List, press the  key.



By default, the following 5 setup items are registered in the Function List. Setup Menu items can be registered, changed, or canceled at any time.



M->V	KEYPAD	TX PWR
RPT REV	RPT ARS	-
-	-	-

NOTE: The M->V cannot be changed or unregistered.

● Setup Menu screen

Press and hold the  key to display the Setup Menu screen. The Setup Menu allows selecting various functions from the displayed list and then setting the parameters of each function according individual preferences.



Press any key or **DIAL** knob, other than the  or  key, to save the settings and return to normal operation.

Safety Precautions (Be Sure to Read)

Be sure to read these important precautions, and use this product safely.

Yaesu is not liable for any failures or problems caused by the use or misuse of this product by the purchaser or any third party. Also, Yaesu is not liable for damages caused through the use of this product by the purchaser or any third party, except in cases where ordered to pay damages under the laws.



Types and meanings of the marks



 **DANGER** This mark indicates an imminently hazardous situation, which, if not avoided, could result in death or serious injury.

 **WARNING** This mark indicates a potentially hazardous situation, which, if not avoided, could result in death or serious injury.

 **CAUTION** This mark indicates a potentially hazardous situation, which, if not avoided, may result in minor or moderate injury or only property damage.

Types and meanings of symbols

 These symbols signify prohibited actions, which must not be done to use this product safely. For example:  indicates that the product should not be disassembled.

 These symbols signify required actions, which must be done to use this product safely. For example:  indicates that the power plug should be disconnected.

DANGER

 **Do not use the device in "regions or aircrafts and vehicles where its use is prohibited" such as in hospitals and airplanes.**
This may exert an impact on electronic and medical devices.

 **Do not use this product while driving or riding a motorbike. This may result in accidents.**
Make sure to stop the car in a safe location first before use if the device is going to be used by the driver.

 **Do not operate the device when flammable gas is generated.**
Doing so may result in fire and explosion.

 **Never touch the antenna during transmission.**
This may result in injury, electric shock and equipment failure.

 **Do not transmit in crowded places in consideration of people who are fitted with medical devices such as heart pacemakers.**
Electromagnetic waves from the device may affect the medical device, resulting in accidents caused by malfunctions.

 **When an alarm goes off with the external antenna connected, cut off the power supply to this radio immediately and disconnect the external antenna from this radio.**
If not, this may result in fire, electric shock and equipment failure.

 **Do not touch any liquid leaking from the liquid display with your bare hands.**
There is a risk of chemical burns occurring when the liquid comes into contact with the skin or gets into the eyes. In this case, seek medical treatment immediately.

WARNING

 Do not use voltages other than the specified power supply voltage.
Doing so may result in fire and electric shock.

 Do not transmit continuously for long periods of time.
This may cause the temperature of the main body to rise and result in burns and failures due to overheating.















 Do not dismantle or modify the device.
This may result in injury, electric shock and equipment failure.

 **Do not handle the power plug and connector etc. with wet hands. Also do not plug and unplug the power plug with wet hands.**
This may result in injury, liquid leak, electric shock and equipment failure.



















 **When smoke or strange odors are emitted from the radio, turn off the power and disconnect the power cord from the socket.**
This may result in fire, liquid leak, overheating, damage, ignition and equipment failure. Please contact our company amateur customer support or the retail store where you purchased the device.

 **Keep the power plug pins and the surrounding areas clean at all times.**
This may result in fire, liquid leak, overheating, breakage, ignition etc.

 **Disconnect the power cord and connection cables before incorporating items sold separately and replacing the fuse.**
This may result in fire, electric shock and equipment failure.

-  **Never cut off the fuse holder of the DC power cord.**
This may cause short-circuiting and result in ignition and fire.
-  **Do not use fuses other than those specified.**
Doing so may result in fire and equipment failure.
-  **Do not allow metallic objects such as wires and water to get inside the product.**
This may result in fire, electric shock and equipment failure.
-  **Do not place the device in areas that may get wet easily (e.g. near a humidifier).**
This may result in fire, electric shock and equipment failure.
-  **When connecting a DC power cord, pay due care not to mix up the positive and negative polarities.**
This may result in fire, electric shock and equipment failure.
-  **Do not use DC power cords other than the one enclosed or specified.**
This may result in fire, electric shock and equipment failure.
-  **Do not bend, twist, pull, heat and modify the power cord and connection cables in an unreasonable manner.**
This may cut or damage the cables and result in fire, electric shock and equipment failure.
-  **Do not pull the cable when plugging and unplugging the power cord and connection cables.**
Please hold the plug or connector when unplugging. If not, this may result in fire, electric shock and equipment failure.
-  **When transmitting, keep the antenna at least 1.8m (VHF) or 2.2m (UHF) away from your body.** Do not use modified or damaged antennas.
-  **RF Exposure:** This device should be operated with a minimum separation distance of 20cm (8 inches) between the equipment and a person's body.
-  **Refrain from using headphones and earphones at a loud volume.**
Continuous exposure to loud volumes may result in hearing impairment.
-  **Do not use the device when the power cord and connection cables are damaged, and when the DC power connector cannot be plugged in tightly.**
Please contact our company amateur customer support or the retail store where you purchased the device as this may result in fire, electric shock and equipment failure.
-  **Follow the instructions given when installing items sold separately and replacing the fuse.**
This may result in fire, electric shock and equipment failure.
-  **Do not use the device when the alarm goes off.**
For safety reasons, please pull the power plug of the DC power equipment connected to the product out of the AC socket.
-  **Never touch the antenna as well.** This may result in fire, electric shock and equipment failure due to thunder.

CAUTION

-  **Do not place this device near a heating instrument or in a location exposed to direct sunlight.**
This may result in deformation and discoloration.
-  **Do not place this device in a location where there is a lot of dust and humidity.**
Doing so may result in fire and equipment failure.
-  **Stay as far away from the antenna as possible during transmission.**
Long-term exposure to electromagnetic radiation may have a negative effect on the human body.
-  **Do not wipe the case using thinner and benzene etc.**
Please use a soft and dry piece of cloth to wipe away the stains on the case.
-  **Keep out of the reach of small children.**
If not, this may result in injuries to children.
-  **Do not put heavy objects on top of the power cord and connection cables.**
This may damage the power cord and connection cables, resulting in fire and electric shock.
-  **Do not transmit near the television and radio.**
This may result in electromagnetic interference.
-  **Do not use optional products other than those specified by our company.**
If not, this may result in equipment failure.
-  **When using the device in a hybrid car or fuel-saving car, make sure to check with the car manufacturer before using.**
The device may not be able to receive transmissions normally due to the influence of noises from the electrical devices (inverters etc.) fitted in the car.
-  **For safety reasons, switch off the power and pull out the DC power cord connected to the DC power connector when the device is not going to be used for a long period of time.**
If not, this may result in fire and overheating.
-  **Do not throw or subject the device to strong impact forces.**
This may result in equipment failure.
-  **Do not put this device near magnetic cards and video tapes.**
The data in the cash card and video tape etc. may be erased.
-  **Do not turn on the volume too high when using a headphone or earphone.**
This may result in hearing impairment.
-  **Do not place the device on an unsteady or sloping surface, or in a location where there is a lot of vibration.**
The device may fall over or drop, resulting in fire, injury and equipment failure.
-  **Do not stand on top of the product, and do not place heavy objects on top or insert objects inside it.**
If not, this may result in equipment failure.
-  **Do not use a microphone other than those specified when connecting a microphone to the device.**
If not, this may result in equipment failure.
-  **Do not touch the heat radiating parts.**
When used for a long period of time, the temperature of the heat radiating parts will get higher, resulting in burns when touched.
-  **Do not open the case of the product except when replacing the fuse and when installing items sold separately.**
This may result in injury, electric shock and equipment failure.

Installing the Radio

About the antenna

The antenna is an extremely important part for both transmitting and receiving. The antenna type and its inherent characteristics determine whether the performance of the transceiver can be fully realized. As such, please note the following:

- Use an antenna that is suitable for the installation conditions and application objective.
- Use an antenna that is suitable for the operating frequency band.
- Use an antenna and a coaxial cable with a characteristic feed point impedance of 50Ω .
- Adjust the VSWR (Voltage Standing Wave Ratio) until it is 1.5 or less for an antenna with an adjusted impedance of 50Ω .
- Keep the coaxial cable routing length as short as possible.

Connection of Antenna and Power Cables

Please follow the outline in the illustration regarding the proper connection of antenna coaxial cables and Power Supply.

Cautions

- Do not use a DC power supply cable other than the one that is provided.
- Do not use the DC power supply cable with the fuse holder cut OFF.
- Use an external power source capable of supplying DC 13.8 V, a current capacity of 15A or more.

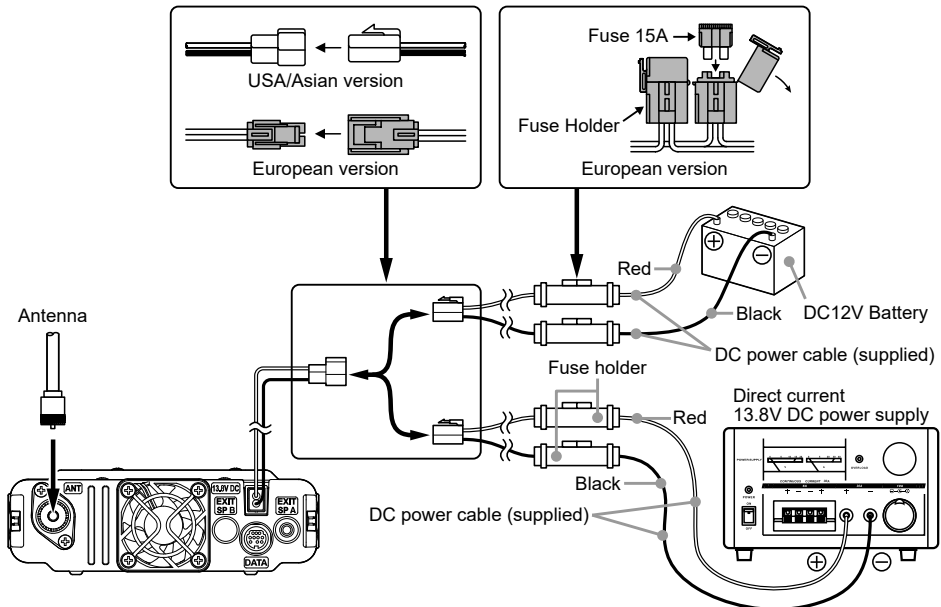

Installing the Transceiver/Microphone

The control head and main body are connected with a control cable.

When needed, use the optional Control Cable 20ft (6m) to connect the main body to the “CONTROL” terminal of the control head.

Connect the supplied microphone SSM-85D to the “MIC” terminal of the transceiver or control head.

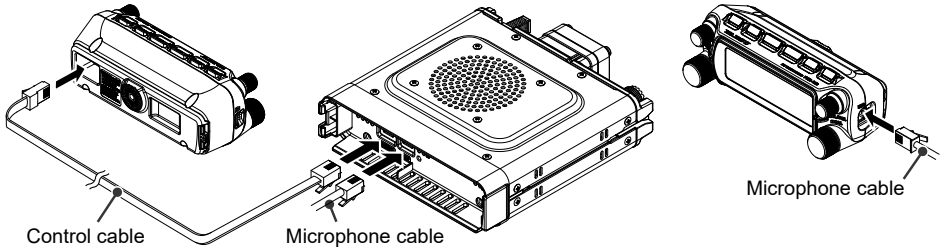

Install the main body using the supplied bracket

1. Select the installation location.

Caution : Select a location where the transceiver can be securely attached.

2. Drill four 6mm diameter holes in the location where the bracket is to be mounted, matching the positions of the bolting holes of the bracket.

The bracket can be mounted on either the top or bottom side of the radio body.

3. Insert the grooves on both sides of the main body into the bracket until they click and lock. Tighten the screw against the lever to lock the transceiver in the bracket.
4. To remove the main body from the bracket, loosen the locking screw, and then pull the transceiver out while pressing the lever indicated by the arrow below.

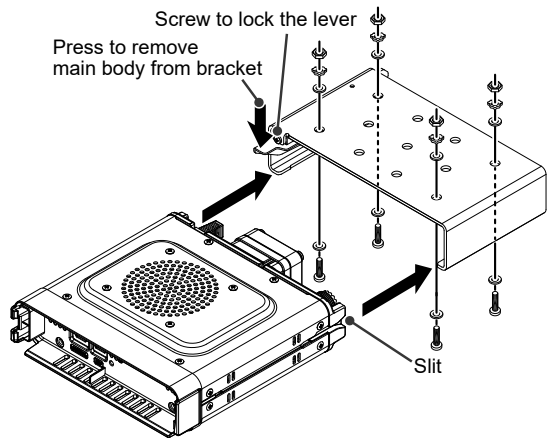

● Using the optional Dash Mount Bracket “MMB-103”

- Screw, sheet and double-sided tape are included with the bracket.
- The bracket can be formed by hand to match the location where the front panel is installed.

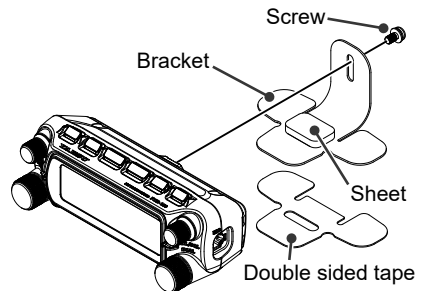

Using a Micro SD Memory Card

Using a microSD memory card with the transceiver allows the following functions.

- Backing up the transceiver data and information
- Saving memory information
- Update the firmware

Usable microSD Memory Cards

This transceiver only supports the following capacity of microSD and microSDHC memory cards.

• 2GB • 4GB • 8GB • 16GB • 32GB



- microSD memory cards formatted on other devices may not properly save information when used with this transceiver. Format microSD memory cards again with this transceiver when using memory cards formatted with another device.
- Do not remove the microSD memory card or turn the transceiver OFF, while saving data to a microSD memory card is in progress.

Mounting and Dismounting microSD Memory Card

1. Turn the transceiver **OFF**.
2. Insert a microSD memory card into the slot on the left side of the control head.

With the terminal surface of the microSD card facing the front of the control head, push it in gently until it clicks.

3. Turn the transceiver **ON**.

When the memory card is properly detected,  lights on the display.

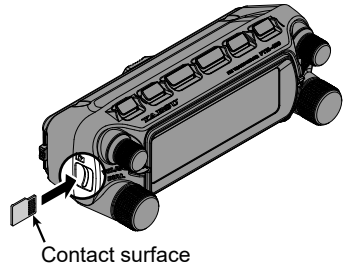

• Removing the microSD memory card

To remove the microSD memory card (inserted in step 2 above), push the memory card in until a clicking sound is heard, then remove the memory card.

Formatting a Micro SD Memory Card

Format a new microSD memory card following the steps below before use:



- A microSD memory card that was used in another device may not function properly, for example, it may not be recognized by the FTM-150R/E, or reading and writing may take an unusually long time. Use of the SD Memory Card Formatter provided by the SD Association may improve this. The SD Memory Card Formatter can be downloaded from this URL (<https://www.sdcard.org/downloads/formatter/index.html>).
- Formatting a microSD memory card erases all data saved on it. Before formatting the card, be sure to check for data and save it before formatting.

1. Press and hold the  key.
2. Rotate the Right **DIAL** knob to select [**49 SD FORMAT**], then press the Right **DIAL** knob.
“FORMAT?” appears on the LCD.
3. Rotate the Right **DIAL** knob to select [**OK**], then press the Right **DIAL** knob.
4. When formatting is completed, a beep sounds and “**Completed**” appears on the LCD.

Changing the Transmit Power Level

With the factory settings, the transmit power level changes from “HIGH” to “LOW” to “MID” when the microphone [P3] key is pressed (see the table below). The transmit power level can also be changed using the function List.

1. Press the  key.
2. Rotate the Right **DIAL** knob to select [TX PWR], then press the Right **DIAL** knob.
3. Rotate the Right **DIAL** knob to select transmit power output.

“HIGH” → “LOW” → “MID”



HIGH: 55W (144MHz), 50W (430MHz)

MID: 25W

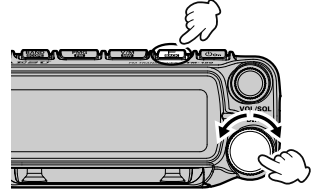
LOW: 5W





H->V	KEYPAD	TX PWR
RPT REV	RPT ARS	
HIGH		

4. Press any key or **DIAL** knob, other than the  or  key, to save the settings and return to normal operation.

 The transmit power output can be set individually for each frequency band and memory channel in each of Main-band and Sub-band.



Setting the Skip Band

Set the band selected when the  key is pressed. By storing frequently used frequencies in the memory channel before setting the band skip, can be recall the memory that stores the frequencies of the bands that cannot be selected.

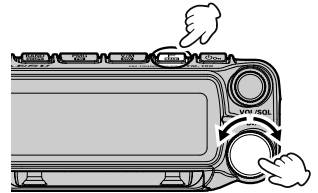
1. Press and hold the  key.
2. Rotate the Right **DIAL** knob to select [24 BAND SKIP].
3. Press the Right **DIAL** knob.



19 BEEP	
20 BAND SKIP	>
21 RPT ARS	
	>

4. Rotate the Right **DIAL** knob to select the band to set and press the Right **DIAL** knob.
5. Rotate the Right **DIAL** knob to set “ON” (selectable) or “OFF” (not selectable).
6. Press any key or **DIAL** knob, other than the  or  key, to save the settings and return to normal operation.

20 BAND SKIP	>
AIR	OFF
VHF	ON
UHF	ON

Changing the Frequency Step

The **DIAL** knob rotation frequency step may be changed. Normally, use the factory default setting of “**AUTO**”.

1. Press and hold the **[F BACK]** key.
2. Rotate the Right **DIAL** knob to select [**26 STEP**], then press the Right **DIAL** knob.
3. Rotate the Right **DIAL** knob to set the frequency step.
4. Press any key or **DIAL** knob, other than the **[F BACK]** or **[ON/OFF]** key, to save the settings and return to normal operation.

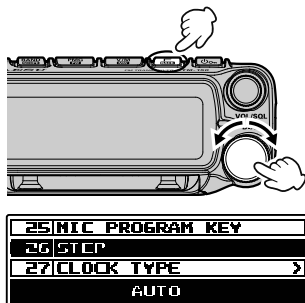

- The default setting, of the frequency step is set to “**AUTO**”, which automatically provides a suitable frequency step according to the frequency band.
- The frequency steps that can be selected depend on the frequency band.

Change the display color

The display color can be selected from “**AMBER**” and “**WHITE**”.

1. Press and hold the **[F BACK]** key.
2. Rotate the Right **DIAL** knob to select [**6 BACKLIGHT COLOR**], then press the Right **DIAL** knob.
3. Rotate the Right **DIAL** knob to select the display color.

AMBER ↔ WHITE

4. Press any key or **DIAL** knob, other than the **[F BACK]** or **[ON/OFF]** key, to save the settings and return to normal operation.

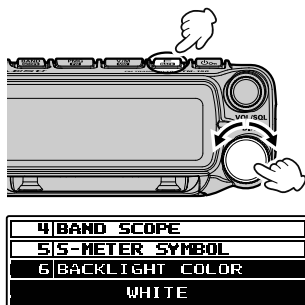

MONO Band Display

The “dual band display” shows the two bands on the left and right of the screen. Operation can be changed to a “mono band display” that operates on one band.

1. Press and hold the **[F BACK]** key.
2. Rotate the Right **DIAL** knob to select [**14 SUB BAND**], then press the Right **DIAL** knob.
3. Rotate the Right **DIAL** knob to select [**SUB BAND**], then press the Right **DIAL** knob.
4. Rotate the Right **DIAL** knob to select “**OFF**”.
5. Press any key or **DIAL** knob, other than the **[F BACK]** or **[ON/OFF]** key, to save the settings and return to normal operation.

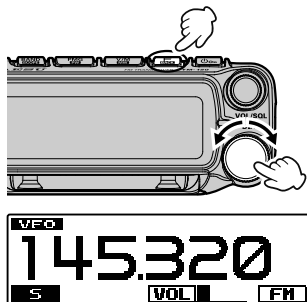

Communicating Via the Repeater

The transceiver includes an ARS (Automatic Repeater Shift) function which automatically sets the repeater operation when the receiver is tuned to the repeater frequency.

1. Set the receive frequency to the repeater frequency
“**-**” or “**+**” appears on top of the display.
2. “**-**” or “**+**” and “**TN**” icons may automatically appear above the frequency.
3. Speak into the microphone while pressing and holding the PTT switch.

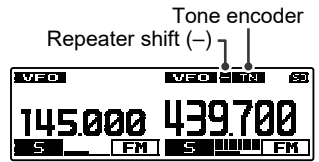

● Reverse function

The “reverse” state temporarily reverses the transmit and receive frequencies. This allows checking to find if direct communication with the other station is possible.

1. Press the key.
2. Rotate the Right **DIAL** knob to select **[RPT-R]**, then press the Right **DIAL** knob.
 - The transmit and receive frequencies are temporarily reversed (“reverse” state).
 - In the “reverse” state, the “**-**” or “**+**” blinks on the display.
3. To release the reverse state, repeat the above steps again.

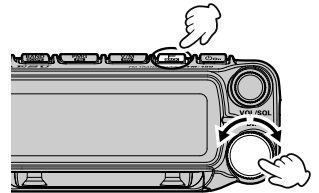

- The repeater settings may be changed from the Setup Menu.
Setup Menu [22 RPT SHIFT]: Allows setting the repeater shift direction.
Setup Menu [23 RPT SHIFT FREQ]: Allows changing the repeater shift offset.
Setup Menu [34 TONE SQL FREQ]: CTCSS Tone frequency
- Function Menu [ARS]: The ARS function may be set to OFF

● Tone Calling (1750 Hz)

If your transceiver is FTM-150E (European version), press and hold in the **[P4]** key on the microphone (in factory default setting) to generates a 1750Hz burst tone to access the European repeater. The transmitter will automatically be activated, and a 1750Hz audio tone will be superimposed on the carrier. Once access to the repeater has been gained, you may release the switch, and use the switch for activating the transmitter thereafter. If you need to access the repeaters which requires a 1750Hz burst tone for access by the FTM-150R (USA versions), you can set the program key on the microphone to serve as a “**T-CALL**” key instead. To change the configuration of this switch, use setup menu **[25 MIC PROGRAM KEY]**.

Using the Memory

The FTM-150R/E incorporates a Large number of memory channels that can register the operating frequency, communication mode, and other operational information.

- 999 Memory Channels
 - 4 Home Channels
 - 50 pairs PMS Memory Channels
- The memory auto grouping (MAG) function can automatically recall a list of memory channels from the same frequency band as a group.
- The PMG (Primary Memory Group) function displays the status of registered frequently used frequencies (received signal strength) in a bar graph.

The operating frequency and other operational information can be registered to each regular memory channel, home channel, or PMS memory channel:

- Operating frequency
- Frequency Step
- Transmitter output
- Memory tag
- Repeater Shift
- Tone information
- DCS information
- Memory channel skip information

NOTE

Back up the stored contents to a microSD memory card. For details on backing up to a microSD card. See the Advanced Manual for details on backing up to a microSD card.

Writing to memory

1. Set the frequency to write to memory.

2. Press and hold the  key.

The memory channel list appears.

The memory channel list can also be displayed by the following operations:



Press the  key → Select **[KEYPAD]** → Press the Right **DIAL** knob → Select **[MEM LIST]** → Press the Right **DIAL** knob

The last used memory channel is selected.

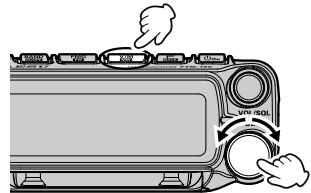

The lowest available number is selected. To select another channel, rotate the Right **DIAL** knob to select the memory channel number to be written.

HOM	145.000	
001	145.240	
002	---	---
003	---	---

- Rotate the Left **DIAL** knob, or press the [UP] or [DWN] key on the microphone to fast-forward in 10-channel steps.
- Press the number keys on the microphone to quickly select a memory channel as shown in the example below:



Press the [**1**] key: Memory channel **100**

Press the [**A**] key: PMS Memory channel **L01**

- When [**HOM**] at the top of the memory channel list is selected, the HOME channel of the current frequency band can be overwritten.



For already written memory channels, the writing frequency is displayed.

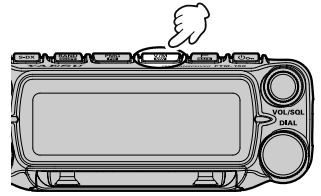

- Press and hold the  key.
If the memory channel already contains frequency data, "OVER WRITE?" will appear on the screen. Press and hold the  key to overwrite the memory channel.



- Press the  key, and the screen returns to the previous display.

Recall memory (There are three ways)

(1) Press the key

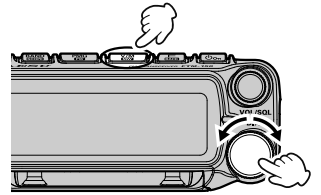

- Press the  key.
The last used memory channel is recalled.
- Rotate the **DIAL** knob to select the memory channel to recall.
Press and then turn the **DIAL** knob to select in 10 channel steps.
- Press the  key again to return to VFO mode.

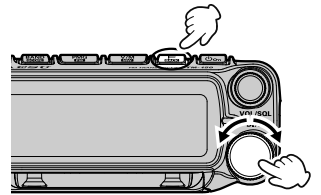

(2) Recall a memory from MEMORY CH LIST

- Press the  key.
- Rotate the Right **DIAL** knob, select [KEYPAD], then press the Right **DIAL** knob to display the direct frequency input screen.
- Rotate the Right **DIAL** knob to select [MEM LIST] then press the Right **DIAL** knob to display the memory channel list.



 The memory channel list can also be displayed by the following operations.
Press and hold the  key → Select [16 MEMORY LIST] → Press the Right **DIAL** knob

M->V	KEYPAD	TX PWR
RPT REV	RPT ARS	

- Rotate the Right **DIAL** knob, select the memory channel to recall.
 - Rotate the Left **DIAL** knob, or press the [UP] or [DWN] key on the microphone to fast-forward in 10-channel steps.
 - Press the number keys on the microphone to quickly select a memory channel as shown in the example below:
Press the [1] key: Memory channel 100
Press the [A] key: PMS Memory channel L01
- Press the Right **DIAL** knob. A pop-up with [MR] highlighted appears. Press the Right **DIAL** knob.
The selected memory channel will be recalled.

FREQUENCY				
1	2	3	4	5
6	7	8	9	0
MEM CH	MEM LIST	←		

HOM	145.000	
001	145.240	
002	145.250	
003	433.240	

HOM	145.2	MR	
001	145.2	WRITE	
002	145.2	EDIT	
003	433.2	GRP ON	

MAIN	VFO	68
002	745.360	433.000
S	FM	S FM

(3) Recalling a memory by directly entering the channel number

● Recalling a memory on the keypad screen

1. Press the  key.
2. Rotate the Right **DIAL** knob, select **[KEYPAD]**, then press the Right **DIAL** knob to display the direct frequency input screen.

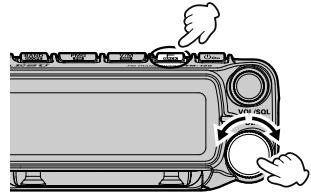

3. Rotate the Right **DIAL** knob to select **[MEM CH]** then press the Right **DIAL** knob to display the memory channel number input screen.



4. Rotate the Right **DIAL** knob to select a memory channel number, then press the Right **DIAL** knob.

(Example) When recalling memory channel "123".

Rotate the **DIAL** knob to select **[1]** → Press the **DIAL** knob



Rotate the **DIAL** knob to select **[2]** → Press the **DIAL** knob



Rotate the **DIAL** knob to select **[3]** → Press the **DIAL** knob

(Example) When recalling memory channel "16".

Rotate the **DIAL** knob to select **[1]** → Press the **DIAL** knob



Rotate the **DIAL** knob to select **[6]** → Press the **DIAL** knob



Press and hold the Right **DIAL** knob

● Recall a memory by directly inputting channels using the numeric keys on the microphone

Press the numeric keys "0" to "9" in the memory mode to enter the memory channel.

(Example) When recalling memory channel "123".

Press the **[1]** → **[2]** → **[3]** key.

(Example) When recalling memory channel "16".

Press the **[1]** → **[6]** key.



Press and hold any numeric key.

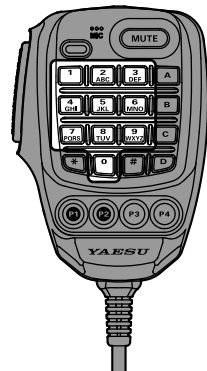

Press the **PTT** switch while entering a number to cancel the entry.

Recall only memories in the same frequency band (Band) using the memory auto grouping (MAG) function

With the memory auto grouping (MAG) function, only memory channels in the same frequency band (Band) can be called.

In the memory mode, each time the **BAND GROUP** key is pressed, only memory channels of the specified frequency band are automatically recalled as a group, as shown below:

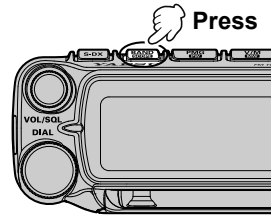

- When **M-ALL** is selected, the MAG function is turned OFF and all memory channels can be recalled.
- **M-GRP** allows grouping frequently used memory channels regardless of frequency band.
- If there is nothing registered in M-GRP (Memory Group), **M-GRP** and "-----" will be displayed.

Group	Selectable Memory Channels
M-ALL	All memory channels.
M-AIR	AIR band (108 - 137MHz) memory channels only.
M-VHF	144MHz band (137 - 174MHz) memory channels only.
M-UHF	430MHz band (400 - 550MHz) memory channels only.
OTHER	174MHz to 400MHz Memory channels.
M-GRP	Frequently used memory channels regardless of the frequency band, can be registered in advance, and called up in the M-GRP (Memory Group).



Refer to the next page for instructions to register with M-GRP.

Registering frequently used memory channels in M-GRP (Memory Group)

1. Press and hold the  key in VFO or memory mode.

The memory channel list is displayed.

2. Rotate the Right **DIAL** knob to select the memory channel to be registered in the M-GRP.

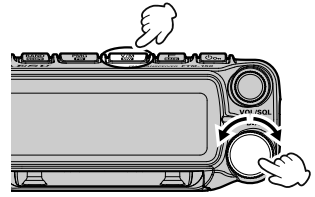

HOM 145.000	
001 145.240	
002 145.360	
003 -----	

3. A pop-up screen will appear, then rotate the Right **DIAL** knob to select **[GRP ON]**.
4. Press the Right **DIAL** knob to register to the M-GRP (Memory Group).

HOM 145.0	MR
001 145.2	WRITE
002 145.3	EDIT
003 ---	GRP ON



The memory channel numbers registered in the M-GRP are displayed in negative and positive inversion.

HOM 145.000	
001 145.240	
002 145.360	
003 -----	

Unregistering memory from M-GRP (Memory Group)

1. Press and hold the  key.

The memory channel list is displayed.

2. Rotate the Right **DIAL** knob to select the channel to be unregistered.
3. Press the Right **DIAL** knob.

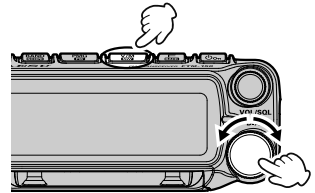

HOM 145.000	
001 145.240	
002 145.360	
003 -----	

4. A pop-up screen will appear, then rotate the Right **DIAL** knob to select **[GRP ON]**.
5. Press the Right **DIAL** knob to unregister it from the M-GRP (Memory Group).

HOM 145.0	MR
001 145.2	WRITE
002 145.3	EDIT
003 ---	GRP ON

Edit memory

● Edit memory tag

Memory name tags, such as a call sign or broadcast station name may be assigned to the memory channels and home channels. Input a memory tag using up to 8 characters. Alphabetic characters (upper and lowercase), Numbers and Symbols may be entered to the memory name tag.

1. Press and hold the  key.

The memory channel list appears. The lowest available number is selected.

The memory channel list can also be displayed by the following operations:



Press the  key → Select [KEYPAD] → Press the Right **DIAL** knob → Select [MEM LIST] → Press the Right **DIAL** knob

The last used memory channel is selected.

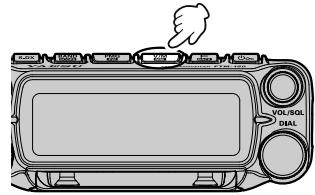

001	145.240	
002	145.360	
003	433.240	
004	---	---

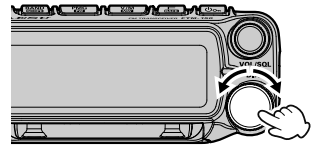

001	145.2	NR	
002	145.3	WRITE	
003	433.2	EDIT	
004	---	GRP ON	

RX FREQ	145.360
TX FREQ	---
TAG	
SCAN	YES

YAESL
A B C D E F G H I J K L M
N O P Q R S T U V W X Y Z
abc 123 % ^ * & #



2. Rotate the Right **DIAL** knob to select the memory channel for editing the memory tag, then press the Right **DIAL** knob.

- Rotate the Left **DIAL** knob, or press the [UP] or [DWN] key on the microphone to fast-forward in 10-channel steps.

3. A popup will appear. Rotate the Right **DIAL** knob to select [EDIT], then press the Right **DIAL** knob. The memory information appears.

4. Rotate the Right **DIAL** knob to select [TAG], then press the Right **DIAL** knob.

- The character input screen is displayed. Rotate the Right **DIAL** knob to select a character, and press the Right **DIAL** knob to enter the character.

 /  : displays the alphabet keypad input screen.

 : displays the numeric keypad input screen.

 : displays the symbols keypad input screen.

 : moves the cursor to the left.

 : enter a space at the cursor position.

 : moves the cursor to the right.

 : erases the character to the left of the cursor and moves the cursor to the left.

- See “Text input screen” on page 65 to input a memory tag.

5. When input is complete, press and hold the Right **DIAL** knob to save the characters.
6. Press and hold the Right **DIAL** knob.
7. A confirmation pop-up appears. Select [OK] then press the Right **DIAL** knob to complete the memory tag entry.

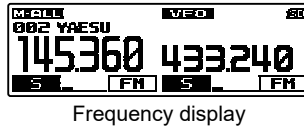
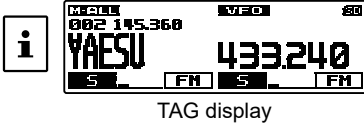

When the memory is called up, pressing the **DIAL** knob briefly will switch the display.



● Clearing Memories

1. Press and hold the  key.
The memory channel list appears. The lowest available number is selected.

The memory channel list can also be displayed by the following operations:

 Press the  key → Select **[KEYPAD]** → Press the Right **DIAL** knob → Select **[MEM LIST]** → Press the Right **DIAL** knob

The last used memory channel is selected.

2. Rotate the Right **DIAL** knob to select the memory channel from which the data is to be cleared, and press the Right **DIAL** knob.
 - Rotate the Left **DIAL** knob, or press the **[UP]** or **[DWN]** key on the microphone to fast-forward in 10-channel steps.

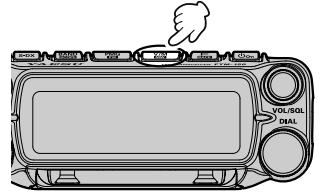

001	145.240	
002	145.360	
003	433.240	
004	---	---

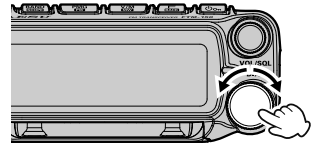

3. A popup will appear. Rotate the Right **DIAL** knob to select **[DELETE]** then press the Right **DIAL** knob. Confirmation screen “**DELETE?**” is displayed.
4. Rotate the Right **DIAL** knob to select **[OK]**, then press the Right **DIAL** knob.

001	145.240	WRITE
002	145.360	EDIT
003	433.240	GRP ON
004	---	DELETE

001	145.240	
002		DELETE?
003		OK CANCEL
004	---	---



Data on memory channel 001, and the Home channel may not be cleared.

Recalling the Home Channels

● Recall with the programmable key on the microphone

1. Press the **[P2]*** key on the microphone.

* This is the factory setting. This function can also be assigned to the **[P1]**, **[P3]** or **[P4]** key (see page 24).

2. Press the **[P2]** key again, to return to the previous frequency.

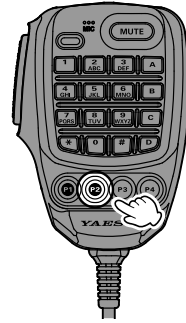

● Recall from the Set Up Menu

1. Press and hold the **[F BACK]** key.
2. Rotate the Right **DIAL** knob, to select **[15 HOME CH]**, then press the Right **DIAL** knob. "HOME" and the home channel frequency of the currently selected band appears on the LCD.

15 HOME CH	>
16 MEMORY LIST	>
17 MEMORY LIST MODE	
to HOME CH	



While recalling the home channel, rotate the **DIAL** knob to transfer the home channel frequency to the operating band VFO.

Changing the Home Channel Frequency

1. Set the frequency and the operating mode to be stored as a home channel.
2. Press and hold the **[V/M EDIT]** key.
The memory channel list appears.

The memory channel list can also be displayed by the following operations:



Press the **[F BACK]** key → Select **[KEYPAD]** → Press the Right **DIAL** knob → Select **[MEM LIST]** → Press the Right **DIAL** knob

The last used memory channel is selected.

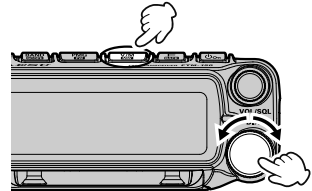

3. Rotate the Right **DIAL** knob to select **[HOM]** displayed at the top of the memory channel list.
4. Press the Right **DIAL** knob to display a popup.
5. Rotate the Right **DIAL** knob to select **[WRITE]**, then press the Right **DIAL** knob.
Confirmation screen "OVER WRITE?" is displayed.
6. Rotate the Right **DIAL** knob to select **[OK]**, then press the Right **DIAL** knob.
7. The contents of the home channel are changed and the previous screen returns.

HOM	145.000	
001	145.240	
002	145.360	
003	143.240	

HOM	145.0	NR	
001	145.0	WRITE	
002	145.0	EDIT	
003	143.0		

Split Memory

Two different frequencies, one for receive and another for transmit, can be registered to a memory channel.

1. Register the receive frequency to a memory channel first.
For additional details on registering to a memory channel, refer to page 36.
To edit a memory channel that has already been written, go to step 2.
2. Press and hold the  key.
The memory channel list appears.

The memory channel list can also be displayed by the following operations:



Press the  key → Select **[KEYPAD]** → Press the Right **DIAL** knob → Select **[MEM LIST]** → Press the Right **DIAL** knob

The last used memory channel is selected.



3. Rotate the Right **DIAL** knob to select the channel number that the receive frequency was registered to on step 1, and press the Right **DIAL** knob.
4. Rotate the Right **DIAL** knob to select **[EDIT]**, then press the Right **DIAL** knob.
5. Rotate the Right **DIAL** knob to select **[TX FREQ]**, then press the Right **DIAL** knob.
6. Set the transceiver to the desired transmit frequency.

001	145.2	MR	
002	145.2	WRITE	
003	433.2	EDIT	
004	---	GRP ON	

RX FREQ	145.360
TX FREQ	---.----
TAG	
SCAN	YES

433.	---			
1	2	3	4	5
6	7	8	9	0
				

RX FREQ	145.360
TX FREQ	433.360
TAG	
SCAN	YES

7. Press and hold the Right **DIAL** knob.
8. Confirmation screen is displayed, press the Right **DIAL** knob.
9. Press the  key, to save the settings and return to normal operation.
When recalling the split memory “” is displayed on the LCD.

RX FREQ	145.360
TX	
Ti	OK CANCEL
SCAN	YES

MEM 002	VFO	50
145.360	433.240	
5	FM	5
	FM	

While operating the split memory, to reverse the transmit and receive frequencies temporarily:



Press the  key → Select **[RPT REV]** → Press the Right **DIAL** knob

When reversing the frequencies, “” will blink.

Scanning Function

The FTM-150R/E supports the following three scanning functions:

- VFO Scan
- Memory Scan
- Programmable Memory Scan (PMS)

VFO Scan / Memory Scan

To find frequencies where there are signals in VFO mode or Memory mode:

1. Press the **V/M** key to select the “VFO mode” or “Memory mode”.
2. Press and hold the microphone **[UP]** or **[DWN]** switch to start scanning.

Or press and hold the **F** key → **[40 SCAN]** → Press the Right **DIAL** knob.

- If the **DIAL** knob is rotated while scanning is in progress, the scanning will continue up or down in frequency according to the direction of the **DIAL** Knob rotation.
- When a signal is received, the scan pauses, the frequency flashes, and the scan starts again after about 3 seconds. In the USA version, the scan will continue to pause while receiving the signal.

• Stop scanning

1. Press the **PTT** or the **[UP]** / **[DWN]** keys on the microphone.

Or press and hold the **F** key → **[40 SCAN]** → Press the Right **DIAL** knob.

- If the scan has paused on a signal, rotating the **DIAL** knob will cause scanning to resume instantly.
- If the transceiver is turned **OFF** while scanning, when the transceiver is turned **ON**, scanning will resume.
- If you call the Function List or Setup Menu during scanning, the **SCAN** item is automatically selected and you cannot select any other item.

Setting the Receive Operation When Scanning Stops

1. Press and hold the **F** key.
2. Rotate the Right **DIAL** knob to select **[44 SCAN RESUME]**, then press the Right **DIAL** knob.
3. Rotate the Right **DIAL** knob to select the hold time after the scan is paused:

• BUSY

The signal is received until the signal fades out. Two seconds after the signal fades out, scanning resumes.



• HOLD

Scanning stops and tuning remains on the current receive frequency (Scanning does not resume).

• 1 sec / 3 sec / 5 sec

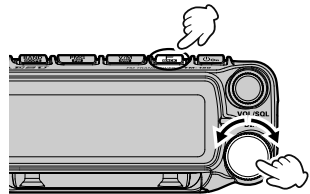
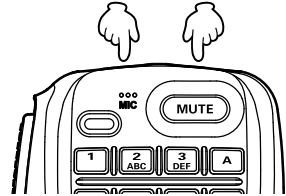
The signal is received for a specified period of time, and then scanning resumes. Factory default setting: **BUSY**



- Press any key or **DIAL** knob, other than the  or  key, to save the settings and return to normal operation.

 The above settings are common for VFO scan, memory scan and programmable memory scan (PMS).



Skip Memory Channels

Each memory channel can be set to be skipped during memory scan.

- Press and hold the  key.

The memory channel list appears.

The memory channel list can also be displayed by the following operations:

 Press the  key → Select **[KEYPAD]** → Press the Right **DIAL** knob → Select **[MEM LIST]** → Press the Right **DIAL** knob

The last used memory channel is selected.

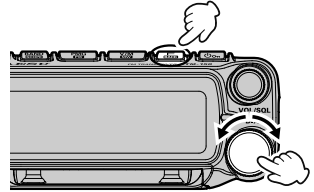

- Rotate the Right **DIAL** knob to select the memory channel number that you do not want to scan, and press the Right **DIAL** knob.
- Rotate the Right **DIAL** knob to select **[EDIT]**, then press the Right **DIAL** knob.
- Rotate the Right **DIAL** knob to select **[SCAN]**, then press the Right **DIAL** knob to select **[NO]**.
- Press and hold the Right **DIAL** knob.

001	145.2	MR	
002	145	WRITE	
003	433	EDIT	
004	---	GRP ON	

RX FREQ	145.360
TX FREQ	---.---
TAG	
SCAN	NO

- When the confirmation screen is displayed, press the Right **DIAL** knob.

RX FREQ	145.360
TX FREQ	
TAG	OK CANCEL
SCAN	NO

When the memory channel set as the skip memory is called, the "X" icon is displayed.

MEM LIST	VFO	62
002	145.360 (X)	433.000
S	FM	S FM

 To cancel the skip memory, set it to "YES" in step 4 above.

Programmable Memory scan (PMS)

This function scans only the range of frequencies between the lower and upper limits registered in a pair of PMS Programmable Memory channels. 50 sets of PMS memory channels (L01/U01 to L50/U50) are available.

 For additional details on the Programmable Memory Scan (PMS) and Memory Bank Scan, refer to the Advanced Manual which may be downloaded from the Yaesu website.

Convenience Features

Bluetooth® Operation (Requires optional BU-5)

The FTM-150R/E can be equipped with the **Bluetooth®** function by installing the optional **Bluetooth®** unit "BU-5". Remote operation is possible using the optional **Bluetooth®** headset (SSM-BT20) or a commercially available **Bluetooth®** headset.



The operation of all commercially available **Bluetooth®** headsets cannot be guaranteed.

Installing the Bluetooth® unit "BU-5"



Avoid touching the electronic components with your hands as the semiconductors may be damaged by static electricity.

1. Turn the transceiver OFF.
2. Unplug the control cable from the front panel.
3. Remove the 4 screws from the front panel and then carefully lift the back case of the front panel.
4. Unplug the speaker cables extending from the socket on the board inside the front panel.

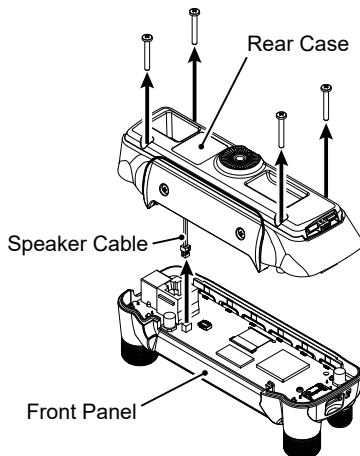

5. Apply double-sided tape to BU-5. Double-sided tape is included with the BU-5.
6. Align the BU-5 connector with the connector on the board and install.
7. Plug in the speaker cables extending from the front panel to the original connector on the board.
8. Carefully attach the back cover and secure it with the 4 screws.

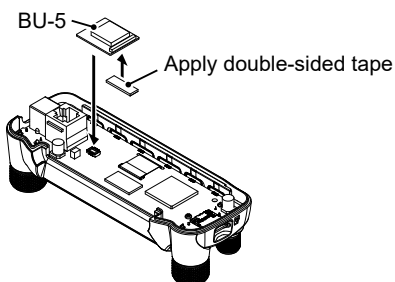

● **Subsequent Bluetooth® headset connection when the power is turned ON**

- When the power is turned **OFF** while the **Bluetooth®** headset is connected, the next time the power is turned **ON**, the same **Bluetooth®** headset is searched for and automatically connected when found.
- If the **Bluetooth®** headset cannot be found, the “” icon blinks on the screen. If the power of the same **Bluetooth®** headset is turned **ON** in this state, it will connect automatically. If not, turn the **FTM-150R/E** and **Bluetooth®** headset **OFF** and then **ON** again.
- To connect to other **Bluetooth®** headsets, refer to “Connect with another **Bluetooth®** headset” on page 51.

**Transmit operation by pressing the button on the Bluetooth® headset
(when the VOX function is OFF)**

When the **VOX** function is **OFF**, pressing the “Call button”* on the **Bluetooth®** headset once will engage the **FTM-150R/E** in transmit, and then a call can be made using the **Bluetooth®** headset.

Press the “Call button”* again to return the **FTM-150R/E** to receive.

*The button name may differ depending on your **Bluetooth®** headset.

SSM-BT20: When the **Multi-Function** Key is pressed, a beep will sound and the **FTM-150R/E** will continuously transmit.

Press the **Multi-Function** Key again, a beep will sound and the **FTM-150R/E** will return to receive mode.

Press briefly to transmit

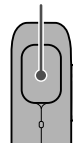

Hands-free VOX operation with a Bluetooth® headset

When **FTM-150R/E VOX** (automatic voice transmission) function is turned **ON**, the **Bluetooth®** headset can perform hands-free operation and transmit automatically just by talking. Turn the **VOX** function **ON** according to “VOX Operation” instructions.



The **VOX** function is commonly used for the **Bluetooth®** headset and microphone. If you do not use the **Bluetooth** headset and do not want to use the **VOX** function with the microphone, set this to “**OFF**”.

Connect with another Bluetooth® headset

1. Turn the **Bluetooth**® headset you are currently using OFF.
2. Press and hold the  key.
3. Rotate the Right **DIAL** knob to select [**50 Bluetooth**], then press the Right **DIAL** knob.

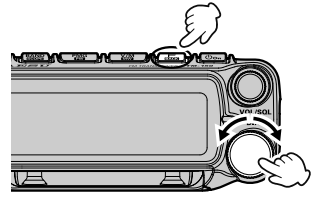

50 Bluetooth	>
51 VOICE MEMORY	
52 FVS REL	
	>

4. Rotate the Right **DIAL** knob to select [**DEVICE**], then press the Right **DIAL** knob.
5. Rotate the Right **DIAL** knob to select [**NEW**], then press the Right **DIAL** knob.

50 Bluetooth	
Bluetooth	ON
DEVICE	SSM-BT20
AUDIO	AUTO

The search starts, and the model name of the found **Bluetooth**® device is displayed in the list.

6. When the headset to be connected is displayed, rotate the Right **DIAL** knob to select the **Bluetooth**® headset to be connected.
7. Press the Right **DIAL** knob to stop searching.
8. [**CONNECT**] appears highlighted. Press the Right **DIAL** knob to connect.

● Delete all registered (paired) Bluetooth® devices from the list

1. Turn the **Bluetooth**® headset you are currently using OFF.
2. Press and hold the  key.
3. Rotate the Right **DIAL** knob to select [**50 Bluetooth**], then press the Right **DIAL** knob.
4. Rotate the Right **DIAL** knob to select [**DEVICE**], then press the Right **DIAL** knob.
5. Rotate the Right **DIAL** knob to select [**DEL ALL**], then press the Right **DIAL** knob.

ALL **Bluetooth**® headsets are deleted from the device list.



All registered Bluetooth® headsets are deleted. Headsets cannot be deleted individually.

Bluetooth® received audio output

When a Bluetooth® headset is connected, the received audio can automatically be output from the headset only, or from both the headset and the transceiver speaker.

1. Press and hold the  key.
2. Rotate the Right **DIAL** knob to select **[50 Bluetooth]**, then press the Right **DIAL** knob.

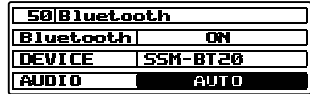
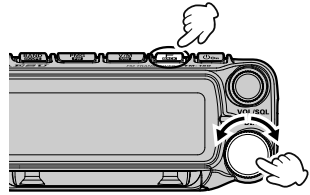



3. Rotate the Right **DIAL** knob to select **[AUDIO]**, then press the Right **DIAL** knob.
4. Rotate the Right **DIAL** knob to select "AUTO" or "FIX".

AUTO : The received audio comes from only the Bluetooth headset.

FIX : The received audio comes from both the Bluetooth headset and the speaker of this transceiver.

Factory default value: "AUTO".

5. Press any key or **DIAL** knob, other than the  or  key, to save the settings and return to normal operation.

VOX Operation

Using a **Bluetooth**® headset, you can transmit hands-free automatically, just by speaking into the microphone.

Setting VOX function

1. Press and hold the  key.
2. Rotate the Right **DIAL** knob to select [9 VOX], then press the Right **DIAL** knob.
3. Rotate the Right **DIAL** knob to select “LOW” or “HIGH”.

OFF : VOX function **OFF**

LOW : VOX function **ON** (VOX Gain Level “LOW”)

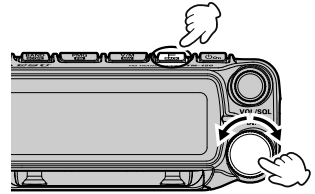

HIGH : VOX function **ON** (VOX Gain Level “HIGH”)

When set to “LOW” or “HIGH”, the sound is automatically transmitted by voice from the connected **Bluetooth**® headset. When not connected to a **Bluetooth**® headset, the sound from the microphone is automatically transmitted.



9 VOX	>
10 AUTO DIALER	
11 TOT	>
	>

9 VOX	
VOX	HIGH
DELAY	0.5sec
VOX MIC	FRONT

4. Press any key or **DIAL** knob, other than the  or  key, to save the settings and return to normal operation.

● Disable the VOX function

To cancel **VOX** and return to **PTT** operation, just repeat the above procedures, selecting “OFF” in step 3 above.



Set the VOX (Voice Operated Transmit) delay time

During transmissions using the **VOX** (Voice Operated Transmit) function, set the time to return to receive when speaking is paused:

1. Press and hold the  key.
2. Rotate the Right **DIAL** knob to select [9 VOX], then press the Right **DIAL** knob.
3. Rotate the Right **DIAL** knob to select [DELAY], then press the Right **DIAL** knob.
4. Rotate the Right **DIAL** knob to select the delay time (the transmit-receive delay after the cessation of speech).

0.5sec / 1.0sec / 1.5sec / 2.0sec / 2.5sec / 3.0sec

Factory default value: “0.5sec”.

5. Press any key or **DIAL** knob, other than the  or  key, to save the settings and return to normal operation.

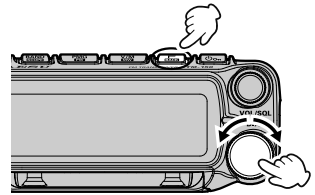

9 VOX	>
10 AUTO DIALER	
11 TOT	>
	>

9 VOX	
VOX	HIGH
DELAY	0.5sec
VOX MIC	FRONT

Dual Receive Function

While receiving on the VFO or Memory Channel, the transceiver checks for signals on the HOME channel once every 5 seconds. When a signal is received on the HOME channel, the priority scan pauses, allowing reception of the signal. When there is no signal on the HOME channel for about 5 seconds, the transceiver will resume Priority Scan.

The transceiver monitors signals on the frequency registered to the Priority HOME Channel, once approximately every 5 seconds.

VFO or Memory channel



The transceiver returns to the previous frequency quickly and continues to receive mode when there is no signal.

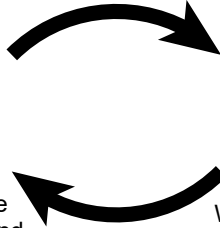

HOME channel (Priority Channel)



When the transceiver receives a signal on the frequency registered to the priority memory channel, dual reception stops and signal receiver switches to priority memory channel.

Activating Priority Scan

1. Press and hold the key.
2. Rotate the Right **DIAL** knob to select [41 DUAL RECEIVE MOD], then press the Right **DIAL** knob.
3. Rotate the Right **DIAL** knob to select [PRIORITY SCAN], then press the Right **DIAL** knob.
4. Press any key or **DIAL** knob, other than the or key, to save the settings and return to normal operation.
5. Dual receive function is activated.

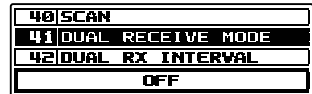
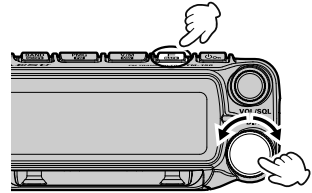

Disable the Priority Scan function

To cancel Priority Scan, just repeat the above procedures, selecting "OFF" in step 3 above.

Using the Voice Recorder

The receive audio can be recorded and then played back later using the optional voice guide unit "FVS-2". The frequency of the operating band can also be announced by voice when the announce function is set to ON.

Installing the Voice Guide Unit "FVS-2"

1. Turn the transceiver OFF.
2. Disconnect all the cables and the microphone from the transceiver.
3. Remove the 8 screws from the main body, 4 on top and 2 each at the sides.

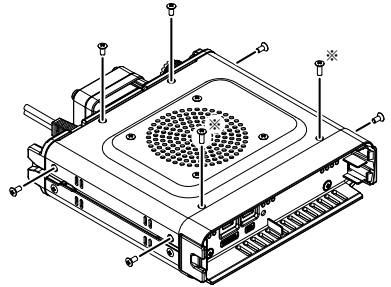

4. Carefully lift the top cover of the main body.
5. Unplug the speaker cables extending from the top cover from the socket on the board inside the main body before removing the cover.

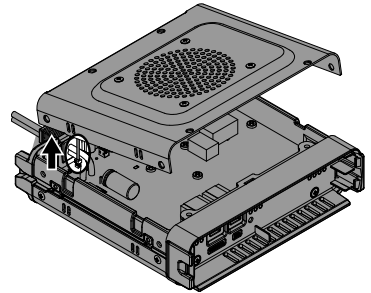

6. Refer to the illustration for the mounting location of the FVS-2.
7. Plug in the speaker cables extending from the main body top cover to the original connector on the board.

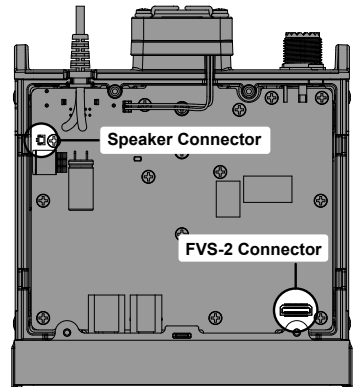

8. Replace the top cover and secure it using the 8 screws.



*Please note that the 2 screws on the front panel side of the top cover are longer than the other 6 screws.



Setting the voice memory operation

1. Press and hold the  key.
2. Rotate the Right **DIAL** knob to select [**51 VOICE MEMORY**], then press the Right **DIAL** knob.
3. Rotate the Right **DIAL** knob to select [**PLAY/REC**], then press the Right **DIAL** knob.
4. Rotate the Right **DIAL** knob to select recording operation.

FREE 5min: A total of 5 minutes of audio in 8 recording areas can be recorded.



LAST 30sec: The last 30 seconds will be recorded.

Factory default value: FREE 5min

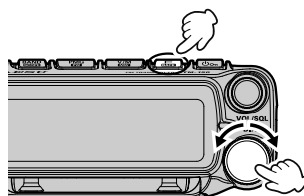
5. Press any key or **DIAL** knob, other than the  or  key, to save the settings and return to normal operation.



Recording the receive audio

1. Press and hold the  key.
2. Rotate the Right **DIAL** knob to select [**52 FVS REC**].
3. Press the Right **DIAL** knob.
 - The recording will be started.
 - The “RECORDING” display will blink while recording.
4. Press any key or **DIAL** knob, other than the Right **DIAL** knob or  key, to return to the operation screen while still recording.

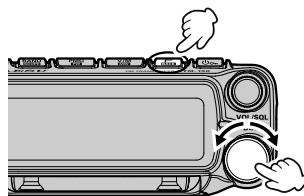

Recording is stopped when the transceiver is turned OFF.

Disable the recording function

1. Press and hold the  key.
2. Rotate the Right **DIAL** knob to select [**55 FVS REC**].
3. Press the Right **DIAL** knob.

The recording will stop.

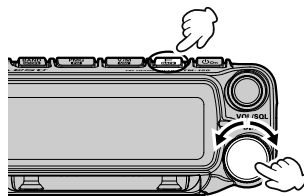

Playback the recorded audio

1. Press and hold the  key.
2. Rotate the Right **DIAL** knob to select [53 TRACK SELECT], then press the Right **DIAL** knob.
3. Rotate the Right **DIAL** knob to select the track number to be replayed.

When “ALL” is selected, all the recorded tracks will be replayed in sequence.

4. Press the Right **DIAL** knob.
5. Rotate the Right **DIAL** knob to select [54 FVS PLAY], then press the Right **DIAL** knob.
 - Replay will be started.
 - The “PLAYING” display will blink while in playback.
6. Press any key or **DIAL** knob, other than the Right **DIAL** knob or  key, to return to the operation screen, while still in playback.

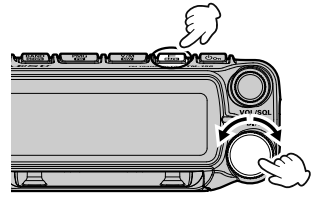

Stop playback

1. Press and hold the  key.
2. Rotate the Right **DIAL** knob to select [55 FVS STOP], then press the Right **DIAL** knob.

The playback will stop.

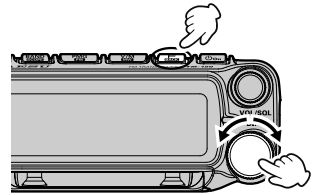

Delete files



All recorded audio will be erased. When there are two or more recordings, individual tracks cannot be erased.

1. Press and hold the  key.
2. Rotate the Right **DIAL** knob to select [56 FVS CLEAR], then press the Right **DIAL** knob.

The confirmation screen will be displayed.
3. Rotate the Right **DIAL** knob to select [OK], then press the Right **DIAL** knob.
 - Erasing will be started.
 - When erasing is complete, the blinking “ERASING” will change to a steady “ERASE”.
4. Press any key or **DIAL** knob, other than the Right **DIAL** knob or  key, to return to the normal operation.

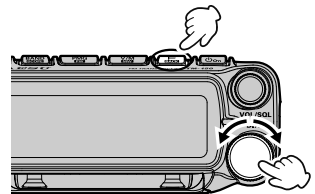

Voice announcement of the operating frequency

Setting the announce function operation

Set the following voice announcement parameters:

- Automatically announce the frequency or not
- Announce the frequency in English or Japanese
- Voice announcement audio level
- Mute the receive audio during a voice announcement.

1. Press and hold the  key.
2. Rotate the Right **DIAL** knob to select [**51 VOICE MEMORY**], then press the Right **DIAL** knob.
3. Rotate the Right **DIAL** knob to select [**ANNOUNCE**], then press the Right **DIAL** knob.
4. Rotate the Right **DIAL** knob to select the condition for reading out the frequency.

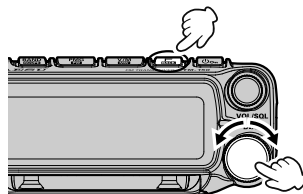

OFF: The frequency is not announced.

MANUAL: To announce the frequency, press and hold the  key → [**57 VOICE GUIDE**] → Press the Right **DIAL** knob.

AUTO: The frequency is announced when changing bands, switching between VFO mode and Memory mode, or it is announced by pressing and holding the  key → [**57 VOICE GUIDE**] → Press the Right **DIAL** knob.

Factory default value: **AUTO**

5. Press the Right **DIAL** knob.
6. Rotate the Right **DIAL** knob to select [**LANGUAGE**], then press the Right **DIAL** knob.
7. Rotate the Right **DIAL** knob to select the language in which the frequency is announced.

The setting will switch between “ENGLISH” and “JAPANESE”.

Factory default value: **ENGLISH**

8. Rotate the Right **DIAL** knob to select [**VOLUME**], then press the Right **DIAL** knob.
9. Rotate the Right **DIAL** knob to select the announcement volume.

The setting will switch between “HIGH”, “MID” and “LOW”.

Factory default value: **HIGH**

10. Press the Right **DIAL** knob.
11. Rotate the Right **DIAL** knob to select [**RX MUTE**], then press the Right **DIAL** knob.
12. Rotate the Right **DIAL** knob to select ON/OFF.

ON: The receive audio will be muted during a voice announcement or replaying recorded audio.

OFF: The receive audio will not be muted during a voice announcement or replaying recorded audio.

Factory default value: **ON**

13. Press any key or **DIAL** knob, other than the Right **DIAL** knob or  key, to return to normal operation.

Weather Broadcast Reception

The **FTM-150R/E** includes a unique feature which allows reception of weather broadcasts in the 160MHz frequency range. Ten standard Weather Broadcast channels are preloaded into a special memory bank.

To listen to a Weather Broadcast Channel (Example: When “WX” is assigned to [P4]):

1. Press the Microphone **[P4]** key to recall the Weather Broadcast channels.
Turn the **DIAL** knob to select the desired Weather Broadcast channel.

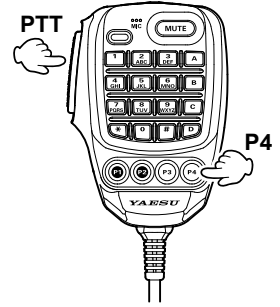

CH	Frequency	CH	Frequency
1	162.550MHz	6	162.500MHz
2	162.400MHz	7	162.525MHz
3	162.475MHz	8	161.650MHz
4	162.425MHz	9	161.775MHz
5	162.450MHz	10	163.275MHz

 In the USA model, the **[P4]** key one of the programmable keys, is assigned (default setting) as the “WX Broadcast” one-touch access key. Please note that if you change/assign another function to the **[P4]** key, one-touch access to the WX channel will be unavailable.

2. To scan the other channels for activity, press the Microphone **PTT** switch.
3. To exit to normal operation, press the **[P4]** key again. Operation will return to the VFO or Memory channel in operation before you began Weather Broadcast operation.

Severe Weather Alert Feature

In the event of extreme weather disturbances, such as storms and hurricanes, NOAA (the National Oceanic and Atmospheric Administration) sends a weather alert accompanied by a 1050Hz tone and subsequent weather report on one of the NOAA weather channels. You may enable this feature via Setup Menu Item **[39 WX ALERT]** see page 32 for details.



For additional details on the following Functions, refer to the Advanced Manual which may be downloaded from the Yaesu website.

Tone squelch feature

The tone squelch opens the speaker audio only when a signal containing the specified **CTCSS** tone is received. By matching the **CTCSS** tone frequency with the partner stations, quiet standby monitoring is possible.

Digital Code squelch (DCS) feature

The **DCS** (Digital Coded Squelch) function allows audio to be heard only when signals containing the same **DCS** code are received.

New PAGER (EPCS) feature

This new feature allows calling specified stations only, by using a pager code that combines two **CTCSS** tones. Even when the person who is called is not near the transceiver, the information is displayed on the LCD to indicate that a call was received. When the call is received, the bell sounds.

Using Setup Menu

The Set Mode permits configuring the various functions to accommodate individual operating needs and preferences.

Setup Menu Operation

1. Press and hold the  key.

The SETUP MENU screen will be displayed.

2. Rotate the Right **DIAL** knob to select the desired item in the Setup Menu, then press the Right **DIAL** knob.

- Press the  key to return to the previous screen.
- Rotate the Left **DIAL** knob, or press the [UP] / [DWN] key on the microphone to scroll through the 12 categories in the Setup Menu (See below):

DISPLAY ↔ TX ↔ RX ↔ **MEMORY** ↔ **CONFIG** ↔

↔ **AUDIO** ↔ **SIGNALING** ↔ **SCAN** ↔ **DATA** ↔

↔ **SD CARD** ↔ **OPTION** ↔ **CLONE/RESET**

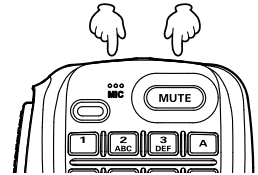
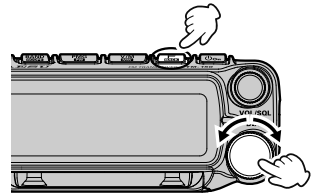
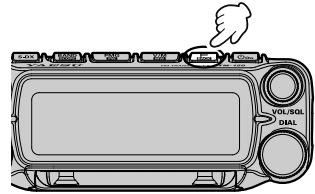

3. Press the Right **DIAL** knob.
4. When there is no deeper level of menu items, go to step 5.
When there is a deeper level of menu items, press the Right **DIAL** knob to select the desired item, then press the Right **DIAL** knob.
5. Rotate the Right **DIAL** knob to change the setting value.
6. Press any key or **DIAL** knob, other than the Right **DIAL** knob or  key, to return to the normal operation.

Tables of Setup Menu Operations

Menu Number / Item	Description	Selectable options (Options in bold are the default settings)
--------------------	-------------	--

DISPLAY

1 KEYPAD	Enter frequency directly or display memory channel list.	-
2 LCD DIMMER	Sets the display and key button brightness.	MAX / MID / OFF
3 LCD CONTRAST	Sets the screen contrast.	1 - 5 - 9
4 BAND SCOPE	Scope Display width setting.	WIDE / NARROW
5 S-METER SYMBOL	Selects the S- & TX PO meter Symbol.	
6 BACKLIGHT COLOR	Set the display color.	AMBER / WHITE

TX

7 TX POWER	Set the transmit power level.	LOW / MID / HIGH
8 MIC GAIN	Microphone sensitivity setting.	MIN / LOW / NORMAL / HIGH / MAX
9 VOX	VOX function settings.	VOX: OFF / LOW / HIGH DELAY: 0.5s / 1.0s / 1.5s / 2.0s / 2.5s / 3.0s VOX MIC: FRONT / REAR
10 AUTO DIALER	DTMF code automatic transmit setting.	ON / OFF
11 TOT	TX time out setting.	OFF / 1min / 2min / 3min / 5min / 10min / 15min / 20min / 30min (3min: USA version)

RX

12 FM BANDWIDTH	Set the FM transmit modulation level.	WIDE / NARROW
13 RX MODE	Select the receive mode.	AUTO / FM / AM
14 SUB BAND		
SUB BAND	Sub Band ON/OFF.	OFF / ON
SUBBAND MUTE	Sub Band mute setting	OFF / ON

MEMORY

15 HOME CH	Recall the home channel.	-
16 MEMORY LIST	Displays the Memory channel list screen.	-
17 MEMORY LIST MODE	Displays a list of memory channels in memory mode.	ON / OFF
18 PMG		
PMG TIMER	Scan resume time after there is no signal when receiving in PMG mode simultaneously.	0.5sec / 1sec / 2sec
PMG CLEAR	Cancel the registration of all PMG channels.	-

CONFIG

19 BEEP	Beep volume setting.	OFF / LOW / HIGH
20 BAND SKIP	Set the frequency bands that can be selected.	AIR: ON / OFF VHF: ON / OFF UHF: ON / OFF OTHER: ON / OFF
21 RPT ARS	Repeater auto shift setting.	OFF / AUTO
22 RPT SHIFT	Repeater shift direction setting.	AUTO / -RPT / +RPT
23 RPT SHIFT FREQ	Repeater TX offset setting.	0.00MHz to 99.95MHz
24 RPT REVERSE	Reverses the transmit and receive frequencies while working through a repeater.	NORMAL / REVERSE

Menu Number / Item	Description	Selectable options (Options in bold are the default settings)
25 MIC PROGRAM KEY	Microphone P1 / P2 / P3 / P4 keys programmable settings.	OFF / 2nd PTT / SCAN / HOME CH / RPT SHIFT / REVERSE / TX POWER / SQL OFF / T-CALL / VOICE* / WX / DW (*requires optional FVS-2) P1: 2nd PTT P2: HOME CH P3: TX POWER P4: WX (T-CALL: European version)
26 STEP	Frequency tuning step.	AUTO / 5.00 kHz / 6.25 kHz / (8.33 kHz) / 10.00 kHz / 12.50 kHz / 15.00kHz / 20.00kHz / 25.00 kHz / 50.00 kHz / 100 kHz (8.33kHz: only for Air band)
27 CLOCK TYPE	Clock shift setting.	A / B
28 APO	Automatic power OFF time setting.	OFF / 0.5hour to 2.0hour (0.5 hour steps) / 2.0hour to 12.0hour (1.0 hour steps)

AUDIO		
29 REAR SP OUT	Output level of the main body speaker	0% to 100%
30 FRONT SP MUTE	Front speaker operation settings when external speakers are connected.	CONTINUE / AUTO MUTE

SIGNALING		
31 DTMF	Load DTMF Autodialer Memories.	-
32 DTMF MEMORY	Set the DTMF auto dialer channel and code (16 characters).	1 to 9
33 SQL TYPE	Select a squelch type.	OFF / TONE ENC / TONE SQL / REV TONE / DCS / PR FREQ / PAGER / (DCS ENC) / (TONE DCS) / (DCS TSQ) *The options in the parentheses are available when the SQL expansion is ON.
34 TONE SQL FREQ or DCS CODE	Set the CTCSS Tone Frequency or the DCS code.	CTCSS: 67.0Hz to 254.1Hz (100Hz) DCS: 023 to 754
35 SQL EXPANSION	Separate squelch type setting for transmit and receive.	ON / OFF
36 PAGER CODE	Pager individual code settings.	RX-CODE 1: 01 - 05 - 50 RX-CODE 2: 01 - 47 - 50 TX-CODE 1: 01 - 05 - 50 TX-CODE 2: 01 - 47 - 50
37 PR FREQUENCY	User programmed reverse tone frequency.	300Hz - 1500Hz - 3000Hz
38 BELL RINGER	Recall sound length setting.	OFF / 1 time / 3 times / 5 times / 8 times / CONTINUOUS
39 WX ALERT	Weather alert operation setting.	ON / OFF

SCAN		
40 SCAN	Engages the Scan operation.	-
41 DUAL RECEIVE MODE	Dual receive operation setting.	OFF / PRIORITY SCAN
42 DUAL RX INTERVAL	Dual receive reception interval setting. (Only enabled when "41 DUAL RECEIVE MODE" is set to "PRIORITY SCAN".)	0.5sec / 1.0sec / 2.0sec / 3.0sec / 5.0sec / 7.0sec / 10sec
43 PRIORITY REVERT	The transmission operation during dual receive always transmits on the home channel.	OFF / ON
44 SCAN RESUME	Set the resume operation after scanning stops on a signal.	BUSY / HOLD / 1sec / 3sec / 5sec

Menu Number / Item	Description	Selectable options (Options in bold are the default settings)
--------------------	-------------	--

DATA

45 DATA BAND	DATA band selection settings.	MAIN BAND / SUB BAND / A-BAND FIX / B-BAND FIX
46 DATA SPEED	DATA communication baud rate settings.	1200 bps / 9600 bps

SD CARD

47 BACKUP		
WRITE TO SD	Saves the transceiver setting information to a microSD memory card.	
ALL MEMORY SETUP	Copies all data. Copies only the memory channels. Copies only the set-up menu settings.	
READ FROM SD	Loads the information to the transceiver from a microSD memory card.	
ALL MEMORY SETUP	Copies all data. Copies only the memory channels. Copies only the set-up menu settings.	
48 SD INFORMATION	Displays the total capacity and free space of the microSD Card.	–
49 SD FORMAT	Initializing the micro-SD card.	–

OPTION

50 Bluetooth (Requires optional Bluetooth® Unit BU-5)		
Bluetooth	Bluetooth headset setting.	OFF / ON
DEVICE	Bluetooth device list.	–
AUDIO	Set whether received audio is heard from both the Bluetooth® headset and the transceiver speaker, or only from the connected Bluetooth® device.	AUTO / FIX
51 VOICE MEMORY (Requires optional Voice Guide Unit FVS-2)		
PLAY/REC	Recording operation settings.	FREE 5min / LAST 30sec
ANNOUNCE	Setting conditions for frequency announcement.	OFF / MANUAL / AUTO
LANGUAGE	Setting the language to announce.	ENGLISH / JAPANESE
VOLUME	Setting the announcement volume.	HIGH / MID / LOW
RX MUTE	Setting to mute received audio during announcements and playback.	ON / OFF
52 FVS REC	Start recording the received audio.	–
53 TRACK SELECT	Selecting the audio track to play.	ALL / 1 - 8
54 FVS PLAY	Start playing the recorded sound	–
55 FVS STOP	Stop recording / playing	–
56 FVS CLEAR	Erase all recorded audio	–
57 VOICE GUIDE	The frequency of the operating band will be announced.	–

CLONE/RESET

58 This → Other	Send all settings to other FTM-150R/E	–
59 Other → This	Receive all settings from other FTM-150R/E	–
60 SOFTWARE VERSION	Display the software version.	Main Ver. / Sub Ver.
61 MEMORY CH RESET	Erase registered memory channels.	–
62 FACTORY RESET	Return all settings to factory default.	–

Restoring to Defaults (Reset)

Caution

When the All Reset function is performed, all data registered in the memory will be deleted. Be sure to note the settings on paper or back up the data on a microSD memory card.

All Reset

To restore all transceiver settings and memory content to the factory defaults.

1. Press and hold the  key.
The SETUP MENU screen will be displayed.
2. Rotate the the Right **DIAL** knob to select [**62 FACTORY RESET**], then press the Right **DIAL** knob.
“FACTORY RESET” appears on the LCD.
3. Rotate the Right **DIAL** knob to select [**OK**].
To cancel the resetting, select [**CANCEL**], then press the Right **DIAL** knob.
4. Press the Right **DIAL** knob to reset all.

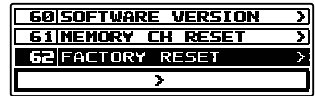
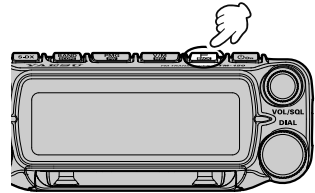

Memory Channels Reset

To erase only the registered all memory channels.

1. Press and hold the  key.
The SETUP MENU screen will be displayed.
2. Rotate the the Right **DIAL** knob to select [**61 MEMORY CH RESET**], then press the Right **DIAL** knob.
“MEMORY CH RESET” appears on the LCD.
3. Rotate the Right **DIAL** knob to select [**OK**].
To cancel the resetting, select [**CANCEL**], then press the Right **DIAL** knob.
4. Press the Right **DIAL** knob to delete all memory contents.

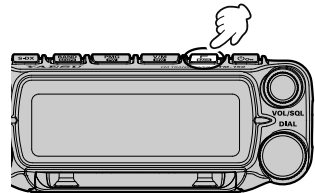

Text input screen

The keyboard screen is displayed when entering memory channel tag.

● Character input method

1. Rotate the Right **DIAL** knob to select a character, then press the Right **DIAL** knob.
2. The selected character is entered and the cursor moves right in the text input area.
3. Repeat steps 1 to enter additional characters.
4. When input is complete, press and hold the Right **DIAL** knob to save the characters.

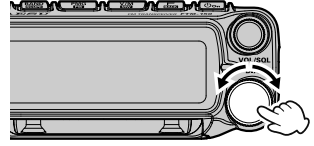

abc / **ABC** : displays the alphabet keypad input screen.

123 : displays the numeric keypad input screen.

#%^ : displays the symbols keypad input screen.

← : moves the cursor to the left.

␣ : enter a space at the cursor position.

→ : moves the cursor to the right.

⌫ : erases the character to the left of the cursor and moves the cursor to the left.

Alphabet Input

Rotate the Right **DIAL** knob to select **ABC** or **abc**, and each time the Right **DIAL** knob is pressed, the input switches between capital and small letters.

1 byte letters



2 byte letters



Numbers and Symbols Input

Rotate the Right **DIAL** knob to select **123**, then press the Right **DIAL** knob.



Symbols Input

Rotate the Right **DIAL** knob to select **#%^**, then press the Right **DIAL** knob.

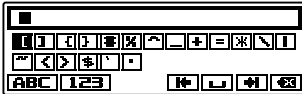

Specifications

● General

Frequency Range	: TX 144 - 148MHz or 144 - 146MHz 430 - 450MHz or 430 - 440MHz (Depends on the transceiver version)
	: RX 108 - 137MHz (AIR Band) 137 - 174MHz (144MHz HAM / VHF Band) 174 - 400MHz (VHF Band / UHF Band) 400 - 550MHz (430MHz HAM / UHF Band)
Channel Steps	: 5 / 6.25 / 8.33 / 10 / 12.5 / 15 / 20 / 25 / 50 / 100kHz (8.33kHz: only for Air band)
Mode of Emission	: F2D, F3E
Frequency Stability	: ± 2.5 ppm (-4°F to +140°F [-20°C to +60°C])
Antenna Impedance	: 50 Ω
Supply Voltage	: Nominal 13.8V DC, negative ground
Current Consumption (approx.)	: 0.5A (Receive) 11A (55W TX, 144MHz) 10A (50W TX, 430MHz)
Operating Temperature Range	: -4°F to +140°F (-20°C to +60°C)
Case Size (W x H x D)	: Radio unit 5.47" x 1.66" x 5.23" (139 x 42 x 133mm) (w/o Fan) Controller 5.82" x 2.2" x 2.2" (148 x 56 x 56mm) (w/o Knob)
Weight (approx.)	: 2.64lbs (1.2kg) (with Radio Unit, Controller, Control Cable)

● Transmitter

RF Power Output	: 55W (144MHz), 50W (430MHz) / 25W / 5W
Modulation Type	: F2D, F3E: Variable Reactance Modulation
Maximum Deviation	: ± 5 kHz
Spurious Emission	: At least 60dB below
Microphone Impedance	: 2k Ω
DATA Jack Impedance	: 10k Ω

● Receiver

Circuit Type	: Double-Conversion Super heterodyne
Intermediate Frequency	: 1st: MAIN Band 56.75MHz 1st: SUB Band 55.85MHz 2nd: MAIN Band, SUB Band 450kHz
Sensitivity	: 0.8 μ V typ for 10dB SN (108 - 137MHz, @AM) 0.2 μ V for 12dB SINAD (137 - 140MHz, @FM) 0.2 μ V for 12dB SINAD (140 - 150MHz, @FM) 0.25 μ V for 12dB SINAD (150 - 174MHz, @FM) 0.3 μ V typ for 12dB SINAD (174 - 222MHz, @FM) 0.25 μ V typ for 12dB SINAD (222 - 300MHz, @FM) 0.8 μ V typ for 10dB SN (300 - 336MHz, @AM) 0.25 μ V typ for 12dB SINAD (336 - 420MHz, @FM) 0.2 μ V for 12dB SINAD (420 - 470MHz, @FM) 0.2 μ V typ for 12dB SINAD (470 - 550MHz, @FM)
Selectivity (-6 dB/-60 dB)	: NFM, AM 12 kHz / 30 kHz
AF Output	: 3W (8 Ω , THD10%, 13.8 V) Front Speaker 3W (8 Ω , THD10%, 13.8 V) Internal Speaker 3W (8 Ω , THD10%, 13.8 V) External Speaker
AF Output Impedance	: 8 Ω
Strength of secondary radio waves	: 4 nW and below

Specifications are subject to change without notice, and are guaranteed within the 144/430MHz amateur bands only.

About internal spurious signals

Certain frequency combinations of signals received simultaneously, may cause some effect on the receiver mixer and IF circuits due to the high frequency of the internal oscillator. However, this is not a malfunction (refer to the calculation formulas below: n is any integer). Depending on the combination of the frequencies received at the same time, there may also be fluctuations in the receiver sensitivity.

- Reception frequency = 16MHz x n times
- Reception frequency = 12MHz x n times
- Reception frequency = 56.3MHz x n times
- Reception frequency = 45.9MHz x n times
- MAIN Band frequency = (SUB Band frequency \pm 55.85MHz) \times n times
- SUB Band frequency = (MAIN Band frequency \pm 56.75MHz) \times n times

YAESU LIMITED WARRANTY

Limited Warranty is valid only in the country/region where this product was originally purchased.

On-line Warranty Registration:

Thank you for buying YAESU products! We are confident your new radio will serve your needs for many years! Please register your product at www.yaesu.com - Owner's Corner

Warranty Terms:

Subject to the Limitations of the Warranty and the Warranty Procedures described below, YAESU MUSEN hereby warrants this product to be free of defects in materials and workmanship in normal use during the "Warranty Period." (the "Limited Warranty").

Limitations of Warranty:

- A. YAESU MUSEN is not liable for any express warranties except the Limited Warranty described above.
- B. The Limited Warranty is extended only to the original end-use purchaser or the person receiving this product as a gift, and shall not be extended to any other person or transferee.
- C. Unless a different warranty period is stated with this YAESU product, the Warranty Period is three years from the date of retail purchase by the original end-use purchaser.
- D. The Limited Warranty is valid only in the country/region where this product was originally purchased.
- E. During the Warranty Period, YAESU MUSEN will, at its sole option, repair or replace (using new or refurbished replacement parts) any defective parts within a reasonable period of time and free of charge.
- F. The Limited Warranty does not cover shipping cost (including transportation and insurance) from you to us, or any import fees, duties or taxes.
- G. The Limited Warranty does not cover any impairment caused by tampering, misuse, failure to follow instructions supplied with the product, unauthorized modifications, or damage to this product for any reasons, such as: accident; excess moisture; lightning; power surges; connection to improper voltage supply; damage caused by inadequate packing or shipping procedures; loss of, damage to or corruption of stored data; product modification to enable operation in another country/purpose other than the country/purpose for which it was designed, manufactured, approved and/or authorized; or the repair of products damaged by these modifications.
- H. The Limited Warranty applies only to the product as it existed at the time of the original purchase, by the original retail purchaser, and shall not preclude YAESU MUSEN from later making any changes in design, adding to, or otherwise improving subsequent versions of this product, or impose upon YAESU MUSEN any obligation to modify or alter this product to conform to such changes, or improvements.
- I. YAESU MUSEN assumes no responsibility for any consequential damages caused by, or arising out of, any such defect in materials or workmanship.
- J. TO THE FULLEST EXTENT PERMITTED BY LAW, YAESU MUSEN SHALL NOT BE RESPONSIBLE FOR ANY IMPLIED WARRANTY WITH RESPECT TO THIS PRODUCT.
- K. If the original retail purchaser timely complies with the Warranty Procedures described below, and YAESU MUSEN elects to send the purchaser a replacement product rather than repair the "original product", then the Limited Warranty shall apply to the replacement product only for the remainder of the original product Warranty Period.
- L. Warranty statutes vary from state to state, or country to country, so some of the above limitations may not apply to your location.

Warranty Procedures:

1. To find the Authorized YAESU Service Center in your country/region, visit www.yaesu.com. Contact the YAESU Service Center for specific return and shipping instructions, or contact an authorized YAESU dealer/distributor from whom the product was originally purchased.
2. Include proof of original purchase from an authorized YAESU dealer/distributor, and ship the product, freight prepaid, to the address provided by the YAESU Service Center in your country/region.
3. Upon receipt of this product, returned in accordance with the procedures described above, by the YAESU Authorized Service Center, all reasonable efforts will be expended by YAESU MUSEN to cause this product to conform to its original specifications. YAESU MUSEN will return the repaired product (or a replacement product) free of charge to the original purchaser. The decision to repair or replace this product is the sole discretion of YAESU MUSEN.

Other conditions:

YAESU MUSEN'S MAXIMUM LIABILITY SHALL NOT EXCEED THE ACTUAL PURCHASE PRICE PAID FOR THE PRODUCT. IN NO EVENT SHALL YAESU MUSEN BE LIABLE FOR LOSS OF, DAMAGE TO OR CORRUPTION OF STORED DATA, OR FOR SPECIAL, INCIDENTAL, CONSEQUENTIAL, OR INDIRECT DAMAGES, HOW EVER CAUSED; INCLUDING WITHOUT LIMITATION TO THE REPLACEMENT OF EQUIPMENT AND PROPERTY, AND ANY COSTS OF RECOVERING, PROGRAMMING OR REPRODUCING ANY PROGRAM OR DATA STORED IN OR USED WITH THE YAESU PRODUCT.

Some Countries in Europe and some States of the USA do not allow the exclusion or limitation of incidental or consequential damages, or a limitation on how long an implied warranty lasts, so the above limitation or exclusions may not apply. This warranty provides specific rights, there may be other rights available which may vary between countries in Europe or from state to state within the USA.

This Limited Warranty is void if the label bearing the serial number has been removed or defaced.

Changes or modifications to this device that are not expressly approved by YAESU MUSEN could void the user's authorization to operate this device.

This device complies with part 15 of the FCC Rules. Operation is subject to the following two conditions: (1) This device may not cause harmful interference, and (2) this device must accept any interference including received, interference that may cause undesired operation.

The scanning receiver in this equipment is incapable of tuning, or readily being altered, by the User to operate within the frequency bands allocated to the Domestic public Cellular Telecommunications Service in Part 22.

The YAESU MUSEN is not responsible for any changes or modifications not expressly approved by the party responsible for compliance. Such modifications could void the user's authority to operate the equipment.

DECLARATION BY MANUFACTURER

The Scanner receiver is not a digital scanner and is incapable of being converted or modified to a digital scanner receiver by any user.

WARNING: MODIFICATION OF THIS DEVICE TO RECEIVE CELLULAR RADIOTELEPHONE SERVICE SIGNALS IS PROHIBITED UNDER FCC RULES AND FEDERAL LAW.

CAN ICES-3 (B) / NMB-3 (B)

This equipment has been tested and found to comply with the limits for a Class B digital device, pursuant to part 15 of the FCC Rules. These limits are designed to provide reasonable protection against harmful interference in a residential installation. This equipment generates, uses, and can radiate radio frequency energy; and, if not installed and used in accordance with the instructions, may cause harmful interference to radio communications. However, there is no guarantee that interference will not occur in a particular installation.

If this equipment does cause harmful interference to radio or television reception, which can be determined by turning the equipment off and on, the user is encouraged to try to correct the interference by one or more of the following measures:

- Reorient or relocate the receiving antenna.
- Increase the separation between the equipment and receiver.
- Connect the equipment into an outlet on a circuit different from that to which the receiver is connected.
- Consult the dealer or an experienced radio/TV technician for help.

This equipment complies with FCC/IC radiation exposure limits and meets the FCC radio frequency (RF) Exposure Guidelines and RSS-102 of the IC radio frequency (RF) Exposure rules. This equipment has very low levels of RF energy that is deemed to comply without testing of specific absorption rate (SAR).

This transmitter must not be co-located or operated in conjunction with any other antenna or transmitter.

YAESU

Declaration of Conformity

Type of Equipment: 144/430MHz Digital/Analog Transceiver
Brand Name: YAESU
Model Number: FTM-150R
Manufacturer: YAESU MUSEN CO., LTD.
Address of Manufacturer: Omori Bell port D building 3F, 6-26-3 Minamioi,
Shinagawa-ku, Tokyo 140-0013 JAPAN

This device complies with part 15 of the FCC Rules. Operation is subject to the following two conditions; (1) this device may not cause harmful interference, and (2) this device must accept any interference received, including interference that may cause undesired operation.

The technical documentation as required by the Conformity Assessment procedures is kept at the following address:

Company: Yaesu U.S.A.
Address: 6125 Phyllis Drive, Cypress, CA 90630, U.S.A.
Telephone: (714) 827-7600

EU Declaration of Conformity

We, Yaesu Musen Co. Ltd of Tokyo, Japan, hereby declare that this radio equipment FTM-150E is in full compliance with EU Radio Equipment Directive 2014/53/EU. The full text of the Declaration of Conformity for this product is available to view at <http://www.yaesu.com/jp/red>

ATTENTION – Condition of use

This transceiver operates on frequencies that are regulated. Use of the Transmitter in the EU countries shown in the accompanying table is not permitted without authorization. Users should consult their local spectrum management authority for licensing conditions applicable to this equipment.

					
AT	BE	BG	CY	CZ	DE
DK	ES	EE	FI	FR	EL
HR	HU	IE	IT	LT	LU
LV	MT	NL	PL	PT	RO
SK	SI	SE	CH	IS	LI
NO	-	-	-	-	-

Disposal of Electronic and Electrical Equipment

Products with the symbol (crossed-out wheeled bin) cannot be disposed as household waste.

Electronic and Electrical Equipment should be recycled at a facility capable of handling these items and their waste by-products.

Please contact a local equipment supplier representative or service center for information about the waste collection system in your country.



YAESU

Radio for Professionals

Copyright 2024
YAESU MUSEN CO., LTD.
All rights reserved.

No portion of this manual may be
reproduced without the permission of
YAESU MUSEN CO., LTD.

YAESU MUSEN CO., LTD.

Omori Bellport Building D-3F
6-26-3 Minami-Oi, Shinagawa-ku, Tokyo, 140-0013, Japan

YAESU USA

6125 Phyllis Drive, Cypress, CA 90630, U.S.A.

YAESU UK

Unit 4, Concorde Park, Concorde Way, Segensworth North,
Fareham, Hampshire PO15 5FG, United Kingdom

2411F-CS
Printed in Japan

