

YAESU
The radio

C4FM/FM 144/430MHz
DUAL BAND DIGITAL TRANSCEIVER

FTM-200DR

FTM-200DE

Operating Manual



Contents

Introduction	1	Recalling the Home Channels	42
Quick Guide	2	Changing the Home Channel Frequency	43
Supplied Accessories and Options	3	Split Memory	43
Supplied Accessories	3	PMG-SR (Single Receiver Primary	
Available Options	3	Memory Group) Activity Monitor ...	45
Basic Operation	4	Register the frequency to PMG	45
Turning the Transceiver ON	4	Call up the PMG screen	45
Adjusting the volume	5	Switch between Auto Mode and Manual Mode	46
Adjusting the squelch level	5	Auto Mode	46
Selecting a Frequency Band	5	Operation of Auto Mode	46
Tuning to a Frequency	6	Manual Mode	47
Changing the operation band	7	Operation of Manual Mode	47
Transmitting	7	Unregister the channel (frequency) registered in PMG	47
Locking the Keys and DIAL knob	7	Scanning Function	48
Useful Functions	8	VFO Scan / Memory Scan	48
1 CFL: Custom Function List	8	Setting the Receive Operation When Scanning Stops	48
2 PMG-SR (Single Receiver Primary Memory		Skip Memory Channels	49
Group Activity Monitor)	9	Programmable Memory scan (PMS)	49
3 Band Scope	10	Convenience Features	50
4 Memory auto grouping (MAG) function	10	Bluetooth® Operation	50
5 VFO Band skip function	10	Installing the Bluetooth® unit "BU-4"	50
6 Memory channel → VFO copy	10	Pairing the Bluetooth® Headset	51
Setup Menu List	11	Activate Transmit by pressing the button on the Bluetooth®	
Name and function of each component	12	headset (when the VOX function is OFF)	52
Panel (front)	12	Hands-free VOX operation with a Bluetooth® headset	52
Panel (Left and right side)	14	VOX Operation	53
Panel (rear)	14	Setting VOX function	53
Main body (Front)	15	Set the VOX (Voice Operated Transmit) delay time	54
Main body (rear)	15	Bluetooth® battery save function	54
Microphone (SSM-85D)	16	Connect with another Bluetooth® headset	55
Display	18	Bluetooth® received audio output	56
Descriptions of Main Screens	20	Band Scope	57
Safety Precautions (Be Sure to Read)	23	Dual Receive Function	58
Installing the Radio	25	Priority Scan	58
About the antenna	25	A-B Dual Receive	58
Connection of Antenna and Power Cables	25	Using the Voice Recorder	59
Installing the transceiver	26	Recording the receive audio	59
Connecting the front panel to the main body	26	Setting the Recording function	60
Using a Micro SD Memory Card	27	Playback the recorded audio	61
Functions to use as needed	28	Taking a Picture (Snapshot Function)	62
Selecting the Communication Mode	28	Taking pictures	63
Fixing the Communication Mode	29	Viewing the Saved Image	63
Changing the Transmit Power Level	29	Deleting saved images	64
Setting the Skip Band	30	Edit the tag (display name) of the saved image	64
Changing the Frequency Step	30	GPS Function	64
Change the frequency display color of the operation band	30	WIRES-X function	64
Custom Function List	31	APRS function	64
Use the Function List	31	Digital Personal ID (DP-ID) feature	65
Registration to the Function List	32	Tone squelch feature	65
Cancel registration in the Function List	32	Digital Code squelch (DCS) feature	65
Using the convenient Digital C4FM features ...	33	New PAGER (EPCS) feature	65
About the Digital Group ID (DG-ID) feature	33	Using Setup Menu	66
Repeater Operation	36	Tables of Setup Menu Operations	67
Using the Memory	37	Restoring to Defaults (Reset)	75
Writing to memory	37	All Reset	75
Recall memory (There are three ways)	38	Memory Channels Reset	75
Recall only memories in the same frequency band		APRS Reset	75
using the memory auto grouping (MAG) function	40	Text input screen	76
Edit memory	41	Specifications	77

Features of the Yaesu FTM-200DR/DE Transceiver.

- Digital communication using Yaesu (C4FM (Quaternary FSK) system)
- Equipped with AMS (Automatic Mode Select) feature that automatically selects the analog FM or the C4FM digital modes, according to the signal of the other station.
- The Custom Function List (CFL) can be personalized by registering frequently used functions (up to 8) from the 124 items Setup Menu. Functions and setting values are then displayed in a list with one-touch operation of the [F MENU] key. Or you can easily select and use the function with the **DIAL** knob.
- The Single Receiver Primary Memory Group Activity Monitor (PMG-SR) function can register up to 5 channels with the receive frequencies of the VFO or memory channels by simply pressing and holding the [PMG PW] key. Press the [PMG PW] key to scan the registered frequencies and display the reception status (signal strength) in a real time bar graph. In auto mode, any channel with a signal is automatically stopped and received. When operating on the currently selected channel, you can press the PTT key or press the dial to switch to manual mode and fix the channel for communication. When there is no signal in the selected channel, it scans again and displays the reception status (signal strength) in real time.
- With Memory Channel Band Auto Grouping (MAG). The memory channels are automatically categorized in each band, so that memory channels can be quickly recalled.
- The DG-ID (Digital Group ID) feature, and the Group Monitor (GM) feature enable automatically locating, and communicating with other stations that are within contact range and have the matching DG-ID number, (00 to 99).
- Two-inch QVGA full-color TFT display with high-brightness and wide viewing angle.
- Wide-band reception (108 MHz to 999.99 MHz) (USA Cellular Blocked)
- Built-in GPS unit permits display of the current location and heading information
- Installation of the optional Bluetooth® BU-4 unit permits hands-free communication using the optional Bluetooth® headset SSM-BT10 or a commercially available product.
- Large-capacity 1104 memory channels
- 3W Audio Power Speaker with a jack for the optional external speaker
- Heavy Duty-Heat Sink with FACC (Funnel Air-Convection Conductor)
- High speed band scope that displays 61 channels
- Smart Navigation function
- Snapshot function (optional camera/microphone MH-85A11U is required)
- WIRES-X Portable Digital Node or Fixed Node with HRI-200
- Equipped with digital GM (Group Monitor) function
- Ready for APRS® communication with world standard 1200 / 9600bps AX25 modem
- Digital Personal ID (DP-ID) feature
- Compatible with microSD memory cards

Thank you for purchasing the FTM-200DR/DE Transceiver. We urge you to read this manual in its entirety, and also the Advance Manual (available for download on the Yaesu website), to gain a full understanding of the amazing capability of the exciting new FTM-200DR/DE Transceiver.

WIRES-X, GM function and APRS instruction manuals are not included in the product package. They are available and may be downloaded from the Yaesu.com website.

Quick Guide

① Turn the Power ON

Press and hold the [POWER (LOCK)] switch.

② Input the Call sign

When turning the power ON for the first time after purchasing, input the call sign of your own station.

Input call sign may be changed from the Setup Menu [118 CALLSIGN].

1. When turning the power ON for the first time after purchasing, the call sign input screen will be displayed.

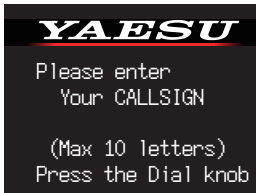

2. Press the **DIAL** knob.



3. Input the call sign.

Rotate the **DIAL** knob to select each character and then press the **DIAL** knob.

: to move the cursor to the right

: to move the cursor to the left

: change to the numeric and symbol input

: change to character input

: delete the character left of the cursor

See "Text input screen" on page 76 to input a call sign.

4. Repeat step 3 to input the remaining call sign characters.
5. Press and hold the **DIAL** knob to conclude inputting.
Normal operation (VFO Mode) screen will be displayed.

③ Select the Operating Band

Press the [BAND GRP] key.

④ Tune the frequency

Rotate the **DIAL** knob.

⑤ Adjust the volume

Rotate the **VOL** knob to adjust the volume to a comfortable level.

⑥ Adjust the squelch setting

The squelch level may be adjusted to mute the background noise when no signal is received

1. Press the [SQL BACK] key.
2. Rotate the **DIAL** knob to adjust the squelch to a level at which the background noise is muted.

* When the squelch level is increased, the noise is more likely to be silenced, but it may become more difficult to receive weak signals.

3. Press the [SQL BACK] key again or wait for about 3 seconds to conclude the adjustment.

⑦ Select the communication mode

In the factory settings, the communication mode automatically corresponds to the signal being received.

* Touch [D X] key to manually select the communication mode. Refer to "Fixing the Communication Mode" on page 29 for setting.

⑧ Transmit/Receive Signals

Talk into the microphone while holding the **PTT** switch on the side. Release the **PTT** switch to return to receive.

⑨ Set the Bluetooth® function

The FTM-200D supports Bluetooth® function. (Requires optional BU-4) To use a Bluetooth® headset, refer to "Bluetooth® Operation" (page 50) for settings.

Supplied Accessories and Options

Supplied Accessories

- DTMF microphone SSM-85D
- DC power cable (with fuse attached)
- Control cable
- Control cable 10ft (3m)
- Bracket for main body (with mounting screws)
- Bracket for the controller
- Mic hanger (with mounting screws)
- USB Cable
- Spare fuse (15A) x2
- Operating Manual (This Manual)



If any item is missing, contact the dealer from which you purchased the transceiver.

Available Options

- | | |
|--|-----------|
| • Microphone with Snapshot Camera | MH-85A11U |
| • DTMF Microphone | SSM-85D |
| • Microphone | MH-42C6J |
| • Bluetooth® Headset | SSM-BT10 |
| • Bluetooth® Unit | BU-4 |
| • High-Power External Speaker | MLS-100 |
| • Voice Guide Unit | FVS-2 |
| • Vacuum Cup Mount Bracket for Front Panel Controller | MMB-98 |
| • Mic Extension Cable 10ft (3m) for MH-85A11U | SCU-23 |
| • Mic Extension Kit 10ft (3m) for SSM-85D and MH-42C6J | MEK-5 |
| • Control Cable 20ft (6m) | SCU-47 |
| • Cloning Cable | CT-166 |
| • WIRES-X Connection Cable kit | SCU-40 |
| • Data Cable (MDIN10 pin to MDIN6 pin + Dsub9) | CT-163 |
| • Data Cable (MDIN10 pin to MDIN6 pin) | CT-164 |
| • Data Cable (MDIN10 pin to Open) | CT-167 |

Basic Operation

Turning the Transceiver ON

1. Press and hold the **POWER (LOCK)** switch to turn the transceiver **ON / OFF**.

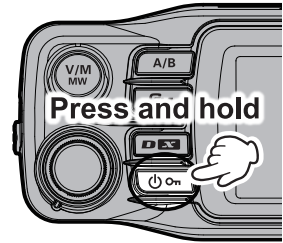

● Inputting the call sign

1. The first time the transceiver is turned ON after it is purchased; input your own call sign.
2. Press the **DIAL** knob to proceed to the call sign input screen.
 - When the transceiver is subsequently turned ON, the opening screen appears followed by the frequency screen.
 - The input call sign may be changed from the Setup Menu [**118 CALLSIGN**].
3. Rotate the **DIAL** knob, then press it to select each character.

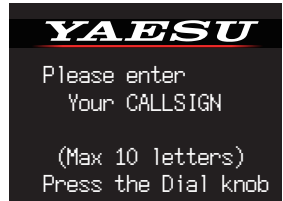

- : to move the cursor to the right.
- : to move the cursor to the left.
- : change to the numeric and symbol input
- : delete the character left of the cursor

Up to 10 characters (letters, numbers, and a hyphen) can be entered.

4. Repeat step 3 to input the remaining call sign characters.
5. Press and hold the **DIAL** knob to conclude inputting. Normal operating (VFO Mode) screen will be displayed.

Adjusting the volume

1. Rotate the **VOL** knob to adjust the volume to a comfortable level.

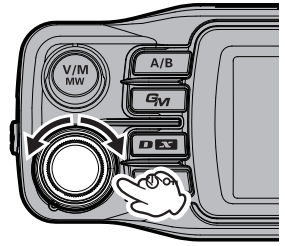

Adjusting the squelch level

Annoying noises can be muted when a signal cannot be detected. Normally, use the factory settings, but adjust the squelch if noise is harsh.

1. Press the **[SQL BACK]** key, and then rotate the **DIAL** knob to adjust to a level at which the background noise is muted.
 - **SQL**  appears on the display.
 - Adjustment is possible for A band and B band.
2. After the adjustment, press the **[SQL BACK]** key again, or do nothing for about 3 seconds, the SQL meter will return to the VOL meter.

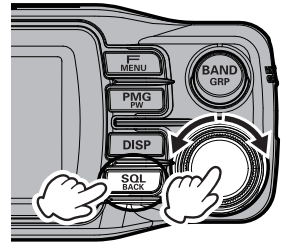

When the squelch level is increased, the noise is more likely to be silenced, but it may become more difficult to receive weak signals.

Selecting a Frequency Band

Press the **[BAND GRP]** key to select the desired frequency band.

AIR Band	108MHz - 137MHz
144MHz Band	137MHz - 174MHz
VHF Band	174MHz - 400MHz
430MHz Band	400MHz - 480MHz
UHF Band	480MHz - 999.99MHz

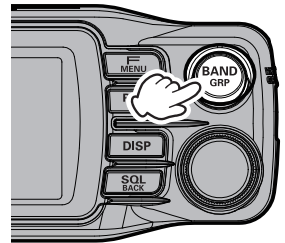

- With the “band skip function”, specific bands may be selected to be used. Even when the band skip is set so that some frequencies cannot be selected, frequently used frequencies can be recalled by saving them into the memory channels before setting band skip.
- In the VFO mode, press and hold the **[BAND GRP]** key → rotate the **DIAL** knob to select the band to set → press the **DIAL** knob to select the band → rotate the **DIAL** knob to select “ON” (selectable) or “OFF” (not selectable)

Tuning to a Frequency

● DIAL knob

Rotate the **DIAL** knob change the frequency in the default frequency steps for the current frequency band.

Change frequency in 1MHz steps

Press the **DIAL** knob, and then rotate the **DIAL** knob.

Change frequency in 5MHz steps

Press and hold the **DIAL** knob, and then rotate the **DIAL** knob.

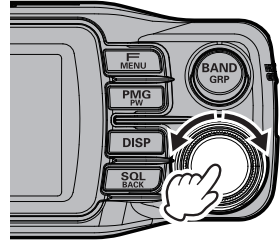

● Frequency input screen

1. In VFO mode, press the **[F MENU]** key.
2. Press the **DIAL** knob.
 - Or press and hold the **[F MENU]** key → **[1 FREQUENCY INPUT]**.
 - The frequency input screen appears.
3. Rotate the **DIAL** knob to select a digit and press the **DIAL** knob.
4. Repeat step 3 to input the remaining frequency digits.

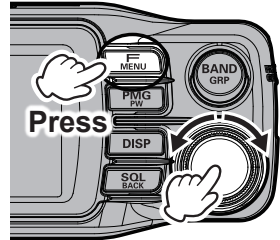

- Press and hold the DIAL knob while inputting the frequency to conclude the input and confirm the frequency.
- Pressing the **[F MENU]** key, **[BACK]** key or **PTT** while inputting the frequency cancels the input and returns to the operation screen.

● The numeric keys on microphone

Press the numeric keys "0" to "9" to enter the frequency.

Example: To input 145.520 MHz

[1] → [4] → [5] → [5] → [2]

Example: To input 430.000 MHz

[4] → [3] → [Press and hold any numeric key]



While entering a frequency using the numeric keys, the entry may be canceled by pressing **PTT**.



Changing the operation band

Two operational bands are displayed on the top and bottom. The upper display band can be changed by operating the frequency and radio wave format.

1. Each time the **[A/B]** key is pressed, the operating band switches between “A band” and “B band”.
The upper display is called the “operating band”, and the lower display is called the “sub band”.

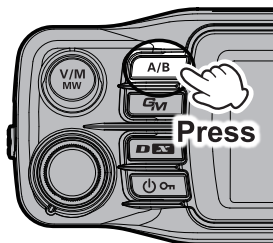

! The operating band signals and sub-band signals cannot be received simultaneously.

Transmitting

1. While pressing and holding **PTT**, speak into the microphone.
2. Release the PTT to return to receive. The receive mode is indicated by the color of the Status Indicator light on the display.

DIGITAL		ANALOG	
TX	RX	TX	RX
Red	Green	Red	Green
Blue	Blue	Red	Green



i In Digital Mode, if a received signal contains a DG-ID different from the DG-ID setting of this transceiver, the upper green and lower blue lights flash. In FM mode, the upper and lower green lights flash when receiving a signal containing a tone or DCS different from the squelch setting of this station.

- If the **PTT** switch is pressed when a frequency other than the amateur ham radio band is selected, an alarm tone (beep) will be emitted, “**TX PROHIBIT**” appears on the display, and transmit is disabled.
- If transmission is continued for a long period, the transceiver overheats, and the high temperature protection function is activated. As a result, the transmitting power level is automatically set to Low Power. If transmission continues while the high temperature protection function is active, the transceiver will be forcibly returned to the receive mode.

Locking the Keys and DIAL knob

1. Press the **[POWER (Lock)]** switch, “**LOCK**” is shown on the display for one second, the “**🔒**” icon appears on the display, and then the keys and **DIAL** knob are locked.
Press the **[POWER (Lock)]** switch again, “**UNLOCK**” will be shown on the Display and the keys and the **DIAL** knob are unlocked.
The “**🔒**” icon disappears.

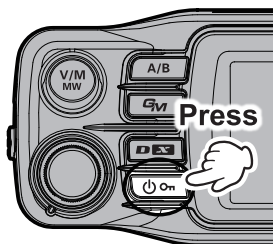

i The **PTT** switch and the VOL knob cannot be locked.

Useful Functions

① CFL: Custom Function List page 31

From 124 items of the Setup Menu (see page 11), frequently used functions in the Function List can be registered and then recalled by simply pressing the [F MENU] key. The Function List screen displays the registered functions and current settings in an easy-to-read form, so you can immediately select and use the function. By default, 10 functions are registered in the Custom Function List. Up to 8 frequently used functions can be registered and customized in the Function List.

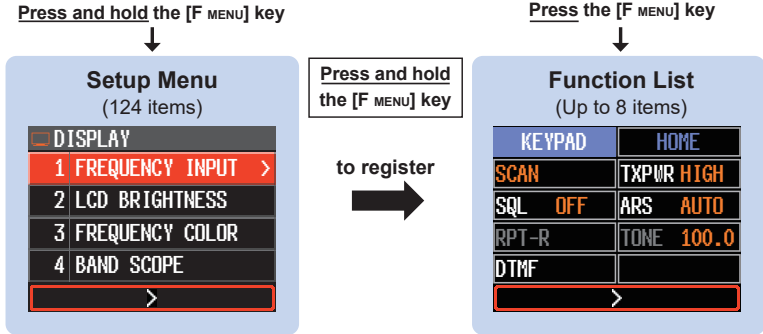

The "KEYPAD" and "HOME" displayed at the top of the screen cannot be changed.

● Registration to the Custom Function List

Press and hold the [F MENU] key to display the setup menu, select the item to be registered with the **DIAL** knob, then press and hold the [F MENU] key.

Select the list position to register the setup item with the **DIAL** knob, and then press the **DIAL** knob to register it in the setup menu.

Press and hold: to register in the function list

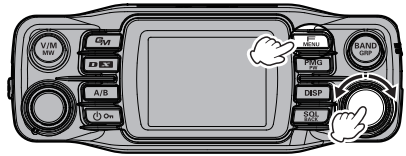

Turn **DIAL** knob to select, then Press **DIAL** knob

● Use the Function List

Press the [F MENU] key to display the function list screen, and select the function to be used with the **DIAL** knob.

By pressing the **DIAL** knob, you can execute functions or change settings.

Press: to recall

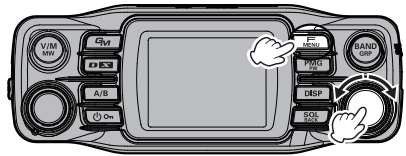

Turn **DIAL** knob to select, then Press **DIAL** knob

● Cancel registration to Function List

On the function list screen, select the function to cancel with the **DIAL** knob.

Press and hold the [SQL BACK] key to cancel the registration.

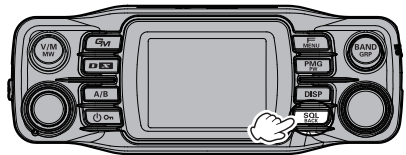

Press and hold: to cancel registration

② PMG-SR (Single Receiver Primary Memory Group Activity Monitor) page 45

The PMG function that displays the receive status of registered channels in a bar graph allows registration of up to 5 channels by pressing and holding the [PMG PW] key for the current display frequency of either the VFO or the memory channel. The PMG screen can be switched to auto mode or manual mode by pressing the **DIAL** knob.

In auto mode, the PMG channel is continuously scanned, the channel with the signal is automatically stopped and the signal is heard. When the signal is concluded, the scan is automatically restarted. To operate on the received channel, press the PTT or DIAL knob to switch to manual mode, and the channel is fixed for communication.

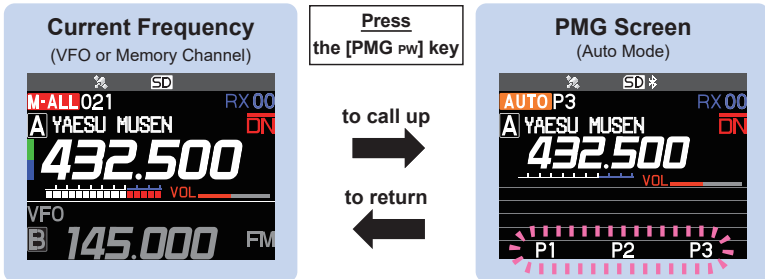

In auto mode, the channel with the signal is scanned and automatically stopped to play the signal. (The all channel number flashes during scanning)

- **Register the frequency to PMG**

Display the frequency of the VFO or memory channel, then press and hold the [PMG PW] key. The frequency is registered in PMG and the PMG screen is displayed.

- **Display the PMG screen**

Press the [PMG PW] key to display the PMG screen.

Press the **DIAL** knob to switch between Auto Mode and Manual Mode.

Auto Mode:

Scans and automatically stops at the channel with a signal and outputs the received audio. During output, the bar graphs of the other channels hold the last reception status and pause. When there is no signal, scanning is resumed and the receive status is displayed in real time. (The channel number flashes during scanning and there is no audio from the speaker.)

Manual Mode:

It is fixed to the channel selected by the **DIAL** knob, and when there is a signal, the received audio is output.

When there is no signal on the selected channel, it scans and displays the receive status of other channels in real time. (Even if there is a signal on another channel, the received audio is not output.)

Press and hold: Register or unregister

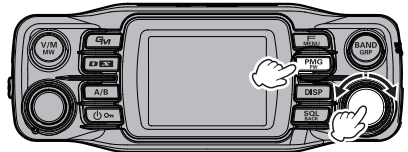

Press: Recall or exit PMG

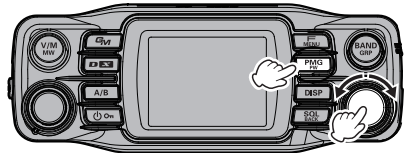

Rotate **DIAL** knob to select
Press **DIAL** knob to switch Auto Mode / Manual Mode

Press and hold: Unregister

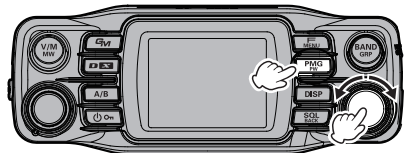

- **Cancel the frequency registered in PMG**

Select a channel on the PMG screen and press and hold the [PMG PW] key.

③ Band Scope page 57

The receive status (signal strength) of the channels before and after the current frequency can be displayed as a bar graph, whether in VFO mode or in memory mode.

Press the **[DISP]** key to display the band scope screen. When you set the channel with the signal you want to receive to the center with the **DIAL** knob, the scope display pauses and the received audio is played. When there is no signal, the scope display is automatically resumed.

Press: Displays the band scope

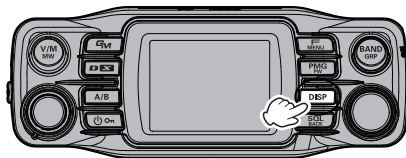

④ Memory auto grouping (MAG) function page 40

Memory channels can be automatically grouped and recalled for each band.

Press the **[BAND GRP]** key in memory mode. In the memory mode, each time the **[BAND GRP]** key is pressed, only memory channels of the specified frequency band are automatically recalled as a group, as shown below:

Press: Select the band to display in memory mode

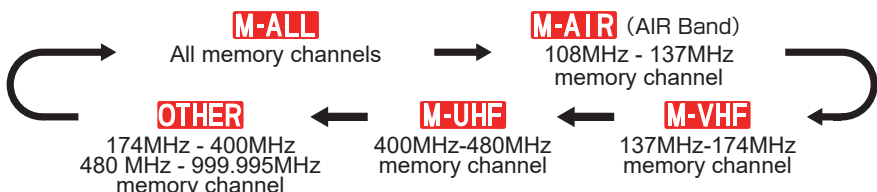
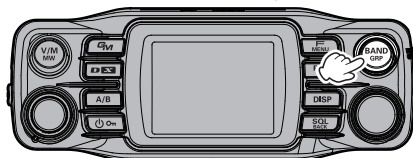

⑤ VFO Band skip function page 30

Bands that are not normally used can be skipped when the **[BAND GRP]** key is pressed.

In VFO mode, press and hold the **[BAND GRP]** key, select the band you want to set with the **DIAL** knob, and press the **DIAL** knob.

Then turn the **DIAL** knob to set "ON" (selectable) / "OFF" (not selectable).

You can still recall from All Memory Channels a frequency that is saved in the band set to be skipped.

Press and hold: Display the band select screen

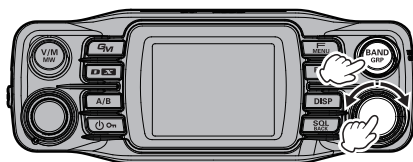

Turn **DIAL** to select a band
Press **DIAL** to select ON / OFF

⑥ Memory channel → VFO copy page 39

Transfers the recalled memory channel to the VFO with one-touch operation.





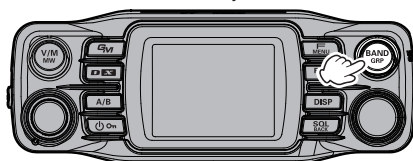







Press and hold the **[BAND GRP]** key while recalling a memory channel to transfer the memory channel information to the VFO and switch to VFO mode.

Press and hold: Copy to VFO in memory mode



Setup Menu List

Frequently used items from the below 124 Setup Menu types, can be registered to the Function List. (See page 31) The gray Setting items are registered in the Function List by factory default. See page 66 for detail information on the Setup Menu.

 DISPLAY	42 SQL TYPE	84 DIGI PATH 1
1 FREQUENCY INPUT (Fixed)	43 TONE SQL FREQ / DCS CODE	85 DIGI PATH 2
2 LCD BRIGHTNESS	44 SQL EXPANSION	86 DIGI PATH 3
3 FREQUENCY COLOR	45 PAGER CODE	87 DIGI PATH 4
4 BAND SCOPE	46 PR FREQUENCY	88 DIGI PATH FULL 1
5 LOCATION INFO	47 BELL RINGER	89 DIGI PATH FULL 2
6 COMPASS	48 WX ALERT	90 CALLSIGN (APRS)
7 DISPLAY MODE	 SCAN	91 MESSAGE GROUP
 TX	49 SCAN	92 MESSAGE REPLY
8 TX POWER	50 DUAL RCV MODE	93 MY POSITION SET
9 AMS TX MODE	51 DUAL RX INTRVAL	94 MY POSITION
10 MIC GAIN	52 PRIORITY REVERT	95 MY SYMBOL
11 VOX	53 SCAN RESUME	96 POSITION COMMENT
12 AUTO DIALER	 DIGITAL	97 SmartBeaconing
13 TOT	54 DIGITAL POPUP	98 SORT FILTER
14 DIGITAL VW	55 LOCATION SERVICE	99 VOICE ALERT
 RX	56 STANDBY BEEP	100 STATION LIST
15 FM BANDWIDTH	 GM	101 MESSAGE LIST
16 RX MODE	57 DP-ID LIST	102 BEACON TX SELECT
 MEMORY	58 RANGE RINGER	103 BEACON TX
17 HOME (Fixed)	59 RADIO ID	 SD CARD
18 MEMORY LIST	60 LOG LIST	104 BACKUP
19 MEMORY LIST MODE	 WIRES-X	105 MEMORY INFO
20 PMG CLEAR	61 RPT/WIRES FREQ	106 FORMAT
 CONFIG	62 SEARCH SETUP	 OPTION
21 BEEP	63 EDIT CATEGORYTAG	107 Bluetooth (Requires BU-4)
22 BAND SKIP	64 DELETE ROOM/NODE	108 VOICE MEMORY (Requires FVS-2)
23 RPT ARS	65 WIRES DG-ID	109 FVS REC
24 RPT SHIFT	 DATA	110 TRACK SELECT
25 RPT SHIFT FREQ	66 COM PORT	111 PLAY
26 RPT REVERSE	67 DATA BAND	112 STOP
27 MIC PROGRAM KEY	68 DATA SPEED	113 CLEAR
28 DATE&TIME ADJUST	69 DATA SQL	114 VOICE GUIDE
29 DATE&TIME FORMAT	 APRS	115 USB CAMERA (Requires MH-85A11U)
30 TIME ZONE	70 APRS DESTINATION	 CLONE
31 STEP	71 APRS FILTER	116 This → Other
32 CLOCK TYPE	72 APRS MSG TXT	117 Other → This
33 UNIT	73 APRS	 RESET
34 APO	74 APRS MUTE	118 CALLSIGN
35 GPS DATUM	75 APRS POPUP	119 MEMORY CH RESET
36 GPS DEVICE	76 APRS RINGER	120 APRS RESET
37 GPS LOG	77 APRS RINGER(CS)	121 CONFIG SET
 AUDIO	78 APRS TX DELAY	122 CONFIG RECALL
38 RECORDING	79 APRS UNITS	123 SOFTWARE VERSION
39 REC/STOP	80 BEACON INFO	124 FACTORY RESET
 SIGNALING	81 BEACON STATUS TXT	
40 DTMF	82 BEACON TX SET	
41 DTMF MEMORY	83 DIGI PATH	

Name and function of each component

Panel (front)

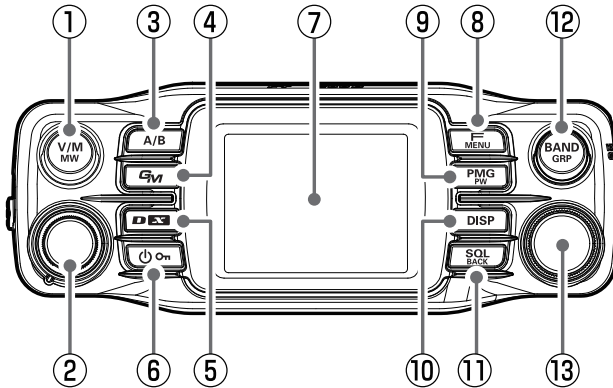

① V/M(MW) key

● Press:

Each key press switches between VFO mode and memory mode.

When a memory channel is recalled, the memory channel number is displayed, such as "M-ALL 001". The last operated memory channel is recalled.

● Press and hold:

The memory channel list screen is displayed.

Write to memory or recall and edit a stored memory channel.

② VOL knob

Adjust the audio volume.

③ A/B key

● Press:

Select the operation band.

Each press of this key switches between A band and B band.

● Press and hold:

Displays or hides Sub Band.

④ GM key

● Press:

The GM (Group Monitor) function is turned ON and automatically checks whether other stations are within the communications range.

- To use the GM function, the other station must also have the GM function turned ON.

- For details on using the function, refer to the GM Function Instruction Manual which may be downloaded from the Yaesu website.

● Press and hold:

The DG-ID number setting screen is displayed.

1. Rotate the DIAL knob to select [DG-ID TX] (transmit DG-ID number) or [DG-ID RX] (receive DG-ID number) and press the DIAL knob.

2. Rotate the DIAL knob to select the DG-ID number (00 to 99) and press the DIAL knob.

Press and hold the DIAL knob to reset both the send and receive DG-ID numbers to "00" at once.

⑤ D X key

● Press:

Each time this key is pressed the communication mode changes:

AMS (AMS / AMS) → DN → FM → AMS ...

Normally, the communication mode is set to automatically receive the mode of the partner station, by setting to "AMS" (AMS display example: AMS / AMS), which can receive the signal of the other station.

● Press and hold:

Start the WIRES-X.

- The WIRES-X enables worldwide digital communication in digital communication systems via the Internet.

(For details on this function, refer to the WIRES-X Function Instruction Manual which may be downloaded from the Yaesu website.)

- Press and hold the [D X] key again to return to the normal operation screen.

⑥ POWER (Om) Switch

Press and hold this button to switch the power ON or OFF.

When the power is ON, press this button briefly to engage, or release the key lock.

⑦ Full color screen display

Displays the frequencies and the various settings.

⑧ F MENU key

● Press:

Display the "Function List" screen. From the Setup Menu (see page 66), (Only up to 10 registered setup items are displayed for quick operation).

KEYPAD	HOME
SCAN	TXPWR HIGH
SQL OFF	ARS AUTO
RPT-R	TOPE 100.0
DTMF	APRS OFF
>	

Items other than the "KEYPAD" and "HOME" can be changed at any time. (see page 31)

Registration / Change:

Press and hold the [F MENU] key → select the setup item to be registered with the DIAL knob → press and hold the [F MENU] key

Cancel registration:

Rotate the DIAL knob to select the item to cancel the registration → Press and hold the [SQL BACK] key

● Press and hold:

The Setup Menu is displayed. (see page 60)

Rotate the DIAL knob to select an item and press the DIAL knob to use functions or make settings.

⑨ PMG PW key

● Press:

Displays PMG-SR (Primary Memory Group Activity Monitor for Single Receiver). (see page 45)

- Press the DIAL knob to switch between auto mode and manual mode.
- In auto mode, a certain frequency of the signal is automatically selected and you can hear the received sound.
- Press the PTT or DIAL knob to switch to manual mode, and use the DIAL knob to select the frequency for reception.
- Press again to cancel PMG mode.

● Press and hold:

Register the displayed frequency in PMG.

Press and hold in VFO mode or memory mode to register the current frequency in PMG.

Up to 5 channels can be registered for PMG regardless of the frequency band.

⑩ DISP key

● Press:

The scope screen displays a graph showing the signal strength of a number of channels, centered on the current VFO frequency or memory channel. (See page 57)

Press it again to return to the normal screen.

● Press and hold:

Displays the backtrack screen that shows the distance and direction of the partner station and permits navigation to a registered point.

⑪ SQL BACK key

● Press:

Press this key and then rotate the DIAL knob to adjust the squelch level.

Annoying noises can be muted when a signal cannot be detected. Normally, use the factory settings, but adjust the squelch if noise is harsh.

- On the Function List screen and Setup Menu screen, the screen returns to the previous screen currently being operated.

● Press and hold:

Press and hold on the Function List screen to cancel the registration of the selected item.

⑫ BAND GRP key

In VFO mode

● Press:

Each key press changes the operating frequency band.

Band	Selectable Frequency Range
AIR	108MHz - 137MHz
144MHz	137MHz - 174MHz
VHF	174MHz - 400MHz
430MHz	400MHz - 480MHz
UHF	480MHz - 999.99MHz

● Press and hold

Set the band that can be selected by pressing this key. In memory mode

In Memory mode

● Press:

With the memory auto grouping (MAG) function, only memory channels in the same frequency band are automatically recalled as a group.

Group	Selectable Memory Channels
M-ALL	All memory channels.
M-AIR	AIR band (108 - 137MHz) memory channels only.
M-VHF	144MHz band (137 - 174MHz) memory channels only.
M-UHF	430MHz band (400 - 480MHz) memory channels only.
OTHER	174MHz to 400MHz and 480MHz to 999.995MHz Memory channels only

● Press and hold:

Transfers the contents of the recalled memory channel to the VFO and enters VFO mode.

⑫ DIAL knob

Change the frequency or select the memory channel.

- In VFO mode, the frequency may be changed in 1MHz increments after pressing the knob. Tuning will be in 5MHz increments after pressing and holding the knob.
- In Memory Mode, press and then turn the knob to select in 10 channel steps..
- Press the [SQL BACK] key and then turn the knob to adjust the squelch level.

Panel (Left and right side)

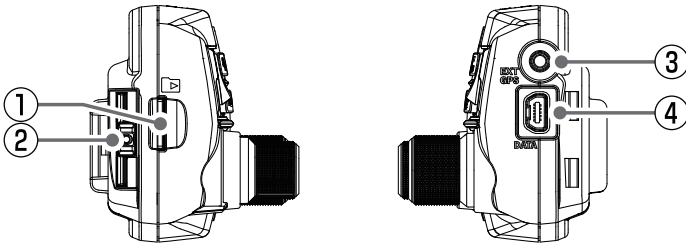

① micro-SD card slot

Insert a commercially available micro SD card to backup the various radio settings, memory channels, recordings of received audio, and recordings of snapshot images, etc.

② Release knob

Press to release the control panel from the transceiver.

③ EXT GPS jack

Plug in a cable to connect with external GPS devices. The communication baud rate is fixed at 9600bps.

④ DATA jack

- Connect MH-85A11U optional microphone with snapshot camera.

*It is not possible to output the receive audio to the MH-85A11U speaker.

- Connect to a PC with the included USB cable when updating the firmware (Sub).

Panel (rear)

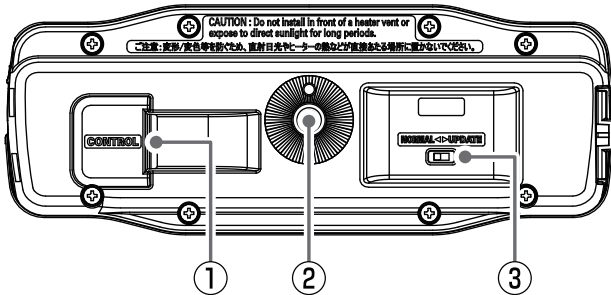

① CONTROL jack

Plug the control cable into this jack to connect with the main body.

② Screw hole for bracket

Attach the supplied panel bracket or the optional adjustable angle suction type control panel bracket MMB-98 with the supplied screws.

③ Firmware Update switch

This switch is used when updating the firmware (Sub).

Normally set to "NORMAL" position.

* Please refer to YAESU website for firmware updates.

Main body (Front)

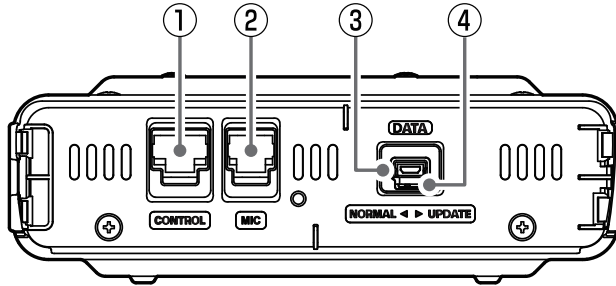

① **CONTROL jack**

Plug the control cable into this jack to connect with the control panel.

② **MIC jack**

Connect the cable of the included DTMF microphone SSM-85D or the optional microphone MH-42C6J.

③ **DATA jack**

When updating the firmware (Main / DSP), connect to the PC with the included USB cable. The optional microphone MH-85A11U cannot be connected to this jack.

④ **Firmware Update switch**

This switch is used when updating the Main firmware.

Usually set to the "NORMAL" position.

* Please refer to YAESU website for firmware updates.

Main body (rear)

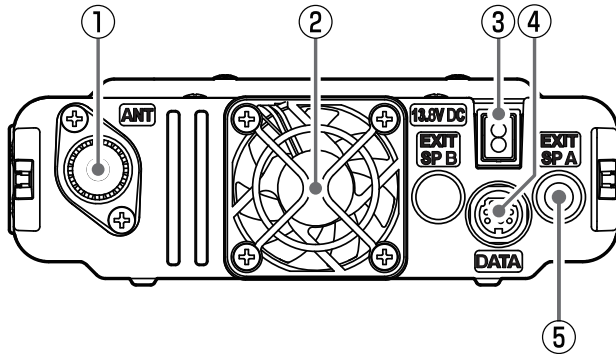

① **ANT terminal**

Connect the co-axial cable for the antenna.

② **Cooling fan**

③ **13.8V DC**

Connect the provided DC power supply cable (with fuse attached).

④ **DATA Jack**

Connect a cable for remote operation, or the cable to connect with the PC interface unit and the external terminal unit.

⑤ **EXT SP A jack**

Monaural jack ($\varnothing 3.5$ mm) for connecting external speaker .

Microphone (SSM-85D)

① MIC

Speak into the microphone during transmission.

② TX LED

Lights red while pressing PTT switch.

③ PTT

- Press and hold the **PTT** switch to transmit, and release it to receive.
- Press this key during the set mode to exit the set mode.

④ DWN

- Press this button to move the frequency or memory channel lower by one step, press and hold it to start scanning.
- On the memory channel list screen, press to select memory channels in 10 channel steps.
- On the Setup Menu screen, press to jump to the next category of the Setup Menu.

⑤ UP

- Press this button to move the frequency or memory channel up by one step, press and hold it to start scanning.
- On the memory channel list screen, press to select memory channels in 10 channel steps.
- On the Setup Menu screen, press to jump to the next category of the Setup Menu.

⑥ MUTE

Press this button to mute the receive audio. Press it again to unmute the audio.

⑦ DTMF keypad

Press these keys during transmit to enter and send a DTMF sequence.

The following operations can be performed during receive:

0 - 9 : Enter the frequency or memory channel number.

A : • In the VFO mode, switches the operation to A band. Press and hold this button to increase or decrease the frequency at 1MHz.

• In memory mode, fast forward the memory channels by 10 channels.

B : • In the VFO mode, switches the operation to B band. Press and hold to increase or decrease the frequency at 1MHz.

• In memory mode, fast forward the memory channels by 10 channels.

C : Adjust the squelch level.

D : The band scope function operates. Press and hold to display the backtrack screen.

* : VFO mode and memory mode are toggled.

: This key has the same function as the **[BAND GRP]** key on the controller.

VFO mode:

Each press changes the operating frequency band.

AIR → 144MHz → VHF → 430MHz → UHF

Memory mode:

Each time the key is pressed only memory channels of the same frequency band (except M-ALL) are automatically recalled as a group, as shown below:

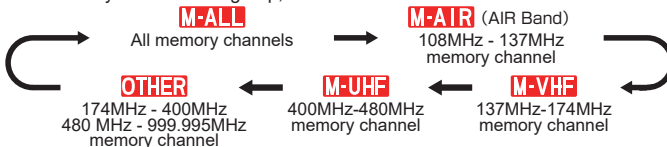

* Bands that have not been stored are not displayed.

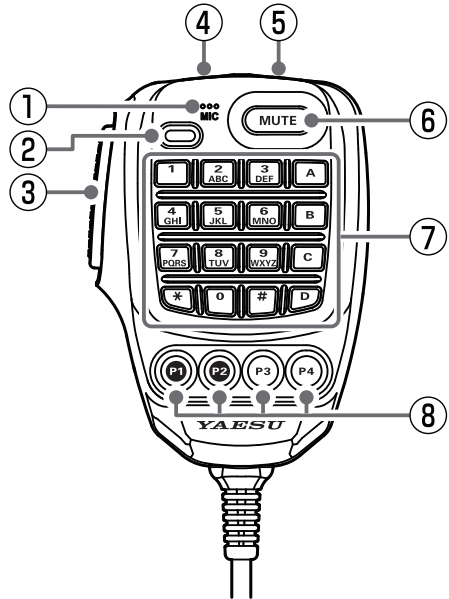

⑧ Programable keys (P1/P2/P3/P4)

The default function settings of the [P1] / [P2] / [P3] / [P4] keys are shown in the table below.

Key	Function	Press	Press and hold
P1*	GM*	GM Function	DG-ID setting screen
P2	HOME	Recalls HOME channel	
P3	D_X	Selects communication mode	Activates the WIRES-X feature
P4	WX (T-CALL)	WX (T-CALL: European version)	

* The function of the [P1] key is fixed.

The functions of the [P2] / [P3] / [P4] keys can be assigned by the following operations:

1. Press and hold the [F MENU] key.
2. Rotate the DIAL knob to select Set-up menu [CONFIG], then press the DIAL knob.
3. Rotate the DIAL knob to select [27 MIC PROGRAM KEY], then press the DIAL knob.
4. Rotate the DIAL knob to select a key to assign a function [P2] / [P3] / [P4] then press the DIAL knob.
5. Rotate the DIAL knob to select a function (see the table below) then press the DIAL knob.

Function	Description
OFF	(Disable the P key)
REC/STOP	Voice recording function "REC" / "STOP"
SCAN	Starts or stops the scanning function
HOME	Recalls the HOME channel
RPT SHIFT	Sets the repeater shift direction
REVERSE	Reverses the transmit and receive frequencies in repeater mode or split memory.
TX POWER	Selects the transmit power output level
SQL OFF	Opens the squelch (SQL off)
T-CALL	Transmits the T-CALL(1750 Hz)
VOICE	Announces the current frequency (requires optional FVS-2)
D_X	Press to select communication mode Press and hold to activate the WIRES-X feature
WX	Switches operation to the Weather Channel Bank
STN LIST	Displays the APRS function station list
MSG LIST	Displays the message list of the APRS function
REPLY	Enters the APRS function reply message write mode
MSG EDIT	Enters the APRS function message write mode
DW	Operation setting of dual receive function

Display

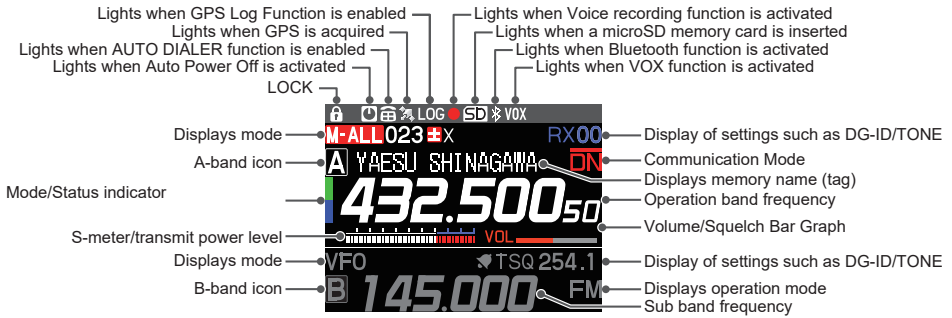

● Status Bar



Appears when the lock function is enabled.



Appears when the APO (Automatic Power-Off) function is enabled.



Appears when the DTMF Autodialer function is activated.



Appears when the GPS Satellites are acquired.



Appears when the GPS Log function is enabled.



Appears when the Voice recording function is activated. (About 3 seconds after the squelch closes, the recording pauses and a "II" appears.)



Appears when a microSD card is inserted.



Appears when the Bluetooth function is activated.
 Appears: Bluetooth device is connected.
 Blinks: Bluetooth device not connected.



Appears when the VOX function is enabled.

● A-band / B-band display area

Memory channels of the same frequency band are automatically grouped and recalled as follows by the memory auto grouping (MAG) function.

M-ALL	: Recalls all memory channels regardless of frequency band
M-AIR	: Recalls only memory channels in the AIR band (108 - 137 MHz).
M-VHF	: Recalls only memory channels in the 144 MHz band (137 - 174 MHz).
M-UHF	: Recalls only memory channels in the 430 MHz band (400 - 480 MHz).
OTHER	: Recalls only VHF and UHF memory channels (174 - 400 MHz and 480 - 999.995 MHz).
AUTO	: PMG (Primary Memory Group Activity Monitor) Function
PMG	AUTO : AUTO Mode PMG : Manual Mode

VFO VFO mode

HOME HOME Channel



Repeater minus (-) shift



Repeater plus (+) shift



Split Memory



Skip Memory Channel
(Permits designating undesired channels to be skipped during scanning.)



Bell function is activated.

Displays the DG-ID number for transmission and reception in C4FM digital mode

TX00

TX DG-ID is displayed (Only during transmission)

RX00

RX DG-ID is displayed

Squelch type for analog FM mode is displayed (For additional details, refer to the Advanced Manual.)

TN : Tone Encoder (tone frequency is displayed)

TSQ : Tone Squelch (tone frequency is displayed)

RTN : Reverse Tone (tone frequency is displayed)

DCS : DCS (Digital Code Squelch) (DCS code is displayed)

PR : No-communication Squelch

PAG : Pager (EPCS)









The following can be set when the squelch expansion (see page 69) is "ON":

DC : Send the DCS code only during transmission. (DCS code is displayed)





T-D : Send the CTCSS tone signal during transmit, and wait for the DCS code in receive mode. (tone frequency is displayed)

D-T : Send the DCS code during transmit, and wait for the CTCSS tone signal in receive mode. (tone frequency is displayed)

Displays the operating mode (Digital modes are indicated by a red icon):

-  : FM (Analog) mode
-  : V/D mode (Simultaneous voice and data communication mode)
-  : Voice FR mode (Voice full-rate mode)
-  : Data FR mode (High speed data communication mode)
-  : AMS (Automatic Mode Select) FM (Analog) mode
-  : AMS (Automatic Mode Select) DN mode
-  : AMS (Automatic Mode Select) VW mode
-  : AMS (Automatic Mode Select) DW mode

* When AMS (Automatic Mode Select) function is activated, the indicator is shown with a bar appearing above the mode. The transceiver automatically switches to the DW mode during image transmission.

-  : S meter (Displays received signal strength in 10 levels)
-  : PO meter (Displays transmit output in 3 levels when transmitting)
-  : Volume level
-  : SQL level

Descriptions of Main Screens

● Normal screen (VFO screen)

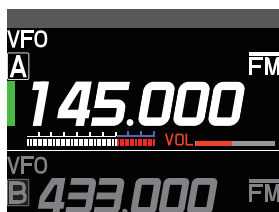

A-band and B-band are shown at the top and bottom of the display.

- The band displayed on the top of the screen is operating band.
- Press and hold the [A/B] key to turn the Sub Band display off.

NOTE: The A-band and B-band cannot be received at the same time.

● Band Scope screen

Press the [DISP] key to display the Band Scope screen.

The strengths of received signals above and below the current frequency or memory channel are shown in a bar graph while sweeping at high speed. The audio of the center frequency is heard without interruption.

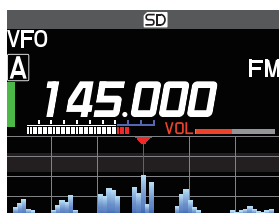

- Rotate the **DIAL** knob to change the center frequency or memory channel.
- In VFO mode 61 or 31 channels can be searched. In memory mode 21 or 11 channels can be searched by the Band Scope (See page 57)

● Function List screen

Press the [F MENU] key to display the "Function List" screen that displays only the registered items from the Setup Menu (see page 66). To return to the normal operation screen from the Function List, press a key other than the power switch or **PTT**.

KEYPAD	HOME
SCAN	TXPMR HIGH
SQL OFF	ARS AUTO
RPT-R	TONE 100.0
DTMF	APRS OFF
>	

By default, the following 10 steup items are registered in the Function List. Setup Menu items can be registered, canged, or canceled at any time.

1 FREQUENCY INPUT (FIXED)*	23 HOME (FIXED)*
49 SCAN	8 TX POWER
42 SQL TYPE	23 RPTARS
26 RPT REVERSE	43 TONE SQL FRQ / DCS CODE
40 DTMF	73 APRS

NOTE: The KEYPAD and HOME cannot be changed or unregistered.

● Setup Menu screen

Press and hold the [F MENU] key to display the Setup Menu screen. The Setup Menu allows selecting various functions from the displayed list and then setting the parameters of each function according individual preferences.

DISPLAY
1 FREQUENCY INPUT >
2 LCD BRIGHTNESS
3 FREQUENCY COLOR
4 BAND SCOPE
>

To return to the normal operation screen from the Setup Menu, press a key other than the power switch or **PTT**.

● BACKTRACK screen

Press and hold the [DISP] key to display the Backtrack screen.

• Real-time navigation function

Displays the position and direction of the contact station in real time during communication in C4FM digital DN mode (The transmission of the contact station must contain GPS location information). It is also possible to configure the display to show the traveling direction of your own station and the distance to the destination.

• BACKTRACK function

Register up to three locations ("★", "L1", "L2"), such as the departure point or the current location of another station, then display in real time, and navigate the distance and direction to the registered location from the current location.

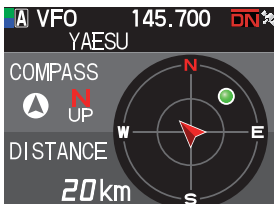

- Displays the position of other stations ("👤" icon is displayed).

[F(SETUP)] → [MEM] → [★], [L1], [L2]

Stores the current position of the other station.

- The "👤" icon indicates travel direction of this station.

[F(SETUP)] → [MEM] → [★], [L1], [L2]

Stores the current position of this station.

- [F(SETUP)] → [★], [L1], [L2]

Start navigation to the registered point.

● GPS Information screen

Press and hold [F MENU] → [7 DISPLAY MODE] → [GPS INFORMATION]

Displays the acquired GPS satellites and related information.

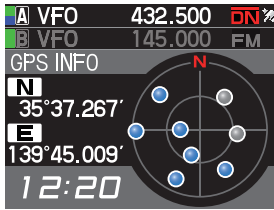

The following information is displayed:

- Direction and elevation of satellites
- Current latitude and longitude
- Local Time

● Altitude screen

Press and hold [F MENU] → [7 DISPLAY MODE] → [ALTITUDE]

The altitude versus the moving distance is displayed in a graph using the GPS signal.

● TIMER/CLOCK screen

Press and hold [F MENU] → [7 DISPLAY MODE] → [TIMER/CLOCK]

CLOCK, LAP timer and Countdown timer functions are available.

About this manual

The following notation is also used in this manual.



This icon indicates cautions and information that should be read.



This icon indicates notes, tips and information that should be read.

PLEASE NOTE: Due to product improvements, some of the illustrations in the instruction manual may differ from the actual product.

Safety Precautions (Be Sure to Read)

Be sure to read these important precautions, and use this product safely.

Yaesu is not liable for any failures or problems caused by the use or misuse of this product by the purchaser or any third party. Also, Yaesu is not liable for damages caused through the use of this product by the purchaser or any third party, except in cases where ordered to pay damages under the laws.

Types and meanings of the marks



DANGER

This mark indicates an imminently hazardous situation, which, if not avoided, could result in death or serious injury.



WARNING

This mark indicates a potentially hazardous situation, which, if not avoided, could result in death or serious injury.



CAUTION

This mark indicates a potentially hazardous situation, which, if not avoided, may result in minor or moderate injury or only property damage.

Types and meanings of symbols



These symbols signify prohibited actions, which must not be done to use this product safely. For example:  indicates that the product should not be disassembled.



These symbols signify required actions, which must be done to use this product safely. For example:  indicates that the power plug should be disconnected.



DANGER



Do not use the device in "regions or aircraft and vehicles where its use is prohibited" such as in hospitals and airplanes.

This may exert an impact on electronic and medical devices.



Do not use this product while driving or riding a motorbike. This may result in accidents.

Make sure to stop the car in a safe location first before use if the device is going to be used by the driver.



Do not operate the device when flammable gas is generated.

Doing so may result in fire and explosion.



Never touch the antenna during transmission.

This may result in injury, electric shock and equipment failure.



Do not transmit in crowded places in consideration of people who are fitted with medical devices such as heart pacemakers.

Electromagnetic waves from the device may affect the medical device, resulting in accidents caused by malfunctions.



When an alarm goes off with the external antenna connected, cut Off the power supply to this radio immediately and disconnect the external antenna from this radio.

If not, this may result in fire, electric shock and equipment failure.



Do not touch any liquid leaking from the liquid display with your bare hands.

There is a risk of chemical burns occurring when the liquid comes into contact with the skin or gets into the eyes. In this case, seek medical treatment immediately.



WARNING



Do not use voltages other than the specified power supply voltage.

Doing so may result in fire and electric shock.



Do not transmit continuously for long periods of time.

This may cause the temperature of the main body to rise and result in burns and failures due to overheating.



Do not dismantle or modify the device.

This may result in injury, electric shock and equipment failure.



Do not handle the power plug and connector etc. with wet hands. Also do not plug and unplug the power plug with wet hands.

This may result in injury, liquid leak, electric shock and equipment failure.



When smoke or strange odors are emitted from the radio, turn Off the power and disconnect the power cord from the socket.

This may result in fire, liquid leak, overheating, damage, ignition and equipment failure. Please contact our company amateur customer support or the retail store where you purchased the device.



Keep the power plug pins and the surrounding area clean at all times.

Contamination may result in fire, liquid leak, overheating, breakage, ignition etc.





Disconnect the power cord and connection cables before incorporating items sold separately or replacing the fuse.

This may result in fire, electric shock and equipment failure.

 **Never cut off the fuse holder of the DC power cord.**
This may cause short-circuiting and result in ignition and fire.

 **Do not use fuses other than those specified.**
Doing so may result in fire and equipment failure.

 **Do not allow metallic objects such as wires, or water to get inside the product.**
This may result in fire, electric shock and equipment failure.

 **Do not place the device in areas that may get wet easily (e.g. near a humidifier).**
This may result in fire, electric shock and equipment failure.

 **When connecting a DC power cord, pay due care not to mix up the positive and negative polarities.**
This may result in fire, electric shock and equipment failure.

 **Do not use DC power cords other than the one enclosed or specified.**
This may result in fire, electric shock and equipment failure.

 **Do not bend, twist, pull, heat and modify the power cord and connection cables in an unreasonable manner.**
This may cut or damage the cables and result in fire, electric shock and equipment failure.

 **Do not pull the cable when plugging and unplugging the power cord and connection cables.**
Please hold the plug or connector when unplugging. If not, this may result in fire, electric shock and equipment failure.

 **Refrain from using headphones and earphones at a loud volume.**
Continuous exposure to loud volumes may result in hearing impairment.

 **Do not use the device when the power cord and connection cables are damaged, and when the DC power connector cannot be plugged in tightly.**
Please contact our company amateur customer support or the retail store where you purchased the device as this may result in fire, electric shock and equipment failure.

 **Follow the instructions given when installing items sold separately and replacing the fuse.**
This may result in fire, electric shock and equipment failure.

 **Do not use the device when the alarm goes off.**
For safety reasons, please pull the power plug of the DC power equipment connected to the product out of the AC socket.

 Never touch the antenna as well. This may result in fire, electric shock and equipment failure due to thunder.

CAUTION

 **Do not place this device near a heating instrument or in a location exposed to direct sunlight.**
This may result in deformation and discoloration.

 **Do not place this device in a location where there is a lot of dust and humidity.**
Doing so may result in fire and equipment failure.

 **Stay as far away from the antenna as possible during transmission.**
Long-term exposure to electromagnetic radiation may have a negative effect on the human body.

 **Do not wipe the case using thinner and benzene etc.**
Please use a soft and dry piece of cloth to wipe away the stains on the case.

 **Keep out of the reach of small children.**
If not, this may result in injuries to children.

 **Do not put heavy objects on top of the power cord and connection cables.**
This may damage the power cord and connection cables, resulting in fire and electric shock.

 **Do not transmit near the television and radio.**
This may result in electromagnetic interference.

 **Do not use optional products other than those specified by our company.**
If not, this may result in equipment failure.

 **When using the device in a hybrid car or fuel-saving car, make sure to check with the car manufacturer before using.**
The device may not be able to receive transmissions normally due to the influence of noises from the electrical devices (inverters etc.) fitted in the car.

 **For safety reasons, switch off the power and pull out the DC power cord connected to the DC power connector when the device is not going to be used for a long period of time.**
If not, this may result in fire and overheating.

 **Do not throw or subject the device to strong impact forces.**
This may result in equipment failure.

 **Do not put this device near magnetic cards and video tapes.**
The data in the cash card and video tape etc. may be erased.

 **Do not turn on the volume too high when using a headphone or earphone.**
This may result in hearing impairment.

 **Do not place the device on an unsteady or sloping surface, or in a location where there is a lot of vibration.**
The device may fall over or drop, resulting in fire, injury and equipment failure.

 **Do not stand on top of the product, and do not place heavy objects on top or insert objects inside it.**
If not, this may result in equipment failure.

 **Do not use a microphone other than those specified when connecting a microphone to the device.**
If not, this may result in equipment failure.

 **Do not touch the heat radiating parts.**
When used for a long period of time, the temperature of the heat radiating parts will get higher, resulting in burns when touched.

 **Do not open the case of the product except when replacing the fuse and when installing items sold separately.**
This may result in injury, electric shock and equipment failure.

About the antenna

The antenna is an extremely important part for both transmitting and receiving. The antenna type and its inherent characteristics determine whether the performance of the transceiver can be fully realized. As such, please note the following:

- Use an antenna that is suitable for the installation conditions and application objective.
- Use an antenna that is suitable for the operating frequency band.
- Use an antenna and a coaxial cable with a characteristic feed point impedance of 50Ω .
- Adjust the VSWR (Voltage Standing Wave Ratio) until it is 1.5 or less for an antenna with an adjusted impedance of 50Ω .
- Keep the coaxial cable routing length as short as possible.

Connection of Antenna and Power Cables

Please follow the outline in the illustration regarding the proper connection of antenna coaxial cables and Power Supply.

Cautions

- Do not use a DC power supply cable other than the one that is provided.
- Do not use the DC power supply cable with the fuse holder cut off.
- Use an external power source capable of supplying DC 13.8 V, a current capacity of 15 A or more.

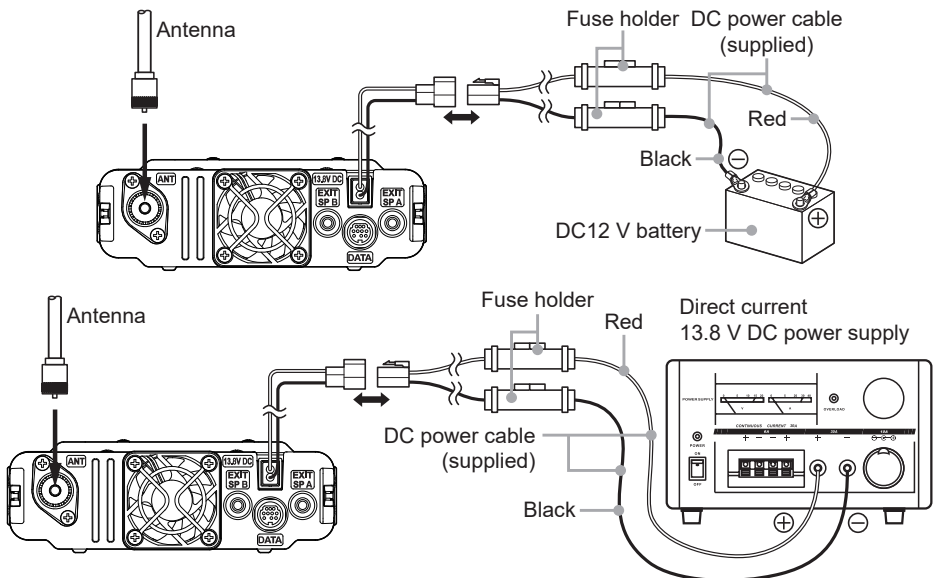

Installing the transceiver

Install the main body and the front panel using the supplied brackets.



- The bracket can be formed by hand to match the location where the front panel is installed.
- Be careful not to cause an injury when bending the bracket.
- The front panel has a built-in GPS antenna. It is recommended to install on the dashboard or in front of the center console to receive the radio wave from GPS efficiently.

1. Select the installation location.

Caution : Select a location where the transceiver can be securely attached.

2. Drill four 6mm diameter holes in the location where the bracket is to be mounted, matching the positions of the bolting holes of the bracket.
3. Insert the grooves on both sides of the main body into the bracket until they click and lock. Tighten the screw against the lever to lock the transceiver in the bracket.
4. To remove the main body from the bracket, loosen the locking screw, and then pull the transceiver out while pressing the lever indicated by the arrow below.

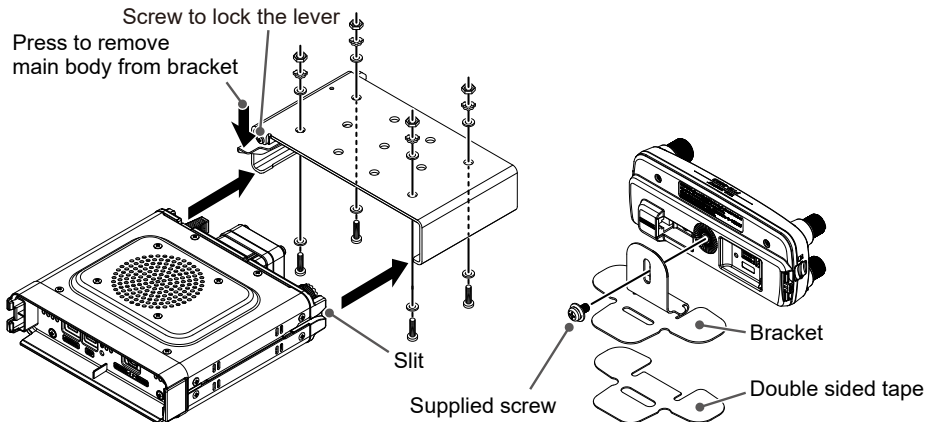

Connecting the front panel to the main body

Connect the transceiver to the “CONTROL” terminal of the control panel with the included control cable. Connect the cable of the supplied microphone SSM-85D to the “MIC” terminal of the transceiver.

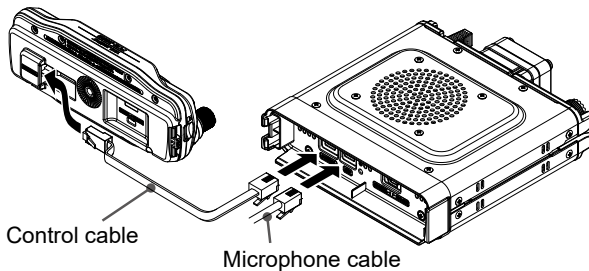

Using a Micro SD Memory Card

Using a microSD memory card with the transceiver allows the following functions.

- Backing up the transceiver data and information
- Saving memory information
- Voice recording and playback
- Saving image data captured with the optional camera-equipped microphone (MH-85A11U)
- Saving messages downloaded with the GM function or WIRES-X function
- Saving GPS log data

Usable microSD Memory Cards

This transceiver only supports the following capacity of microSD and microSDHD memory cards.

• 2GB • 4GB • 8GB • 16GB • 32GB



- microSD memory cards formatted on other devices may not properly save information when used with this transceiver. Format microSD memory cards again with this transceiver when using memory cards formatted with another device.
- Do not remove the microSD memory card or turn the transceiver Off, while saving data to a microSD memory card is in progress.

Mounting and Dismounting microSD Memory Card

1. Turn the transceiver **OFF**.
2. Insert a microSD memory card into the slot on the left side of the controller.
With the terminal surface of the microSD card facing the back of the controller, push it in gently until it clicks.
3. Turn the transceiver **ON**.
When the memory card is properly detected, “**SD**” lights on the display.

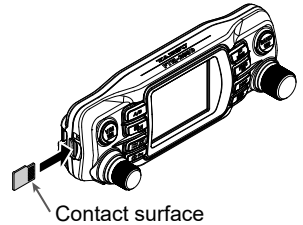

● Removing the microSD memory card

To remove the microSD memory card (inserted in step 2 above), push the memory card in until a clicking sound is heard, then remove the memory card.

Formatting a Micro SD Memory Card

Format a new microSD memory card following the steps below before use:



- A microSD memory card that was used in another device may not function properly, for example, it may not be recognized by the FTM-200DR/DE, or reading and writing may take an unusually long time. Use of the SD Memory Card Formatter provided by the SD Association may improve this. The SD Memory Card Formatter can be downloaded from this URL (<https://www.sdcard.org/downloads/formatter/index.html>).
- Formatting a microSD memory card erases all data saved on it. Before formatting the card, be sure to check for data and save it before formatting.

1. Press and hold the [**F MENU**] key.
2. Rotate the **DIAL** knob to select [**106 FORMAT**], then press the **DIAL** knob.
“**FORMAT?**” appears on the LCD.
3. Rotate the **DIAL** knob to select [**OK**], then press the **DIAL** knob.
Initialization starts and “**Waiting**” appears.
4. When formatting is completed, a beep sounds and “**COMPLETED**” appears on the LCD.

Functions to use as needed

Selecting the Communication Mode

● Using AMS (Automatic Mode Select) function

The FTM-200DR/DE transceiver is equipped with the AMS (Automatic Mode Select) function which automatically selects the communication mode corresponding to the received signal.

To utilize the AMS function, press the [D X] key repeatedly to display “FM”*, “DN”* or “VW”* on the display. When a signal is received, the communication mode is automatically switched and the communication mode display changes.

*The display differs depending on the received signal.

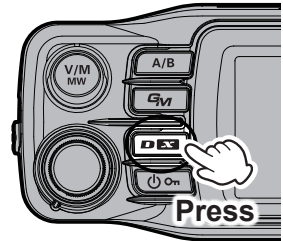

● Setting the transmit mode when using the AMS function

The AMS function will automatically set the receiver to the mode of the received signal, but the transmit mode may be fixed regardless of the received mode.

1. Press and hold the [F MENU] key.
2. Rotate the **DIAL** knob to select [9 AMS TX MODE], then press the **DIAL** knob.
3. Press the **DIAL** knob to select the desired transmit mode as follows:

When set to “TX FM FIXED” or “TX DN FIXED” and the AMS transmission mode is fixed, the “bar” at the top of the communication mode icon flashes.

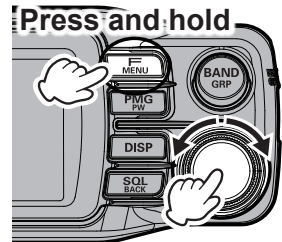

Transmit Mode	Transmit	Receive
AUTO (default)	Automatically transmits in the communication mode selected by the AMS function.	Automatically selects the receive mode corresponding to the received signal.
TX FM FIXED	Always transmits in the analog FM mode.	
TX DN FIXED (TX DIGITAL)	Always transmits in the DN mode.	

4. To return to the normal operation screen from the Function List, press a key other than the power switch or **PTT**.

Fixing the Communication Mode

- To fix the transmit operation mode, press the **[D X]** key to select the communication mode.

When the AMS function is Off, the “bar” at the top of the communication mode icon is not displayed.

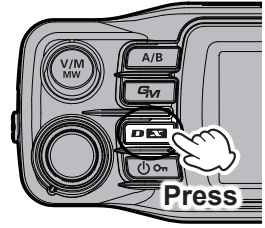

Communication Mode	Icon	Description of Modes
V/D mode (Voice & Data are transmitted simultaneously)		This is the standard digital mode. Calls are less prone to interruptions caused by detection and correction of the received digital voice signal.
Voice FR mode* ¹ (Voice Full Rate Mode)		High speed data communication using entire 12.5 kHz band. Enables high-quality voice communication.
FM mode		Analog communication using FM mode.
AM mode (receive only)* ²		The AM mode is for receive only.

*1 When the Setup Menu Mode [14 DIGITAL VW] is set to “ON” (factory default is “OFF”), the Voice FR mode (VW) may be selected.

*2 When the Setup Menu Mode [16 RX MODE] is set to “AM” (factory default is “AUTO”), the AM mode is selected in bands other than the AIR band (108 - 136.995 MHz).



The transceiver automatically switches to the Data FR mode (DW) mode during image transmission.

Changing the Transmit Power Level

The transmit power output can be set on the Function List screen.

- Press the **[F MENU]** key.
- Rotate the **DIAL** knob to select **[TXPWR]**, then press the **DIAL** knob.
Or press and hold the **[F MENU]** key → “8 TX POWER”
- Rotate the **DIAL** knob to select the TX power output.
“LOW” ↔ “MID” ↔ “HIGH”

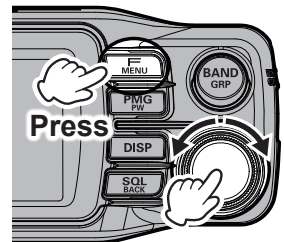

HIGH	MID	LOW
50 W	25 W	5 W

*: The factory setting is “HIGH”.

- To return to the normal operation screen from the Function List, press a key other than the power switch or **PTT**.



The transmit power output can be set individually for each frequency band and memory channel in each of A band and B band.

Setting the Skip Band

Set the band selected when the [BAND GRP] key is pressed. By storing frequently used frequencies in the memory channel before setting the band skip, can be recall the memory that stores the frequencies of the bands that cannot be selected.

1. Press and hold the [BAND GRP] key in VFO mode.
2. Rotate the DIAL knob to select the band to set and press the DIAL knob.
Or press and hold the [F MENU] key → [22 BAND SKIP]
3. Rotate the DIAL knob to set "ON" (selectable) or "OFF" (not selectable).
4. To return to the normal operation screen from the Function List, press a key other than the power switch or PTT.

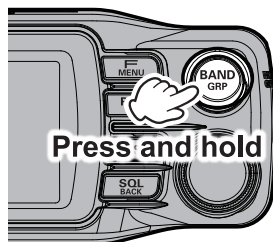

Changing the Frequency Step

The DIAL knob rotation frequency step may be changed. Normally, use the factory default setting of "AUTO".

1. Press and hold the [F MENU] key.
2. Rotate the DIAL knob to select [31 STEP], then press the DIAL knob.
3. Rotate the DIAL knob to set the frequency step.
4. To return to the normal operation screen from the Function List, press a key other than the power switch or PTT.

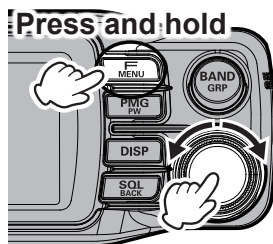

- The default setting, of the frequency step is set to "AUTO", which automatically provides a suitable frequency step according to the frequency band.
- The frequency steps that can be selected depend on the frequency band.

Change the frequency display color of the operation band

The display color of the frequency of the operation band can be selected from "white", "blue", and "red".

1. Press and hold the [F MENU] key.
2. Rotate the DIAL knob to select [3 FREQUENCY COLOR], then press the DIAL knob.
3. Rotate the DIAL knob to select the display color.
"WHITE" ↔ "BLUE" ↔ "RED"
4. To return to the normal operation screen, press a key other than the power switch or PTT.

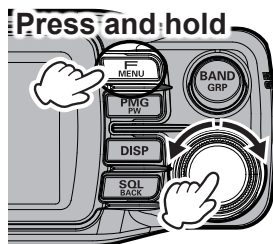

Custom Function List

Easily operate frequently used functions by calling them from the function list with one-touch operation of the [F MENU] key. You can view the list of registered priority functions and the setting status at a glance, and you can execute the function or change the setting just by selecting and pressing with the **DIAL** knob.

The following functions are registered in the function list by factory default, but you can register up to 8 frequently used functions from 124 setup menu types (see page 66) and customize the list to suit your usage.

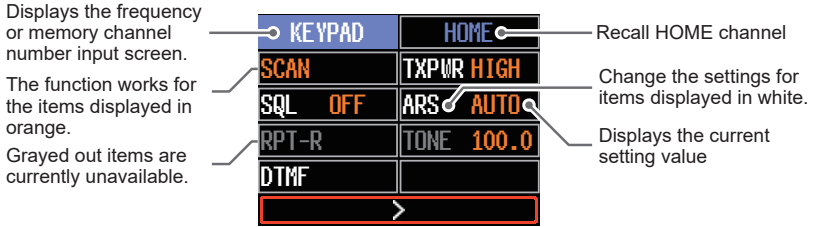

Function List display example (factory default setting)

1 FREQUENCY INPUT (FIXED)*	23 HOME (FIXED)*
49 SCAN	8 TX POWER
42 SQL TYPE	23 RPT ARS
26 RPT REVERSE	43 TONE SQL FRQ / DCS CODE
40 DTMF	73 APRS

NOTE: The “KEYPAD” and “HOME” displayed at the top of the screen cannot be changed.

Use the Function List

1. Press the [F MENU] key.
2. Rotate the **DIAL** knob to select the desired function, and then press the **DIAL** knob.

● Close the Function List

1. To return to the normal operation screen, press a key other than the power switch or **PTT**.

Press: to display the function menu

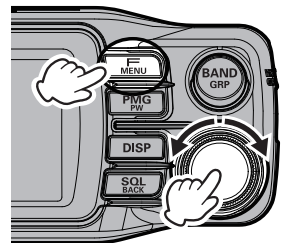

Registration to the Function List

1. Press and hold the [F MENU] key.
The Setup Menu screen is displayed.
2. Rotate the **DIAL** knob to select the item to be registered in the Function List.

□ DISPLAY
1 FREQUENCY INPUT >
2 LCD BRIGHTNESS
3 FREQUENCY COLOR
4 BAND SCOPE
MAX

3. Press and hold the [F MENU] key.
The Function List screen appears, and the selected function name flashes.

NOTE: The “KEYPAD” and “HOME” displayed at the top of the screen cannot be changed.

KEYPAD	HOME
BRIGHTNESS	TXPWR HIGH
SQL OFF	ARS AUTO
RPT-R	TONE 100.0
DTMF	APRS OFF
Write to FUNCTION MENU	

4. Rotate the **DIAL** knob to select the location to register.

KEYPAD	HOME
SCAN	TXPWR HIGH
SQL OFF	ARS AUTO
RPT-R	TONE 100.0
BRIGHTNESS	APRS OFF
Write to FUNCTION MENU	

5. Press the **DIAL** knob.
 - The function is registered in the selected location and the Function List is changed.
 - If a location that has already been registered is selected, that item will be overwritten.

KEYPAD	HOME
SCAN	TXPWR HIGH
SQL OFF	ARS AUTO
RPT-R	TONE 100.0
BRIGHTNESS	APRS OFF
>	

Cancel registration in the Function List

1. Press and hold the [F MENU] key.
The Function List screen is displayed.
2. Rotate the **DIAL** knob to select the registered item to cancel.

NOTE: The “KEYPAD” and “HOME” displayed at the top of the screen cannot be changed.

3. Press and hold the [SQL BACK] key.
The confirmation screen will be displayed.
4. Rotate the **DIAL** knob to select [OK] and press the **DIAL** knob.

The item will be deleted and the list item will be blank.

KEYPAD	HOME
SCAN	TXPWR HIGH
SQL OFF	ARS AUTO
RPT-R	TONE 100.0
BRIGHTNESS	APRS OFF
MAX	

KEYPAD	HOME
SCAN	TXPWR HIGH
SQL OFF	ARS AUTO
RPT-R	TONE 100.0
	APRS OFF

Using the convenient Digital C4FM features

About the Digital Group ID (DG-ID) feature

Digital Group ID (DG-ID) function permits using the two-digit ID numbers to communicate only with specific group members. The desired DG-ID number from 00 to 99 is set in advance by all the group members. This ID number may be set separately for transmit and receive, when the same ID number is set for both transmit and receive, only group members with the same ID number will be heard. This feature may be used to limit communication only to group members that have the same DG-ID number. The GM function may also be utilized to automatically monitor whether or not group member stations with the same DG-ID number are operating within communication range.

The DG-ID number 00 detects signals with all ID numbers. Normally setting the ID number to "00" for both transmit and receive will permit reception of the signals from all other stations using the digital C4FM mode, regardless of the transmit DG-ID number settings of the other stations.

Also note that when the receive DG-ID number of the transceiver is set to a DG-ID number other than "00", received signals that do not have the same DG-ID number may not be heard.

When accessing a C4FM digital repeater controlled by a DG-ID number, set the transmit DG-ID number of the FTM-200DR/DE to that of the repeater input. Even in that case, if the receive DG-ID number of the FTM-200DR/DE is set to "00", all the downlink signals from the repeater may be received.

Communicating with the DG-ID feature



- Digital C4FM mode transceivers compatible with the DG-ID function are required in order to utilize this function.
- If the firmware is not compatible with the DG-ID function, update to the latest firmware to use the DG-ID function. The latest firmware is available on the YAESU website.

Setting the transmit and receive DG-ID number to "00" to communicate with all other stations using C4FM digital mode

1. Press and hold the [GM] key.
The DG-ID number setting screen will be displayed.



While setting the DG-ID number, pressing and holding the **DIAL** knob will set the transmit and the receive DG-ID numbers to "00".

2. If the transmit DG-ID (DG-ID TX) number is not set to "00", press the **DIAL** knob, and then rotate the **DIAL** knob to set "00".
3. Press the **DIAL** knob again, and rotate the **DIAL** knob to select the receive DG-ID (DG-ID RX).
4. If the receive DG-ID number is not set "00", press the **DIAL** knob, then rotate the **DIAL** knob to set "00".

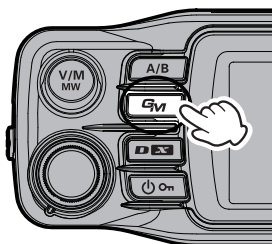

5. To return to the normal operation screen from the Function List, press a key other than the power switch or **PTT**.
6. To check whether or not other stations are operating within communications range, press the [**GM**] key to turn the GM (Group Monitor) function ON.
 - The other stations must also have the GM (Group Monitor) function ON.
 - Refer to the separate Operating Manual GM Edition for details on how to use the GM function (download the manual from our YAESU website).
7. Press the [**GM**] key to turn the GM (Group Monitor) function OFF and return to normal operations.



- If the receive DG-ID is set to a number other than “00”, only signals with that DG-ID will be received. Normally, set the receive DG-ID number to “00” except when communication is desired only with group members.
- The transmit and receive DG-ID default number is set to “00”.

Communicate only with the specific members by setting the DG-ID number to other than “00”

Example: Set the DG-ID number to “50”

1. Press and hold the [**GM**] key.
The DG-ID number setting screen will be displayed.



While setting the DG-ID number, pressing and holding the **DIAL** knob will set the transmit and the receive DG-ID numbers to “00”.

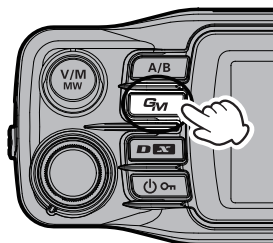

2. Press the **DIAL** knob, and then rotate the **DIAL** knob to set transmit DG-ID (DG-ID TX) number to “50”.
3. Press the **DIAL** knob again, then rotate the **DIAL** knob to select the receive DG-ID (DG-ID RX).

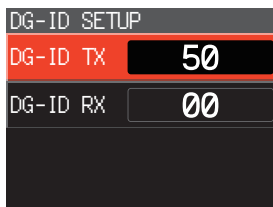

4. Press the **DIAL** knob, and then rotate the **DIAL** knob to set receive DG-ID (DG-ID RX) number to “50”.
5. To return to the normal operation screen from the Function List, press a key other than the power switch or **PTT**.
Tuning to the same frequency and setting the same DG-ID for all the group members will enable communication between the members and exclude other signals.

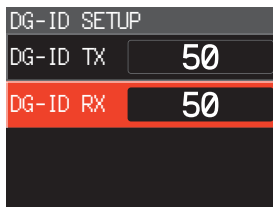

- Press the **[GM]** key to turn the GM (Group Monitor) function ON and check whether or not other stations that are operating on frequency, with the GM (Group Monitor) function ON, and have the same GD-ID number setting, are in the communication range.
- The other stations must also have the GM (Group Monitor) function ON.

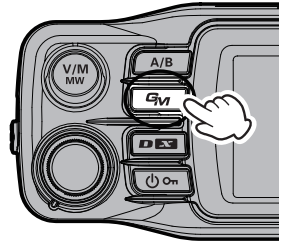

6. Press the **[GM]** key to turn the GM (Group Monitor) function OFF and return to the normal operation.

While operating in the GM function, the call signs and the signal strengths of a maximum 24 stations with the GM function turned ON, and that are within the communication range, may be checked.



For details on how to set each item, refer to "FTM-200DR/DE GM Function Instruction Manual" which is available on the Yaesu website.

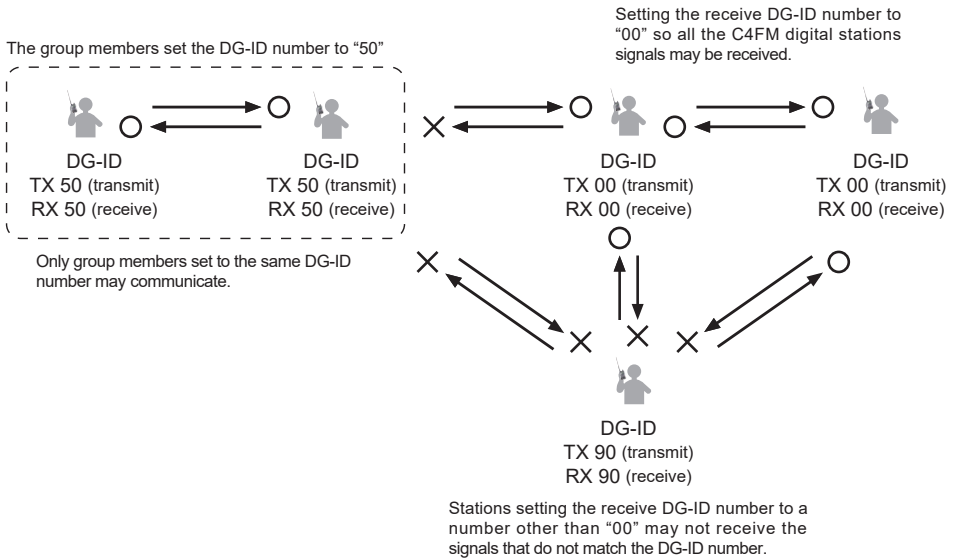

Repeater Operation

Communicating Via the Repeater

The transceiver includes an ARS (Automatic Repeater Shift) function which automatically sets the repeater operation when the receiver is tuned to the repeater frequency.

1. Set the receive frequency to the repeater frequency “-” or “+” appears on top of the display.
2. “-” or “+” may automatically appear above the frequency.
3. Speak into the microphone while pressing and holding the PTT switch.

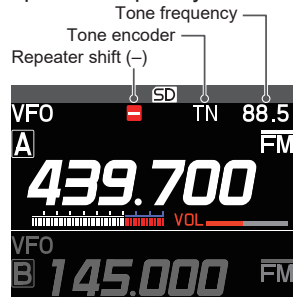

● Reverse function

The “reverse” operation temporarily reverses the transmit and receive frequencies. This permits checking to find if direct communication with the other station is possible.

1. Press the [F MENU] key.
2. Rotate the **DIAL** knob to select [RPT-R], then press the **DIAL** knob.
 - Or press and hold the [F MENU] key → “26 RPT REVERSE”
 - The transmit and receive frequencies are temporarily reversed (“reverse” state).
 - In the “reverse” state, the “-” or “+” blinks on the display.
3. To release the reverse state, repeat the above steps again.

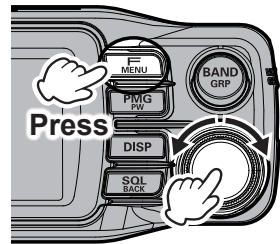

The repeater settings may be changed from the Setup Menu.

Press [F MENU] → [ARS]: The ARS function may be set to OFF

Press [F MENU] → [TONE]: CTCSS Tone frequency

Press and hold [F MENU] → [24 RPT SHIFT]: Allows setting the repeater shift direction.

Press and hold [F MENU] → [25 RPT SHIFT FREQ]: Allows changing the repeater shift offset.



● Tone Calling (1750 Hz)

If your transceiver is FTM-200DE (European version), press and hold in the [P4] key on the microphone (in factory default setting) to generate a 1750 Hz burst tone and access the European repeater. The transmitter will automatically be activated, and a 1750 Hz audio tone will be superimposed on the carrier. Once access to the repeater has been gained, release the [P4] key, and use the PTT key to activate the transmitter thereafter. If you need to access repeaters which require a 1750 Hz burst tone for access by the FTM-200DR (USA/Asian versions), set a program key on the microphone to serve as a “T-CALL” key. To change the configuration of the program key, press and hold [F MENU] → [27 MIC PROGRAM KEY].

Using the Memory

The FTM-200DR/DE incorporates a large number of memory channels that can register the operating frequency, communication mode, and other operational information.

- 999 Memory Channels
 - 5 Home Channels
 - 50 pairs PMS Memory Channels
- The memory auto grouping (MAG) function can automatically recall a list of memory channels from the same frequency band as a group.
- The PMG-SR (Single Receiver Primary Memory Group Activity Monitor) function displays the status of registered frequently used frequencies (received signal strength) in a bar graph, and automatically selects and receives the channel with the signal.

The operating frequency and other operational information can be registered to each regular memory channel, home channel, or PMS memory channel:

- Operating frequency
- Transmitter output
- TX/RX DG-ID
- Memory channel skip information
- Communication Mode
- Memory tag
- Tone information
- Frequency Step
- Repeater Shift
- DCS information

NOTE

Back up the stored contents to a microSD memory card. See the Advanced Manual for details on backing up to a microSD card.

Writing to memory

1. Set the VFO frequency to write to memory.
2. Press and hold the **[V/M MW]** key.

The memory channel list appears.

The lowest available channel number is selected. To select another channel, rotate the **DIAL** knob to select the memory channel number to be written.

The memory channel list can also be displayed by the following operations:

Press the **[F MENU]** key → Select **[KEYPAD]** →
Press the **DIAL** knob → Select **[MEMORY CH LIST]** →
Press the **DIAL** knob

The last used memory channel is selected.



- Press the **[UP]** or **[DWN]** key on the microphone to select in 10 channel steps.
- Press the number keys on the microphone to quickly select a memory channel as shown in the example below:
Press the **[1]** key: Memory channel **100**
Press the **[A]** key: PMS Memory channel **L01**
- When **[HOM]** at the top of the memory channel list is selected, the HOME channel of the current frequency band can be overwritten.



For already written memory channels, the writing frequency is displayed.

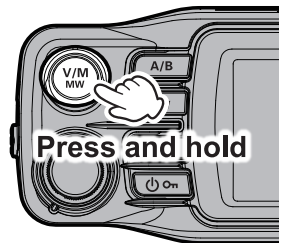

MEMORY CH LIST	
001	145.000
002	!!!.!!!! - - - -
003	!!!.!!!! - - - -
004	!!!.!!!! - - - -

3. Press and hold the **[V/M MW]** key.



Alternatively, press the **DIAL** knob to highlight **[WRITE]** and a pop-up will be displayed. Press the **DIAL** knob again.

If you attempt to register a frequency to a memory channel that already contains frequency data, “**OVER WRITE?**” will appear on the screen. Rotate the **DIAL** knob to select **[OK]**, then press the **DIAL** knob to overwrite the memory channel.



4. The memory is stored.

The written memory channel is recalled.

Recall memory (There are three ways)

(1) Press **[V/M]** key to recall

1. Press the **[V/M MW]** key.

The last used memory channel is recalled.

2. Rotate the **DIAL** knob to select the memory channel to recall.

- Press and then rotate the **DIAL** knob to select in 10-channel steps.
- Press the **[V/M MW]** key again to return to VFO mode.

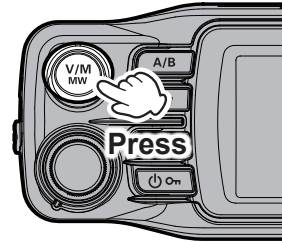

(2) Recall from the Function List

1. Press the **[F MENU]** key.

2. Press the **DIAL** knob.

Or press and hold the **[F MENU]** key → **[1 FRERQUENCY INPUT]**

3. Rotate the **DIAL** knob to select **[MEMORY CH LIST]** then press the **DIAL** knob.

The memory channel list appears.

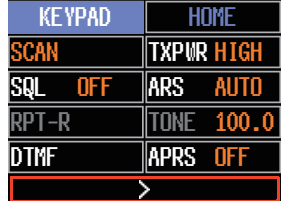

The memory channel list can also be displayed by the following operations.

1. Press and hold **[F MENU]** → **[18 MEMORY LIST]**
2. Press the **DIAL** knob.



3. Rotate the **DIAL** knob to select **[MEMORY CH]** then press the **DIAL** knob to display the memory channel list.

- Press the **[UP]** or **[DWN]** key on the microphone to select in 10 channel steps.
- Press the number keys on the microphone to quickly select a memory channel as shown in the example below:
Press the **[1]** key: Memory channel **100**
Press the **[A]** key: PMS Memory channel **L01**



4. Rotate the **DIAL** knob, select the memory channel to recall, then press the **DIAL** knob.

5. A pop-up with **[RECALL]** highlighted appears. Press the **DIAL** knob.

The selected memory channel will be recalled.

(3) Recalling a memory by directly entering the channel number

● Recalling a memory on the keypad screen

1. Press the [F MENU] key in the memory mode.
2. Press the **DIAL** knob.
Or press and hold the [F MENU] key → [1 FRERUENCY INPUT]
3. Rotate the **DIAL** knob to select a memory channel number, then press the **DIAL** knob.
(**Example**) When recalling memory channel “123”.
Rotate the **DIAL** knob to select [1] → Press the **DIAL** knob
↓
Rotate the **DIAL** knob to select [2] → Press the **DIAL** knob
↓
Rotate the **DIAL** knob to select [3] → Press the **DIAL** knob
(**Example**) When recalling memory channel “16”.
Rotate the **DIAL** knob to select [1] → Press the **DIAL** knob
↓
Rotate the **DIAL** knob to select [6] → Press the **DIAL** knob
↓
Press and hold the **DIAL** knob

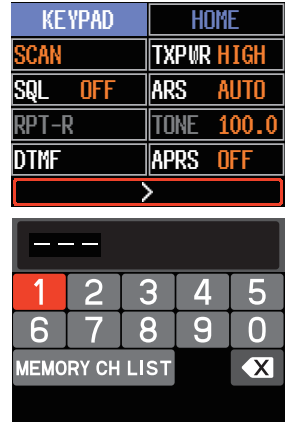

● Recall a memory by directly inputting channels using the numeric keys on the microphone

Press the numeric keys “0” to “9” in the memory mode to enter the memory channel.

(**Example**) When recalling memory channel “123”.

Press the [1] key.

↓
Press the [2] key.

↓
Press the [3] key.

(**Example**) When recalling memory channel “16”.

Press the [1] key.

↓
Press the [6] key.

↓
Press and hold any numeric key.

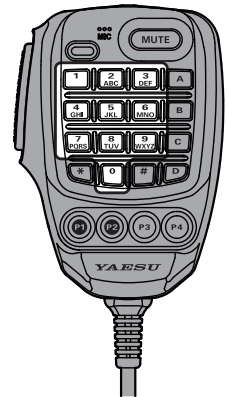

Press the **PTT** switch while entering a number to cancel the entry.

● Copy memory channel information to VFO

1. Press and hold the [BAND GRP] key while recalling memory.
Copy the contents of the recalled memory channel to the VFO and enter VFO mode.

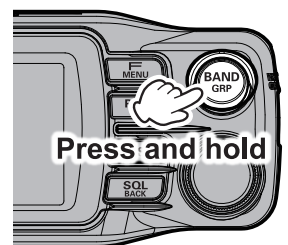

Memory list mode that automatically displays the memory channel list

Turning the **DIAL** knob in memory mode usually increases or decreases the memory channel number. Rotating the **DIAL** knob automatically displays the memory channel list and allows recalling the desired memory channel while checking the contents of the listed memory channels.

Setting

1. Press and hold the [**F MENU**] key → select [**19 MEMORY LIST MODE**] and press the **DIAL** knob.
2. Rotate the **DIAL** knob to select [**ON**].
3. To return to the normal operation screen from the Function List, press a key other than the power switch or **PTT**.

To return to normal up / down operation, set “**OFF**” in step 3 of the above operation.

Operation

1. When the **DIAL** knob is turned in the memory mode, the memory channel list is automatically displayed.
Press the [**BAND GRP**] key to switch to the display for each frequency band by the memory auto grouping (MAG) function (see below).
2. Rotate the **DIAL** knob to select the desired memory channel and press the **DIAL** knob.
3. The memory channel is recalled.

Recall only memories in the same frequency band (Band) using the memory auto grouping (MAG) function

With the memory auto grouping (**MAG**) function, only memory channels in the same frequency band (Band) can be called.

In the memory mode, each time the [**BAND GRP**] key is pressed, only memory channels of the specified frequency band are automatically recalled as a group, as shown below:

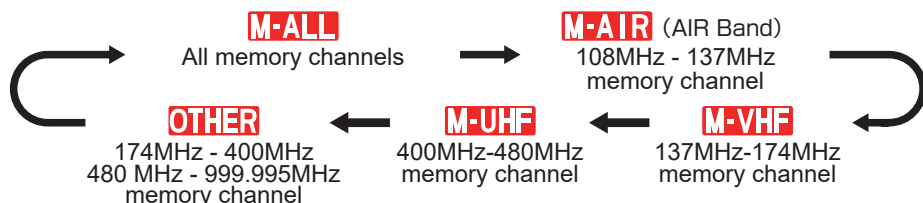
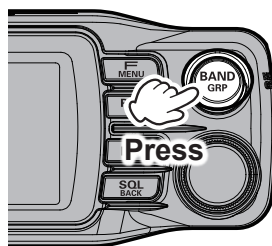

When “**M-ALL**” is selected, the MAG function is turned Off and all memory channels can be recalled.

Group	Selectable Memory Channels
M-ALL	All memory channels.
M-AIR (Blinking)	AIR band (108 - 137MHz) memory channels only.
M-VHF (Blinking)	144MHz band (137 - 174MHz) memory channels only.
M-UHF (Blinking)	430MHz band (400 - 480MHz) memory channels only.
OTHER (Blinking)	174MHz to 400MHz and 480MHz to 999.995MHz Memory channels

Edit memory

● Edit memory tag

Memory name tags, such as a call sign or broadcast station name may be assigned to the memory channels and home channels. Input a memory tag using up to 16 characters. Alphabetic characters (upper and lowercase), Numbers and Symbols may be entered to the memory name tag.

1. Press and hold the **[V/M mw]** key.

The memory channel list appears. The lowest available number is selected.



The memory channel list can also be displayed by the following operations:

Press the **[F MENU]** key → Select **[KEYPAD]** →

Press the **DIAL** knob → Select **[MEMORY CH LIST]** →

Press the **DIAL** knob

The last used memory channel is selected.

2. Rotate the **DIAL** knob to select the memory channel to edit the memory tag, then press the **DIAL** knob.
3. A popup will appear. Rotate the **DIAL** knob to select **[EDIT]** then press the **DIAL** knob. The memory information appears.

MEMORY CH LIST		
021	433.300	YAESU
022	433.620	FTM-200D
033	433.300	JA1YOE
041	433.100 433.200	DIGITAL

MEMORY CH LIST		
021	433.300	YAESU
022	433.620	FTM-200D
033	433.300	JA1YOE
041	433.100 433.200	DIGITAL

RECALL

WRITE

EDIT

DELETE

4. Rotate the **DIAL** knob to select **[TAG]**, then press the **DIAL** knob.

- The character input screen is displayed. Rotate the **DIAL** knob to select a character, and press the **DIAL** knob to enter the character.

← : moves the cursor to the left.

→ : moves the cursor to the right.

ABC : displays the alphabet keypad input screen.

123 : displays the numeric keypad input screen.

##% : displays the symbols keypad input screen.

✕ : erases the character to the left of the cursor and moves the cursor to the left.

- See “Text input screen” on page 76 to input a memory tag.

MEMORY INFORMATION	
RX FREQ	433.340
TX FREQ	111.111
TAG	
SCAN	YES
OK	BACK

a	b	c	d	e	f	h	h	i	j
k	l	m	n	o	p	q	r	s	t
u	v	w	x	y	z	Caps	A	あ	漢
123	##%	←	Space	→	✕				

- When input is complete, press and hold the **DIAL** knob to save the characters and return to **"MEMORY INFORMATION"** screen.
- Rotate the **DIAL** knob to select **[OK]**, then press the **DIAL** knob.
- A confirmation pop-up appears. Select **[OK]** then press the **DIAL** knob to complete the memory tag entry.



The Memory tag is only displayed on the operating band.

● Clearing Memories

- Press and hold the **[V/M mw]** key.
The memory channel list appears. The lowest available number is selected.

The memory channel list can also be displayed by the following operations:



Press the **[F MENU]** key → Select **[KEYPAD]** →
Press the **DIAL** knob → Select **[MEMORY CH LIST]** →
Press the **DIAL** knob
The last used memory channel is selected.



- Rotate the **DIAL** knob to select the memory channel from which the data is to be cleared, and press the **DIAL** knob.
- A pop-up appears. Rotate the **DIAL** knob to select **[DELETE]** then press the **DIAL** knob.
Confirmation screen **"DELETE?"** is displayed.
- Rotate the **DIAL** knob to select **[OK]**, then press the **DIAL** knob.



Memory channel 001 and home channel cannot be deleted.

Recalling the Home Channels

● Recall from the Function List

- Press the **[F MENU]** key.
- Rotate the **DIAL** knob, select **[HOME]**, then press the **DIAL** knob.
 - Or press and hold the **[F MENU]** key → **"17 HOME"**
 - "HOME"** and the home channel frequency of the currently selected band appears on the LCD.

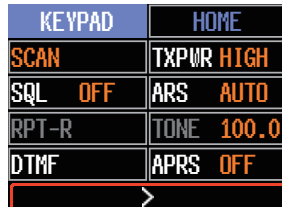

● Recall with the programmable key on the microphone

- Press the **[P2]*** key on the microphone.
* This is the factory setting. This function can also be assigned to the **[P3]** or **[P4]** key (see page 17).
"HOME" and the home channel frequency of the currently selected band appears on the LCD.
- Press the **[P2]** key again, to return to the previous frequency.

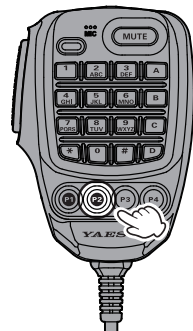

While recalling the home channel, rotate the **DIAL** knob to transfer the home channel frequency to the operating band VFO.

Changing the Home Channel Frequency

1. Set the frequency and the operating mode to be stored as a home channel.
2. Press the [F MENU] key.
3. Rotate the **DIAL** knob, select [HOME], then press and hold the **DIAL** knob.
“OVER WRITE HOME” will appear on the screen.
4. Rotate the **DIAL** knob to select [OK], then press the **DIAL** knob to overwrite the memory channel.

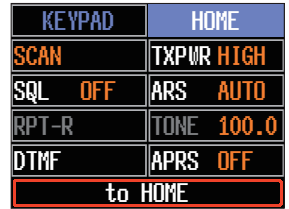

Select [HOM] in the writing procedure of the memory channel list to overwrite and save to the home channel.
See “Writing to Memory” on page 37.

Split Memory

Two different frequencies, one for receive and another for transmit, can be registered to a memory channel.

1. Register the receive frequency to a memory channel first.
For additional details on registering to a memory channel, refer to “Writing to memory” (page 37).
To edit a memory channel that has already been written, go to step 2.
2. Press and hold the [V/M MW] key.
The memory channel list appears.





The memory channel list can also be displayed by the following operations:
Press the [F MENU] key → Select [KEYPAD] → Press the **DIAL** knob →
Select [MEMORY CH LIST] → Press the **DIAL** knob
The last used memory channel is selected.

3. Rotate the **DIAL** knob to select the channel number that the receive frequency was registered to on step1, and press the **DIAL** knob.
4. Rotate the **DIAL** knob to select [EDIT], then press the **DIAL** knob.
5. Rotate the **DIAL** knob to select [TX FREQ], then press the **DIAL** knob.

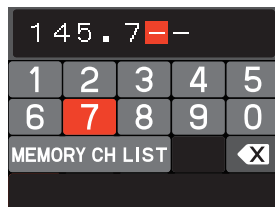

6. Rotate the **DIAL** knob to select a number, and press the **DIAL** knob to enter.
7. Rotate the **DIAL** knob to select [OK], then press the **DIAL** knob.



8. Confirmation screen is displayed, press the **DIAL** knob.
 - The edited memory channel is recalled.
 - When recalling split memory, the “” icon appears on the display.
 - On the memory channel list screen, the receive frequency is displayed on the upper area and the transmit frequency is displayed on the lower part of the split memory channel.

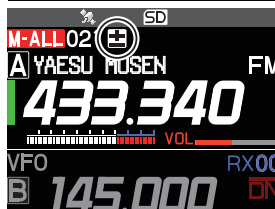

MEMORY CH LIST		
021	433.300	YAESU
022	433.620	FTM-200D
033	433.300	JA1YOE
041	433.100 433.200	DIGITAL



While operating the split memory, to reverse the transmit and receive frequencies temporarily:
 Press [F MENU] → Select [RPT-R]
 When reversing the frequencies, “” will blink.

PMG-SR (Single Receiver Primary Memory Group) Activity Monitor

By pressing and holding the **[PMG PW]** key, the current VFO or Memory Channel display frequency can be registered in the PMG group. Simply press the **[PMG PW]** key to call up the PMG screen and display the reception status of the registered channels in a bar graph.

Auto mode scans and stops at the channel with a signal to play the received audio. The scan resumes when there is no signal. When you press the **PTT** or **DIAL** knob to switch to manual mode, and turn the **DIAL** knob to fix receive to the selected channel, and play the received audio when there is a signal. When there is no signal on the selected channel, scan resume and displays the reception status of the other channels in real time. However, the received audio is not played even if there is a signal on the other channel. (On the PMG-SR screen, the real-time reception status of other channels is not displayed while the received audio of the manually selected channel is playing.)

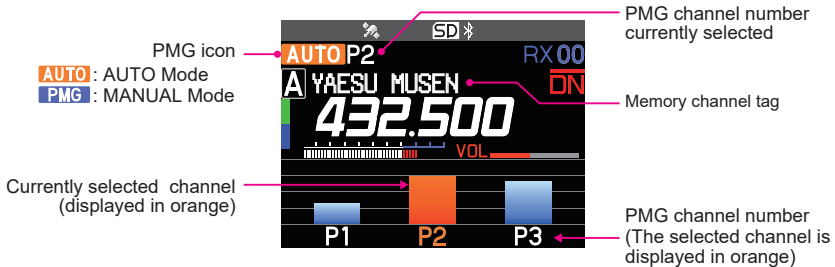

Example: When 3 frequencies are registered

Register the frequency to PMG

1. Set the frequency of the VFO or Memory Channel registered in the PMG.
2. Press and hold the **[PMG PW]** key to register the current frequency in PMG and immediately display the PMG activity monitor screen.
3. To continue registering additional frequencies, press the **[PMG PW]** key to return to the original screen, and then repeat steps 1 and 2 above.

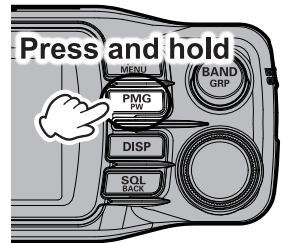

Call up the PMG screen

1. Press the **[PMG PW]** key to display the PMG screen. Press again to return to the original screen.

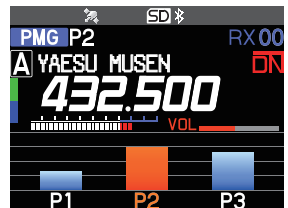

Switch between Auto Mode and Manual Mode

1. On the PMG screen, press the **DIAL** knob to switch each time between Auto Mode and Manual Mode.

AUTO : Auto Mode

PMG : Manual Mode

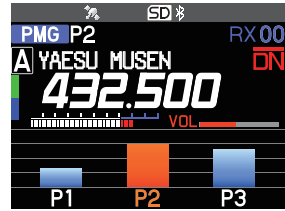

Auto Mode

- Scans channels registered in PMG continuously at high speed. (The PMG channel number flashes during scanning and there is no sound from the speaker.)

Operation example in Auto Mode



Since the PMG 3CH signal has disappeared, scanning is automatically resumed.

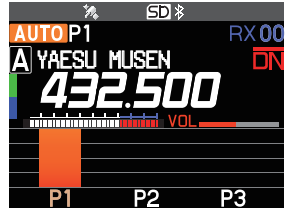

Receives signal with PMG 1CH and selects automatically

- Automatically stops at the channel with a signal and outputs the received audio. When a channel is active, the bar graphs of other channels pause and display the last reception state.
- When there is no signal, scanning will resume after about 1 second.
- When operating on the received channel, press the **PTT** or **DIAL** knob to switch to manual mode, which is fixed to the selected channel for communication.

Operation of Auto Mode

- Each time the **DIAL** knob is pressed, the Auto Mode and Manual Mode are toggled.
- Rotate the **DIAL** knob to change the channel while keeping the auto mode. If there is no signal on the selected channel, scanning will resume automatically after about 1 second.

Manual Mode

- The channel is fixed, and you can turn the DIAL knob to select the desired channel and communicate.
- If there is no signal on the selected channel, scanning continuously displays the reception status (signal strength) of other channels in a bar graph. (Received audio is not output even if there is a signal on another channel.)

Operation example in Manual Mode

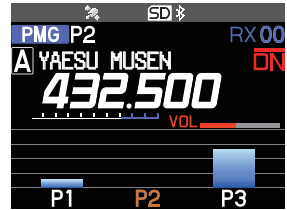

Since there is no signal on the selected PMG 2CH, the bar graph is displayed continuously.

- If there is a signal on the selected channel, the received audio is output. During audio output, the bar graphs of the other channels hold their last state and pause.
- When the signal on the selected channel concludes, scan is automatically restarted and the bar graph is displayed continuously.

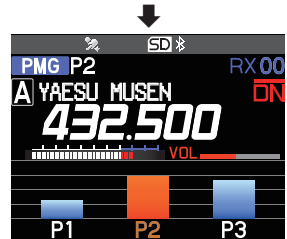

Since the signal was received by the selected PMG 2CH, the bar graph display is paused and the received sound is output.

Operation of Manual Mode

- In manual mode, the channel is fixed. Rotate the **DIAL** knob to select the desired channel.
- Press PTT to communicate with other stations on the selected PMG channel.
- Each time the **DIAL** knob is pressed, the auto mode and manual mode are toggled.

Unregister the channel (frequency) registered in PMG

Up to 5 channels can be registered in PMG. To register a new frequency, cancel the registration of one frequency and then register the new frequency.

1. Select the channel (frequency) to be unregistered by touching the bar graph or rotating the **DIAL** knob.
2. Press and hold the [**PMG PW**] key to cancel the registration.
 - Channels after the canceled channel have the previous number.
 - When all registered channels are lost, PMG will be canceled and the screen will return to the original screen.



Cancel all frequency (channels) registered in PMG.

1. Press and hold the [**F MENU**] key → [**20 PMG CLEAR**]
2. Press the **DIAL** knob.

Scanning Function

The FTM-200DR/DE supports the following three scanning functions:

- VFO Scan
- Memory Scan
- Programmable Memory Scan (PMS)

VFO Scan / Memory Scan

To find frequencies where there are signals in VFO mode or Memory mode:

1. Press the **[A/B]** key to set the band to be scanned as the operation band.
2. Press the **[V/M MW]** key to select the "VFO mode" or "Memory mode".
3. Press the **[F MENU]** key → "**SCAN**" → Press the **DIAL** knob. Or press and hold the microphone **[UP]** or **[DWN]** switch to start scanning.
 - If the **DIAL** knob is rotated while scanning is in progress, the scanning will continue up or down in frequency according to the direction of the **DIAL** Knob rotation.
 - When a signal is received, the scan pauses, the frequency flashes, and the scan starts again after about 3 seconds. In the USA version, the scan will continue to pause while receiving the signal.

KEYPAD	HOME
SCAN	TXPWR HIGH
SQL OFF	ARS AUTO
RPT-R	TONE 100.0
DTMF	APRS OFF
>	

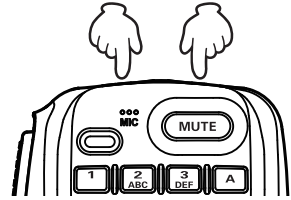

● Stop scanning

1. Press the **[F MENU]** key → "**SCAN**" → press the **DIAL** knob. Or press **PTT** or the **[UP]** / **[DWN]** keys on microphone.
 - If the scan has paused on a signal, rotating the **DIAL** knob will cause scanning to resume instantly.
 - If the transceiver is turned **OFF** while scanning, when the transceiver is turned **ON**, scanning will resume.
 - If you call the Function List or Setup Menu during scanning, the **SCAN** item is automatically selected and you cannot select any other item.



Setting the Receive Operation When Scanning Stops

1. Press and hold the **[F MENU]** key.
2. Rotate the **DIAL** knob to select **[53 SCAN RESUME]**, then press the **DIAL** knob.
3. Rotate the **DIAL** knob to select the hold time after the scan is paused:
 - **BUSY**
The signal is received until the signal fades out. Two seconds after the signal fades out, scanning resumes.

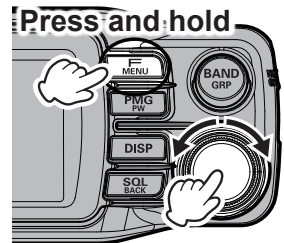

- **HOLD**

Scanning stops and tuning remains on the current receive frequency (Scanning does not resume).

- **1 sec / 3 sec / 5 sec**

The signal is received for a specified period of time, and then scanning resumes.

Factory default setting: **BUSY** (USA Version)

3 sec (except USA Version)

4. To return to the normal operation screen, press a key other than the power switch or **PTT**.



The above settings are common for VFO scan, memory scan and programmable memory scan (PMS).

Skip Memory Channels

Each memory channel can be set to be skipped during memory scan.

1. Press and hold the **[V/M MW]** key.

The memory channel list appears.



The memory channel list can also be displayed by the following operations:

Press the **[F MENU]** key → Select **[KEYPAD]** →

Press the **DIAL** knob → Select **[MEMORY CH LIST]** →

Press the **DIAL** knob

The last used memory channel is selected.

2. Rotate the **DIAL** knob to select the memory channel number that you do not want to scan, and press the **DIAL** knob.

3. Rotate the **DIAL** knob to select **[EDIT]**, then press the **DIAL** knob.

4. Rotate the **DIAL** knob to select **[SCAN]**.

5. Press the **DIAL** knob to select **[NO]**.

6. Rotate the **DIAL** knob to select **[OK]**, then press the **DIAL** knob.

7. When the confirmation screen is displayed, press the **DIAL** knob.

When the memory channel set as the skip memory is called, the “**X**” icon is displayed.



To cancel the skip memory, set it to “YES” in step 5 above.

Programmable Memory scan (PMS)

This function scans only the range of frequencies between the lower and upper limits registered in a pair of PMS Programmable Memory channels. 50 sets of PMS memory channels (L01/U01 to L50/U50) are available.



For additional details on the Programmable Memory Scan (PMS) and Memory Bank Scan, refer to the Advanced Manual which may be downloaded from the Yaesu website.

Convenience Features

Bluetooth® Operation

The FTM-200DR/DE can be equipped with the Bluetooth® function by installing the optional Bluetooth® unit “BU-4”. Remote operation is possible using the optional Bluetooth® headset (SSM-BT10) or a commercially available Bluetooth® headset.



The operation of all commercially available Bluetooth® headsets cannot be guaranteed.

Installing the Bluetooth® unit “BU-4”



Avoid touching the electronic components with your hands as the semiconductors may be damaged by static electricity.

1. Turn the transceiver **OFF**.
2. Unplug the control cable from the front panel.
3. Remove the eight screws from the front panel and then carefully lift the back case of the front panel.

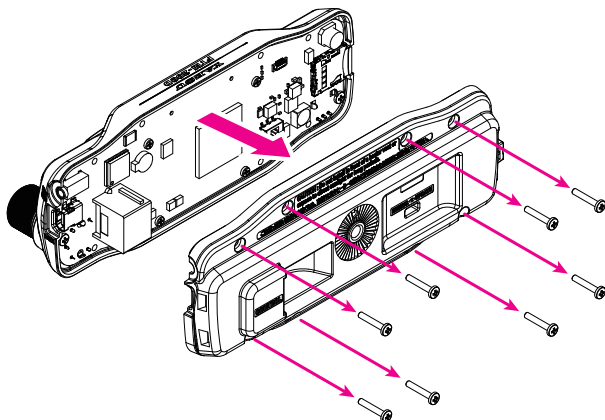

4. Align the BU-4 connector with the connector on the board and install.

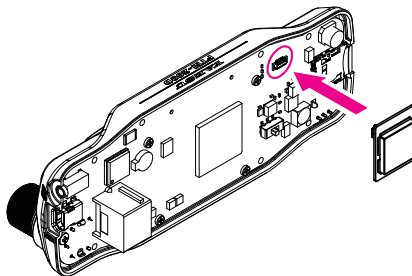

5. Carefully attach the back cover and secure it with the eight screws.

Pairing the Bluetooth® Headset

When using the Bluetooth® Headset for the first time, the Bluetooth® Headset and the FTM-200DR/DE must be paired.

This step is only necessary when first connecting the headset.

1. Press and hold the Multi-Function Button, until the SSM-BT10 LED blinks red/blue alternately. Press and hold the Multi Function Button for 3 seconds to turn ON.



2. Press and hold the [F MENU] key.

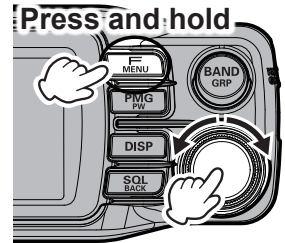

3. Rotate the **DIAL** knob to select [107 Bluetooth] then press the **DIAL** knob.

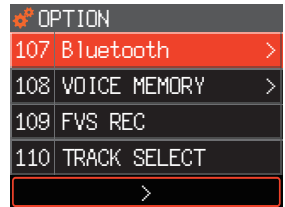

4. Press the **DIAL** knob and set [Bluetooth] to “ON”.
The setting items are displayed.
5. Press the **DIAL** knob.
6. Rotate the **DIAL** knob to select [DEVICE], then press the **DIAL** knob.

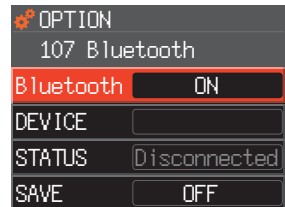

7. Press the **DIAL** knob.
The search starts, and the model name of the found Bluetooth® device is displayed in the list.
8. When the headset to be connected is displayed, press the [SQL BACK] key to stop searching.



9. Rotate the **DIAL** knob to select the Bluetooth® headset to be connected.
10. Press the [F MENU] key, then press the **DIAL** knob.

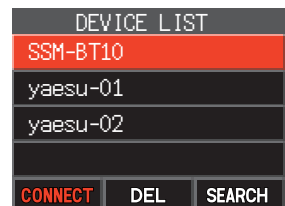

- When the connection is complete, the [DEVICE] field will display “Name of the connected Bluetooth® headset” and the [STATUS] field will display “Connected”.
- The LED of SSM-BT10 blinks blue. The pairing is completed.

OPTION	107 Bluetooth
Bluetooth	ON
DEVICE	SSM-BT10
STATUS	Connected
SAVE	OFF

11. To return to the normal operation screen, press a key other than the power switch or PTT.

While connected to a Bluetooth® headset, the “” icon lights up on the FTM-200DR/DE screen, and the received audio and operation beep will be heard from the Bluetooth® headset.

● Disable the Bluetooth® function

To cancel the Bluetooth® operation, just repeat the above procedures, selecting “OFF” in step 5 above.

● Subsequent Bluetooth® headset connection when the power is turned ON

- When the power is turned OFF while the Bluetooth® headset is connected, the next time the power is turned ON, the same Bluetooth® headset is searched for and automatically connected when found.
- If the Bluetooth® headset cannot be found, the “” icon blinks on the screen. If the power of the same Bluetooth® headset is turned ON in this state, it will connect automatically. If not, turn the FTM-200DR/DE and Bluetooth® headset OFF and then ON again.
- To connect to other Bluetooth® headsets, refer to “Connect with another Bluetooth® headset” on page 55.

Activate Transmit by pressing the button on the Bluetooth® headset (when the VOX function is OFF)

When the Multi-Function Key is pressed, a beep will sound and the FTM-200DR/DE will continuously transmit. Press the Multi-Function Key again, a beep will sound and the FTM-200DR/DE will return to receive mode.

Press briefly to transmit



Hands-free VOX operation with a Bluetooth® headset

When FTM-200DR/DE VOX (automatic voice transmission) function is turned ON, the Bluetooth® headset can perform hands-free operation and transmit automatically just by talking. Turn the VOX function ON according to “VOX Operation” instructions.



The VOX function is commonly used for the Bluetooth® headset and microphone. If you do not use the Bluetooth headset and do not want to use the VOX function with the microphone, set this to “OFF”.

VOX Operation

Using a Bluetooth® headset, you can transmit hands-free automatically, just by speaking into the microphone.



The VOX function does not activate with the optional camera-equipped microphone MH-85A11U.

Setting VOX function

1. Press and hold the [**F MENU**] key.
2. Rotate the **DIAL** knob to select [**11 VOX**] then press the **DIAL** knob.

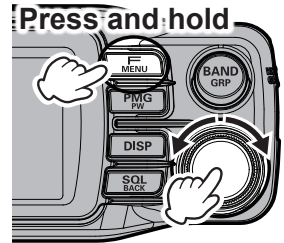

3. Press the **DIAL** knob again.
4. Rotate the **DIAL** knob to select “LOW” or “HIGH”.
OFF : VOX function OFF
LOW : VOX function ON (VOX Gain Level “LOW”)
HIGH : VOX function ON (VOX Gain Level “HIGH”)
 - Factory default value: “OFF”.
 - When set to “LOW” or “HIGH”, the audio is automatically transmitted from the connected Bluetooth® headset. When Bluetooth® function Off, the audio from the microphone is transmitted.

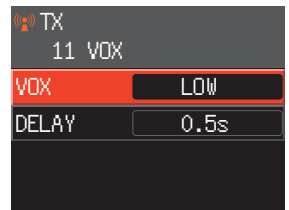

5. Press any key (except Power Switch) or **PTT** switch to finish the setting and return to the original screen.

● Disable the VOX function

To cancel VOX and return to **PTT** operation, just repeat the above procedures, selecting “**OFF**” in step 4 above.

Set the VOX (Voice Operated Transmit) delay time

During transmissions using the VOX (Voice Operated Transmit) function, set the time to return to receive when speaking is paused:

1. Press and hold the [F MENU] key.
2. Rotate the **DIAL** knob to select [11 VOX], then press the **DIAL** knob.
3. Rotate the DIAL knob to select [DELAY] then press the **DIAL** knob.
4. Rotate the **DIAL** knob to select the delay time (the transmit-receive delay after the cessation of speech).
0.5s / 1.0s / 1.5s / 2.0s / 2.5s / 3.0s
Factory default value: "0.5s".
5. Press the [DISP] key to complete the setting.

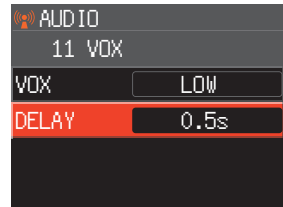
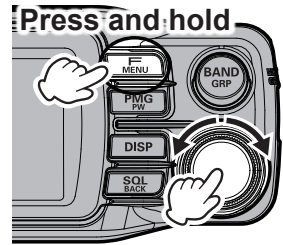

Bluetooth® battery save function

Turning ON the Bluetooth® Battery Saver feature extends the standby battery life of the Bluetooth® headset.

1. Press and hold the [F MENU] key.
2. Rotate the **DIAL** knob to select [Bluetooth], then press the **DIAL** knob.
3. Rotate the **DIAL** knob to select [SAVE], then press the **DIAL** knob to select "ON".
4. Press any key (except Power Switch) or **PTT** switch to finish the setting and return to the original screen.

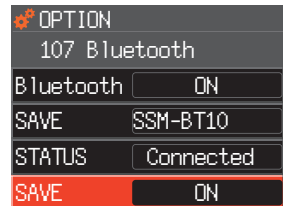
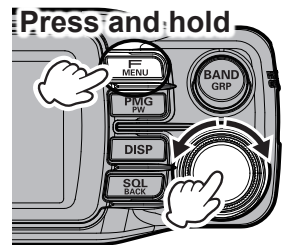

● Disable the battery save function

To cancel Bluetooth® Battery Saver feature, just repeat the above procedures, selecting "OFF" in step 3 above.

Connect with another Bluetooth® headset

1. Press and hold the **[F MENU]** key.
2. Rotate the **DIAL** knob to select **[107 Bluetooth]**, then press the **DIAL** knob.

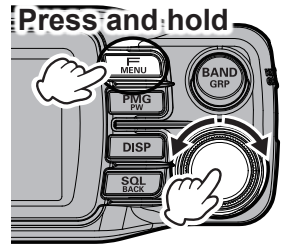

3. If the “STATUS” field shows “Connected”, rotate the **DIAL** knob to select **[STATUS]** then press the **DIAL** knob. “Disconnected” is displayed in the “STATUS” field.

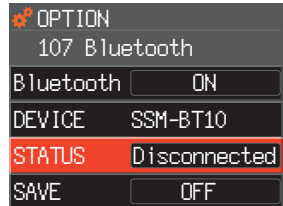

4. Rotate the **DIAL** knob to select **[DEVICE]**, then press the **DIAL** knob.
5. Press the **[F MENU]** key.
6. Rotate the **DIAL** knob to select **[SEARCH]**, then press the **DIAL** knob.



- Search Bluetooth® devices to display them in the device list in the following order:
 - (1) Already registered, searched and found Bluetooth® devices: white letters
 - (2) Searched and found new Bluetooth® devices: white letters
 - (3) Already registered but not found by search Bluetooth® devices: gray letters
- To interrupt the search, press the **[SQL BACK]** key.

7. When the headset to be connected is displayed, press the **[SQL BACK]** key to stop searching.
8. Rotate the **DIAL** knob to select the desired Bluetooth® device.
9. Press the **[F MENU]** key.
10. Rotate the **DIAL** knob to select **[CONNECT]**, then press the **DIAL** knob to connect.



● Connecting to a registered (paired) Bluetooth® headset

1. Perform step 4 above to display the device list.
2. Rotate the **DIAL** knob to select a Bluetooth® headset to connect to.
3. Press the **[F MENU]** key, then press the **DIAL** knob.
4. When the connection is completed, “Connected” is displayed in the STATUS” field.

● Remove a registered (paired) Bluetooth® device from the list

1. In step 2 above, rotate the **DIAL** knob to select the Bluetooth® headset to be deleted.
2. Press the **[F MENU]** key.
3. Rotate the **DIAL** knob to select **[DEL]**, then press the **DIAL** knob.
4. The Bluetooth® headset is deleted from the device list.

Bluetooth® received audio output

When a Bluetooth® headset is connected, the received audio can automatically be output from the headset only, or from both the headset and the transceiver speaker.

1. Press and hold the **[F MENU]** key.
2. Rotate the **DIAL** knob to select **[Bluetooth]**, then press the **DIAL** knob.

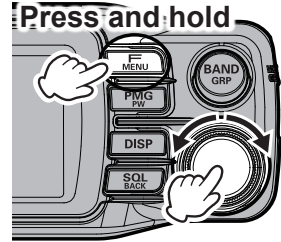

3. Rotate the **DIAL** knob to select **[AUDIO]**, then press the **DIAL** knob.
4. Rotate the **DIAL** knob to select “AUTO” or “FIX”.

AUTO : The received audio comes from only the Bluetooth headset.

FIX : The received audio comes from both the Bluetooth headset and the speaker of this transceiver.

Factory default value: “AUTO”.

5. Press any key (except Power Switch) or **PTT** switch to finish the setting and return to the original screen.

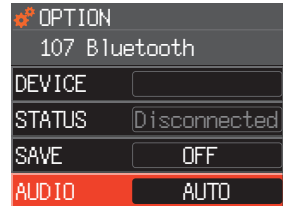

Band Scope

The Band Scope displays the current VFO frequency or Memory Channel at the center of a Bar graph with the signal status of a number of frequencies or channels displayed to the left and right at the bottom of the screen. The center frequency or memory channel can be changed by turning the **DIAL** knob.

When there is a signal on the center channel, the bar graph display of other frequencies is paused and you can hear the received audio. When there is no signal, the bar graph display is automatically resumed.

1. Press the **[DISP]** key to display the band scope.

VFO mode:

The status (strengths) of the signals in the upper and lower frequency channels (61CH or 31CH) centered on the current receive frequency are displayed in the bar graph.



The Band Scope frequency step is the same as the VFO frequency step.

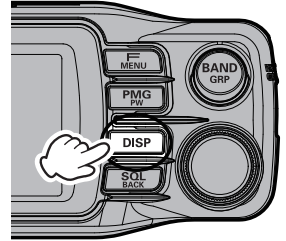

Memory mode:

- The status (strengths) of the signals in the upper and lower memory channels (21CH or 11CH) centered on the current memory channel are displayed in the graph.
- Memory channels that have not been registered are not displayed.
- The bar graph for the central memory channel is displayed in orange.

● Change frequency or Memory Channels

Rotate the **DIAL** knob to change the receive frequency or memory channel at the center of the band scope.

● Exit the Band Scope

Press the **[DISP]** key.

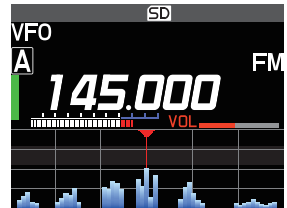

Display example
VFO Mode (61CH)

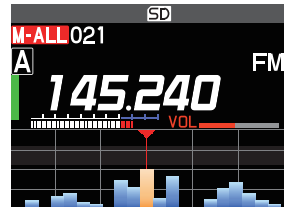

Display example
MEMORY Mode (21CH)

● Change the number of channels displayed

1. Press and hold the **[F MENU]** key.
2. Rotate the **DIAL** knob to select **[SCOPE]**, then press the **DIAL** knob.
3. Rotate the **DIAL** knob to select **“WIDE”** or **“NARROW”**.

The number of channels displayed in each mode is as follows:

	WIDE	NARROW
VFO mode	61 channels	31 channels
Memory mode	21 channels	11 channels

Factory default value: **“WIDE”**.

4. Press any key (except Power Switch) or **PTT** switch to conclude the the setting and return to the original screen.

Dual Receive Function

The transceiver is equipped with the following 2 types of Dual Receive Functions:

- **Home Channel Priority Scan**
- **A-B Dual Receive: The Operation Band and Sub Band are checked alternately at high speed**

Priority Scan

While receiving on the VFO or Memory Channel, the transceiver checks for signals on the HOME channel once every 5 seconds. When a signal is received on the HOME channel, the priority scan pauses, allowing reception of the signal. When there is no signal on the HOME channel for about 5 seconds, the transceiver will resume Priority Scan.

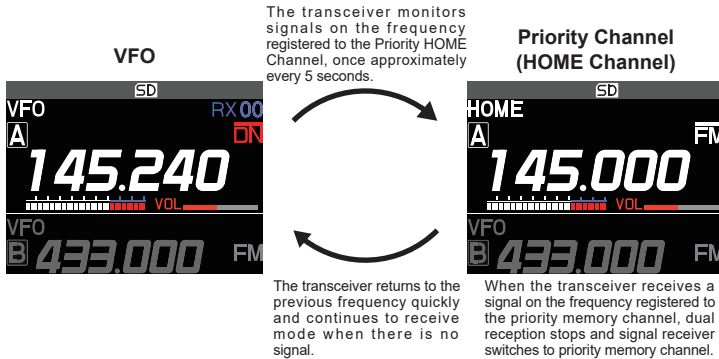

● Activating Priority Scan

1. Press and hold the [F MENU] key.
2. Rotate the **DIAL** knob to select [50 DUAL RCV MODE], then press the **DIAL** knob.
3. Rotate the **DIAL** knob to select [PRIORITY SCAN], then press the **DIAL** knob.
4. Press any key (except Power Switch) or **PTT** switch to finish the setting and return to the original screen.

● Disable the Priority Scan function

1. To cancel Priority Scan, just repeat the above procedures, selecting "OFF" in step 3 above.

A-B Dual Receive

Check if there is a signal that alternates between the operation band and the sub band at high speed. If there is a signal in either band, it will stop instantly and continue receiving, so simultaneous reception is not possible, but you can stand by in two bands. As soon as there is no signal, it returns to the original frequency and resumes A-B Dual Receive.

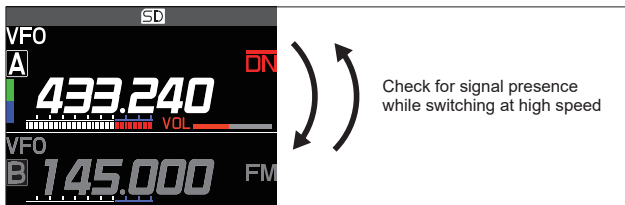

● Activating the A-B Dual Receive

1. Press and hold the [**F MENU**] key.
2. Rotate the **DIAL** knob to select [**50 DUAL RCV MODE**], then press the **DIAL** knob.
3. Rotate the **DIAL** knob to select [**A-B DUAL RECEIVE**], then press the **DIAL** knob.
4. Press any key (except Power Switch) or **PTT** switch to finish the setting and return to the original screen.

● Disable the A-B Dual Receive

1. To cancel A-B Dual Receive, just repeat the above procedures, selecting “**OFF**” in step 3 above.

Using the Voice Recorder

The voice recording function automatically starts recording when a signal is received, and pauses when there is no signal. Can be record the received audio of the other station or the transmitted audio of the FTM-200DR/DE to a microSD memory card for a long time. The recorded file can be played back with the FTM-200DR/DE or the MicroSD memory card can be taken out and used on a PC.

Once recording is started, it continues until recording is stopped, or the capacity of the microSD card is full.

● About the file

- The audio file is saved in the “VOICE” folder on the MicroSD card.
 - The file is a Wave sound format (extension: wav).
 - The file name is “YYYYMMDDmmhhss.wav” (YYYY: year, MM: month, DD: day, hh: hour, mm: minute, ss: second) depending on the date and time when the recording started.
-
- When using the MicroSD memory card for the first time, please refer to “Formatting a MicroSD Memory Card” on page 27
 - Since the date and time are used for the file name and time stamp, it is recommended to receive GPS or set the date and time in advance when using the voice recording function. Press and hold the [**F MENU**] key → [**28 DATE&TIME ADJUST**] (page 68)



Recording the receive audio

1. Press and hold the [**F MENU**] key.
2. Rotate the **DIAL** knob to select [**39 REC/STOP**], then press the **DIAL** knob.
“REC” is displayed, and the recording function starts.
3. Press any key (except Power Switch) or **PTT** to finish the complete the setting and return to the original screen.
 - “||” is displayed at the top of the LCD, the transceiver enters the recording standby mode.
 - When a signal is received, recording starts automatically. During recording, the “||” indication changes to “●”.
 - Recording will be paused about 3 seconds after the squelch of the band that is recording is closed. Recording will resume when a signal is received.
 - With the factory default settings, the “A-band” received audio is recorded.

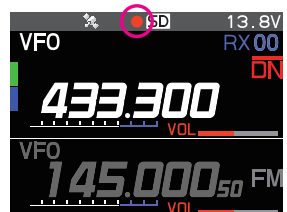
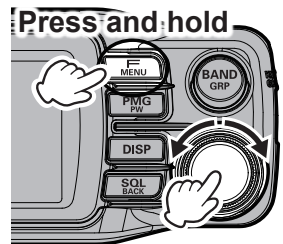

- The band or bands to be recorded, and whether or not to include the transmit audio in the recording may be selected in the Setup Menu.



Turning Off the power of the radio stops the recording function.

● Disable the recording function

1. Press and hold the [**F MENU**] key.
2. Rotate the **DIAL** knob to select [**39 REC/STOP**], then press the **DIAL** knob.
 - “STOP” is displayed and the recording function is stopped.
 - When a new recording is started, a new file will be created.

Setting the Recording function

The band or bands to be recorded, and whether or not to include the transmit audio in the recording may be selected. It cannot be changed during recording, so set them before stopping recording.

1. Press and hold the [**F MENU**] key.
2. Rotate the **DIAL** knob to select [**38 RECORDING**], then press the **DIAL** knob.
3. Press the **DIAL** knob again.
4. Rotate the **DIAL** knob to select the band to record.
 - A** : Record the A-band received audio
 - B** : Record the B-band received audio
 - A+B** : Record both A-band and B-band received audio



To record the received audio of a sub-band, the A-B dual receive function must be enabled. (See page 58)

5. Press the [**SQL BACK**] key.
6. Rotate the **DIAL** knob to select [**MIC**], then press the **DIAL** knob.
7. Rotate the **DIAL** knob to select “ON” or “OFF”.
 - ON** : Record both transmit and receive audio
 - OFF** : Record only the receive audio
8. Press any key (except Power Switch) or **PTT** switch to finish the setting and return to the original screen.

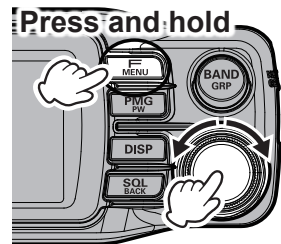

Playback the recorded audio



Playback is not possible during recording, so stop recording and follow the steps below to play back.

1. Press and hold the **[F MENU]** key.
2. Rotate the **DIAL** knob to select **[60 LOG LIST]**, then press the **DIAL** knob.

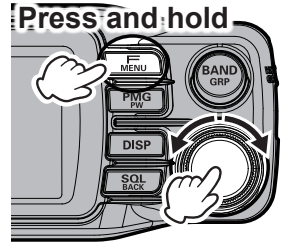

3. Rotate the **DIAL** knob to select **[VOICE]**, then press the **DIAL** knob.

- The recorded files will be displayed in a list.
- Press the **[F MENU]** key, then rotate the **DIAL** knob to select **[↓]**, and press the **DIAL** knob to display the Oldest file.
- Press the **[F MENU]** key, then rotate the **DIAL** knob to select **[TOP]**, and press the **DIAL** knob to display the latest file.

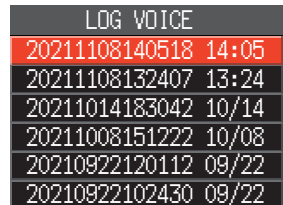

4. Rotate the **DIAL** knob to select the file to playback.



5. Press the **DIAL** knob.

- Playback will begin
- The receiver audio will not be heard during playback
- Play back while recording is not possible.

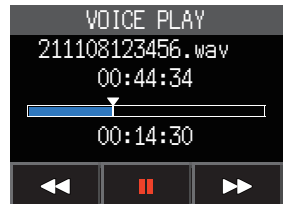

- Rotate the **DIAL** knob to select **[||]**, then press the **DIAL** knob to pause playback.
- Rotate the **DIAL** knob to select **[◀◀]** or **[▶▶]**, then press the **DIAL** knob, to rewind or fast forward 5 seconds at a time.

● Delete files

1. Rotate the **DIAL** knob in step 3 to select the file to be deleted, and then press the **[F MENU]** key.
2. Rotate the **DIAL** knob to select **[DEL]**, then press the **DIAL** knob.
3. Rotate the **DIAL** knob to select **[OK]**, then press the **DIAL** knob.

Taking a Picture (Snapshot Function)

Pictures can be taken by connecting the optional camera-equipped microphone (MH-85A11U). Captured image data can be saved onto a MicroSD memory card inserted into the transceiver. The saved data can be displayed on the screen and transmitted to other transceivers* as well. In addition, the most recently captured image data can be transmitted to other transceivers* by pressing  (Send Image Button) on the camera-mounted microphone.

* Refer to the Yaesu website or catalog for the compatible transceiver models.

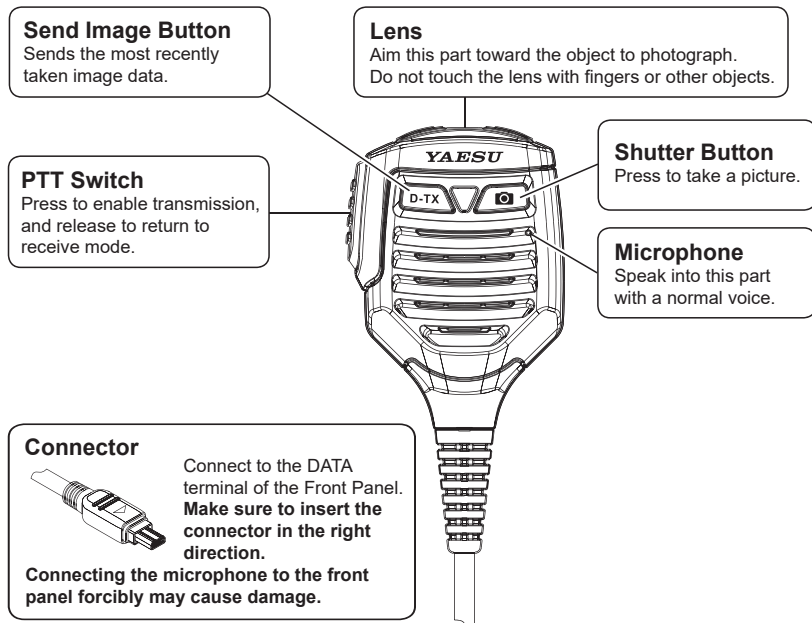

- Make sure to keep at least 20 inches (50cm) distance between the lens and the object. If the object is too close, the picture will be out of focus, resulting in a blurred picture.
- You can set the size (resolution) and image quality (compression ratio) of the image to be shot by the following operations:
Press and hold the [F MENU] key → [115 USB CAMERA]
- If your station and the remote station are both in digital mode, you can transfer the image data most recently taken by pressing .
- Set the digital mode in advance to transfer images to other radios.
- Do not directly photograph objects with strong light, such as the sun or other bright objects. Doing so can cause malfunction.
- If the lens or the microphone gets dirty, use a dry, soft cloth to wipe off the contaminants.





! "MH-85A11U" cannot be transmitted by the VOX function.

Taking pictures

1. Turn the transceiver **OFF**.
2. Connect the camera-equipped microphone (MH-85A11U) to the DATA terminal of the front panel.



Turn the transceiver OFF when connecting or disconnecting the MH-85A11U.

3. Press the  (shutter button) on the MH-85A11U microphone to take a picture.
 - The captured image appears on the Display.
 - Press the [**F MENU**] key, to temporarily turn OFF the display of [**SAVE**], [**SEND**], [**EDIT**] and view the entire photo. Press the [**F MENU**] key again to display [**SAVE**], [**SEND**], [**EDIT**].
4. To save the image onto the MicroSD memory card, rotate the **DIAL** knob to select [**SAVE**], then press the **DIAL** knob.
Press the [**SQL BACK**] key to return the display to the previous operating screen without saving the image.
5. To transmit the saved image to other transceivers, press the  (Send Image Button) on the MH-85A11U.



Press the microphone **PTT** switch to cancel the picture transmission (it may take a while for the transmission to be canceled).

Viewing the Saved Image

1. Press and hold the [**F MENU**] key.
2. Rotate the **DIAL** knob to select [**60 LOG LIST**], then press the **DIAL** knob.
3. Rotate the **DIAL** knob to select [**PICT**], then press the **DIAL** knob.
Displays the saved image data list.
 - Press the [**F MENU**] key, then rotate the **DIAL** knob to select [**↕**], and press the **DIAL** knob to display the oldest file.
 - Press the [**F MENU**] key, then rotate the **DIAL** knob to select [**TOP**], and press the **DIAL** knob to display the latest file.
4. Rotate the **DIAL** knob to select the image to be displayed, then press the **DIAL** knob.
 - The image will be displayed.
 - Rotate the **DIAL** knob to display other saved images.
 - Press the **DIAL** knob while an image is displayed, you can temporarily turn Off the display information other than the image, such as the file name, and view the entire photo. Press the **DIAL** knob again to display it again.
5. Press the [**F MENU**] key.
6. Rotate the **DIAL** knob to select [**SEND**], then press the **DIAL** knob.
The confirmation screen will be displayed.
7. Rotate the **DIAL** knob to select [**OK**], then press the **DIAL** knob.
Image transmission starts.
8. Press the **PTT** switch to return to the normal screen.

Deleting saved images

1. Select **[DEL]** in step 6 above and press the **DIAL** knob.
The confirmation screen will be displayed.
2. Rotate the **DIAL** knob to select **[OK]**, then press the **DIAL** knob.
The image is deleted.

Edit the tag (display name) of the saved image

1. Select **[EDIT]** in step 6 above and press the **DIAL** knob.
The image tag (display name) edit screen is displayed.
2. Rotate the **DIAL** knob to select a character and press the **DIAL** knob to confirm.
3. Repeat step 2 to edit the image tag (display name).
4. When you have finished editing, press and hold the **DIAL** knob.
The image tag (display name) is changed.

GPS Function

The FTM-200DR/DE is equipped with a GPS (Global Positioning System) receiver. When receiving signals from GPS satellites, the current position (latitude, longitude, altitude) can be calculated and displayed within a tolerance of several meters. In addition, GPS receives the exact time from the satellite atomic clock.



For additional details on the GPS Function, refer to the Advanced Manual which may be downloaded from the Yaesu website.

WIRES-X function

WIRES (Wide-coverage Internet Repeater Enhancement System) is an Internet communication system which expands the range of amateur radio communications by connecting with a local WIRES-X Node station. The FTM-200DR/DE can communicate and exchange data via the internet with WIRES-X nodes worldwide. Use the News Station function to write (upload) and read (download) digital data (text, images and audio). When connected to a WIRES-X node station or room, the node name, room name, call sign of the other station, distance, and direction, are all displayed on this screen.



For details, refer to the separate WIRES-X Instruction Manual which is available on the Yaesu website.

APRS (Automatic Packet Reporting System) function

The FTM-200DR/DE uses a GPS receiver to acquire and display its position location information. The APRS feature uses the location information to transmit the position information, data and messages, using the format developed by Bob Bruninga WB4APR. Upon receiving an APRS report from a remote station, the direction and distance to the remote station from your station, the speed of the remote station, and other data sent by the remote station may be displayed on the LCD of your transceiver.

Setting several station parameters, such as the call sign and symbol is required before using the APRS function (initial settings).



For details, refer to the APRS Function Instruction Manual which is available on the Yaesu website.



For additional details on the following Functions, refer to the Advanced Manual which may be downloaded from the Yaesu website.

Digital Personal ID (DP-ID) feature

Digital Personal ID (DP-ID) feature opens the speaker audio only when a C4FM signal set to the same DP-ID in the Digital Mode is received.

Tone squelch feature

The tone squelch opens the speaker audio only when a signal containing the specified CTCSS tone is received. By matching the CTCSS tone frequency with the partner stations, quiet standby monitoring is possible.

Digital Code squelch (DCS) feature

The DCS (Digital Coded Squelch) function allows audio to be heard only when signals containing the same DCS code are received.

New PAGER (EPCS) feature

This new feature allows calling specified stations only, by using a pager code that combines two CTCSS tones. Even when the person who is called is not near the transceiver, the information is displayed on the LCD to indicate that a call was received. When the call is received, the bell sounds.

Using Setup Menu

The Set Mode permits configuring the various functions to accommodate individual operating needs and preferences.

Setup Menu Operation

1. Press and hold the **[F MENU]** key.
The Setup Menu screen will be displayed.

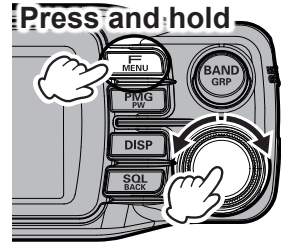

2. Rotate the **DIAL** knob to select the desired item in the Setup Menu, then press the **DIAL** knob.
 - Press the **[SQL BACK]** key to return to the previous screen.
 - Press the **[UP]** / **[DWN]** key on the microphone to jump to the 17 categories in the Setup Menu below.

☐ **DISPLAY** ↔ 📶 **TX** ↔ 📶 **RX** ↔ ☐ **MEMORY** ↔
👤 **CONFIG** ↔ 📶 **AUDIO** ↔ 📶 **SIGNALING** ↔
🔄 **SCAN** ↔ 📶 **DIGITAL** ↔ 👤 **GM** ↔ 📶 **WIRES-X** ↔
📶 **DATA** ↔ 🌐 **APRS** ↔ ☐ **SD CARD** ↔ ⚙️ **OPTION**
↔ → **CLONE** ↔ ↺ **RESET**

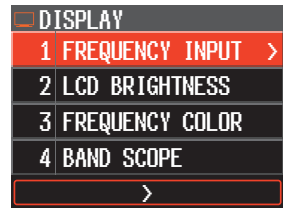

3. When there is no deeper level of menu items, go to step 4.
When there is a deeper level of menu items, rotate the **DIAL** knob to select the desired item, then press the **DIAL** knob.
4. Rotate the **DIAL** knob to change the setting value.
5. Press any key (except Power Switch) or **PTT** switch to finish the setting and return to the original screen.

Tables of Setup Menu Operations

Menu Number / Item	Description	Selectable options (Options in bold are the default settings)
--------------------	-------------	--

DISPLAY

1 FREQUENCY INPUT	Enter frequency directly or display memory channel list.	-
2 LCD BRIGHTNESS	Display and key button brightness.	MIN / MID / MAX
3 FREQUENCY COLOR	Set the font color of the operation band frequency.	WHITE / BLUE / RED
4 BAND SCOPE	Scope Display width setting.	NARROW / WIDE
5 LOCATION INFO	Switch between the compass screen and the latitude/longitude display screen when using the GPS and GM functions.	COMPASS / NUMERIC
6 COMPASS	Set the compass display of the smart navigation function.	NORTH UP / HEADING UP
7 DISPLAY MODE	Back Track, Altitude, Timer/Clock or GPS Information screen display.	BACKTRACK / ALTITUDE / TIMER/CLOCK / GPS INFORMATION

TX

8 TX POWER	Set the transmit power level.	LOW / MID / HIGH
9 AMS TX MODE	Set the AMS transmission mode.	AUTO / TX FM FIXED/ TX DN FIXED
10 MIC GAIN	Microphone sensitivity setting.	MIN / LOW / NORMAL / HIGH / MAX
11 VOX	VOX function settings.	VOX: OFF / LOW / HIGH DELAY: 0.5s / 1.0s / 1.5s / 2.0s / 2.5s / 3.0s
12 AUTO DIALER	DTMF code automatic transmit setting.	ON / OFF
13 TOT	TX time out setting.	OFF / 1min / 2min / 3min / 5min / 10min / 15min / 20min / 30min (Depends on the transceiver version)
14 DIGITAL VW	Turn the VW mode selection ON or OFF.	ON / OFF

RX

15 FM BANDWIDTH	Set the FM transmit modulation level.	WIDE / NARROW
16 RX MODE	Select the receive mode.	AUTO / FM / AM

MEMORY

17 HOME	Recall the home channel.	Depends on the transceiver version.
18 MEMORY LIST	Displays the Memory channel list screen.	-
19 MEMORY LIST MODE	Displays a list of memory channels in memory mode.	ON / OFF
20 PMG CLEAR	Cancel the registration of all PMG channels.	-

CONFIG

21 BEEP	Beep volume setting.	OFF / LOW / HIGH
----------------	----------------------	-------------------------

Menu Number / Item	Description	Selectable options (Options in bold are the default settings)
22 BAND SKIP	Set the frequency bands that can be selected.	AIR: ON / OFF VHF: ON / OFF UHF: ON / OFF OTHER: ON / OFF
23 RPT ARS	Repeater auto shift setting.	OFF / AUTO
24 RPT SHIFT	Repeater shift direction setting.	AUTO / - / +
25 RPT SHIFT FREQ	Repeater TX offset setting.	0.00MHz to 99.95MHz
26 RPT REVERSE	Reverses the transmit and receive frequencies while working through a repeater.	NORMAL / REVERSE
27 MIC PROGRAM KEY	Microphone P2 / P3 / P4 buttons programmable settings.	OFF / REC(STOP) / SCAN / HOME / RPT SHIFT / REVERSE / TX POWER / SQL OFF / T-CALL / VOICE* / D_X / WX / STN LIST / MSG LIST / REPLY / MSG EDIT / DW (*requires optional FVS-2) P1: GM (FIX) P2: HOME P3: D_X P4: WX (T-CALL: European version)
28 DATE&TIME ADJUST	Set the date and time.	-
29 DATE&TIME FORMAT	Set the date and time display formats.	Date: mmm/dd/yyyy / yyyy/mmm/dd / dd/mmm/yyyy / yyyy/dd/mmm Time: 24hours / 12hours
30 TIME ZONE	Time zone setting.	UTC -14:00 to ±0:00 to +14:00
31 STEP	Frequency tuning step.	AUTO / 5.00 kHz / 6.25 kHz / (8.33 kHz) / 10.00 kHz / 12.50 kHz / 15.00kHz / 20.00kHz / 25.00 kHz / 50.00 kHz / 100 kHz
32 CLOCK TYPE	Clock shift setting.	A / B
33 UNIT	Display unit setting.	METRIC / INCH (Depends on the transceiver version)
34 APO	Automatic power OFF time setting.	OFF / 0.5hour to 12.0hour (0.5 hour steps)
35 GPS DATUM	GPS function positioning selection.	WGS-84 / TOKYO MEAN
36 GPS DEVICE	GPS receiver selection.	INTERNAL / EXTERNAL
37 GPS LOG	GPS access time setting.	OFF / 1sec / 2sec / 5sec / 10sec / 30sec / 60sec

AUDIO

38 RECORDING	Voice record function settings.	BAND: A / B / A+B MIC: ON / OFF
39 REC/STOP	Start and stop recording.	-

SIGNALING

40 DTMF	Load DTMF Autodialer Memories.	-
41 DTMF MEMORY	Set the DTMF auto dialer channel and code (16 characters).	1 to 9
42 SQL TYPE	Select a squelch type.	OFF / TONE ENC / TONE SQL / REV TONE / DCS / PR FREQ / PAGER / (DCS ENC) / (TONE DCS) / (DCS TSQL) *The options in the parentheses are available when the SQL expansion is ON.

Menu Number / Item	Description	Selectable options (Options in bold are the default settings)
43 TONE SQL FREQ or DCS CODE	Set the CTCSS Tone Frequency or the DCS code.	CTCSS: 67.0Hz to 254.1Hz (100Hz) DCS: 023 to 754
44 SQL EXPANSION	Separate squelch type setting for transmit and receive.	ON / OFF
45 PAGER CODE	Pager individual code settings.	RX-CODE 1: 01 - 05 - 50 RX-CODE 2: 01 - 47 - 50 TX-CODE 1: 01 - 05 - 50 TX-CODE 2: 01 - 47 - 50
46 PR FREQUENCY	User programmed reverse tone frequency.	300Hz - 1500Hz - 3000Hz
47 BELL RINGER	Recall sound length setting.	OFF / 1 time / 3 times / 5 times / 8 times / CONTINUOUS
48 WX ALERT	Weather alert operation setting.	ON / OFF

 SCAN		
49 SCAN	Engages the Scan operation.	-
50 DUAL RCV MODE	Dual receive operation setting.	OFF / PRIORITY SCAN / A-B DUAL RECEIVE
51 DUAL RX INTRVAL	Dual receive reception interval setting. (Only enabled when "34 Dual Receive Mode" is set to "PRIORITY SCAN".)	0.5sec / 1sec / 2sec / 3sec / 5sec / 7sec / 10sec
52 PRIORITY REVERT	The transmission operation during dual receive always transmits on the home channel.	OFF / ON
53 SCAN RESUME	Set the resume operation after scanning stops on a signal.	BUSY / HOLD / 1sec / 3sec / 5sec (Depends on the transceiver version)

 DIGITAL		
54 DIGITAL POPUP	Information screen popup time.	OFF / 2sec / 4sec / 6sec / 8sec / 10sec / 20sec / 30sec / 60sec / CONTINUE
55 LOCATION SERVICE	Set whether to send your current location in digital mode.	ON / OFF
56 STANDBY BEEP	Standby Beep setting.	ON / OFF

 GM		
* Refer to the separate Operating Manual GM Edition for details on the functions.		
57 DP-ID LIST	Displays the DP-ID list screen.	-
58 RANGE RINGER	Set the bell sound when checking for stations within sphere of communications.	ON / OFF
59 RADIO ID	Specific transceiver ID is displayed.	- (cannot be edited)
60 LOG LIST	Display a list of recorded voices, received messages and images.	-

Menu Number / Item	Description	Selectable options (Options in bold are the default settings)
--------------------	-------------	--

WIRES-X

* Refer to the separate Operating Manual WIRES-X Edition for details on the functions.

61 RPT/WIRES FREQ	Set the frequency to be used for Repeater / WIRES-X.	MANUAL / PRESET
FREQUENCY	Register the WIRES-X preset frequency.	Preset frequency: 146.550MHz 446.500MHz
62 SEARCH SETUP	Set the WIRES ROOM selection method.	HISTORY / ACTIVITY
63 EDIT CATEGORYTAG	Edit the category tag.	C1 to C5
64 DELETE ROOM/NODE	Delete a registered category.	C1 to C5
65 WIRES DG-ID	Set the DG-ID number for WIRES-X.	AUTO / 01 to 99

DATA

66 COM PORT	COM port settings	SPEED: 4800bps / 9600bps / 19200bps / 38400bps / 57600bps OUTPUT: OFF / GPS OUT / PACKET /WAYPOINT WP FORMAT: NMEA 6 / NMEA 7 /NMEA 8 / NMEA 9 WP FILTER: ALL / MOBILE / FREQUENCY / OBJECT/ITEM / DIGIPEATER / VoIP / WEATHER /YAESU / CALL RINGER / RANGE RINGER
67 DATA BAND	APRS/DATA band selection settings.	APRS: MAIN BAND / SUB BAND / A-BAND FIX / B-BAND FIX / DATA: MAIN BAND / SUB BAND / A-BAND FIX / B-BAND FIX /
68 DATA SPEED	APRS/DATA communication baud rate settings.	APRS: 1200 bps / 9600 bps DATA: 1200 bps / 9600 bps
69 DATA SQL	Squelch detection settings.	TX ON / TX OFF

APRS

* Refer to the separate Operation Manual APRS Edition for details on the functions.

70 APRS DESTINATION	Model code display Non-editable.	APY200 (FIX)
71 APRS FILTER	Filter function settings.	Mic-E: ON / OFF POSITION: ON / OFF WEATHER: ON / OFF OBJECT: ON / OFF ITEM: ON / OFF STATUS: ON / OFF OTHER: ON / OFF RANGE LIMIT: ON / OFF ALTNET: ON / OFF

Menu Number / Item	Description	Selectable options (Options in bold are the default settings)
72 APRS MSG TXT	Standard message text input.	1 to 8 channels
73 APRS	Set APRS function ON/OFF.	OFF / ON
74 APRS MUTE	Set band B APRS audio mute.	OFF / ON
75 APRS POPUP	Beacons and messages Pop-up display time setting.	BEACON: OFF / 3sec / 5sec / 10sec / HOLD MESSAGE: OFF / 3sec / 5sec / 10sec / HOLD MYPACKET: OFF / ON
76 APRS RINGER	Set bell sound when beacons are received.	TX BEACON: ON / OFF TX MESSAGE: ON / OFF RX BEACON: ON / OFF RX MESSAGE: ON / OFF MY PACKET: ON / OFF CALL RINGER: ON / OFF RANGE RINGER: OFF / 1 / 5 / 10 / 50 / 100 (km / mi) MSG VOICE: ON / OFF
77 APRS RINGER (CS)	Call sign setting for CALL RINGER.	1 - 8 stations
78 APRS TX DELAY	Data transmit delay time setting.	100ms / 150ms / 200ms / 250ms / 300ms / 400ms / 500ms / 750ms / 1000ms
79 APRS UNITS	APRS display unit settings.	POSITION: dd°mm.mm' / dd°mm'ss" DISTANCE: km / mile SPEED: km/h / mph / knot ALTITUDE: m / ft BARO: hPa / mb / mmHg / inHg TEMP: °C / °F RAIN: mm / inch WIND: m/s / mph / knot
80 BEACON INFO	Transmit beacon information settings.	AMBIGUITY: OFF / 1 digit / 2 digits / 3 digits / 4 digits SPEED/COURSE: ON / OFF ALTITUDE: ON / OFF
81 BEACON STATUSTXT	Status text input settings.	SELECT: OFF / TEXT 1 - 5 TX RATE: 1/1 - 1/8 / 1/2(FREQ)- 1/8(FREQ) TEXT 1 - 5: NONE / FREQUENCY / FREQ & SQL & SHIFT
82 BEACON TX SET	Beacon automatic transmit / Manual transmit switch.	AUTO: OFF / ON / (SmartBeaconing)* INTERVAL: 30 sec - 5 min - 60 min PROPORTIONAL: ON / OFF DECAY: ON / OFF LOW SPEED: 1 - 3 - 99 (km / mph / knot) RATE LIMIT: 5 sec - 30 sec - 180 sec * The option in the parentheses is available when the "97 SmartBeaconing" is TYPE1, TYPE 2 or TYPE 3, and the "93 MY POSITION SET" is GPS.
83 DIGI PATH	Digital repeater route setting.	OFF / WIDE1-1 / WIDE1-1 , WIDE2-1 / PATH 1 / PATH 2 / PATH 3 / PATH 4 / FULL 1 / FULL 2

Menu Number / Item	Description	Selectable options (Options in bold are the default settings)
84 DIGI PATH 1	Digital repeater route address setting.	ADDRESS 1: - ADDRESS 2: -
85 DIGI PATH 2		
86 DIGI PATH 3		
87 DIGI PATH 4		
88 DIGI PATH FULL 1	Digital repeater route address setting.	ADDRESS 1: - to ADDRESS 8: -
89 DIGI PATH FULL 2		
90 CALLSIGN (APRS)	My call sign setting.	***** - **
91 MESSAGE GROUP	Group filter setting for received messages.	GROUP 1: ALL***** GROUP 2: CQ***** GROUP 3: QST***** GROUP 4: YAESU**** GROUP 5: ----- GROUP 6: ----- BULLETIN 1: BLN?***** BULLETIN 2: BLN?----- BULLETIN 3: BLN?-----
92 MESSAGE REPLY	Set automatic response to received messages.	REPLY: OFF / ON CALLSIGN: *****_* REPLY TEXT: -
93 MY POSITION SET	My position setting.	GPS / MANUAL
94 MY POSITION	My position manual setting.	LAT: N 0°00. 00' (° 00") LON: E 0°00. 00' (° 00")
95 MY SYMBOL	My symbol setting.	ICON 1: [/>] Car ICON 2: [/R] REC.Vehicle ICON 3: [/.] House QTH (VHF) USER: [YY] Yaesu Radios
96 POSITION COMMENT	Set position comment.	Off Duty / En Route / In Service / Returning / Committed / Special / Priority / Custom 0 to Custom 6 / EMERGENCY!
97 SmartBeaconing	Smart beaconing settings.	STATUS: OFF / TYPE1 / TYPE2 / TYPE3 * For details on the following setting items for each type, refer to the APRS Instruction Manual. LOW SPD, HIGH SPD, SLOW RATE, FAST RATE, TURN ANGL, TURN SLOP, TURN TIME
98 SORT FILTER	Sort function / Filter function settings.	SORT: TIME / CALLSIGN / DISTANCE FILTER: ALL / MOBILE / FREQUENCY / OBJECT / ITEM / DIGIPEATER / VoIP / WEATHER / YAESU / OTHER PACKET / CALL RINGER / RANGE RINGER / 1200 bps / 9600 bps
99 VOICE ALERT	Voice alert function settings.	VOICE ALERT: NORMAL / TONE SQL DCS / RX-TSQL / RX-DCS TONE SQL: 67.0Hz - 100.0Hz - 254.1Hz DCS: 023 - 754
100 STATION LIST	Displays the APRS Station list screen.	-

Menu Number / Item	Description	Selectable options (Options in bold are the default settings)
101 MESSAGE LIST	Displays the APRS Message list screen.	–
102 BEACON TX SELECT	Beacon automatic transmit / Manual transmit switch.	MANUAL / AUTO / (SmartBeaconing)* * The option in the parentheses is available when the "97 SmartBeaconing" is TYPE1, TYPE 2 or TYPE 3, and the "93 MY POSITION SET" is GPS.
103 BEACON TX	Manual beacon transmission (one time)	–

SD CARD

104 BACKUP		
WRITE TO SD	Saves the transceiver setting information to a microSD memory card.	
ALL MEMORY SETUP	Copies all data. Copies only the memory channels and backtrack position information. Copies only the set-up menu settings.	
READ FROM SD	Loads the information to the transceiver from a microSD memory card.	
ALL MEMORY SETUP	Copies all data. Copies only the memory channels and backtrack position information. Copies only the set-up menu settings.	
105 MEMORY INFO	Displays the total capacity and free space of the MicroSD Card.	–
106 FORMAT	Initializing the micro-SD card.	–

OPTION

107 Bluetooth (Requires optional Bluetooth® Unit BU-4)		
Bluetooth	Bluetooth headset setting.	OFF / ON
DEVICE	Bluetooth device list.	–
SAVE	Turn the Bluetooth save function ON or OFF.	OFF / ON
AUDIO	Set whether received audio is heard from both the Bluetooth® headset and the transceiver speaker, or only from the connected Bluetooth® device.	AUTO / FIX
108 VOICE MEMORY (Requires optional Voice Guide Unit FVS-2)		
PLAY/REC	Recording operation settings.	FREE 5min / LAST 30sec
ANNOUNCE	Setting conditions for frequency announcement.	AUTO / OFF / MANUAL
LANGUAGE	Setting the language to announce.	ENGLISH / JAPANESE
VOLUME	Setting the announcement volume.	HIGH / MID / LOW
RX MUTE	Setting to mute received audio during announcements and playback.	ON / OFF
109 FVS REC	Start recording the received audio.	–
110 TRACK SELECT	Selecting the audio track to play.	ALL / 1 - 8
111 PLAY	Start playing the recorded sound	–
112 STOP	Stop recording / playing	–
113 CLEAR	Erase all recorded audio	–
114 VOICE GUIDE	The frequency of the operating band will be announced.	–
115 USB CAMERA (Requires optional Microphone with Snapshot Camera MH-85A11U)		
SIZE	Picture size setting.	160×120 / 320×240
QUALITY	Picture quality setting.	LOW / NORMAL / HIGH

Menu Number / Item	Description	Selectable options (Options in bold are the default settings)
→ CLONE		
116 This → Other	Send all settings to other FTM-200D	–
117 Other → This	Receive all settings from other FTM-200D	–
↺ RESET		
118 CALLSIGN	My call sign setting. (10 characters)	*****
119 MEMORY CH RESET	Erase registered memory channels.	–
120 APRS RESET	Return APRS settings to default.	–
121 CONFIG SET	Save configuration.	–
122 CONFIG RECALL	Recall configuration.	–
123 SOFTWARE VERSION	Display the software version.	Main Ver. / Sub Ver. / DSP Ver.
124 FACTORY RESET	Return all settings to factory default.	–

Restoring to Defaults (Reset)

Caution

When the All Reset function is performed, all data registered in the memory will be deleted. Be sure to note the settings on paper or back up the data on a microSD memory card.

All Reset

To restore all transceiver settings and memory content to the factory defaults.

1. Press and hold the [**F MENU**] key.
The Setup Menu screen will be displayed.
2. Press the **DIAL** knob to select [**124 FACTORY RESET**],
then press the **DIAL** knob.
“**FACTORY RESET**” appears on the LCD.



RESET	
121	CONFIG SET
122	CONFIG RECALL
123	SOFTWARE VERSION >
124	FACTORY RESET
	>

3. Rotate the **DIAL** knob to select [**OK**].
To cancel the resetting, select [CANCEL], then press the DIAL knob.
4. Press the **DIAL** knob to reset all.
After resetting all defaults, the call sign input message appears on the LCD. Set the call sign (page page 4).

Memory Channels Reset

To erase only the registered all memory channels.

1. Press and hold the [**F MENU**] key → [**119 MEMORY CH RESET**]
“MEMORY CH RESET” appears on the LCD.
2. Rotate the **DIAL** knob to select [**OK**].
To cancel the resetting, select [CANCEL], then press the DIAL knob.
3. Press the **DIAL** knob to delete all memory contents.

APRS Reset

To restore all APRS settings to the factory defaults.

1. Press and hold the [**F MENU**] key → [**120 APRS RESET**]
“APRS RESET” appears on the LCD.
2. Rotate the **DIAL** knob to select [**OK**].
To cancel the resetting, select [CANCEL], then press the **DIAL** knob.
3. Press the **DIAL** knob to delete all APRS settings.

Text input screen

The keyboard screen is displayed when entering the station call sign or memory channel tag.

● Character input method

1. Rotate the **DIAL** knob to select a character, then press the **DIAL** knob.

- enter the selected character
- Repeat step 1 to enter additional characters.

When input is complete, press and hold the **DIAL** knob to save the characters and return to normal operation.



Delete characters and operate the cursor

- / : Move the cursor to left/right in the text input area.
- : Erase the character at the left of the cursor position.
- : Enter a space at the cursor position.

● Alphabet Input

- Rotate the **DIAL** knob to select [] or [], and each time the **DIAL** knob is pressed, the input screen changes as follows:
- Rotate the **DIAL** knob to select [], and each time the **DIAL** knob is pressed, the input switches between small and capital letters.

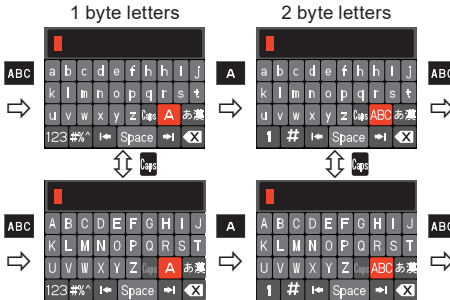

● AlphaNumbers and Symbols Input

- Rotate the **DIAL** knob to select [], [], [] or [] and each time the **DIAL** knob is pressed, the input screen changes as follows:

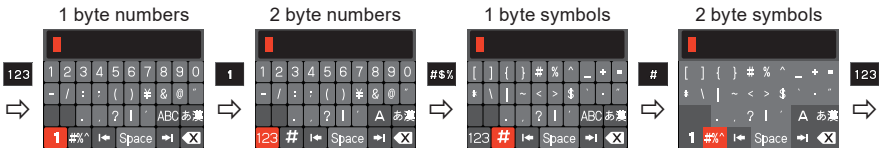

● General

Frequency Range	: TX 144 - 148MHz or 144 - 146MHz 430 - 450MHz or 430 - 440MHz (Depends on the transceiver version)
	: RX 108 - 137MHz (AIR Band) 137 - 174MHz (144MHz HAM / VHF Band) 174 - 400MHz (GEN) 400 - 480MHz (430MHz HAM / UHF Band) 480 - 999.99MHz (GEN) (USA Cellular Blocked)
Channel Steps	: 5 / 6.25 / 8.33 / 10 / 12.5 / 15 / 20 / 25 / 50 / 100kHz (8.33kHz: only for Air band)
Mode of Emission	: F1D, F2D, F3E, F7W
Frequency Stability	: $\pm 2.5\text{ppm}$ (-4°F to $+140^{\circ}\text{F}$ [-20°C to $+60^{\circ}\text{C}$])
Antenna Impedance	: 50Ω
Supply Voltage	: Nominal 13.8V DC, negative ground
Current Consumption (approx.)	: 0.5 A (Receive) 11 A (50W TX, 144MHz) 11 A (50W TX, 430MHz)
Operating Temperature Range	: -4°F to $+140^{\circ}\text{F}$ [-20°C to $+60^{\circ}\text{C}$]
Case Size (W x H x D)	: Radio unit 5.47" x 1.66" x 5.2" (139 x 42 x 132 mm) (w/o Fan) Controller 5.47" x 2.09" x 0.7" (139 x 53 x 18mm) (w/o Knob)
Weight (approx.)	: 2.43lbs (1.1kg) (with Radio Unit, Controller, Control Cable)

● Transmitter

RF Power Output	: 50W / 25W / 5W
Modulation Type	: F1D, F2D, F3E: Variable Reactance Modulation F7W: 4FSK(C4FM)
Maximum Deviation	: $\pm 5\text{kHz}$
Spurious Emission	: At least 60dB below
Microphone Impedance:	2k Ω
DATA Jack Impedance	: 10k Ω

● Receiver

Circuit Type	: Double-Conversion Super heterodyne
Intermediate Frequency	: 1st: 58.05MHz, 2nd: 450kHz
Sensitivity	: 0.8 μ V TYP for 10dB SN (108 - 137MHz, @AM) 0.2 μ V for 12dB SINAD (137 - 140MHz, @FM) 0.2 μ V for 12dB SINAD (140 - 150MHz, @FM) 0.25 μ V for 12dB SINAD (150 - 174MHz, @FM) 0.3 μ V TYP for 12dB SINAD (174 - 222MHz, @FM) 0.25 μ V TYP for 12dB SINAD (222 - 300MHz, @FM) 0.8 μ V TYP for 10dB SINAD (300 - 336MHz, @AM) 0.25 μ V for 12dB SINAD (336 - 420MHz, @FM) 0.2 μ V for 12dB SINAD (420 - 470MHz, @FM) 0.2 μ V for 12dB SINAD (470 - 540MHz, @FM) 0.8 μ V for 12dB SINAD (540 - 800MHz, @FM) 0.4 μ V TYP for 12dB SINAD (800 - 900MHz, @FM) 0.8 μ V TYP for 12dB SINAD (900 - 999.99MHz, @FM) 0.19 μ V TYP for BER 1% (Digital Mode) Cellular Blocked (USA only)
AF Output	: 3W (8 Ω , THD10%, 13.8V) Internal Speaker 3W (8 Ω , THD10%, 13.8V) External Speaker
AF Output Impedance	: 8 Ω
Strength of secondary radio waves	: 4 nW and below

● Bluetooth (Optional BU-4)

Version	: Version 4.2
Class	: Class 2
Output Power	: 2dBm

Specifications are subject to change without notice, and are guaranteed within the 144/430MHz amateur bands only.

The Bluetooth® wordmark and logo are registered trademarks owned by Bluetooth SIG, Inc. and are used under license by Yaesu Musen Co., Ltd.

About internal spurious signals

The internal oscillator frequency relationship below may cause some effect on the receiver mixer and IF circuits. However, this is not a malfunction (refer to the calculation formulas below: n is any integer).

- IReception frequency = 16MHz x n times
- IReception frequency = 12MHz x n times
- IReception frequency = 57.6MHz x n times
- IReception frequency = 44MHz x n times
- IReception frequency = 19.2MHz x n times

YAESU

The radio

Copyright 2022
YAESU MUSEN CO., LTD.
All rights reserved.

No portion of this manual may be
reproduced without the permission of
YAESU MUSEN CO., LTD.

YAESU MUSEN CO., LTD.

Tennozu Parkside Building
2-5-8 Higashi-Shinagawa, Shinagawa-ku, Tokyo 140-0002 Japan

YAESU USA

6125 Phyllis Drive, Cypress, CA 90630, U.S.A.

YAESU UK

Unit 12, Sun Valley Business Park, Winnall Close
Winchester, Hampshire, SO23 0LB, U.K.

2202D-AS-1
Printed in Japan



E H O 6 1 M 2 0 0