

YAESU

The radio

VHF/UHF

**ULTRA-COMPACT DUAL-BAND TRANSCEIVER
WITH WIDE BAND COVERAGE**

VX-3RIE

OPERATING MANUAL



YAESU MUSEN CO., LTD.

Tennozu Parkside Building
2-5-8 Higashi-Shinagawa, Shinagawa-ku, Tokyo 140-0002 Japan

YAESU USA

6125 Phyllis Drive, Cypress, CA 90630, U.S.A.

YAESU UK

Unit 12, Sun Valley Business Park, Winnall Close
Winchester, Hampshire, SO23 0LB, U.K.

Contents

General Description	1	Scanning	54
Controls & Connections	2	Setting the Scan-Resume Mode	54
Keypad Functions	3	VFO Scanning	56
LCD Display	4	How to Skip (Omit) a Frequency during VFO Scan	57
Accessories & Options	5	Setting the Squelch Level during active Scanning Operation	57
Installation of Accessories	6	Memory Scanning	58
Antenna Installation	6	How to Skip (Omit) a Channel during Memory Scan Operation	59
Installation of FNB-82LI Battery Pack	6	Preferential Memory Scan	60
Battery Charging	7	Memory Bank Scan	61
Installation of FBA-37 Alkaline Battery Case	8	Programmable (Band Limit) Memory Scan (PMS)	62
Battery Life Information	8	Priority Channel Scanning (Dual Watch)	63
Interface of Packet TNCs	9	Priority Revert Mode	64
Operation	10	Automatic Lamp Illumination on Scan Stop	65
Switching Power On and Off	10	Band Edge Beeper	65
Adjusting the Volume Level	10	Smart Search Operation	66
Squelch Adjustment	11	Setting the Smart Search Mode	66
Selecting the Operating Band	12	Storing Smart Search Memories	67
Frequency Navigation	13	Channel Counter Operation	68
Transmission	14	Setting the Channel Counter Sweep Width	69
AM and FM Broadcast Reception	15	Message Feature	70
SUB-RX Operation	16	Programming a Message	70
Advanced Operation	18	Programming a Member List	71
Keyboard Locking	18	Set Your Personal ID	72
Adjusting the Keypad Beeper Volume Level	19	Sending a Messages	72
Keypad/LCD Illumination	20	Receiving a Message	73
Checking the Battery Voltage	20	Emergency Feature	74
Changing the Channel Steps	21	Emergency Channel Operation	74
Changing the Receiving Mode	21	Emergency Automatic ID (EAI) Feature	75
S-meter Squelch	22	Selecting the EAI mode and its Transmit Time	76
Checking the Temperature	23	Activating the EAI feature To Locate an Unresponsive Operator Using the EAI feature	77
Repeater Operation	24	ARTS™ (Automatic Range Transponder System)	78
Repeater Shifts	24	Basic ARTS Setup and Operation	79
Automatic Repeater Shift (ARS)	24	ARTS Polling Time Options	79
Manual Repeater Shift Activation	25	ARTS Alert Beep Options	80
Changing the Default Repeater Shifts	25	CW Identifier Setup	81
Tone Calling (1750 Hz)	26	Internet Connection Feature	82
Checking the Repeater Uplink (Input) Frequency	26	SRG ("Sister Radio Group") mode	82
CTCSS/DCS/EPCS Operation	28	FRG ("Friendly Radio Group") mode	83
CTCSS Operation	28	Programming the FRG code	83
DCS Operation	30	Operation (Accessing an FRG Node)	84
DCS Code Inversion	31	DTMF Operation	85
Tone Search Scanning	32	Manual DTMF Tone Generation	85
EPCS (Enhanced Paging & Code Squelch)	34	DTMF Autodialer	85
Storing the CTCSS Tone Pairs for EPCS Operation	34	CW Learning Feature	88
Activating the Enhanced Paging & Code Squelch System	35	CW Training Feature	90
Paging Answer Back	36	Miscellaneous Setting	91
CTCSS/DCS/EPCS Bell Operation	37	Password	91
Programming the User Beep	38	Programming the [F] Key	92
Split Tone Operation	39	Assign the Set Mode Item to the [F] Key	92
Memory Mode	41	ATT (Front End Attenuator)	93
Regular Memory Channel Operation	42	Receive Battery Saver Setup	93
Memory Storage	42	WakeUp Feature	94
Storing Independent Transmit Frequencies ("Odd Split")	43	TX Battery Saver	95
Memory Recall	43	Disabling the BUSY Indicator	95
HOME Channel Memory	44	Automatic Power-Off (APO) Feature	96
Home Channel Recall	44	Transmitter Time-Out Timer (TOT)	97
Home Channel Frequency Change	44	Automatic Power-On Feature	98
Labeling Memories	45	Busy Channel Lock-Out (BCLO)	98
Memory Offset Tuning	46	Changing the TX Deviation Level	99
Masking Memories	47	Changing the Microphone Gain	99
Memory Bank Operation	48	My Bands Operation	100
Assigning Memories to a Memory Bank	48	Changing the Status of the [VOL] Key	101
Memory Bank Recall	48	Cloning	102
Removing Memories from a Memory Bank	49	Set (Menu) Mode	103
Changing a Memory Bank's Name	49	Reset Procedures	125
Moving Memory Data to the VFO	50	Specifications	126
Memory Only Mode	50	FCC Notice	128
Special Memory Channel Operation	51		
Weather Broadcast Channels	51		
VHF Marine Channels	52		
Short-wave Broadcast Station Memory Channels	53		

GENERAL DESCRIPTION

The **VX-3R/E** is a micro-miniature multiband FM transceiver with extensive receive frequency coverage, providing local-area two-way amateur communications along with unmatched monitoring capability.

The **VX-3R/E**'s incredibly small size allows you to take it anywhere - hiking, skiing, or while walking around town - and its operating flexibility brings the user many avenues of operating enjoyment. Its incredibly tiny **FNB-82LI** Lithium-Ion Battery Pack provides up to 1.5 Watts of transmit power on VHF, and 1 Watt on UHF. In addition to the 144- and 430-MHz transceiver operation, the **VX-3R/E** provides receive coverage of the AM (MF) broadcast band, with the internal bar antenna, the FM broadcast bands, HF Shortwave Bands, VHF and UHF TV bands, the VHF AM aircraft band, and a wide range of commercial and public safety frequencies! The **VX-3R/E** internal antenna bar provides good AM broadcast receive capabilities without having to use an external antenna.

Additional features include an Enhanced Paging and Code Squelch (EPCS), which allows you to page a particular station and only receive calls from that station. A security Password may be set, which will allow you to turn on and operate your transceiver only after you enter your Password. A convenient key provides access to Vertex Standard's WIREST™ (Wide-Coverage Internet Repeater Enhancement System). The Emergency Automatic ID (EAI) function can automatically cause your **VX-3R/E** to transmit your callsign and engage your rig's microphone, even if you are disabled and unable to press the PTT switch. Features include: transmit Time-Out Timer (TOT), Automatic Power-Off (APO), and Automatic Repeater Shift (ARS). Yaesu's exclusive ARTS™ (Auto-Range Transponder System) which "beeps" the user when you move out of communications range with another ARTS™ equipped station. There is provision to reduce the TX deviation for use in areas of high channel congestion. The squelch circuit allows adjusting the squelch to open at a programmable setting of the S-Meter, thus reducing guesswork in setting the squelch threshold.

We appreciate your purchase of the **VX-3R/E**, and encourage you to read this manual thoroughly, and learn about the many exciting features of your thrilling new Yaesu hand-held transceiver!

CONTROL & CONNECTIONS

ANTENNA Jack

Connect the supplied rubber flex antenna (or another antenna presenting a 50-Ohm impedance) here.

MIC/SP Jack

This four-conductor miniature jack provides connection points for microphone audio, earphone audio, PTT, and ground.

DIAL Knob

The main tuning Dial is used for setting the operating frequency, and is used for audio volume level, menu selections, and other adjustments. To rotate this Dial knob, pull the knob to unlock the mechanical dial lock, and then rotate the Dial knob.

PTT Switch

Press this switch to transmit, and release it to receive, after your transmission is completed.

TX/BUSY Indicator

This indicator glows green when the squelch opens, and turns red during transmit. During "Emergency" operation (see page 74), this indicator will glow (or flash) white.

MONI/T.CALL Switch

USA/EXP version:
Pressing this key disables the noise squelching action, allowing you to hear very weak signals near the background noise level.

Europe version:
Pressing this key activates the T-CALL (1750 Hz) for repeater access.

EAR Jack

This 3-pin miniature jack provides connection points for stereo earphones.

This 3-pin miniature jack allows connection to stereo earphones. When using after-market stereo earphones with this jack, you may enjoy the FM broadcast band in stereo.

POWER Switch

Press and hold this switch in for one second to toggle the transceiver's power on and off.

EXT DC Jack

This coaxial DC jack allows connection to an external DC power source (3.7 - 7.0V DC). The center pin of this jack is the Positive (+) connection.

KEYPAD

These nine keys select many of most important operating features on the VX-3E. The functions of the keys are described in detail on the pages to follow.

MIC

The internal microphone is located here.





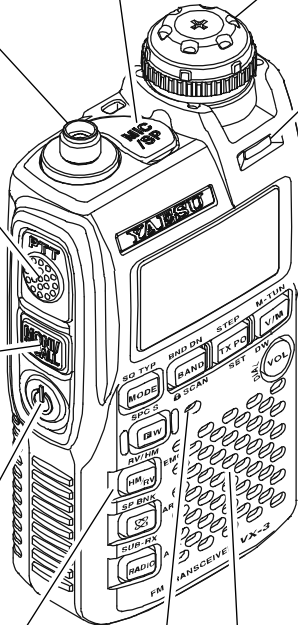



SPEAKER

The internal speaker is located here.



CONTROL & CONNECTIONS

KEYPAD FUNCTIONS

KEY	PRIMARY FUNCTION (PRESS KEY)	SECONDARY FUNCTION (PRESS [F/W] + KEY)	THIRD FUNCTION (PRESS AND HOLD KEY)
	Switches the operating mode.	Activates CTCSS or DCS operation.	Activates the Smart Search™ and Channel Counter features.
	Moves operation to the next-highest frequency band. Activates the “Memory Bank” feature while in the Memory Recall mode.	Moves operation to the next-lowest frequency band. Holding this key after pressing the [F/W] key activate the key lockout feature.	Activates the Scanner Upward (toward a higher frequency or a higher channel number).
	Switches the transmit power output between “HI” and “LOW”.	Selects the synthesizer steps to be used during VFO operation.	Enters the Set (Menu) Mode.
	Switches frequency control between the VFO and Memory Systems.	Activates the “Memory Tune” function while in the Memory Recall mode.	Activates the Dual Watch feature.
	Activates the “Alternate” key function.	Disables the “Alternate” key function.	Activates the “Memory Write” mode (for memory channel storage).
	Reverses transmit and receive frequencies while working through a repeater.	Switches operation to the “Home” (favorite frequency) channel.	Activates the Emergency Channel Operation. See page 74.
	Activates the WIRES™ (Internet Connection) feature.	Recalls the “Weather Broadcast” channels and Short-wave broadcast station channels.	Activates the ARTS™ feature.
	Enter the Broadcast Reception mode. While in the Broadcast Reception mode, press the [BAND] key to toggle the receiving band between “AM” broadcast band and “FM” broadcast band.	Enables the antenna selection to be used.	Activates the SUB-RX Operation. See page 16.
	N.A.	Toggle the DIAL knob function between the “Frequency Control” and “Receiver Audio Control”.	Rotate the DIAL knob while holding the [VOL] key to adjust the audio volume level.

CONTROL & CONNECTIONS

LCD DISPLAY

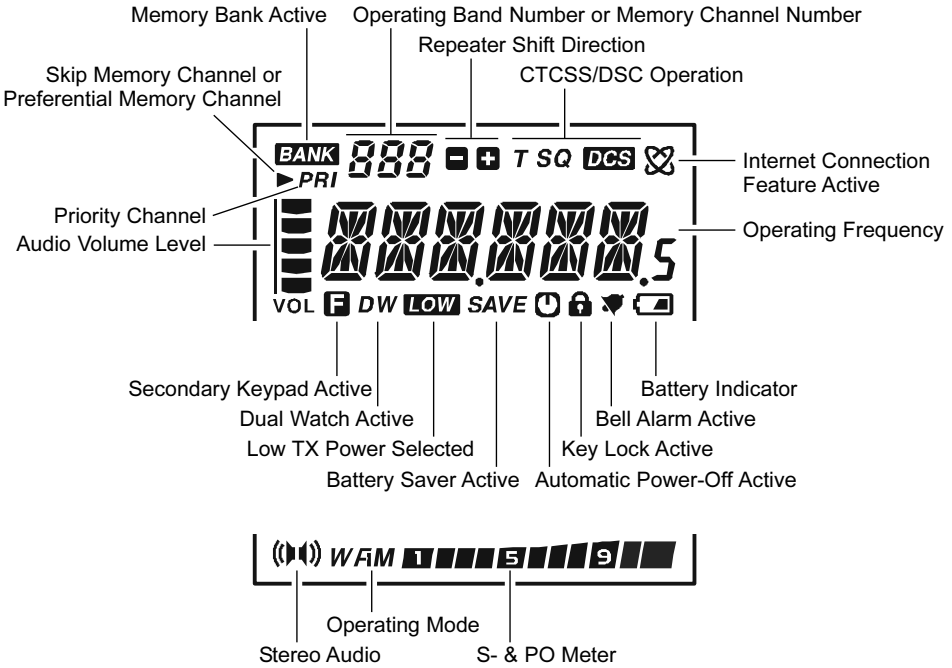

ACCESSORIES & OPTIONS

SUPPLIED ACCESSORIES

FNB-82LI	3.7 V, 1100 mAh Rechargeable Lithium Ion Battery Pack	1
PA-46B, C, U*	2.5-Hour Charger	1
YHA-66	Antenna	1
Operating Manual		1
Warranty Card		1

AVAILABLE OPTIONS

① CSC-92	Soft Case
② CN-3	BNC-to-SMA Adapter
③ SSM-63A	VOX Headset
④ MH-34B4B	Speaker/Microphone
⑤ SSM-57A	Earpiece/Microphone
⑥ CT-27	Cloning Cable
⑦ CT-44	Microphone Adapter
⑧ FBA-37	Dry Cell Battery Case for 3 x “AA” Alkaline Cells
⑨ FNB-82LI	3.7 V, 1100 mAh Rechargeable Lithium Ion Battery Pack
⑩ E-DC-21	DC Cable w/ Cigarette-Lighter Adapter
⑪ PA-46B, C, U*	2.5-Hour Charger

※: “**B**” suffix is for use with 100-120 VAC, “**C**” suffix is for use with 230-240 VAC, and “**U**” suffix is for use with 230 VAC.

Availability of accessories may vary. Some accessories are supplied as standard per local requirements, while others may be unavailable in some regions. Consult your Yaesu dealer for details regarding these and any newly available options. Connection of any non-Yaesu-approved accessory, should it cause damage, may void the Limited Warranty on this apparatus.

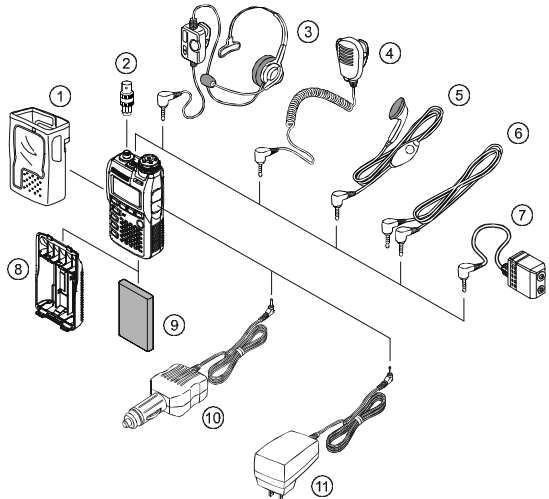

INSTALLATION OF ACCESSORIES

ANTENNA INSTALLATION

The supplied antenna provides good results over the entire frequency range of the transceiver. However, for enhanced base station medium-wave and shortwave reception, you may wish to connect an external (outside) antenna, as the supplied antenna is very small and cannot be expected to provide high performance at these frequencies.

To install the supplied antenna, hold the bottom end of the antenna and screw it onto the mating connector on the transceiver until it is snug. Do not over-tighten by use of extreme force.

Notes:

- Never transmit without having an antenna connected.
- When installing the supplied antenna, never hold the *upper* part of the antenna while screwing it onto the mating connector on the transceiver.
- If using an external antenna for transmission, ensure that the SWR presented to the transceiver is 1.5:1 or lower, to avoid excessive feedline loss.

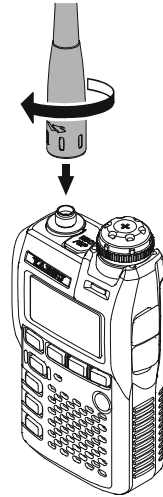

INSTALLATION OF FNB-82LI BATTERY PACK

The **FNB-82LI** is a high-performance Lithium-Ion battery providing high capacity in a *very* compact package. Under normal use, the **FNB-82LI** may be used for approximately 300 charge cycles, after which operating time may be expected to decrease. If you have an older battery that is displaying diminished capacity, you should replace the pack with a new one. Installation of the battery is easy and quick:

1. Slide the Battery Cover Latch to the Unlock position and then slide the Battery Cover toward the bottom to remove it.
2. Install the **FNB-82LI** into the Battery Compartment.
3. Replace the Battery Cover and then slide the Battery Cover Latch into the "Lock" position.

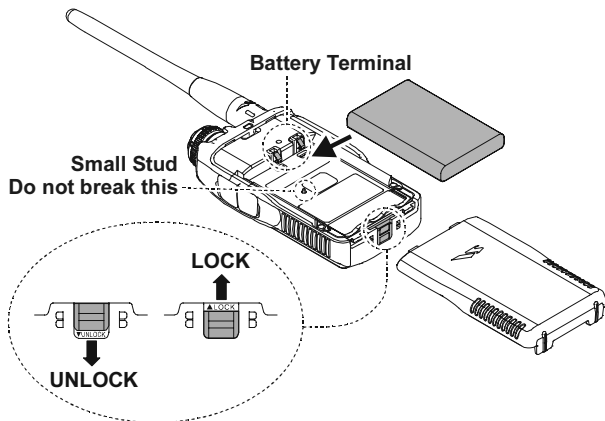

Important Note: *There is a small stud in the Battery Compartment of the VX-3R/E. This stud is a switch for the battery detection. Please be careful not to break this stud while changing the battery.*

INSTALLATION OF ACCESSORIES

BATTERY CHARGING

If the battery has never been used, or its charge is depleted, it may be charged by connecting the **PA-46** Battery Charger, as shown in the illustration, to the **EXT DC** jack. If only 12 ~ 16 Volt DC power is available, the optional **E-DC-21** DC Adapter (with its cigarette lighter plug) may also be used for charging the battery.

While the battery is being charged, the display will indicate “CHGNG” and the **TX/BUSY** indicator will glow red. The S-meter will deflect according to the charging status.

When charging is finished, the display will change to indicate “CHGFUL” and the **TX/BUSY** indicator will glow green.

The **PA-46** is only designed for the charging of the **VX-3R/E**'s battery, and is not suitable for other purposes. Please be advised that the **PA-46** may contribute noise to TV and radio reception in the immediate vicinity, so we do not recommend its use adjacent to such devices.

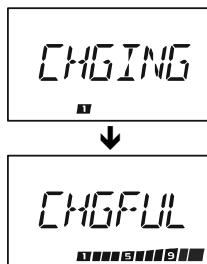
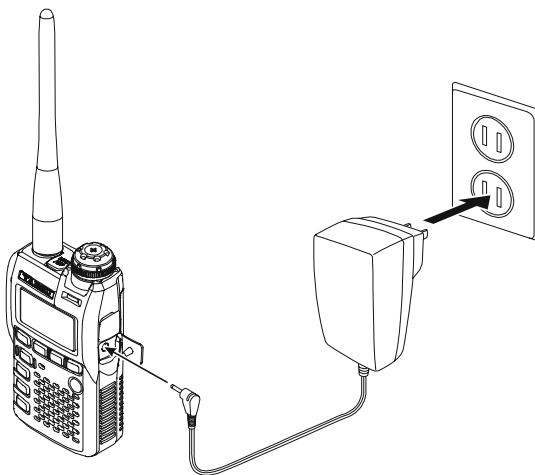

Warning:

- 1) *Perform the battery charging where the ambient temperature range is +41 °F to +95 °F (+5 °C to +35 °C). Charge out of this range could cause damage to the battery pack.*
- 2) *If the charge is not completed in three hours or if “CHGERR” appears in the display, the battery may be deteriorated. Do not attempt to forcibly charge the battery, Please contact your Yaesu dealer.*
- 3) *If you do not use the VX-3R/E for a long time, remove the FNB-82LI Lithium-Ion battery pack from the VX-3R/E, as battery leakage could cause damage to the VX-3R/E and FNB-82LI.*
- 4) *When an FNB-82LI Lithium-Ion battery pack is not used for a long time, please remove it from the transceiver. Also, while in storage, the charge will drain slightly over time and the battery should be recharged 50 % each six months.*

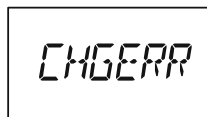

INSTALLATION OF ACCESSORIES

INSTALLATION OF FBA-37 ALKALINE BATTERY CASE (OPTION)

The optional **FBA-37** Battery Case allows operation of the **VX-3R/E** using three “AA” size alkaline batteries.

When installing batteries, insert the (–) end first, then press in the (+) end so the battery snaps into place. Always replace all three batteries at the same time, paying attention to the polarity indicated inside the case.

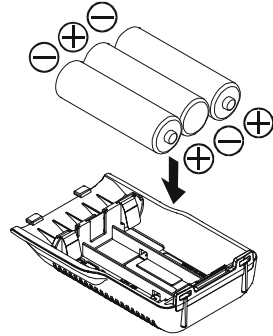

The **FBA-37** must not be used with rechargeable cells. The **FBA-37** does not contain the thermal and over-current protection circuits (provided in the **FNB-82LI** Lithium-Ion Battery Pack) required when utilizing Ni-Cd and Ni-MH cells.





Important Note:

- 1) *The FBA-37 is designed for use only with AA-type Alkaline cells.*
- 2) *If you do not use the VX-3R/E for a long time, remove the alkaline batteries from the FBA-37, as battery leakage could cause damage to the VX-3R/E and FBA-37.*
- 3) *Never connect the external DC power supply to the VX-3R/E, when the FBA-37 Battery Pack is installed in the VX-3R/E.*

BATTERY LIFE INFORMATION

When the battery charge is almost depleted, a “” icon will appear on the display. When the “” icon appears, it is recommended that you charge the battery soon.



OPERATING BAND	BATTERY LIFE (APPROX.)		BATTERY INDICATOR
	FNB-82LI	FBA-37	
144 MHz*1	6.0 hours	7.0 hours	No Icon: Enough Battery Power  : Lower Battery Power  (Blinking): Prepare to charge (or replace) the Battery
430 MHz*1	6.5 hours	7.5 hours	
AM/FM Broadcast Band*2	20.0 hours	25.0 hours	

*1: TX: 6 seconds, RX: 6 seconds, and Squelched: 48 seconds.

*2: Continuous signal reception.

The current battery voltage can be displayed manually on the display, via the Set Mode Item 23: DC VLT.

Battery capacity may be reduced during extremely cold weather operation. Keeping the radio inside your parka may help preserve the full charge capacity.

INTERFACE OF PACKET TNCs

The **VX-3R/E** may be used for Packet operation using the optional **CT-44** microphone adapter (available from your Yaesu dealer) for easy interconnection to commonly-available connectors wired to your TNC. You may also build your own cable, using a four-conductor miniature phone plug, per the diagram below.

The audio level from the receiver to the TNC may be adjusted by the transceiver's volume control, as with voice operation (Rotate the **DIAL** knob while pressing and holding the [**VOL**] key, do not forget to pull the **DIAL** knob to rotate the **DIAL** knob). The input level to the **VX-3R/E** from the TNC should be adjusted at the TNC side. The optimum input audio voltage is approximately 5 mV at 2000 Ohms.

Be sure to turn the transceiver and TNC off before connecting the cables, to prevent voltage spikes from possibly damaging your transceiver.

When you are operating in Packet Mode, switch the Receive Battery Saver OFF, as the "sleep" cycle may "collide" with the beginning of an incoming Packet transmission, causing your TNC not to receive the full data burst. See page 93 for details regarding Battery Saver setup.

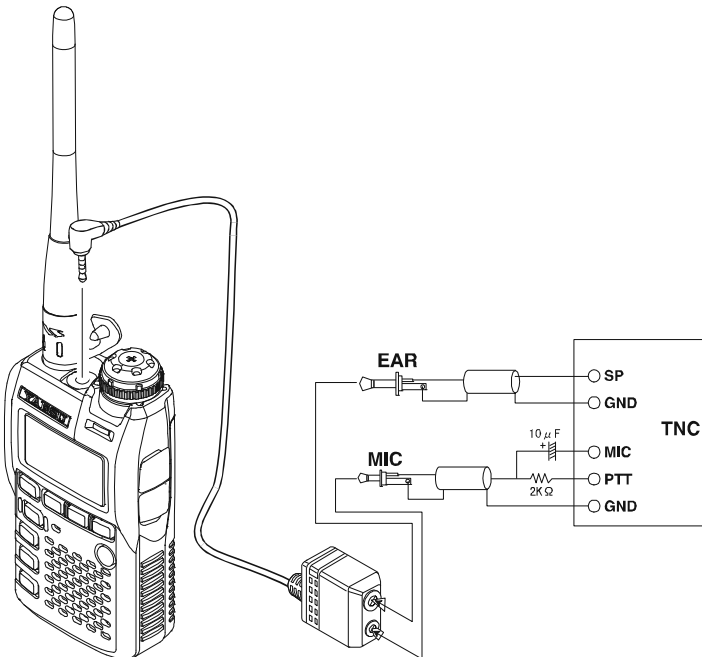

OPERATION



Hi! I'm R. F. Radio, and I'll be helping you along as you learn the many features of the VX-3R/E. I know you're anxious to get on the air, but I encourage you to read the "Operation" section of this manual as thoroughly as possible, so you'll get the most out of this fantastic new transceiver. Now...let's get operating!

SWITCHING POWER ON AND OFF

1. Be sure the Battery Pack is installed, and that the battery is fully charged. Connect the antenna to the top panel **ANTENNA** jack.
2. Press and hold in the orange **POWER** switch (on the left side of the transceiver) for one second. Two beeps will be heard when the switch has been held long enough, and the current DC supply voltage will appear on the display for 2 seconds. If you are using the **FNB-82LI** Battery Pack, the small "Lit" icon at the top of the display confirms that the Lithium-Ion Battery Pack has been detected. After this 2-second interval, the display will resume its normal indication of the operating frequency.
3. To turn the **VX-3R/E** off, press and hold in the orange **POWER** switch again for one second.

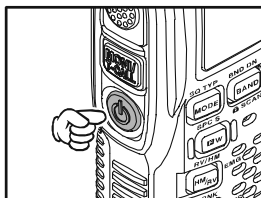

1) If you don't hear the two "Beep" tones when the radio comes on, the Beeper may have been disabled via the Set Mode Item 14: BP SEL. See page 19, which tells you how to reactivate the Beeper.

2) You can change the Opening Message (DC supply voltage indication) to any desired message (up to 6 characters) via Set Mode Item 59: OPN.MSG; see page 115 for details.

ADJUSTING THE VOLUME LEVEL

Pull the **DIAL** knob to unlock the mechanical dial lock, then rotate the **DIAL** knob while pressing and holding the **[VOL]** key to set the desired audio level. Clockwise rotation increases the volume level.

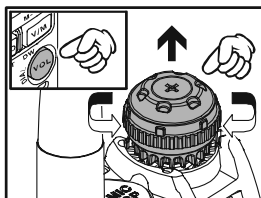

1) You may set the Audio Output Level to the Speaker, and the Earphone Output Level individually. The "SP" notation (which means Speaker) appears in the Memory Channel Number display slot while adjusting the Speaker Output Level. The "HP" notation (which means Headphone) appears in the Memory Channel Number display slot while adjusting the Earphone Output Level.

*2) When pressing the **[F/W]** key followed by the **[VOL]** key, the **DIAL** knob function changes to the Volume Level selection instead of the frequency control. In this case, the "VOL" notation on the display blinks. Pressing the **[F/W]** key followed by the **[VOL]** key again, the **DIAL** knob function returns to the frequency control. Furthermore, you may change the **[VOL]** key function via Set Mode Item 92: VOL MD. See page 101 for details.*

SQUELCH ADJUSTMENT

The **VX-3R/E**'s Squelch system allows you to mute the background noise when no signal is being received. The Squelch system make "standby" operation more pleasant, and significantly reduces battery current consumption.

The Squelch system may be adjusted independently for the FM and Wide-FM (FM Broadcast) modes.

1. Press and hold in the **[TXPO]** key for one second to enter the Set mode.

2. Rotate the **DIAL** knob to select Set Mode Item 78: SQ LVL.

Note: Do not forget to pull the **DIAL** knob to rotate the **DIAL** knob.

3. Press the **[TXPO]** key momentarily to enable adjustment of this Item.

4. Rotate the **DIAL** knob to set the Squelch so that the background noise is just silenced (typically at a setting of about "1" or "2" for AM/FM, and "2" or "3" for Wide-FM/FM Broadcast/AM Broadcast). This is the point of maximum sensitivity to weak signals.

Note: Do not forget to pull the **DIAL** knob to rotate the **DIAL** knob.

5. When you are satisfied with the Squelch threshold setting, press the **PTT** switch momentarily to save the new setting and exit to normal operation.

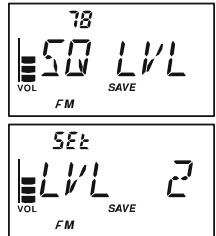

1) The **VX-3R/E** can set the squelch threshold level on the AM mode, FM mode, Wide FM mode, and AM Broadcast individually.

2) A special "S-meter Squelch" feature is provided on the **VX-3R/E**. This feature allows you to set the squelch so that only signals exceeding a certain S-meter level will open the squelch. See page 22 for details.

3) If you're operating in an area of high RF pollution, you may need to consider "Tone Squelch" operation using the built-in CTCSS Decoder. This feature will keep your radio quiet until a call is received from a station sending a carrier, which contains a matching (subaudible) CTCSS tone. Or, if your friends have radios equipped with DCS (Digital Coded Squelch) like your **VX-3R/E** has, try using that mode for silent monitoring of busy channels.

SELECTING THE OPERATING BAND

The **VX-3R/E** covers an incredibly wide frequency range, over which a number of different operating modes are used. Therefore, the **VX-3R/E**'s frequency coverage has been divided into different operating bands, each of which has its own pre-set channel steps and operating modes. You can change the channel steps and operating modes later, if you like (see page 21).

OPERATING BAND [BAND NUMBER]	FREQUENCY RANGE	
	USA VERSION	EXP/EU VERSION
SW Band [1]	1.8 - 30 MHz	1.8 - 30 MHz
50 MHz Ham Band [2]	30 - 76 MHz	30 - 76 MHz
Air Band [3]	108 - 137 MHz	108 - 137 MHz
144 MHz Ham Band [4]	137 - 174 MHz	137 - 174 MHz
VHF-TV Band [5]	174 - 222 MHz	174 - 222 MHz
Information Band 1 [6]	222 - 420 MHz	222 - 420 MHz
430 MHz Ham Band [7]	420 - 470 MHz	420 - 470 MHz
UHF-TV Band [8]	470 - 774 MHz	470 - 800 MHz
Information Band 2 [9]	803 - 999 MHz	803 - 999 MHz

To Change Operating Bands:

1. Press the **[BAND]** key repetitively. You will see the LCD indication move toward a higher frequency band each time you press the **[BAND]** key.

Indicates a Band Number according to the receiving frequency in the Memory Channel Number Display Slot of the display.

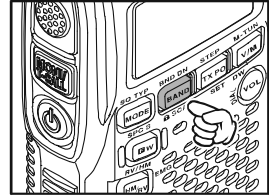

2. If you wish to move the operating band selection downward (toward lower frequencies), press the **[F/W]** key first, then press the **[BAND]** key.
3. Once you have selected the desired band, you may initiate manual tuning (or scanning) per the discussion in the next chapter.



1) The **VX-3R/E** has an **AM / FM broadcast radio**. You can receive these bands independently. See page 15 for details.

2) If desired, you may omit (skip) one or more bands from the band selection loop for faster recall of your favorite operating bands. See page 100 for details.

FREQUENCY NAVIGATION

The **VX-3R/E** will initially be operating in the “VFO” mode. This is a channelized system which allows free tuning throughout the currently-selected operating band.

Two basic frequency navigation methods are available on the **VX-3R/E**:

1) TUNING DIAL

Rotation of the **DIAL** knob allows tuning in the pre-programmed steps established for the current operating band. Clockwise rotation of the **DIAL** knob causes the **VX-3R/E** to be tuned toward a higher frequency, while counter-clockwise rotation will lower the operating frequency.

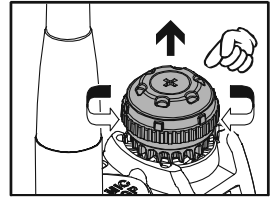

If you press the **[F/W]** key momentarily, then rotate the **DIAL** knob, frequency steps of 1 MHz will be selected. This feature is extremely useful for making rapid frequency excursions over the wide tuning range of the **VX-3R/E**.

Note: Do not forget to pull the **DIAL** knob to rotate the **DIAL** knob.

2) SCANNING

From the VFO mode, press and hold in the **[BAND]** key for one second, and *while still holding in the [BAND] key*, rotate the **DIAL** knob to select the bandwidth for the VFO scanner. Release the **[BAND]** key to begin scanning toward a higher frequency. The scanner will stop when it receives a signal strong enough to break through the Squelch threshold. The **VX-3R/E** will then hold on that frequency according to the setting of the “RESUME” mode (Set Mode Item 75: SCN.RSM). See page 54 for more details regarding Scan Operation.

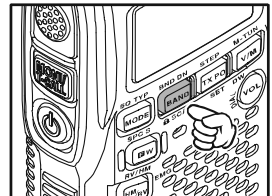

If you wish to reverse the direction of the scan (i.e. toward a lower frequency, instead of a higher frequency), just rotate the **DIAL** knob one click in the counter-clockwise direction while the **VX-3R/E** is scanning. The scanning direction will be reversed. To revert to scanning toward a higher frequency once more, rotate the **DIAL** knob one click clockwise.

Press the **PTT** switch momentarily to cancel the scanning. This only stops the scan; it does not cause transmission to occur.

Notice

The **VX-3R/E** may receive very strong signals on the Image frequency. If you experience interference that you suspect may be coming in via an “image” path, you may calculate the possible frequencies using the formulas below. This information may be used in the design of effective countermeasures such as traps, etc.

$$\square 3.579545 \text{ MHz} \times n \quad \square 11.7 \text{ MHz} \times n \quad (n \text{ is an integer: } 1, 2, 3, \dots)$$

OPERATION

TRANSMISSION

Once you have set up an appropriate frequency inside one of the 144 MHz or 430 MHz Amateur bands on which the **VX-3R/E** can transmit, you're ready to go on the air! These are the most basic steps; more advanced aspects of transmitter operation will be discussed later.

1. To transmit, press the **PTT** switch, and speak into the front panel microphone (located in the upper left-hand corner of the speaker grille) in a normal voice level. The **TX/BUSY** indicator will glow red during transmission.
2. To return to the receive mode, release the **PTT** switch.
3. During transmission, the relative power level will be indicated on the bar graph at the bottom of the LCD. Full-scale deflection confirms "High Power" operation, while deflection of two bars indicates "Low Power" operation. Additionally, the "**LOW**" icon will appear at the bottom of the display while operating on the "Low Power" setting.

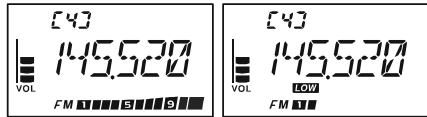
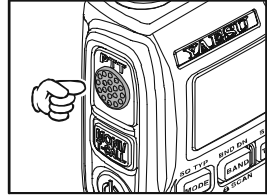

4. If you're just talking to friends in the immediate area, you'll get much longer battery life by switching to Low Power operation. To do this, press the **[TXPO]** key so that the "**LOW**" icon appears at the bottom of the display. And don't forget: always have an antenna connected when you transmit.

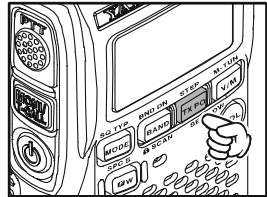

Transmission is possible only on the 144 MHz and 430 MHz bands.



1) *The VX-3R/E is smart! You can set up Low power on 144 MHz band, while leaving 430 MHz on High power, and the radio will remember the different settings on both bands. And when you store memories, you can store High and Low power settings separately in each memory, so you don't waste battery power when using very close-in repeaters!*

2) *When you are operating on the Low power setting, you can press the [F/W] key, before you press the PTT switch, to cause the VX-3R/E to transmit (temporarily) on High power. After one transmission, the power level will revert to the previously-selected (Low power) setting.*

OPERATING BAND	TRANSMIT POWER	
	FBA-37/FNB-82LI	EXT DC (6.0 V)
144 MHz	Hi: 1.5 W Low: 0.1 W	Hi: 3.0 W Low: 0.3 W
430 MHz	Hi: 1.0 W Low: 0.1 W	Hi: 2.0 W Low: 0.3 W

AM AND FM BROADCAST RECEPTION

The **VX-3R/E** includes provision for reception of AM and FM broadcasts. FM broadcast reception, utilizes a wide-bandwidth filter and stereo decoder which provides excellent fidelity.

1. Press the **[RADIO]** key momentarily to enter the Broadcast Reception mode.
2. Press the **[BAND]** key to toggle the receiving band between “AM broadcast” and “FM broadcast”.

The AM broadcast coverage is 510 to 1790 kHz and utilizes AM mode. The “**[R]**” notation (which means AM) appears in the Memory Channel Number display slot and an “**AM**” icon appears on the bottom left of the LCD.

The FM broadcast coverage is 76.00 to 107.90 MHz and utilizes Wide-FM mode. The “**[F]**” notation (which means FM) appears in the Memory Channel Number display slot and “**WFM**” icon appears on the bottom left of the LCD.

3. Rotate the **DIAL** knob to select the desired station. When receiving an FM stereo signal, “**(S)**” icon will appear at the bottom left of the display.

Note: Do not forget to pull the **DIAL** knob to rotate the **DIAL** knob.

4. Press and hold the **[RADIO]** key for one second to enable the antenna selection to be used by rotating the **DIAL** knob. Available selections are:

AM: “**BARANT**” (Uses the internal Bar Antenna) or “**BAREXT**” (Uses both the internal Bar Antenna and the Rubber Flex Antenna).

FM: “**EXTANT**” (Uses the Rubber Flex Antenna) or “**EARPHO**” (Uses the Earphone Antenna).

5. When you finish the selection, press the **[RADIO]** key momentarily to exit from the antenna selection mode.
6. Press the **[RADIO]** key momentarily again to exit from the AM and FM Broadcast Reception mode and return to normal operation.

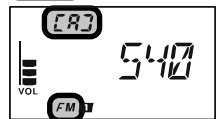
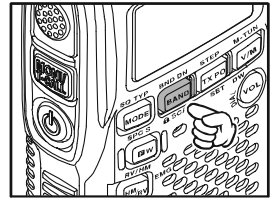
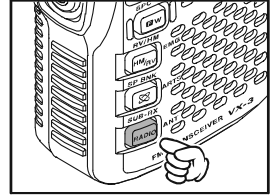

*If you wish to output the audio of the FM Broadcast station to the VX-3R/E internal speaker while using the earphone antenna, select Set Mode Item 77: **SP OUT** to “**SPKR**”.*

OPERATION

AM AND FM BROADCAST RECEPTION

SUB-RX OPERATION

The SUB-RX Operation allows you to monitor your desired amateur band frequency while receiving AM or FM broadcast stations. Furthermore, you may transmit on the amateur frequency by pressing the **PTT** switch.

When a signal is received in the amateur band, the audio is output instead of the AM or FM Broadcast station. When the amateur band signal drops, the SUB-RX Operation is resumed as determined by the user settings in the below procedures.

1. Set the **VX-3R/E** to the desired amateur band frequency by the VFO or Memory channel selection.
2. Press the **[F/W]** key then press the **[RADIO]** key.
3. Rotate the **DIAL** knob to select the resume mode of the SUB-RX Operation. Available selections are:

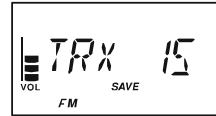

TX 1S - TX 10S: Sets the period of time after you transmit an amateur signal before the AM or FM Broadcast station will be heard from the speaker, and the SUB-RX Operation is resumed.

However, if a signal is received in the amateur band, the SUB-RX Operation will halt on the amateur band frequency and the SUB-RX Operation does not resume.

TRX 1S - TXR 10S: When the selected time passes after the amateur band signal drops or transmission is over, the AM or FM Broadcast station will be heard from the speaker and the SUB-RX Operation is resumed.

HOLD: When a signal is received in the amateur band or if you transmit on the amateur band, the SUB-RX Operation will halt on the amateur band frequency (the SUB-RX Operation does not resume.). You must manually re-initiate the SUB-RX Operation, if you wish to resume.

OFF: Disable the SUB-RX Operation.

Note: Do not forget to pull the **DIAL** knob to rotate the **DIAL** knob.

4. Press the **[RADIO]** key to exit from the resume mode selection mode of the SUB-RX Operation.
5. Press the **[RADIO]** key again to activate the SUB-RX Operation. The “**PRI**” icon appears above volume level indicator on the display.
6. Press the **[BAND]** key to toggle the receiving band between “AM broadcast” and “FM broadcast”.



AM AND FM BROADCAST RECEPTION

7. Rotate the **DIAL** knob to select the desired Broadcast station.
8. When a signal is received in the amateur band, the amateur band audio is output to the speaker. The AM or FM Broadcast station will no longer be heard. When the amateur band signal drops, the AM or FM Broadcast station will be heard from the speaker, and SUB-RX Operation is resumed (the amateur band frequency is monitored while the AM broadcast station is heard from the speaker) according to the SUB-RX Operation Resume mode selected in step 3 above.
9. You may monitor the amateur band forcibly by holding the **MONI** switch.



To disable the SUB-RX Operation, just repeat the above procedure, rotating the **DIAL** knob to select “OFF” in step 3 above.



- 1) You may transmit with the VX-3R/E on the frequency set in step 1 above by pressing the PTT switch, even if the SUB-RX Operation is activated.
- 2) If you change the [T.CALL] key to the “monitor” function via the Set Mode Item 47: M/T-CL, you may change the frequency of the amateur band by rotating the DIAL knob while pressing the [T.CALL] key.
- 3) When the [V/M] key is pressed, the VX-3R/E recalls AM and FM Broadcast station memories only. In this case, the “**BANK**” icon will blink.

ADVANCED OPERATION

Now that you're mastered the basics of **VX-3R/E** operation, let's learn more about some of the really neat features.

KEYBOARD LOCKING

In order to prevent accidental frequency change or inadvertent transmission, various aspects of the **VX-3R/E**'s keys and switches may be locked out. The possible lockout combinations are:

KEY: The front panel keys are locked out

PTT: The **PTT** switch is locked (TX not possible)

KY+PTT: Both the keys and **PTT** switch are locked out

To lock out some or all of the keys:

1. Press and hold in the [**TXPO**] key for one second to enter the Set mode.
2. Rotate the **DIAL** knob to select Set Mode Item 46: LOCK.

Note: Do not forget to pull the **DIAL** knob to rotate the **DIAL** knob.

3. Press the [**TXPO**] key momentarily to enable adjustment of this Item.
4. Rotate the **DIAL** knob to choose between one of the locking schemes as outlined above.
5. When you have made your selection, press the **PTT** switch to save the new setting and return to normal operation.



To activate the locking feature, press the [**F/W**] key, then press and hold in the [**BAND**] key for one second. The “**🔒**” icon will appear on the LCD. To cancel locking, repeat this process.



ADJUSTING THE KEYPAD BEEPER VOLUME LEVEL

A keypad beeper provides useful audible feed back whenever a keypad is pressed. The keypad beeper level changes according to the receiver audio volume level setting. However, you may adjust the volume balance between the receiving audio and keypad beeper via Set Mode Item 13: BP LVL.

1. Press and hold in the [TXPO] key for one second to enter the Set mode.
2. Rotate the **DIAL** knob to select Set Mode Item 13: BP LVL.
Note: Do not forget to pull the **DIAL** knob to rotate the **DIAL** knob.
3. Press the [TXPO] key momentarily to enable adjustment of this Item.
4. Rotate the **DIAL** knob to select the desired level.
5. When you have made your selection, press the **PTT** switch to save the new setting and return to normal operation.

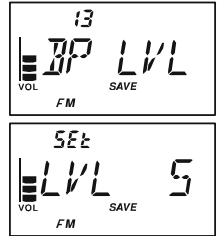

Additionally, if you want to turn the beep off:

1. Press and hold in the [TXPO] key for one second to enter the Set mode.
2. Rotate the **DIAL** knob to select Set Mode Item 14: BP SEL.
Note: Do not forget to pull the **DIAL** knob to rotate the **DIAL** knob.
3. Press the [TXPO] key momentarily to enable adjustment of this Item.
4. Rotate the **DIAL** knob to change the setting to "OFF".
5. Press the **PTT** switch to save the new setting and return to normal operation.
6. If you wish to re-enable the Beeper, just repeat the above procedure, rotating the DIAL knob to select "KEY" or "KY+SCN" in step "4" above.
KEY: The beeper sounds when you press any key.
KY+SCN: The beeper sounds when you press a key or when the scanner stops.

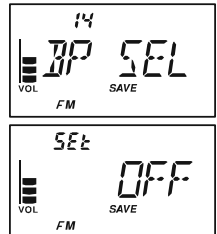

ADVANCED OPERATION

KEYPAD/LCD ILLUMINATION

Your **VX-3R/E** includes a reddish illumination lamp which aids in nighttime operation. The red illumination yields clear viewing of the display in a dark environment, with minimal degradation of your night vision. Three options for activating the lamp are provided:

- KEY 2S - KEY10S: Illuminates the Keypad/LCD for the selected illumination time when any key pressed.
- CONT: Illuminates the Keypad/LCD continuously.
- OFF: Disables the Keypad/LCD lamp.

Here is the procedure for setting up the Lamp mode:

1. Press and hold in the [TXPO] key for one second to enter the Set mode.
2. Rotate the **DIAL** knob to select Set Mode Item 44: LAMP.

Note: Do not forget to pull the **DIAL** knob to rotate the **DIAL** knob.

3. Press the [TXPO] key momentarily to enable adjustment of this Item.
4. Rotate the **DIAL** knob to select one of the three modes described above.
5. When you have made your choice, press the **PTT** switch to save the new setting and return to normal operation.

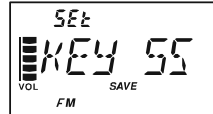

CHECKING THE BATTERY VOLTAGE

The **VX-3R/E**'s microprocessor includes programming which will detect the battery type and measure the current battery voltage.

1. Press and hold in the [TXPO] key for one second to enter the Set mode.
2. Rotate the **DIAL** knob to select Set Mode Item 23: DC VLT.

Note: Do not forget to pull the **DIAL** knob to rotate the **DIAL** knob.

3. Press the [TXPO] key momentarily to display the battery type and the current DC voltage being supplied.

Lit: **FNB-82LI** is in use.

Edc: An external DC source is in use.

4. Press and hold in the [TXPO] key for one second to return to normal operation.



CHANGING THE CHANNEL STEPS

The **VX-3R/E**'s frequency synthesizer provides the option of utilizing channel steps of 5/8.33/9/10/12.5/15/20/25/50/100 kHz per step (optional values differ depending on the band selected). A number of steps may be important to your operating requirements. Automatic ("AUTO") step selection is based on the current operating frequency. The **VX-3R/E** is set up at the factory in the "AUTO" configuration, which probably is satisfactory for most operation. However, if you need to change the channel step increments, the procedure to do so is very easy.

1. Press and hold in the [TXPO] key for one second to enter the Set mode.
2. Rotate the **DIAL** knob to select Set Mode Item 82: STEP.
Note: Do not forget to pull the **DIAL** knob to rotate the **DIAL** knob.
3. Press the [TXPO] key momentarily to enable adjustment of this Item.
4. Rotate the **DIAL** knob to select the new channel step size.
5. When you have made your selection, press the **PTT** switch to save the new setting and return to normal operation.

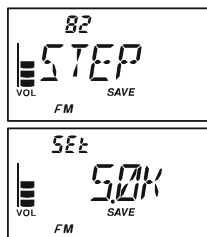

- 1) 9 kHz steps are available only when receiving on the BC band.
- 2) 8.33 kHz steps are available only when receiving on the Air band.
- 3) While operating on the BC band, you may only select channel steps of 9 kHz or 10 kHz; the other step selections are disabled.
- 4) 5 kHz steps are not available for use on 250 - 300 MHz, nor above 580 MHz.

CHANGING THE RECEIVING MODE

The **VX-3R/E** provides for automatic mode changing when the radio is tuned to different operating frequencies. However, should an unusual receiving situation arise in which you need to change to a different receiving mode, just press the [MODE] key. The receiving modes available are:

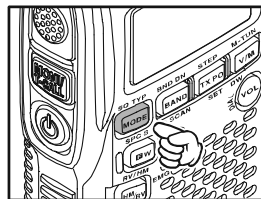

- AUTO: Automatic mode sets the default values for the selected frequency range.
- FM: Narrow-bandwidth FM (used for voice communication)
- AM: Amplitude Modulation
- W-FM: Wide-bandwidth FM (used for high-fidelity broadcasting)



Unless you have a compelling reason to do so, leave the Automatic Mode Selection feature on, this will save time and trouble when changing bands. If you make a mode change for a particular channel or station, you can always store that one channel into memory, as the mode setting will be memorized along with the frequency information.

ADVANCED OPERATION

S-METER SQUELCH

A special S-meter Squelch feature is provided on this radio. This feature allows you to set the squelch so only signals exceeding a certain S-meter level will open the squelch.

To set up the S-meter squelch circuit for operation, use the following procedure:

1. Press and hold in the [TXPO] key for one second to enter the Set mode.
2. Rotate the **DIAL** knob to select Set Mode Item 80: SQSMTR.



Note: Do not forget to pull the **DIAL** knob to rotate the **DIAL** knob.

3. Press the [TXPO] key momentarily to enable adjustment of this Item.
4. Rotate the **DIAL** knob to select the desired signal strength level for the squelch threshold (LVL 1 - LVL8 or OFF).



5. Press the **PTT** switch to save the new setting and return to normal operation.



1) When the S-meter squelch is activated, the S-meter segment corresponding to the squelch threshold which was set by step 4 above will blink.



2) The receiver's squelch will open based on the higher of the levels set by the two squelch systems (Noise Squelch and S-meter Squelch).

For example:

a) If the Noise Squelch (SQL control) is set so that signals at a level of "S-3" will open the squelch, but the S-meter Squelch (Set Mode Item 80) is set to "LVL 5," the squelch will only open on signals which are "S5" or stronger on the S-meter.

b) If the S-meter Squelch is set to "S3," but the Noise Squelch is set to a high level which will only pass signals which are Full Scale on the S-meter, the squelch will only open on signals which are Full Scale on the S-meter. In this case, the Noise Squelch overrides the action of the S-meter Squelch.

CHECKING THE TEMPERATURE

The **VX-3R/E** can display the radio's inside case temperature, measured by an internal sensor.

1. Press and hold in the [**TXPO**] key for one second to enter the Set mode.
2. Rotate the **DIAL** knob to select Set Mode Item 85: TEMP.

Note: Do not forget to pull the **DIAL** knob to rotate the **DIAL** knob.

3. Press the [**TXPO**] key momentarily to indicate the current temperature inside the transceiver's case.
4. Press the [**MODE**] key to select the preferred unit (F (°F) or C (°C)).
5. Press the **PTT** switch to save the new setting and exit to normal operation.

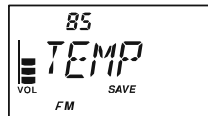

REPEATER OPERATION

Repeater stations, usually located on mountaintops or other high locations, provide a dramatic extension of the communication range for low-powered hand-held or mobile transceivers. The **VX-3R/E** includes a number of features which make repeater operation simple and enjoyable.

REPEATER SHIFTS

Your **VX-3R/E** has been configured, at the factory, for the repeater shifts customary in your country. For the 144 MHz band shift will be 600 kHz. On the 430 MHz band, the shift may be 1.6 MHz, 7.6 MHz, or 5 MHz (USA version).

Depending on the part of the band in which you are operating, the repeater shift may be either downward (◻) or upward (⊕). One of these icons will appear at the top of the LCD when repeater shifts have been enabled.



AUTOMATIC REPEATER SHIFT (ARS)

The **VX-3R/E** provides a convenient Automatic Repeater Shift feature, which causes the appropriate repeater shift to be applied automatically whenever you tune into the designated repeater sub-bands in your country. These sub-bands are shown below.

If the ARS feature does not appear to be working, you may have accidentally disabled it.

To re-enable ARS:

1. Press and hold in the [TXPO] key for one second to enter the Set mode.
2. Rotate the **DIAL** knob to select Set Mode Item 5: ARS.

Note: Do not forget to pull the **DIAL** knob to rotate the **DIAL** knob.

3. Press the [TXPO] key momentarily to enable adjustment of this Item.
4. Rotate the **DIAL** knob to select "ON" (to enable Automatic Repeater Shift).
5. When you have made your selection, press the **PTT** switch to save the new setting and return to normal operation.

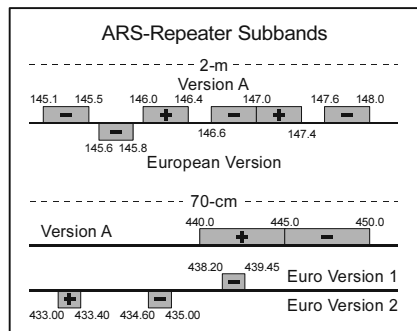
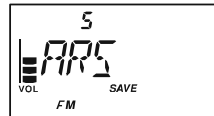

MANUAL REPEATER SHIFT ACTIVATION

If the ARS feature has been disabled, or if you need to set a repeater shift direction other than that established by the ARS, you may set the direction of the repeater shift manually.

To do this:

1. Press and hold in the [TXPO] key for one second to enter the Set mode.
2. Rotate the **DIAL** knob to select Set Mode Item 68: RPT.
Note: Do not forget to pull the **DIAL** knob to rotate the **DIAL** knob.
3. Press the [TXPO] key momentarily to enable adjustment of this Item.
4. Rotate the **DIAL** knob to select the desired shift among “-RPT,” “+RPT,” and “SIMP.”
5. When you have made your selection, press the **PTT** switch to save the new setting and return to normal operation.

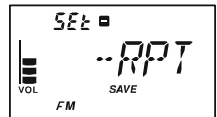

If you make a change in the shift direction, but still have Automatic Repeater Shift engaged (see previous section), when you change frequency (by rotating the DIAL knob, for example) the ARS will over-ride your manual setting of the shift direction. Turn ARS off if you do not wish this to happen.

CHANGING THE DEFAULT REPEATER SHIFTS

If you travel to a different region, you may need to change the default repeater shift so as to ensure compatibility with local operating requirements.

To do this, follow the procedure below:

1. Set the **VX-3R/E**'s frequency to the band on which you wish to change the default repeater shift (144 MHz or 430 MHz Ham Band).
2. Press and hold in the [TXPO] key for one second to enter the Set mode.
3. Rotate the **DIAL** knob to select Set Mode Item 69: RPT.SFT.
Note: Do not forget to pull the **DIAL** knob to rotate the **DIAL** knob.
4. Press the [TXPO] key momentarily to enable adjustment of this Item.
5. Rotate the **DIAL** knob to select the new repeater shift magnitude.
6. When you have made your selection, press the **PTT** switch to save the new setting and return to normal operation.



If you just have one “odd” split that you need to program, don’t change the “default” repeated shifts using this Set Mode Item! Enter the transmit and receive frequencies separately, as shown on page 43.

REPEATER OPERATION

TONE CALLING (1750 Hz)

If your transceiver is **VX-3E** (European version), press and hold in the **T.CALL** switch (just below the **PTT** switch) to generate a 1750-Hz burst tone to access the European repeater. The transmitter will automatically be activated, and a 1750-Hz audio tone will be superimposed on the carrier. Once access to the repeater has been gained, you may release the **T.CALL** switch, and use the **PTT** switch for activating the transmitter thereafter.

If you need to access the repeaters which requires a 1750-Hz burst tone for access by the **VX-3R** (USA/EXP versions), you can set the **MONI** switch to serve as a “Tone Call” switch instead. To change the configuration of this switch, we again use the Set Mode to help us.

1. Press and hold in the [**TXPO**] key for one second to enter the Set mode.
2. Rotate the **DIAL** knob to select Set Mode Item 47: M/T-CL.

Note: Do not forget to pull the **DIAL** knob to rotate the **DIAL** knob.

3. Press the [**TXPO**] key momentarily to enable adjustment of this Set Mode Item.
4. Rotate the **DIAL** knob to select “T-CALL” on the display.
5. Press the **PTT** switch to save the new setting and exit to normal operation.

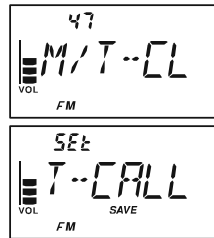

CHECKING THE REPEATER UPLINK (INPUT) FREQUENCY

It often is helpful to be able to check the uplink (input) frequency of a repeater, to see if the calling station is within direct (“Simplex”) range.

To do this, just press the [**HM/RV**] key. You’ll notice that the display has shifted to the repeater uplink frequency. Press the [**HM/RV**] key again to cause operation to revert to normal monitoring of the repeater downlink (output) frequency.



 *The configuration of this key may be set either to “RV” (for checking the input frequency of a repeater), or “HM” (for instant switching to the “Home” channel for the band you are operating on). To change the configuration of this key, use Set Mode Item 36: HM/RV. See page 111.*

NOTE

CTCSS/DCS/EPCS OPERATION

CTCSS OPERATION

Many repeater systems require that a very-low-frequency audio tone be superimposed on your FM carrier in order to activate the repeater. This helps prevent false activation of the repeater by radar or spurious signals from other transmitters. This tone system, called “CTCSS” (Continuous Tone Coded Squelch System), is included in your **VX-3R/E**, and is very easy to activate.



CTCSS setup involves two actions: setting the Tone Frequency and then setting of the Tone Mode. These actions are set up by using the [MODE] key or Set Mode Items 79: SQ TYP and 86: TN FRQ.

1. Press the **[FW]** key, then press the **[MODE]** key. This provides a “Short-cut” to Set Mode Item 79: SQ TYP.
2. Rotate the **DIAL** knob so that “TONE” appears on the display. This activates the CTCSS Encoder, which allows repeater access.
Note: Do not forget to pull the **DIAL** knob to rotate the **DIAL** knob.
3. Rotation of the **DIAL** knob one more “click” in step “2” above will cause the “TSQL” notation to appear. When “TSQL” is displayed, this means that the Tone Squelch system is active, which mutes your **VX-3R/E**’s receiver until it receives a call from another radio sending out a matching CTCSS tone. This can be helpful in a high RF congested location by keeping your radio quiet until a call is received from a specific station.



- You may notice an additional “DCS” icon appearing while you rotate the **DIAL** knob in step 3 above. We’ll discuss the Digital Code Squelch system shortly.
- You may notice “RV TN” indication on the display while you rotate the **DIAL** knob in step 3 above, this means that the Reverse Tone Squelch system is active, which mutes your **VX-3R/E**’s receiver when it receives a call from the radio sending a matched CTCSS tone. The “**T SQ**” icon will blink on the display when the Reverse Tone Squelch system is activated.
- You may notice “PR FRQ” indication on the display while you rotate the **DIAL** knob in step 3 above, this means that User programmed Reverse CTCSS Decoder mutes your **VX-3R/E**’s receiver when it receives a call from the radio sending the CTCSS tone your programmed matching tone (determine from Set Menu Item: 63: PR FRQ) is received. The “**SQ**” icon will appear on the display when the User programmed Reverse CTCSS Decoder is activated.
- You may notice “PAGER” and “MESSAGE” indication on the display while you rotate the **DIAL** knob in step 3 above. These appear when the “Enhanced Paging & Code Squelch” and the “Message Feature” are activated. We’ll discuss these functions later.

CTCSS/DCS/EPCS OPERATION

CTCSS OPERATION

- When you have made your selection of the CTCSS tone mode, press the **PTT** switch to save the new setting.
- Press and hold in the [**TXPO**] key for one second to enter the Set mode.
- Rotate the **DIAL** knob to select Set Mode Item 86: TN FRQ.
Note: Do not forget to pull the **DIAL** knob to rotate the **DIAL** knob.
- Press the [**TXPO**] key momentarily to enable adjustment of the CTCSS frequency.
- Rotate the **DIAL** knob until the display indicates the Tone Frequency you need to be using (ask the repeater owner/operator if you don't know the tone frequency).
- When you have made your selection, press the [**TXPO**] key momentarily, then press the **PTT** switch, to save the new settings and exit to normal operation. This is different from the usual method of restoring normal operation, and it applies only to the configuration of the CTCSS/DCS frequencies.

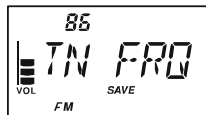

1) Your repeater may or may not re-transmit a CTCSS tone - some systems just use CTCSS to control access to the repeater, but does not pass it along when transmitting. If the S-Meter deflects, but the VX-3R/E is not passing audio, repeat steps "1" through "4" above, but rotate the DIAL so that "TSQ" disappears - this will allow you to hear all traffic on the channel being received.

CTCSS TONE FREQUENCY (Hz)					
67.0	69.3	71.9	74.4	77.0	79.7
82.5	85.4	88.5	91.5	94.8	97.4
100.0	103.5	107.2	110.9	114.8	118.8
123.0	127.3	131.8	136.5	141.3	146.2
151.4	156.7	159.8	162.2	165.5	167.9
171.3	173.8	177.3	179.9	183.5	186.2
189.9	192.8	196.6	199.5	203.5	206.5
210.7	218.1	225.7	229.1	233.6	241.8
250.3	254.1	-	-	-	-

2) During CTCSS operation, you may set up the VX-3R/E so a ringing "bell" sound alerts you to an incoming call. See page 37 for details.

CTCSS/DCS/EPCS OPERATION

DCS OPERATION

Another form of tone access control is Digital Code Squelch, or DCS. It is a newer, more advanced tone system which generally provides more immunity from false paging than does CTCSS. The DCS Encoder/Decoder is built into your **VX-3R/E**, and operation is very similar to that just described for CTCSS. Your repeater system may be configured for DCS. If not, DCS is frequently quite useful in Simplex operation if your friend(s) use transceivers equipped with this advanced feature.



Just as in CTCSS operation, DCS requires that you set the Tone Mode to DCS and that you select a digital code.

1. Press the **[FW]** key, then press the **[MODE]** key. This provides a “Short-cut” to Set Mode Item 79: SQ TYP.
2. Rotate the **DIAL** knob until “DCS” appears on the display; this activates the DCS Encoder/Decoder.
Note: Do not forget to pull the **DIAL** knob to rotate the **DIAL** knob.
3. Press the **PTT** switch to save the new setting.
4. Press and hold in the **[TXPO]** key for one second to enter the Set mode.
5. Rotate the **DIAL** knob to select Set Mode Item 24: DCS CD.
6. Press the **[TXPO]** key momentarily to enable the adjustment of the DCS code.
7. Rotate the **DIAL** knob to select the desired DCS Code (a three-digit number). Ask the repeater owner/operator if you don’t know the DCS Code. If you are working simplex, just set up the DCS Code to be the same as that used by your friend(s).
8. When you have made your selection, press the **[TXPO]** key momentarily, then press the **PTT** switch to save the new settings and exit to normal operation.



1) Remember that DCS is an Encode/Decode system, so your receiver will remain muted until a matching DCS code is received on an incoming transmission. Switch the DCS off when you’re just tuning around the band!

2) During DCS operation, you may set up the VX-3R/E so a ringing “bell” sound alerts you to an incoming call. See page 37 for details.

DCS CODE									
023	025	026	031	032	036	043	047	051	053
054	065	071	072	073	074	114	115	116	122
125	131	132	134	143	145	152	155	156	162
165	172	174	205	212	223	225	226	243	244
245	246	251	252	255	261	263	265	266	271
274	306	311	315	325	331	332	343	346	351
356	364	365	371	411	412	413	423	431	432
445	446	452	454	455	462	464	465	466	503
506	516	523	526	532	546	565	606	612	624
627	631	632	654	662	664	703	712	723	731
732	734	743	754	-	-	-	-	-	-

CTCSS/DCS/EPCS OPERATION

DCS OPERATION

DCS CODE INVERSION

The DCS system was first introduced in the commercial LMR (Land Mobile Radio) service, where it is now in widespread use. DCS is sometime referred to by its different proprietary names, such as DPL® (Digital Private Line®, a registered trademark of Motorola, Inc.).

DCS uses a codeword consisting of a 23-bit frame, transmitted (subaudible) at a data rate of 134.4 bps (bit/sec). Occasionally, signal inversion can result in the complement of a code being sent or received. This prevents the receiver's squelch from opening with DCS enabled, as the decoded bit sequence would not match that selected for operation.

Typical situations that might cause inversion to occur are:

- Connection of an external receiver preamplifier.
- Operating through a repeater.
- Connection of an external linear amplifier.

Note that code inversion does not mean that any of the above listed equipment is defective!

In certain amplifier configurations, the output signal (phase) is inverted from the input. Small signal or power amplifiers having an odd number (1, 3, 5, etc.) of amplification stages may result in inversion of a transmitted or received DCS code. While under most circumstances this should not occur (amplifier designs and industry standards take this into account), if you find that your receiver squelch does not open when both you and the other station are using a common DCS code, you or the other station (but not both) can try the following:

1. Press and hold in the [TXPO] key for one second to enter the Set mode.
2. Rotate the **DIAL** knob to select Set Mode Item 25: DCS RV.

Note: Do not forget to pull the **DIAL** knob to rotate the **DIAL** knob.

3. Press the [TXPO] key momentarily to enable adjustment of this Set Mode Item.
4. Rotate the **DIAL** knob to select one of the following modes:

R-N.T-N: Receive and transmit the Normal DCS Tone.

R-I.T-N: Receive the Inverted DCS Tone and transmit the Normal DCS Tone.

R-B.T-N: Receive both Normal and Inverted DCS Tones and transmit the Normal DCS Tone.

R-N.T-I: Receive the Normal DCS Tone and transmit the Inverted DCS Tone.

R-I.T-I: Receive and transmit the Inverted DCS Tone.

R-B.T-I: Receive both Normal and Inverted DCS Tones and transmit the Inverted DCS Tone.

5. When you have made your selection, press the [TXPO] key momentarily, then press the **PTT** switch, to save the new settings and exit to normal operation.

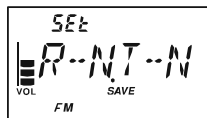
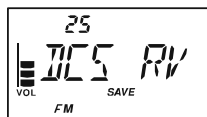

CTCSS/DCS/EPCS OPERATION

DCS OPERATION

This is different from the usual method of restoring normal operation, and it applies only to the configuration of the CTCSS/DCS frequencies. Remember to restore the default setting “R-N-T-N” (Receive and transmit the Normal DCS Tone) when done.

TONE SEARCH SCANNING

In operating situations where you don’t know the CTCSS or DCS tone being used by another station or stations, you can command the radio to listen to the incoming signal and scan in search of the tone being used. Two things must be remembered in this regard:

- You must be sure that your repeater uses the same tone type (CTCSS vs. DCS).
- Some repeaters do not pass the CTCSS tone. You may have to listen to the station(s) transmitting on the repeater uplink (input) frequency in order to allow Tone Search Scanning to work.

To scan for the tone in use:

1. Set the radio up for either CTCSS or DCS Decoder operation (see the previous discussions). In the case of CTCSS, “**T SQ**” will appear on the display; in the case of DCS, “**DCS**” will appear on the display.

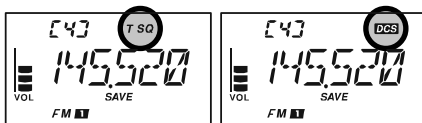

2. Press and hold in the [TXPO] key for one second to enter the Set mode.
3. Rotate the **DIAL** knob to select Set Mode Item 86: TN FRQ when TONE SQL is selected, or Set Mode Item 24: DCS CD during DCS operation.



Note: Do not forget to pull the **DIAL** knob to rotate the **DIAL** knob.

4. Press the [TXPO] key momentarily to enable adjustment of the selected Set Mode Item.
5. Press and hold in the [BAND] key for one second, until “T SRCH” (for CTCSS Tone Search) or “D SRCH” (for DCS Tone Search) appears on the display, then release the [BAND] key to start scanning for the incoming CTCSS or DCS tone/code.



6. When the radio detects the correct tone or code, it will halt on that tone/code, and audio will be allowed to pass. Press the [BAND] key to lock in that tone/code, then press and hold the [TXPO] key for one second to exit to normal operation.

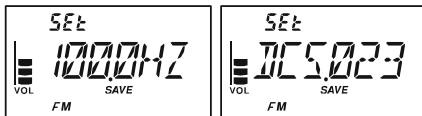

TONE SEARCH SCANNING



If the Tone Scan feature does not detect a tone or code, it will continue to scan indefinitely. When this happens, it may be that the other station is not sending any tone. You can press the PTT switch to halt the scan at any time.

You may listen to the (muted) signal from the other station during Tone Scanning when Set Mode Item 88: TS MUT is set to “OFF.” See page 121 for details. You can also change the Tone Search scanning speed, using Set Mode Item 89: TS SPD. See page 121.

Tone Scanning works either in the VFO or Memory modes.

CTCSS/DCS/EPCS OPERATION

EPCS (ENHANCED PAGING & CODE SQUELCH)

The **VX-3R/E** includes an Enhanced CTCSS tone encoder/decoder and a dedicated micro-processor providing paging and selective calling features. This allows you to place a call to a specific station (Paging), and to receive calls of your choice directed only to you (Code Squelch).

The paging and code squelch systems use two pairs of (alternately switched) CTCSS tones which are stored in the pager memories. Basically, your receiver remains silent until it receives the CTCSS tone pair that matches those stored in the Receiving Pager Memory. The squelch then opens so the caller is heard, and the paging ringer immediately sounds, if activated. When you close the **PTT** switch to transmit, the CTCSS tone pair that is stored in the Transmitting Pager Memory will be transmitted automatically.

On the paged radio, the Code Squelch will close automatically after the incoming page ends. Meanwhile, on the paging radio, the Enhanced Paging and Code Squelch system will be disabled after the **PTT** switch is released after the paging transmission. You may re-activate the Enhanced Paging and Code Squelch system again.

STORING THE CTCSS TONE PAIRS FOR EPCS OPERATION

1. Press and hold in the **[TXPO]** key for one second to enter the Set mode.
2. Rotate the **DIAL** knob to select Set Mode Item 61: PAG.CDR for the Receiving CTCSS Tone Pair or Set Mode Item 62: PAG.CDT for the Transmitting CTCSS Tone Pair.

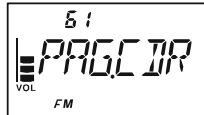

Note: Do not forget to pull the **DIAL** knob to rotate the **DIAL** knob.

3. Press the **[TXPO]** key momentarily to enable adjustment of this Set Mode Item.
4. Rotate the **DIAL** knob to set the CTCSS Tone number which corresponds to the first tone of the CTCSS Tone Pair.
5. Press the **[V/M]** key, then rotate the **DIAL** knob to set the CTCSS Tone number which corresponds to the second tone of the CTCSS Tone Pair.
6. Press the **PTT** switch to save the new setting and exit to normal operation.



The VX-3R/E does not recognize the order of the 1st tone and the 2nd tone. In other words, for example, the VX-3R/E considers both CTCSS pairs "10, 35" and "35, 10" to be identical.

CTCSS/DCS/EPCS OPERATION

EPCS (ENHANCED PAGING & CODE SQUELCH)

ACTIVATING THE ENHANCED PAGING & CODE SQUELCH SYSTEM

1. Press the [F/W] key, then press the [MODE] key. This provides a “Short-cut” to Set Mode Item 79: SQ TYP.
2. Rotate the **DIAL** knob until “PAGER” appears on the display. This activates Enhanced Paging & Code Squelch.
Note: Do not forget to pull the **DIAL** knob to rotate the **DIAL** knob.
3. Press the **PTT** switch to save the new setting and activate the Enhanced Paging & Code Squelch.



To disable the Enhanced Paging & Code Squelch, just repeat the above procedure, rotate the **DIAL** knob to select “OFF” in step 2 above.

When the Enhanced Paging & Code Squelch feature is activated, the “P” notation will appear at the 100 MHz digit of the frequency display.



During Enhanced Paging & Code Squelch operation, you may set up the VX-3R/E so that a ringing “bell” sound alerts you when a call is coming in. See page 37 for details.

CTCSS TONE NUMBER

No.	Hz	No.	Hz	No.	Hz	No.	Hz	No.	Hz
01	67.0	11	94.8	21	131.8	31	171.3	41	203.5
02	69.3	12	97.4	22	136.5	32	173.8	42	206.5
03	71.9	13	100.0	23	141.3	33	177.3	43	210.7
04	74.4	14	103.5	24	146.2	34	179.9	44	218.1
05	77.0	15	107.2	25	151.4	35	183.5	45	225.7
06	79.7	16	110.9	26	156.7	36	186.2	46	229.1
07	82.5	17	114.8	27	159.8	37	189.9	47	233.6
08	85.4	18	118.8	28	162.2	38	192.8	48	241.8
09	88.5	19	123.0	29	165.5	39	196.6	49	250.3
10	91.5	20	127.3	30	167.9	40	199.5	50	254.1

CTCSS/DCS/EPCS OPERATION

EPCS (ENHANCED PAGING & CODE SQUELCH)

PAGING ANSWER BACK

When you press the **PTT** switch to respond to a page call, the **VX-3R/E** transmits the same CTCSS tone pair. This tone pair will open the Code Squelch of the calling station. If you prefer, you can have the **VX-3R/E** respond to page calls automatically (“transpond”). To enable this feature:

1. Press and hold in the [**TXPO**] key for one second to enter the Set mode.

2. Rotate the **DIAL** knob to select Set Mode Item 60: PAG.ABK.

Note: Do not forget to pull the **DIAL** knob to rotate the **DIAL** knob.

3. Press the [**TXPO**] key momentarily to enable adjustment of this Set Mode Item.

4. Rotate the **DIAL** knob to select “ON”.

5. Press the **PTT** switch to save the new setting and exit to normal operation.



The Paging Answer Back feature constitutes a form of “remote control” operation that may be restricted to certain frequencies. U.S. users should confirm the current status of §97.201(b) of the FCC’s rules governing the Amateur service before utilizing this feature on the 144 MHz band.

CTCSS/DCS/EPCS OPERATION

CTCSS/DCS/EPCS BELL OPERATION

During CTCSS Decode, DCS, or EPCS operation, you may set up the **VX-3R/E** so a ringing “bell” sound (or user programmed beep) alerts you to an incoming call. Here is the procedure for activating the CTCSS/DCS/EPCS Bell:

1. Set the operating frequency to the desired channel.
2. Set the transceiver up for CTCSS Decode (“Tone Squelch”), DCS, or EPCS operation, as described previously.
3. Press and hold in the [TXPO] key for one second to enter the Set mode.
4. Rotate the **DIAL** knob to select Set Mode Item 10: BEL.SEL.

Note: Do not forget to pull the **DIAL** knob to rotate the **DIAL** knob.



5. Press the [TXPO] key momentarily to enable adjustment of this Set Mode Item.
6. Rotate the **DIAL** knob to set the desired “bell” sound. The available choices are BELL, USERBP1, USERBP2, USERBP3, or OFF (disable the Bell function).

Note: When User Beep (described later) does not register, USERBP1, USERBP2, or USERBP3 does not appear.



7. Press the [TXPO] key momentarily, then rotate the **DIAL** knob one click counter-clockwise to select Set Mode Item 9: BEL.RNG.
8. Press the [TXPO] key momentarily to enable adjustment of this Set Mode Item.



9. Rotate the **DIAL** knob to set the desired number of rings of the Bell. The available choices are 1 through 20 rings or CONT (continuous ringing).



10. Press the **PTT** switch momentarily to save the new setting and exit to normal operation.

When you are called by a station whose transceiver is sending a CTCSS tone, DCS code, or CTCSS tone pair which matches that set into your Decoder, the Bell will ring in accordance with this programming.

When the CTCSS/DCS/EPCS Bell is activated, the “♥” icon will appear in the display.



To disable the CTCSS/DCS/EPCS Bell function, select the setting of Set Mode Item 10: BEL.SEL to “OFF”.

CTCSS/DCS/EPCS OPERATION

CTCSS/DCS/EPCS BELL OPERATION

PROGRAMMING THE USER BEEP

Three User Beep Memories are provided, allowing you to create a unique original beep tone.

Each User Beep Memory can store up to 64 steps with three octaves (“C1” through “B3”).

1. Press and hold in the [TXPO] key for one second to enter the Set mode.
2. Rotate the **DIAL** knob to select Set Mode Item 15: BP USR.
Note: Do not forget to pull the **DIAL** knob to rotate the **DIAL** knob.
3. Press the [TXPO] key momentarily to enable adjustment of this Set Mode Item.
4. Rotate the **DIAL** knob to select the memory slot into which you wish to store your programmed beep. Available selections are bP1, bP2, and bP3. The previously stored beep will be displayed.
5. Press the [V/M] key to enable programming the beep. Press and hold the [HM/RV] key for one second to clear any previous beep, if desired.
6. Rotate the **DIAL** knob to select the first beep tone of the User Beep.
7. Press the [V/M] key, then rotate the **DIAL** knob to set the length of the first beep tone. Available selections are 1 (0.1 sec) - 250 (2.5 sec).
8. Press the [V/M] key to accept the first beep tone of the User Beep.
9. If you make a mistake, press the [BAND] key to back-space the cursor, then re-enter the correct beep tone or length.
10. Repeat steps 6 - 9 until you have completed the User Beep.
11. When there is a beep tone which you wish to delete, bring the cursor to that beep tone using the [BAND]/[V/M] key, then press the [MODE] key repeatedly until the “dEL” notation appears in the Memory Channel Number display slot. Press and hold in the [MODE] key for one second to delete that beep tone.
12. When you wish to add a beep tone into the beep tone strings, move the cursor to the desired place where you wish to enter the beep tone using the [BAND]/[V/M] key, then press the [MODE] key repeatedly until the “InS” notation is displayed in the Memory Channel Number display slot. Press and hold in the [MODE] key for one second to add the beep tone.

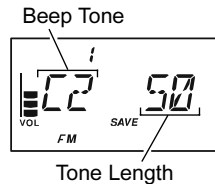

CTCSS/DCS/EPCS OPERATION

CTCSS/DCS/EPCS BELL OPERATION

13. Press and hold the [HM/RV] key for one second to delete all data after the current position that may have previously been stored in the User Beep.
14. When you have programmed User Beep, press the [TXPO] key momentarily to confirm the User Beep.



You may check your work by monitoring the programmed User Beep. To do this, repeat steps 1 - 4 above, then press the [F/W] key.

SPLIT TONE OPERATION

The **VX-3R/E** can be operated in a Split Tone configuration via the Set mode.

1. Press and hold in the [TXPO] key for one second to enter the Set mode.
2. Rotate the **DIAL** knob to select Set Mode Item 81: SQSPLT.
Note: Do not forget to pull the **DIAL** knob to rotate the **DIAL** knob.
3. Press the [TXPO] key momentarily to enable adjustment of this Set Mode Item.
4. Rotate the **DIAL** knob to select “ON” (to enable the Split Tone feature).
5. Press the **PTT** switch momentarily to save the new setting and exit to normal operation.

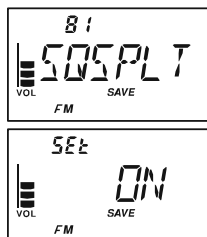

When the Split Tone feature is activated, you can see the following additional parameters after the “MESSAGE” parameter while selecting the Set Mode Item 79: SQ TYP:

D CODE: DCS Encode only

(the “**DCS**” icon will blink during operation)

T DCS: Encodes a CTCSS Tone and Decodes a DCS code

(the “**T**” icon will blink and the “**DCS**” icon will appear during operation)

D TONE: Encodes a DCS code and Decodes a CTCSS Tone

(the “**T SQ**” icon will appear and the “**DCS**” icon will blink during operation)

Select the desired operating mode, from the selections shown above, within Set Mode Item 79: SQ TYP.

NOTE

MEMORY MODE

The **VX-3R/E** provides a wide variety of memory system resources. These include:

- ❑ “Regular” Memory Channels, which include:
 - 900 “Standard” memory channels, numbered “1” through “900.”
 - 99 “Frequency Skip Memories,” numbered “901” through “999.”
 - 11 “Home” channels, providing storage and quick recall of one prime frequency on each operating band.
 - 50 sets of band-edge memories, also known as “Programmable Memory Scan” channels, labeled “L01/U01” through “L50/U50.”
 - 24 Memory Banks, labeled “b 1” through “b24.” Each Memory Bank can be assigned up to 100 channels from the “regular” memory channels.
- ❑ Special Memory Channels, which include:
 - One “Emergency Automatic ID (EAI)” Channel.
 - 10 “Weather Broadcast” Channels.
 - 57 VHF Marine Channels.
 - 89 popular Short-wave Broadcast Station Memory Channels.

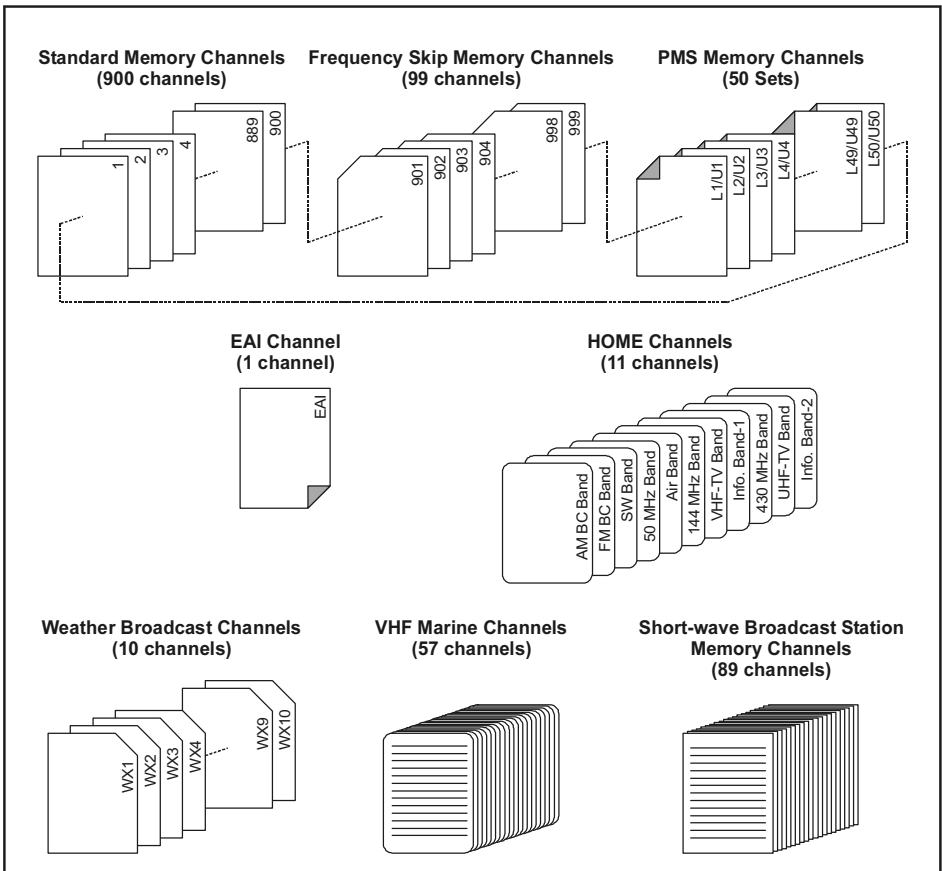

MEMORY MODE (REGULAR MEMORY CHANNEL OPERATION)

MEMORY STORAGE

1. Select the desired frequency while operating in the VFO mode. Be sure to set up any desired CTCSS or DCS tones, as well as any desired repeater offset. The power level may also be set at this time, if you wish to store it.
2. Press and hold in the **[F/W]** key for 1/2 seconds.
3. Within five seconds of releasing the **[F/W]** key, you need to make a decision regarding channel storage. The microprocessor will automatically select the next-available “free” channel (a memory register on which no data has been stored). If you do not wish to make a change and accept the “free” channel, proceed to step 4. If you wish to select a different channel number into which to store the data, rotate the **DIAL** knob to select the desired memory channel.

Note: Do not forget to pull the **DIAL** knob to rotate the **DIAL** knob.

Advice: You may jump 100 memory channels, if you’re in a hurry (101 → 201 → 301 ...), by pressing the **[TXPO]** key (multiple times, if necessary). Any channel that you see with a blinking channel number currently has no data written on it (i.e. the channel is “free”).

4. Press the **[F/W]** key once more to store the frequency into memory.
5. You will still be operating in the “VFO” mode, so you may now enter other frequencies, and store them into additional memory locations, by repeating the above process.

1) You may change the automatic memory channel selection feature to select the “next-highest memory channel above the last-stored memory channel” instead of the “next-available ‘free’ channel” via the Set Mode Item 50: MR

WMD; see page 114.

2) You may disable the memory write function which prevents a memory write operation if you should accidentally perform a wrong key sequence via the Set Mode Item 53: MRPTCT. See page 116 for details. When the memory write protect is activated, the “PROTCT” notation appears on the display while a memory write operation is being performed.

IMPORTANT NOTE

On rare occasions the memorized data may become corrupted by miss operation, or static electricity. When repairs are made the memory data may be lost. Please write down or record the memorized information so you will be able to restore it if needed.

MEMORY MODE (REGULAR MEMORY CHANNEL OPERATION)

MEMORY STORAGE

STORING INDEPENDENT TRANSMIT FREQUENCIES (“ODD SPLITS”)

All memories can store an independent transmit frequency, for operation on repeaters with non-standard shift. To do this:

1. Store the receive frequency using the method already described under MEMORY STORAGE (it doesn't matter if a repeater offset is active).
2. Turn to the desired transmit frequency, then press and hold in the [F/W] key for 1/2 second.
3. Within five seconds of releasing the [F/W] key, rotate the **DIAL** knob to select the same memory channel number as used in step “1” above.

Note: Do not forget to pull the **DIAL** knob to rotate the **DIAL** knob.

4. Press and hold in the **PTT** switch, then press the [F/W] key once more momentarily while holding the **PTT** switch in (this does not key the transmitter).



Whenever you recall a memory which contains independently-stored transmit and receive frequencies, the “ ” indication will appear in the display.



MEMORY RECALL

1. While operating in the VFO mode, press the [V/M] key to enter the Memory mode.
2. Rotate the **DIAL** knob to select the desired channel.

Note: Do not forget to pull the **DIAL** knob to rotate the **DIAL** knob.

3. If you press the [F/W] key momentarily, then rotate the **DIAL** knob, the memory channel will be selected in 10 channels per step.
4. To return to the VFO mode, press the [V/M] key.



*You may change the step of the fast channel selection mode ([F/W] key + **DIAL** knob) via Set Mode Item 51: MRFSTP. See page 116 for details.*

MEMORY MODE (REGULAR MEMORY CHANNEL OPERATION)

HOME CHANNEL MEMORY

A special one-touch “HOME” channel is available for each of the operating bands, to allow quick recall of a favorite operating frequency on each band.

HOME CHANNEL RECALL

1. Press the [FW] key then press the [HM/RV] key to recall the Home Channel on the band group where you are currently operating.
2. Press the [FW] key then press the [HM/RV] key again to return to the previous-used frequency (either a VFO or a memory channel).



The transceiver switches to VFO mode if the **DIAL** knob is turned.



You may disable the above function (automatically switching to the VFO mode) via Set Mode Item 37: HM>VFO.

HOME CHANNEL FREQUENCY CHANGE

The factory defaults for the Home channels are listed below. You may re-program the Home channel in a manner identical to that used for the regular memories:

1. Select the desired frequency, while operating in the VFO mode. Be sure to set up any desired CTCSS or DCS tones, as well as any desired repeater offset. The power level may also be set at this time, if you wish to store it.
2. Press and hold in the [FW] key for 1/2 seconds.
3. While the memory channel number is blinking, just press the [HM/RV] key. The frequency and other data (if any) will now be stored in the special HOME channel register.
4. You may repeat this process on the other operating bands.



The UHF HOME channel is the one used during “Emergency” operation. See page 74 for details regarding this feature.

DEFAULT HOME CHANNELS

OPERATING BAND [BAND NUMBER]	FREQUENCY	
	USA VERSION	EXP/EU VERSION
SW Band [1]	1.800 MHz	1.800 MHz
50 MHz Ham Band [2]	30.000 MHz	30.000 MHz
Air Band [3]	108.000 MHz	108.000 MHz
144 MHz Ham Band [4]	146.520 MHz	144.000 MHz
VHF-TV Band [5]	174.000 MHz	174.000 MHz
Information Band 1 [6]	222.000 MHz	222.000 MHz
430 MHz Ham Band [7]	446.000 MHz	430.000 MHz
UHF-TV Band [8]	470.000 MHz	470.000 MHz
Information Band 2 [9]	860.000 MHz	860.000 MHz
AM Broadcast Band [A]	0.540 MHz	0.540 MHz
FM Broadcast Band [F]	76.000 MHz	76.000 MHz

MEMORY MODE (REGULAR MEMORY CHANNEL OPERATION)

LABELING MEMORIES

You may wish to append an alpha-numeric “Tag” (label) to a memory or memories, to aid in recollection of the channel’s use (such as a club name, etc.). This is easily accomplished using the Set Mode.

1. Recall the memory channel on which you wish to append a label.
2. Press and hold in the [TXPO] key for one second to enter the Set mode.
3. Rotate the **DIAL** knob to select the Set Mode Item 52: MRNAME.
Note: Do not forget to pull the **DIAL** knob to rotate the **DIAL** knob.
4. Press the [TXPO] key momentarily to enable adjustment of this Set Mode Item.
5. Rotate the **DIAL** knob to select the first digit of the desired label.
6. Press the [V/M] key to move to the next character.
7. Repeat steps 5 and 6 to program the remaining letters, numbers, or symbols of the desired label. A total of six characters may be used in the creation of a label.
8. If you make a mistake, press the [BAND] key to back-space the cursor, then re-enter the correct letter, number, or symbol.
9. When you have completed the creation of the label, press the **PTT** switch to save the label and return to memory mode with the alpha-numeric “Tag” (label) displayed.

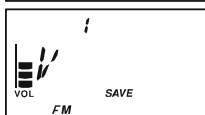
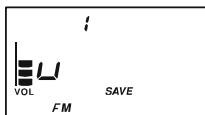

You may check the frequency of the “Tagged” memory channel temporarily by pressing and holding the MONI switch. Release the MONI switch to return to “Tag” display.

To disable the alpha-numeric Tag and enable the frequency display:

1. Set the **VX-3R/E** to the “MR” (Memory Recall) mode, and recall the memory channel on which you wish to disable the alpha-numeric Tag.
2. Press and hold in the [TXPO] key for one second to enter the Set mode.
3. Rotate the **DIAL** knob to select the Set Mode Item 49: MR DSP.
Note: Do not forget to pull the **DIAL** knob to rotate the **DIAL** knob.
4. Press the [TXPO] key momentarily to enable adjustment of this Item’s setting.
5. Rotate the **DIAL** knob to set this Set Mode Item to “FREQ” (thus disabling the alpha-numeric display).
6. Press the **PTT** switch to save the new setting and return to memory mode with frequency display.

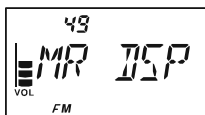

MEMORY MODE (REGULAR MEMORY CHANNEL OPERATION)

LABELING MEMORIES

To enable the alpha-numeric Tag (label) display again, just repeat the above procedure, rotating the **DIAL** knob to select “ALPHA” in step 5 above.



You may set up some memory channels to have their frequencies displayed, while others may be set to have their Name Tag displayed. The selection within Set Mode Item 49: MR DSP is not applied to all memory channels at once.

MEMORY OFFSET TUNING

Once you have recalled a particular memory channel, you may easily tune off that channel, as though you were in the “VFO” mode.

1. With the **VX-3R/E** in the “MR” (Memory Recall) mode, select the desired memory channel.
2. Press the [**F/W**] key, then press the [**V/M**] key to activate the “Memory Tuning” feature. The Memory Channel number will be replaced by “tun.”
3. Rotate the **DIAL** knob, as desired, to tune to a new frequency.



The synthesizer steps selected for VFO operation on the current band will be the steps used during Memory Tuning.

Note: Do not forget to pull the **DIAL** knob to rotate the **DIAL** knob.

4. If you wish to return to the original memory frequency, just press the [**V/M**] key momentarily.
5. If you wish to store a new frequency set during Memory Tuning, just press and hold in the [**F/W**] key for 1/2 seconds, per normal memory storage procedure. The microprocessor will automatically set itself to the next-available clear memory location, and you then press [**F/W**] again to lock in the new frequency.



*1) If you want to replace the original memory contents with those of the new frequency, be sure to rotate the **DIAL** knob to the original memory channel number!*

2) Any required CTCSS/DCS changes, or repeater-offset modifications, must be done before storing the data into the new (or original) memory channel location.

MEMORY MODE (REGULAR MEMORY CHANNEL OPERATION)

MASKING MEMORIES

There may be situations where you want to “Mask” memories so they are not visible during memory selection or scanning. For example, several memories used only in a city you visit infrequently may be stored, then “Masked” until you visit that city, at which time you can “Unmask” them for normal use (except for Memory Channel “1”).

1. Press the [V/M] key, if needed, to enter the MR mode.
2. Press and hold in the [F/W] key for 1/2 seconds, then rotate the **DIAL** knob to select the memory channel to be “Masked” from view.

Note: Do not forget to pull the **DIAL** knob to rotate the **DIAL** knob.

3. Press the [⊗] key. The confirmation message (M-DEL?) will appear on the display. Press the [F/W] key to cancel the Masking Memory procedure, if desired.
4. Press the [⊗] key once more. The display will revert to memory channel #1. If you rotate the **DIAL** knob to the location you just “Masked,” you will observe that it is now invisible.



To Unmask the hidden memory, repeat the above procedure. Press and hold in the [F/W] key for 1/2 seconds, rotate the **DIAL** knob to select the masked memory’s number, then press the [⊗] key to restore the memory channel’s data.



Watch out! You can manually store data over a “Masked” memory, deleting previous data, if you’re not careful. Use the “next available memory” technique storage technique to avoid over-writing a masked memory.

MEMORY MODE (REGULAR MEMORY CHANNEL OPERATION)

MEMORY BANK OPERATION

The large number of memories available in the **VX-3R/E** could be difficult to utilize without some means of organizing them. Fortunately, the **VX-3R/E** includes provision for dividing the memories into as many as 24 Memory Groups, so you can categorize the memories in a manner convenient to you. You may enter and exit the “Memory Group” mode by a single press of the [**BAND**] key, as we shall see below.

ASSIGNING MEMORIES TO A MEMORY BANK

1. Recall the memory channel to be assigned to a Memory Bank.
2. Press and hold in the [**F/W**] key for 1/2 seconds, then rotate the **DIAL** knob to select the Memory Bank number you want as the Memory Bank for this channel (“b 1” ~ “b24,” which is found before memory channel “1”).

Note: Do not forget to pull the **DIAL** knob to rotate the **DIAL** knob.

3. Press the [**F/W**] key momentarily.
4. At this point, the memory channel data is copied into the Memory Bank.

 *1) You may assign one memory channel into several Memory Banks.*

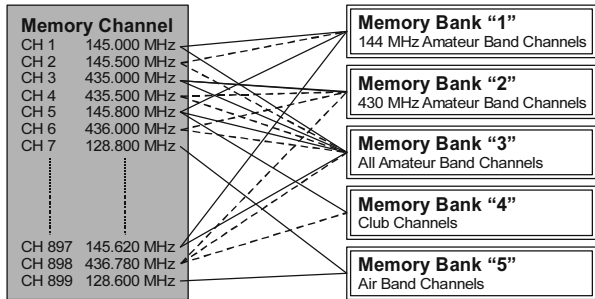

2) The PMS memory channels (L1/U1 through L50/U50) may not be assigned to a Memory Bank.

MEMORY BANK RECALL

1. Press the [**V/M**] key, if needed, to enter the MR mode.
2. Press the [**BAND**] key to activate the “Memory Bank” mode. The “**BANK**” icon and Memory Bank number will appear on the display.
3. Press the [**F/W**] key, and then press the [**BAND**] key.
4. Rotate the **DIAL** knob to select the desired Memory Bank (“BANK 1” through “BANK 24”).

Note: Do not forget to pull the **DIAL** knob to rotate the **DIAL** knob.

5. Press the [**BAND**] key. Now, as you rotate the **DIAL** knob to select memories, you will observe that you can only select memory channels in the current memory bank.

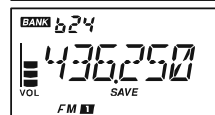

MEMORY MODE (REGULAR MEMORY CHANNEL OPERATION)

MEMORY BANK OPERATION

- To change to another Memory Bank, press the [F/W] key, then press the [BAND] key. Now rotate the **DIAL** knob to select the new Memory Bank, then press the [BAND] key again.
- To exit from Memory Bank operation, just press the [BAND] key. The “**BANK**” icon will disappear from the display, that you are now in the “regular” Memory Recall mode, without utilization of the Memory Banks. The memories stored in the various Banks will remain in those banks. You do not need to store them again.



REMOVING MEMORIES FROM A MEMORY BANK

- Recall the memory channel to be removed from a Memory Bank.
- Press and hold the [F/W] key for one second, then press the [X] key to remove the memory channel data from the Memory bank.

CHANGING A MEMORY BANK'S NAME

You may change the default Memory Bank Names, which are shown on the display while selecting the Memory Bank your desire.

- Press and hold in the [TXPO] key for one second to enter the Set mode.
- Rotate the **DIAL** knob to select the Set Mode Item labeled 11: BNK.NAM.

Note: Do not forget to pull the **DIAL** knob to rotate the **DIAL** knob.



- Press the [TXPO] key momentarily to enable adjustment of this Set Mode Item.
- Rotate the **DIAL** knob to select the memory bank on which you wish to change a label.
- Press the [TXPO] key momentarily to enable changing of the name tag.
- Rotate the **DIAL** knob to select the first digit of the desired label.
- Press the [V/M] key to move to the next character.
- Repeat steps 6 and 7 to program the remaining letters, numbers, or symbols of the desired label. A total of six characters may be used in the creation of a label.
- If you make a mistake, press the [BAND] key to backspace the cursor, then re-enter the correct letter, number, or symbol.
- When you have completed the changes of the label, press the **PTT** switch to save the label and exit.



MEMORY MODE (REGULAR MEMORY CHANNEL OPERATION)

MOVING MEMORY DATA TO THE VFO

Data stored on memory channels can easily be moved to the VFO, if you like.

1. Select the memory channel containing the frequency data to be moved to VFO.
2. Press and hold in the [F/W] key for one second, then press the [V/M] key. The confirmation message (V-WRT?) will appear on the display. Press the [F/W] key to cancel the Moving Memory Data procedure, if desired.
3. Press the [V/M] key once more. The data will now have been copied to the VFO, although the original memory contents will remain intact on the previously stored channel.



If a Split Frequency Memory channel was transferred, the Tx frequency will be ignored (you will be set up for Simplex operation on the Receive frequency).

MEMORY ONLY MODE

Once memory channel programming has been completed, you may place the radio in a “Memory Only” mode, whereby VFO operation is impossible. This may be particularly useful during public-service events, where a number of operators may be using the radio for first time, and ultimate simplicity of channel selection is desired.

To place the radio into the Memory Only mode, turn the radio off. Now press and hold in the [V/M] key while turning the radio on. To return to normal operation, repeat the above power-on procedure.

MEMORY MODE (SPECIAL MEMORY CHANNEL OPERATION)

The **VX-3R/E** provides Special Memory Channels, which made up of:

- 10 “Weather Broadcast” Channels.
- 281 VHF Marine Channels
- 89 popular Short-wave Broadcast Station Memory Channels.

You may assign the Special Memory Channels to a Memory Bank. See page 48 regarding Memory Bank Operation for details.

WEATHER BROADCAST CHANNELS

The VHF Weather Broadcast Station Memory Channel Bank has been pre-programmed at the factory, for quick selection of NOAA weather information stations.

1. Press the **[F/W]** key, then press the **[⊗]** key, to recall the Special Memory Menu.
2. Press the **[BAND]** key, repeatedly if necessary to select the “WX CH” (thus recalling the Weather Broadcast Memory Bank).
3. Rotate the **DIAL** knob to select the desired Weather Broadcast channel.

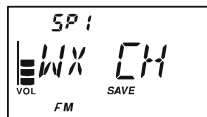

Note: Do not forget to pull the **DIAL** knob to rotate the **DIAL** knob.

4. If you wish to scan this bank to search for louder stations, just press the **PTT** switch. When the scanner pauses on a station, press the **PTT** switch once to halt the scan, or press it twice to restart the scan.
5. To exit to normal operation, press the **[V/M]** key, or press **[F/W]** key followed by the **[⊗]** key.



CH	FREQUENCY	CH	FREQUENCY
1	162.550 MHz	6	162.500 MHz
2	162.400 MHz	7	162.525 MHz
3	162.475 MHz	8	161.650 MHz
4	162.425 MHz	9	161.775 MHz
5	162.450 MHz	10	163.275 MHz



1) In the event of extreme weather disturbances, such as storms and hurricanes, the NOAA (National Oceanic and Atmospheric Administration) sends a weather alert accompanied by a 1050 Hz tone and subsequent weather report on one of the NOAA weather channels. You may disable the Weather Alert tone via Set Mode Item 93: WX ALT, if desired. See page 122.

2) You may append and display an alpha-numeric “Tag” (label) to a Weather Broadcast channel or channels. See page 45 regarding the labeling of a memory for details.

MEMORY MODE (SPECIAL MEMORY CHANNEL OPERATION)

VHF MARINE CHANNELS

Another special Memory Bank contains VHF Marine Channels, pre-programmed at the factory, for quick selection.

1. Press the **[F/W]** key, then press the **[⊗]** key, to recall the Special Memory Menu.
2. Press the **[BAND]** key, repeatedly if necessary, to select “INTVHF” (thus recalling the Marine Channel Memory Bank).
3. Rotate the **DIAL** knob to select any of 57 available VHF Marine Channels.



Note: Do not forget to pull the **DIAL** knob to rotate the **DIAL** knob.

4. Press the **[HM/RV]** key to monitor the opposite frequency while recalling the semi-duplex channel (such as Channel “1”). Press the **[HM/RV]** key again to revert to normal monitoring.
5. To exit to normal operation, press the **[V/M]** key, or press **[F/W]** key followed by the **[⊗]** key.



VHF MARINE CHANNEL FREQUENCY LIST

CH No.	FREQUENCY (MHz)		CH No.	FREQUENCY (MHz)		CH No.	FREQUENCY (MHz)		CH No.	FREQUENCY (MHz)	
1	156.050	160.650	15	156.750	60	156.025	160.625	74	156.725		
2	156.100	160.700	16	156.800	61	156.075	160.675	75	156.775		
3	156.150	160.750	17	156.850	62	156.125	160.725	76	156.825		
4	156.200	160.800	18	156.900	161.500	63	156.175	160.775	77	156.875	
5	156.250	160.850	19	156.950	161.550	64	156.225	160.825	78	156.925	161.525
6	156.300		20	157.000	161.600	65	156.275	160.875	79	156.975	161.575
7	156.350	160.950	21	157.050	161.650	66	156.325	160.925	80	157.025	161.625
8	156.400		22	157.100	161.700	67	156.375		81	157.075	161.675
9	156.450		23	157.150	161.750	68	156.425		82	157.125	161.725
10	156.500		24	157.200	161.800	69	156.475		83	157.175	161.775
11	156.550		25	157.250	161.850	70	156.525		84	157.225	161.825
12	156.600		26	157.300	161.900	71	156.575		85	157.275	161.875
13	156.650		27	157.350	161.950	72	156.625		86	157.325	161.925
14	156.700		28	157.400	162.000	73	156.675		87	157.375	161.975
									88	157.425	162.025

MEMORY MODE (SPECIAL MEMORY CHANNEL OPERATION)

SHORT-WAVE BROADCAST STATION MEMORY CHANNELS

A large number of Short-Wave Broadcast Station Memory Channels have also been pre-programmed at the factory, for convenient selection of broadcast stations.

1. Press the **[FW]** key, then press the **[⊗]** key, to recall the Special Memory Menu.
2. Press the **[BAND]** key to select "RADIO" (thus recalling the Broadcast Station Channel Memory Bank).
3. Rotate the DIAL knob to select any of 89 available Broadcast Stations.

Note: Do not forget to pull the **DIAL** knob to rotate the **DIAL** knob.

4. Press and hold the **MONI** switch to display the receiving frequency "Station's Frequency" (and disabling the squelch). Release the **MONI** switch to return to "Station Name" display.
5. To exit to normal operation, press the **[V/M]** key, or press **[FW]** key followed by the **[⊗]** key.

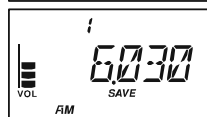
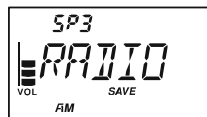

BROADCAST STATION FREQUENCY LIST

Ch No.	Freq. (MHz)	MODE	Tag	Station Name	Ch No.	Freq. (MHz)	MODE	Tag	Station Name
1	6.030	AM	VOA	Voice of America	45	9.650	AM	SPAIN	Radio Exterior de Espana
2	6.160	AM	VOA	Voice of America	46	11.880	AM	SPAIN	Radio Exterior de Espana
3	9.760	AM	VOA	Voice of America	47	11.910	AM	SPAIN	Radio Exterior de Espana
4	11.965	AM	VOA	Voice of America	48	15.290	AM	SPAIN	Radio Exterior de Espana
5	9.955	AM	CANADA	Radio Canada International	49	6.055	AM	NIKKEI	Radio Nikkei
6	9.600	AM	CANADA	Radio Canada International	50	7.315	AM	NORWAY	Radio Norway International
7	11.715	AM	CANADA	Radio Canada International	51	9.590	AM	NORWAY	Radio Norway International
8	11.955	AM	CANADA	Radio Canada International	52	9.925	AM	NORWAY	Radio Norway International
9	6.195	AM	BBC	British Broadcasting Corporation	53	9.985	AM	NORWAY	Radio Norway International
10	9.410	AM	BBC	British Broadcasting Corporation	54	6.065	AM	SWEDEN	Radio Sweden
11	12.095	AM	BBC	British Broadcasting Corporation	55	9.490	AM	SWEDEN	Radio Sweden
12	15.310	AM	BBC	British Broadcasting Corporation	56	15.240	AM	SWEDEN	Radio Sweden
13	6.090	AM	FRANCE	Radio France International	57	17.505	AM	SWEDEN	Radio Sweden
14	9.790	AM	FRANCE	Radio France International	58	6.120	AM	FINLAN	Radio Finland
15	11.670	AM	FRANCE	Radio France International	59	9.560	AM	FINLAN	Radio Finland
16	15.195	AM	FRANCE	Radio France International	60	11.755	AM	FINLAN	Radio Finland
17	6.000	AM	DW	Deutsche Welle	61	15.400	AM	FINLAN	Radio Finland
18	6.075	AM	DW	Deutsche Welle	62	5.920	AM	RUSSIA	Voice of Russia
19	9.650	AM	DW	Deutsche Welle	63	5.940	AM	RUSSIA	Voice of Russia
20	9.735	AM	DW	Deutsche Welle	64	7.200	AM	RUSSIA	Voice of Russia
21	5.990	AM	ITALY	Italian Radio International	65	12.030	AM	RUSSIA	Voice of Russia
22	5.575	AM	ITALY	Italian Radio International	66	7.465	AM	ISRAEL	Israel Broadcasting Authority
23	9.675	AM	ITALY	Italian Radio International	67	11.585	AM	ISRAEL	Israel Broadcasting Authority
24	17.780	AM	ITALY	Italian Radio International	68	15.615	AM	ISRAEL	Israel Broadcasting Authority
25	7.170	AM	TURKEY	Voice of Trukey	69	17.535	AM	ISRAEL	Israel Broadcasting Authority
26	7.270	AM	TURKEY	Voice of Trukey	70	6.045	AM	INDIA	All India Radio (AIR)
27	9.560	AM	TURKEY	Voice of Trukey	71	9.595	AM	INDIA	All India Radio (AIR)
28	11.690	AM	TURKEY	Voice of Trukey	72	11.620	AM	INDIA	All India Radio (AIR)
29	9.660	AM	VATICN	Vatican Radio	73	15.020	AM	INDIA	All India Radio (AIR)
30	11.625	AM	VATICN	Vatican Radio	74	7.160	AM	CHINA	China Radio International (CRI)
31	11.830	AM	VATICN	Vatican Radio	75	7.190	AM	CHINA	China Radio International (CRI)
32	15.235	AM	VATICN	Vatican Radio	76	9.785	AM	CHINA	China Radio International (CRI)
33	5.955	AM	NEDERL	Radio Nederland	77	11.885	AM	CHINA	China Radio International (CRI)
34	6.020	AM	NEDERL	Radio Nederland	78	6.135	AM	KOREA	Radio Korea
35	5.895	AM	NEDERL	Radio Nederland	79	7.275	AM	KOREA	Radio Korea
36	11.655	AM	NEDERL	Radio Nederland	80	9.570	AM	KOREA	Radio Korea
37	5.985	AM	CZECH	Radio Liberty	81	13.670	AM	KOREA	Radio Korea
38	7.165	AM	CZECH	Radio Liberty	82	6.165	AM	JAPAN	Radio Japan
39	9.455	AM	CZECH	Radio Liberty	83	7.200	AM	JAPAN	Radio Japan
40	11.860	AM	CZECH	Radio Liberty	84	9.750	AM	JAPAN	Radio Japan
41	9.780	AM	PORTUG	Radio Portugal	85	11.860	AM	JAPAN	Radio Japan
42	11.630	AM	PORTUG	Radio Portugal	86	5.995	AM	AUSTRA	Radio Australia
43	15.550	AM	PORTUG	Radio Portugal	87	9.580	AM	AUSTRA	Radio Australia
44	21.655	AM	PORTUG	Radio Portugal	88	9.660	AM	AUSTRA	Radio Australia
					89	12080	AM	AUSTRA	Radio Australia

SCANNING

The **VX-3R/E** allows you to scan just the memory channels, the entire operating band, or a portion of that band. It will halt on signals encountered, so you can talk to the station(s) on that frequency, if you like.

Scanning operation is basically the same in each of the above modes. Before you begin, take a moment to select the way in which you would like the scanner to resume scanning after it halts on a signal.

SETTING THE SCAN-RESUME MODE

Eleven options for the Scan-Resume mode are available:

2 SEC - 10 SEC: In this mode, the scanner will halt on a signal it encounters, and will hold there for the selected resume time. If you do not take action to disable the scanner within that time period, the scanner will resume even if the stations are still active.

BUSY: In this mode, the scanner will halt on a signal it encounters. When the carrier has dropped because the other station(s) ceased transmission, the scanner will resume. In the case of constant-carrier signals like Weather Station broadcasts, the scanner will likely remain on this frequency indefinitely. The Scan Re-start Delay time (default interval: 2 seconds) is set by the Set Mode Item 76: SCN.STR.

HOLD: In this mode, the scanner will halt on a signal it encounters. It will not restart automatically; you must manually re-initiate scanning if you wish to resume.

To set the Scan-Resume mode:

1. Press and hold in the **[TXPO]** key for one second to enter the Set mode.
2. Rotate the **DIAL** knob to select Set Mode Item 75: SCN.RSM.

Note: Do not forget to pull the **DIAL** knob to rotate the **DIAL** knob.

3. Press the **[TXPO]** key momentarily to enable adjustment of this Set Mode Item.
4. Rotate the **DIAL** knob to select the desired scan-resume mode described above.

5. When you have made your selection, press the PTT switch to save the new setting and exit to normal operation.



The default condition for this Set Mode Item is "5 SEC."

To set the Scan-Restart Delay Time:

1. Press and hold in the [TXPO] key for one second to enter the Set mode.
2. Rotate the **DIAL** knob to select Set Mode Item 76: SCN.STR.
Note: Do not forget to pull the **DIAL** knob to rotate the **DIAL** knob.
3. Press the [TXPO] key momentarily to enable adjustment of this Set Mode Item.
4. Rotate the **DIAL** knob to select the desired Scan-Restart Delay Time. Available selections are 100 - 900 MS (100 MS/step) and 1 - 10 SEC (0.5 SEC/step).
5. When you have made your selection, press the **PTT** switch to save the new setting and exit to normal operation.



The default condition for this Set Mode Item is “2 SEC.”

VFO SCANNING

This mode allows you to scan on the VFO mode.

1. Select the VFO mode by pressing the **[V/M]** key, if necessary.
2. Press and hold in the **[BAND]** key for one second, and rotate the **DIAL** knob *while holding in the [BAND] key* to select the bandwidth for the VFO scanner. Available selections are ± 1 MHz, ± 2 MHz, ± 5 MHz, BAND, ALL, and PMS-X.



± 1 MHz, ± 2 MHz, ± 5 MHz: The scanner will sweep frequencies within the selected bandwidth.

BAND: The scanner will sweep frequencies only on the current band.

ALL: The scanner will sweep all frequencies between 1.8 MHz and 999.99 MHz (except the FM Broadcast Band: 76 - 107 MHz).

PMS-X: The scanner will sweep frequencies within the currently-selected PMS frequency pair. See page 61 for details.

Note: Do not forget to pull the **DIAL** knob to rotate the **DIAL** knob.

3. Release the **[BAND]** key to start scanning.
4. When the scanner encounters a signal strong enough to open the squelch, the scanner will halt temporarily; the decimal point of the frequency display will blink during this “Pause” condition.
5. The scanner will then resume according to the Scan-Resume mode selected in the previous section.
6. To cancel scanning, press the **PTT** switch or **[V/M]** key.



1) When you start scanning, the VX-3R/E will be changing frequency in the upward direction. If you want to change direction of the scan while it is underway, rotate the DIAL knob one click in the opposite direction (in this case, one click counter-clockwise). You'll see the scanner turn around and change frequency downward!

2) You may change the scanner's method of operation so the VFO frequency will jump to the low band edge of the next band when the VFO frequency reaches the high edge of the current band (or vice versa). See page 121 regarding Set Mode Item 90: VFO MD.

VFO SCANNING

HOW TO SKIP (OMIT) A FREQUENCY DURING VFO SCAN

If the VFO scan stops on a frequency or frequencies that you do not need (such as a spurious radiation from a television), such frequencies can be “skipped” during VFO scanning. A special “Frequency Skip Memory” bank is reserved to store these frequencies.

To skip a frequency during VFO scanning:

1. While VFO scanning is stopped on the frequency that you do not need, press and hold the **[F/W]** key for 1/2 seconds, then rotate the **DIAL** knob to select the desired Frequency Skip Memory channel (901 - 999). The microprocessor will automatically select the next-available “free” Frequency Skip Memory channel (a memory register on which no data has been stored). If you see that any blinking channel number, it means that the channel currently has no data written on it (i.e. the channel is “free”).
Note: Do not forget to pull the **DIAL** knob to rotate the **DIAL** knob.
2. Press the **[F/W]** key to store the frequency into the Frequency Skip Memory. It will now be ignored during VFO scanning.

To re-institute a frequency into the VFO scan loop:

1. Press the **[V/M]** key, if needed, to enter the MR mode.
2. Press and hold in the **[F/W]** key for 1/2 second, then rotate the **DIAL** knob to select the memory channel to be re-instituted.
Note: Do not forget to pull the **DIAL** knob to rotate the **DIAL** knob.
3. Press the **[X]** key to delete the channel from the Frequency Skip Memory; this will restore the frequency into the VFO scan loop.

The VX-3R/E has 99 VFO Frequency Skip Memory Channels.

SETTING THE SQUELCH LEVEL DURING ACTIVE SCANNING OPERATION

The **VX-3R/E** allows adjustment of the Squelch level “on the fly” while you are scanning.

1. While the scanner is engaged, press the **[F/W]** key. Then press the **[MONI]** key (the current squelch level will appear in the Memory Channel Number display slot in the frequency display).



2. Rotate the **DIAL** to select the desired Squelch level.
Note: Do not forget to pull the **DIAL** knob to rotate the **DIAL** knob.
3. Press the **PTT** switch momentarily to save the new setting and exit to normal operation. In this case, pressing the **PTT** switch this one time will not cause scanning to stop.

MEMORY SCANNING

Memory scanning is also easy to initiate:

1. Set the radio to the Memory mode by pressing the [V/M] key, if necessary.

2. Press and hold in the [BAND] key for one second, and rotate the **DIAL** knob *while holding in the [BAND] key* to select the desired Memory Scan mode. Available selections are ALL CH, TAG1, TAG2, BAND, and PMS-X.



ALL CH: The scanner sweeps all Memory channels.

TAG1: The scanner sweeps only those Memory channels with the same first digit of the alpha/numeric tag as the first channel on which scanning started.

TAG2: The scanner sweeps only those Memory channels with the same first and second digits of the alpha/numeric tag as the first channel on which scanning started.

BAND: The scanner sweeps only those Memory channels which are memorized on the same operating band as the first channel on which scanning started.

PMS-X: The scanner will sweep frequencies within the currently-selected PMS frequency pair. See page 61 for details.

Note: Do not forget to pull the **DIAL** knob to rotate the **DIAL** knob.

3. Release the [BAND] key to initiate scanning.

4. As with VFO scanning, the scanner will halt on any signal encountered that is strong enough to open the squelch; it will then resume scanning according to the Scan-Resume mode set previously. When there are no memory channels corresponding to the selected Memory Scan mode, the “MS ERR” notation will appear on the display.



5. To cancel scanning, press the **PTT** switch or [V/M] key.

MEMORY SCANNING

HOW TO SKIP (OMIT) A CHANNEL DURING MEMORY SCAN OPERATION

As mentioned previously, some continuous-carrier stations like a Weather Broadcast station will seriously impede scanner operation if you are using the “Carrier Drop” Scan-Resume mode, as the incoming signal will not pause long enough for the transceiver to resume scanning. Such channels may be “Skipped” during scanning, if you like:

1. Recall the Memory Channel to be skipped during scanning.
2. Press and hold the [TXPO] key for one second to enter the Set mode.
3. Rotate the **DIAL** knob to select the Set Mode Item 54: MRSKIP.
Note: Do not forget to pull the **DIAL** knob to rotate the **DIAL** knob.
4. Press the [TXPO] key momentarily to enable adjustment of this Set Mode Item.
5. Rotate the **DIAL** knob so as to select “SKIP.” The current Memory Channel will now be ignored during scanning. The “ONLY” selection is used for “Preferential Memory Scan,” described in the next column.
6. When you have made your selection, press the **PTT** switch to save the setting and exit to normal operation.



When you recall the “skipped” memory channel manually, a small “▶” icon will appear at the above of the volume level indicator, indicating it is to be ignored during scanning.



To re-institute a channel into the scanning loop, select “OFF” in step 5 above (the “Skipped” channel will, of course, still be accessible via manual channel selection methods using the **DIAL** knob in the MR mode, whether or not it is locked out of the scanning loop).

One Touch Memory Skip

If the scanner repeatedly stops on a channel due to temporary noise or interference while Memory Channel Scan is activated, it is a simple operation to mark it to be skipped (except for Memory Channel “1”).

To skip a channel temporarily, press the [FW] key, and then press the [VM] key while the scanner has stopped on the channel to be skipped. The scanner will immediately resume, and that channel will be assigned to the “skipped” memory channel.

To re-institute a channel into the scanning loop, perform the “How to Skip (Omit) a Channel during Memory Scan Operation” described previously, then select “OFF” in step 5.

MEMORY SCANNING

PREFERENTIAL MEMORY SCAN

The **VX-3R/E** also allows you to set up a “Preferential Scan List” of channels which you can “flag” within the memory system. These channels are designated by a blinking “▶” icon when you have selected them, one by one, for the Preferential Scan List.

When you initiate memory scanning, the scan begins on a channel with the blinking “▶” icon appended; only those channels bearing the blinking “▶” icon will be scanned. If you initiate scanning on a channel that does not have the blinking “▶” icon appended, you will scan all channels including those with the blinking “▶” icon appended.

Here is the procedure for setting up and using the Preferential Scan List:

1. Recall the Memory Channel, which you wish to add to the Preferential Scan List.
2. Press and hold in the [TXPO] key for one second to enter the Set mode.
3. Rotate the **DIAL** knob to select Set Mode Item 54: MRSKIP.

Note: Do not forget to pull the **DIAL** knob to rotate the **DIAL** knob.

4. Press the [TXPO] key momentarily to enable adjustment of this Set Mode Item.
5. Rotate the **DIAL** knob to select “ONLY.”
6. When you have made your selection, press the **PTT** switch to save the settings and exit to normal operation.



To initiate Preferential Memory Scan:

1. Press the [V/M] key momentarily to enter the Memory Recall mode, if you are not using memories already.
2. Rotate the **DIAL** to select any channel which has a blinking “▶” icon appended to the channel number.

Note: Do not forget to pull the **DIAL** knob to rotate the **DIAL** knob.

3. Press and hold in the [BAND] key for one second, and rotate the **DIAL** knob while holding in the [BAND] key, to select the desired Memory Scan mode.



ALL CH: The scanner sweeps all Memory channels.

TAG1: The scanner sweeps only those Memory channels with the same first digit of the alpha/numeric tag as the first channel on which scanning started.

TAG2: The scanner sweeps only those Memory channels with the same first and second digits of the alpha/numeric tag as the first channel on which scanning started.

BAND: The scanner sweeps only those Memory channels which are memorized on the same operating band as the first channel on which scanning started.

PMS-X: The scanner will sweep frequencies within the currently-selected PMS fre-

MEMORY SCANNING





quency pair. See next chapter for details.

- Release the **[BAND]** key to initiate Preferential Memory Scanning. Only the channels that have a blinking “▶” icon appended to the channel number will be scanned.

MEMORY BANK SCAN

When the Memory Bank feature is engaged, the scanner sweeps only memory channels in the current Memory Bank. However, if the Memory Bank Link Scan feature is enabled, you may sweep the memory channels in several Memory Banks which you have selected.

To enable the Memory Bank Link Scan feature:

- Set the radio to the Memory mode by pressing the **[V/M]** key, if necessary.
- Press the **[BAND]** key to activate the “Memory Bank” mode. The “**BANK**” icon and Memory Bank number will appear on the display.
 
- Press the **[F/W]** key, followed by the **[BAND]** key.
- Rotate the **DIAL** knob to select the first Memory Bank (“BANK 1” ~ “BANK24”) you wish to sweep using Memory Bank Link Scan.
 
- Press the **[V/M]** key momentarily. A small blinking “▶” icon will appear at the above of the volume level indicator, indicating this Memory Bank will now be swept during Memory Bank Scan.
 
- Repeat steps 4 and 5 above, to append the blinking “▶” icon to any other Memory Banks you wish to sweep.
- Press the **[BAND]** key.
- Now, press and hold in the **[BAND]** key for one second to initiate the Memory Bank Link Scan.
- To remove a Memory Bank from the Memory Bank Link Scan, repeat steps 1 - 5 above, to delete the blinking “▶” icon from the Memory Bank number indication.
 

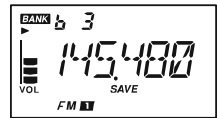

PROGRAMMABLE (BAND LIMIT) MEMORY SCAN (PMS)

This feature allows you to set sub-band limits for either scanning or manual VFO operation. For example, you might wish to set up a limit (in North America) of 144.300 MHz to 148.000 MHz, to prevent encroachment into the SSB/CW “Weak Signal” portion of the band below 144.300 MHz. Here’s how to do this:

1. Set the radio to the VFO mode by pressing the [V/M] key, if necessary.
2. Using the techniques learned earlier in the above procedures, store 144.300 MHz into Memory Channel #L1 (the “L” designates the Lower sub-band limit).
3. Likewise, store 148.000 MHz into Memory Channel #U1 (the “U” designates the Upper sub-band limit).
4. Set the radio to the Memory mode by pressing the [V/M] key.
5. Press and hold in the [BAND] key for one second and rotate the **DIAL** knob *while holding in the [BAND] key* to select the desired PMS frequency pair (PMSxx). Then release the [BAND] key to initiate the Programmable (Band Limit) Memory Scan. The Memory Channel number will be replaced by “Pxx”. Tuning and scanning will now be limited within the just-programmed range.

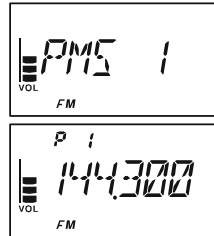

Note: Do not forget to pull the **DIAL** knob to rotate the **DIAL** knob.

6. 50 pairs of Band Limit memories, labeled L1/U1 through L50/U50 are available. You therefore can set upper and lower operation limits on a number of bands, if you like.

PRIORITY CHANNEL SCANNING (DUAL WATCH)

The **VX-3R/E**'s scanning features include a two-channel scanning capability, which allows you to operate on a VFO or Memory channel, while periodically checking a user-defined Memory Channel for activity. If a station is received on the Memory Channel which is strong enough to open the Squelch, the scanner will pause on that station in accordance with the Scan-Resume mode set via Set Mode Item 75: SCN.RSM. See page 54.

Here is the procedure for activating Priority Channel Dual Watch operation:

1. Press the **[V/M]** key momentarily to enter the Memory Recall mode, if you are not using memories already.
2. Press and hold in the **[F/W]** key for one second, then rotate **DIAL** knob to select the memory channel you wish to be the "Priority" channel.

Note: Do not forget to pull the **DIAL** knob to rotate the **DIAL** knob.

3. Press the **[BAND]** key. The "**PRI**" icon will appear above of the volume level indicator, indicating it is the Priority channel.
4. Now set the **VX-3R/E** for operation on another memory channel, or on a VFO frequency.
5. Press and hold in the **[V/M]** key for one second. The display will remain on the VFO or memory channel selected. However, the "**DW**" icon will appear on the display, and every five seconds the **VX-3R/E** will check the Priority Channel for activity. If a station appears on the Priority Channel, the radio will pause on that channel, as described previously.



The receiving time interval (ratio) between the current channel (or VFO frequency) and Priority channel may be customized via Set Mote Item 65: PRI.TMR.

To set the receiving time interval:

1. Press and hold in the **[TXPO]** key for one second to enter the Set mode.
2. Rotate the **DIAL** knob to select Set Mode Item 65: PRI.TMR.
Note: Do not forget to pull the **DIAL** knob to rotate the **DIAL** knob.
3. Press the **[TXPO]** key momentarily to enable adjustment of this Set Mode Item.
4. Rotate the **DIAL** knob to select the desired time interval. Available selections are 0.1S - 0.5S (0.5S/step) and 1.0S - 1.0S (0.5S/step).
5. When you have made your selection, press the **PTT** switch to save the new setting and exit to normal operation.



The default condition for this Set Mode Item is "5.0S."

SCANNING

PRIORITY CHANNEL SCANNING (DUAL WATCH)

PRIORITY REVERT MODE

During Priority channel operation (Dual Watch), a special feature is available which will allow you to move to the Priority Channel instantly, without waiting for activity to appear on the Priority Channel.

When this feature is enabled, and priority monitoring is engaged, just press the microphone's **PTT** switch. Operation will instantly revert to the Priority Channel.

To enable Priority Revert operation:

1. Press and hold in the [**TXPO**] key for one second to enter the Set mode.

2. Rotate the **DIAL** knob to select Set Mode Item 64: PRI.RVT.

Note: Do not forget to pull the **DIAL** knob to rotate the **DIAL** knob.

3. Press the [**TXPO**] key momentarily to enable adjustment of this Set Mode Item.

4. Rotate the **DIAL** knob so as to select "ON."

5. When you have made your selection, press the **PTT** switch to save the settings and exit to normal operation.

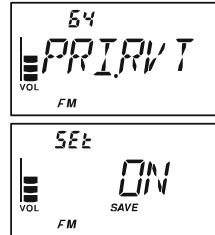

To disable Priority Revert operation, select "OFF" in step 4 above.

AUTOMATIC LAMP ILLUMINATION ON SCAN STOP

The **VX-3R/E** will automatically illuminate the LCD Lamp whenever the scanner stops on a signal; this allows you to see the frequency of the incoming signal better at night. Note that this will, of course, increase the battery consumption, so be sure to switch it off during the day (the default condition for this feature is “ON”).

The procedure for disabling the Scan Lamp is:

1. Press and hold in the **[TXPO]** key for one second to enter the Set mode.
2. Rotate the **DIAL** knob to select Set Mode Item 74: SCN.LMP.
Note: Do not forget to pull the **DIAL** knob to rotate the **DIAL** knob.
3. Press the **[TXPO]** key momentarily to enable adjustment of this Set Mode Item.
4. Rotate the **DIAL** knob to set this Set Mode Item to “OFF.”
5. When you have made your selection, press the **PTT** switch to save the setting and exit to normal operation.

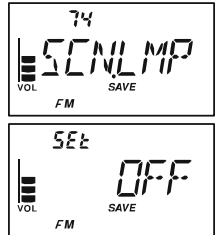

BAND EDGE BEEPER

The **VX-3R/E** will automatically “beep” when a band edge is encountered during scanning (either in standard VFO scanning or during PMS operation). You may enable this feature (band edge beeper) when the frequency reaches the band edge while selecting the VFO frequency by the **DIAL** knob.

The procedure for enabling the Band-Edge Beeper is:

1. Press and hold in the **[TXPO]** key for one second to enter the Set mode.
2. Rotate the **DIAL** knob to select Set Mode Item 12: BP EDG.
Note: Do not forget to pull the **DIAL** knob to rotate the **DIAL** knob.
3. Press the **[TXPO]** key momentarily to enable adjustment of this Set Mode Item.
4. Rotate the **DIAL** knob to set this Set Mode Item to “ON.”
5. When you have made your selection, press the **PTT** switch to save the setting and exit to normal operation.

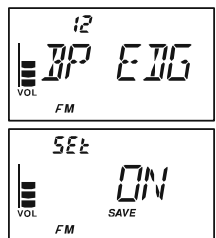

SMART SEARCH OPERATION

The Smart Search feature allows you to load frequencies automatically where activity is encountered by your radio. When Smart Search is engaged, the transceiver will search above and below your current frequency, storing active frequencies as it goes (without stopping on them even momentarily). These frequencies are stored into a special Smart Search memory bank, consisting of 31 memories (15 above the current frequency, 15 below the current frequency, plus the current frequency itself).

Two basic operating modes for Smart Search are available:

SINGLE: In this mode, the transceiver will sweep the current band once in each direction starting on the current frequency. All channels where activity is present will be loaded into the Smart Search memories, whether or not all 31 memories are filled. The search will stop after one sweep in each direction.

CONT: In this mode, the transceiver will make one pass in each direction as with One-Shot searching. However, if all 31 channels are not filled after the first sweep, the radio will continue sweeping until they are all filled.

SETTING THE SMART SEARCH MODE

1. Press and hold in the [TXPO] key for one second to enter the Set mode.
2. Rotate the **DIAL** knob to select Set Mode Item 71: S SRCH.
Note: Do not forget to pull the **DIAL** knob to rotate the **DIAL** knob.
3. Press the [TXPO] key momentarily to enable adjustment of this Set Mode Item.
4. Rotate the **DIAL** knob to select the desired Smart Search mode (see above).
5. When you have made your selection, press the **PTT** switch to save the setting and exit to normal operation.

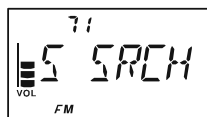

SMART SEARCH OPERATION

STORING SMART SEARCH MEMORIES

1. Set the radio to the VFO mode. Be sure that you have the Squelch adjusted properly (so that band noise is quieted).
2. Rotate the **DIAL**, while pressing and holding in the **[MODE]** key, to select the “S SRCH (Smart Search) Mode.”

Note: Do not forget to pull the **DIAL** knob to rotate the **DIAL** knob.

3. Release the **[MODE]** key to enter the Smart Search mode.
4. Press and hold the **[BAND]** key for one second to begin the Smart Search scanning.
5. As active channels are detected, you will observe the number of “loaded” channels increasing in the regular memory channel window.
6. Depending on the mode you set for Smart Search operation (“SINGLE” or “CONT”), the Smart Search scan will eventually terminate, and the LCD will revert to Smart Search Memory Channel “C.”
7. To recall the Smart Search memories, rotate the **DIAL** knob to choose from among the Smart Search memories.
8. To return to normal operation, just press the **[MODE]** key.

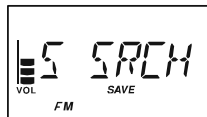
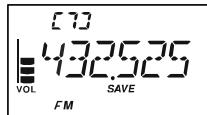

Smart Search is a great tool when visiting a city for the first time. You don't need to spend hours looking up repeater frequencies from a reference guidebook...just ask your VX-3R/E where the action is!

CHANNEL COUNTER OPERATION

The Channel Counter allows measuring of the frequency of a nearby transmitter, without knowing that frequency in advance. The frequency can be measured by bringing the **VX-3R/E** close to the transceiver which is transmitting.

The **VX-3R/E** performs a high-speed search within a ± 5 MHz range from the frequency displayed on the LCD. When the strongest signal in that range is identified, the **VX-3R/E** displays the frequency of that (strongest) signal, and writes it into the special “Channel Counter” memory.

Note: This Channel Counter is designed to provide an indication of the operating frequency of the incoming signal, one that is close enough to allow the user, thereafter, to tune precisely to the other station’s frequency. This feature is not, however, designed to provide a precise determination of the other station’s frequency.

1. Set the radio to the VFO mode in the predicted frequency range for the transmitter to be measured.
2. Bring the **VX-3R/E** into close proximity to the transmitter to be measured.
3. Rotate the **DIAL**, while pressing and holding in the **[MODE]** key, to select the “CH CNT (Channel Counter) mode.”



3. Rotate the **DIAL**, while pressing and holding in the **[MODE]** key, to select the “CH CNT (Channel Counter) mode.”



Note: Do not forget to pull the **DIAL** knob to rotate the **DIAL** knob.

4. Release the **[MODE]** key to begin the Channel Counter; the frequency of the nearby station will be displayed. When the channel counter is active, a 50 dB receiver front-end attenuator will be engaged. Therefore, only stations in close proximity may have their frequencies measured using this feature.



5. If it isn’t possible to determine the signal’s frequency, the transceiver will return to the frequency on which you were operating when you started Channel Counter operation.
6. When you are finished, just press the **[MODE]** key. The radio will exit from Channel Counter operation.

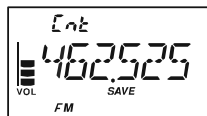

CHANNEL COUNTER OPERATION

SETTING THE CHANNEL COUNTER SWEEP WIDTH

You may change the bandwidth of the Channel Counter. Available selections are ± 5 , ± 10 , ± 50 , and ± 100 MHz (default: ± 5 MHz).

Here is the procedure for setting the Channel Counter Bandwidth:

1. Press and hold in the [TXPO] key for one second to enter the Set mode.
2. Rotate the **DIAL** knob to select Set Mode Item 17: CH CNT.

Note: Do not forget to pull the **DIAL** knob to rotate the **DIAL** knob.

3. Press the [TXPO] key momentarily to enable adjustment of this Set Mode Item.
4. Rotate the **DIAL** knob to select the desired bandwidth.
5. When you have made your selection, press the **PTT** switch to save the new setting and exit to normal operation.

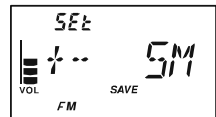

MESSAGE FEATURE

The **VX-3R/E** provides a message feature, which sends a message (up to 16 characters) instead of sending a voice. 20 different messages can be programmed, and one of them can be selected and transmitted with your ID.

Note

- ❑ The Message Feature requires that all members (1) use the **VX-3R/E**, **VX-8R/DR/E/DE**, **VX-8GR/GE**, or Vertex Standard **FTM-10R/RS/E/SE** transceiver, (2) store the same messages into the message slot, (3) store the same member list into the member box, and (4) set the same frequency.
- ❑ Does not send the Message through the repeater.

PROGRAMMING A MESSAGE

(Requires all members set the same message into the same message slot in the same order.)

The **VX-3R/E** has 20 message slots, including a factory-programmed message (EMERGENCY). The factory-programmed message of course can be overwritten at any time with personalized messages.

1. Press and hold in the [TXPO] key for one second to enter the Set mode.

2. Rotate the **DIAL** knob to select Set Mode Item 57: MSG.SEL.

Note: Do not forget to pull the **DIAL** knob to rotate the **DIAL** knob.

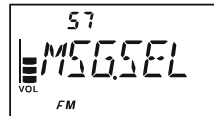

3. Press the [TXPO] key momentarily to enable adjustment of this Set Mode Item.

4. Rotate the **DIAL** knob to select the desired Message slot into which you wish to store a message. The LCD displays the previously stored message.



5. Press the [V/M] key momentarily to enable programming of the message.

6. Press and hold in the [HM/RV] key for one second to clear the previously stored message, if desired.

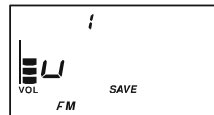

7. Rotate the **DIAL** knob to select the first character of the message you wish to store, and then press the [V/M] key to save the first character of the message and move on to the next place.

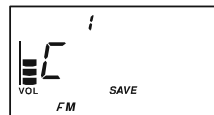

8. Repeat the previous step to complete the message (up to 16 characters). If you make a mistake, press the [BAND] key to move back to the incorrect character, then re-enter the correct character.

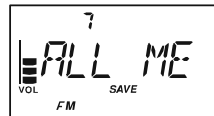

9. Press and hold in the [HM/RV] key for one second to delete all data after the cursor that may have been previously stored erroneously.

10. When the Message entry is complete, press the [TXPO] key momentarily.

11. If you wish to store another message, repeat steps 3 through 10 above.

12. Press the **PTT** switch to exit to normal operation.

PROGRAMMING A MEMBER LIST

(Requires all members set the same member list (includes own ID) into the same member box in the same order.)

It is possible to register a maximum of 20 persons, in order to identify the sender. When you receive a message transfer, you can know who sent the message by the ID in the register. In addition, your ID can be sent to the members when you transmit any messages to them.

If all the members share the register information (ID), the message sender ID will be shown on the display when receiving the message.

Even if no IDs are registered, the message function can work. However, in this case, “MEMBER 1” though “MEMBER20” will be displayed when receiving a a message.

We recommend that you use your call sign for the member list.

1. Press and hold in the [TXPO] key for one second to enter the Set mode.

2. Rotate the **DIAL** knob to select Set Mode Item 55: MSG.LST.

Note: Do not forget to pull the **DIAL** knob to rotate the **DIAL** knob.

3. Press the [TXPO] key momentarily to enable adjustment of this Set Mode Item.

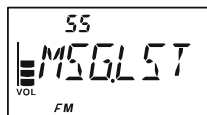

4. Rotate the **DIAL** knob to select the desired member box (01 ~ 20) into which you wish to store a member ID. The LCD will display the previously stored personal ID.

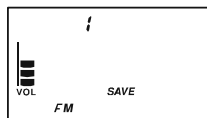

5. Press the [TXPO] key momentarily to enable programming of the personal ID.



6. Press and hold in the [HM/RV] key for one second to clear the previously stored personal ID, if desired.

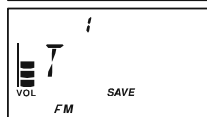

7. Rotate the **DIAL** knob to select the first character of the personal ID you wish to store, and then press the [V/M] key to save the first character of the personal ID and move on to the next place.

8. Repeat previous step to complete the personal ID (up to 8 characters). If you make a mistake, press the [BAND] key to move back to the incorrect character, then re-enter the correct character.



9. Press and hold in the [HM/RV] key for one second to delete all data after the cursor that may have been previously stored erroneously.

10. When the personal ID entry is complete, press the [TXPO] key momentarily.

11. If you wish to store another personal ID, repeat steps 3 through 10 above.

12. Press the **PTT** switch to exit to normal operation.

MESSAGE FEATURE

SET YOUR PERSONAL ID

You choose your personal ID from the member list.

1. Press and hold in the [TXPO] key for one second to enter the Set mode.
2. Rotate the **DIAL** knob to select Set Mode Item 56: MSG.REG.
Note: Do not forget to pull the **DIAL** knob to rotate the **DIAL** knob.
3. Press the [TXPO] key momentarily to enable adjustment of this Set Mode Item.
4. Rotate the **DIAL** knob to select the member box (1 ~ 20) where your ID is stored.
5. Press the **PTT** switch to save the new setting and exit to normal operation.



SENDING A MESSAGES

The registered message can be sent to the members who are receiving the coordination frequency. When a message is sent, the transmitter's ID will be sent also, and the receiver can identify who sent the message.

The "Personal ID" setting (described previous paragraph) is required for the transmitter's ID to be shown with the received message.

1. Set the radio to the coordination frequency.
2. Press and hold in the [TXPO] key for one second to enter the Set mode.
3. Rotate the **DIAL** knob to select Set Mode Item 79: SQ TYP.
Note: Do not forget to pull the **DIAL** knob to rotate the **DIAL** knob.
4. Press the [TXPO] key momentarily to enable adjustment of this Set Mode Item.
5. Rotate the **DIAL** knob to select "MESSAGE" (to activate the Message feature).
6. Press the [TXPO] key momentarily, then rotate the **DIAL** knob to select Set Mode Item 57: MEG.SEL.
7. Press the [TXPO] key momentarily to enable adjustment of this Set Mode Item.
8. Rotate the **DIAL** to select the message you wish to send.
9. Press the PTT switch to exit from the Set Mode and activates the Message feature.
10. When the Message feature is activated, the "M" notation will appear at the 100 MHz digit of the frequency.
11. Press the **PTT** switch again (without speaking into the microphone) to transmit the selected message on the coordination frequency. It takes approximately 6 seconds to transmit the message.

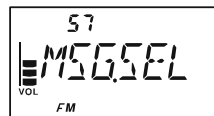

RECEIVING A MESSAGE

1. Set the radio to the coordination frequency.
2. Press and hold in the [TXPO] key for one second to enter the Set mode.
3. Rotate the **DIAL** knob to select Set Mode Item 79: SQ TYP.
Note: Do not forget to pull the **DIAL** knob to rotate the **DIAL** knob.
4. Press the [TXPO] key momentarily to enable adjustment of this Set Mode Item.
5. Rotate the **DIAL** knob to select “MESSAGE” (to activate the Message feature).
6. Press the **PTT** switch to exit from the Set Mode and activates the Message feature.
7. When you receive a message: a beep sounds, the **TX/BUSY** indicator blinks white, and [“Message” FROM “sending station’s ID”] scrolls on the display.
8. Press any key (except [VOL] key) to clear the received message, and wait for a new message.

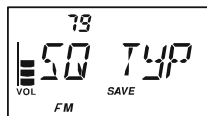

To disable the Message feature, repeat the above procedure, rotating the **DIAL** knob to select “OFF” in step 5 above.



If you enable the CTCSS/DCS/EPCS Bell feature (described previously), you can confirm that a message is coming in by a ringing “bell” sound alert.

EMERGENCY FEATURE

EMERGENCY CHANNEL OPERATION

The **VX-3R/E** includes an “Emergency” feature, which may be useful if you have someone monitoring on the same frequency as your transceiver’s UHF “Home” channel. See page 44 for details on setting the Home channel.

The “Emergency” feature is activated by pressing and holding in the **[HM/RV]** key for one second.

When this is done, (A) the radio is placed on the UHF amateur band Home channel, (B) it emits a loud “Alarm” sound (the volume is controlled by rotating the **DIAL** knob while pressing and holding the **[VOL]** key), (C) it flashes the **TX/BUSY** indicator in white, (D) if you press the **PTT** switch, you will disable the Emergency feature temporarily. You can then transmit on the UHF Home channel, and (E) two seconds after the **PTT** release, the Emergency feature will resume.

To disable the “Emergency” feature, press and hold the **[HM/RV]** key for one second or turn the radio Off by pressing and holding in the **POWER** switch for one second.

Use this feature if you are out for a walk and want a quick way of alerting a family member to a dangerous situation. The alarm sound may discourage an attacker and allow you to escape.



- 1) Be sure to arrange with a friend or family member to be monitoring on the same frequency, as there will be no identification sent via the Emergency alarm sound. And do not transmit the alarm tone except in a true emergency!*
- 2) The TX/BUSY indicator may be changed to another function via Set Mode Item 32: **EMGSEL**; see page 112.*

EMERGENCY AUTOMATIC ID (EAI) FEATURE

The Emergency Automatic ID (EAI) feature can be used to aid in searching for persons who are incapacitated in disasters like earthquakes, especially search-and-rescue personnel who may have become injured in a debris field. When using the EAI feature, a searcher transmits a unique command (CTCSS tone pair), which will automatically cause the injured party's radio to transmit, so others may perform direction-finding and effect a rescue. The incapacitated party may not be able to speak or even press the **PTT** switch. The callsign of the incapacitated person may also be transmitted, to assist the rescue team.

If an emergency group is working in a dangerous area, all members should engage the EAI feature on their transceivers, so that others can assist a fallen team member, if necessary.

The Emergency Automatic ID (EAI) Feature has two operating modes: (1) Interval mode and (2) Continuous mode.

In the Interval mode (when the **VX-3R/E** receives the CTCSS tone pair), the radio will transmit a loud (0.5 second) beep every 2.5 seconds until the EAI timer expires.

In the continuous mode, the radio will automatically transmit a continuous signal (with maximum microphone gain), until the EAI timer expires.

The EIA is activated when the CTCSS tone pair stored in the Receiving Pager Code Memory (configured via Set Mode Item 61: PAG.CDR) is received for 5 seconds on the frequency, which is stored in Memory Channel "EAI". It is NOT necessary for the incapacitated person to press the **PTT** switch.

A call sign may be stored in the radio and the CW identifier enabled via Set Mode Item 21: CW ID. Then, when the EAI feature is activated in the Interval mode, the radio will transmit the callsign once each minute. In addition, the bright LED will blink the call sign in Morse code. The "callsign" ID can be changed to any desired sequence up to 16 characters, such as a name. The radio will transmit a loud (0.5 second) beep every 2.5 seconds, and send the call sign each minute, until the EAI timer expires.

The Emergency Automatic ID (EAI) Feature requires that you:

- (1) Store the CTCSS Tone Pair into the Receiving Pager Memory (see page 34 for the procedure),
- (2) Store the desired UHF coordination frequency into Memory Channel "EAI" (see page 42 for procedure). (We suggest using a frequency different from your normal operating channel.)
- (3) Activate the EAI function "Set Mode Item 30: EIA" to "ON".

The **VX-3R/E** radio may now be used normally. The EIA function will monitor the EIA memory channel in the background, and it will be activated when the Pager Memory Tone Pair is received on the EIA memory channel.

EMERGENCY FEATURE

EMERGENCY AUTOMATIC ID (EAI) FEATURE

Selecting the EAI mode and its Transmit Time

1. Press and hold in the [TXPO] key for one second to enter the Set mode.
2. Rotate the **DIAL** knob to select Set Mode Item 31: EAI.TMR.
Note: Do not forget to pull the **DIAL** knob to rotate the **DIAL** knob.
3. Press the [TXPO] key momentarily to enable adjustment of this Set Mode Item.
4. Rotate the **DIAL** knob to select the desired EAI mode (Interval EAI “INT” or Continuous EAI “CON”) and transmit time (1-10, 15, 20, 30, 40, and 50 minutes).
5. Press the **PTT** switch to save the new setting and exit to normal operation.



ACTIVATING THE EAI FEATURE

1. Press and hold in the [TXPO] key for one second to enter the Set mode.
2. Rotate the **DIAL** knob to select Set Mode Item 30: EAI.
Note: Do not forget to pull the **DIAL** knob to rotate the **DIAL** knob.
3. Press the [TXPO] key momentarily to enable adjustment of this Set Mode Item.
4. Rotate the **DIAL** knob to select “ON” (thus activating the EAI feature).
5. Press the **PTT** switch to save the new setting and exit to normal operation (with EAI feature “ON”).



When the EAI feature is activated, the “EAI” notation and the Band Number (or memory channel number) will appear alternately in the Memory Channel Number Display Slot of the display.









To disable the EAI feature, just repeat above procedure, rotating the **DIAL** knob to select “OFF” in step “4” above.



The VX-3R/E will ignore the EAI feature when the (1) the squelch is open, (2) there is an incoming signal on the operating frequency, (3) the operating frequency is the same as the frequency which is stored in the Memory Channel “EAI,” or (4) a VHF frequency is stored in Memory Channel “EAI.”

EMERGENCY AUTOMATIC ID (EAI) FEATURE

TO LOCATE AN UNRESPONSIVE OPERATOR USING THE EAI FEATURE

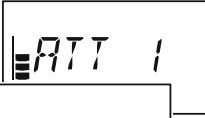
- Recall the Memory Channel “EAI” (must be the same as the searched person’s radio), which is found at the end of the “regular” memory channel.
- Set the Transmitting Pager Code Memory tone pair to the same CTCSS tone pair stored in the Receiving Pager Code Memory of the missing person’s radio.
 - Press and hold in the [TXPO] key for one second to enter the Set mode.
 - Rotate the **DIAL** knob to select Set Mode Item 62: PAG.CDT.
Note: Do not forget to pull the **DIAL** knob to rotate the **DIAL** knob
 - Press the [TXPO] key to enable adjustment of this Set Mode Item.
 - Rotate the **DIAL** knob to select the first tone.
 - Press the [V/M] key.
 - Rotate the **DIAL** knob to select the second tone.
 - Press the **PTT** switch to save the new setting and exit from setting mode.
- Press and hold in the **PTT** switch for five seconds. If the EAI signal is received by a **VX-3R/E** transceiver programmed with matching CTCSS Receiving Pager Code, the EAI feature will activate. The lost operator’s radio will transmit in accordance with the setting of Set Mode Item 31: EAI TIME (For example, *in the Interval mode*, the radio will transmit a loud (0.5 second) beep every 2.5 seconds until the EAI timer expires. *In the continuous mode*, the radio will automatically transmit continuously with maximum microphone gain). You may now begin direction-finding efforts.
- The ATT (Front End Attenuator) is often useful in locating the missing person's radio, as peaks in weaker signals are more easily observed. You may select the ATT level “ATT 1 (10 dB),” “ATT 2 (50 dB),” and “ATT OFF” by pressing the [BAND] key to reduce the signal.
- Press the [V/M] key to exit to normal operation.

ARTS™ (AUTOMATIC RANGE TRANSPONDER SYSTEM)

The ARTS™ feature uses DCS signaling to inform both parties when you and another ARTS™-equipped station are within communications range. This may be particularly useful during Search-and Rescue situations, where it is important to stay in contact with other members of your group.

Both stations must set up their DCS codes to the same code number, then activate their ARTS™ feature using the command appropriate for their radio. Alert ringers may be activated, if desired.

Whenever you push the **PTT** switch, or every 25 (or 15) seconds after ARTS™ is activated, your radio will transmit a signal which includes a (subaudible) DCS signal for about 1 second. If the other radio is in range, the beeper will sound (if enabled) and the display will show “IN RNG” as opposed to the out of range display “OUT RNG” in which ARTS™ operation begins.

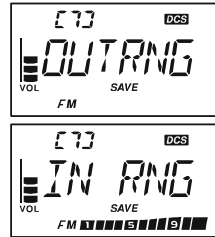

Whether you talk or not, the polling every 15 or 25 seconds will continue until you de-activate ARTS™. You can program your radio to transmit your callsign every 10 minutes, via CW, to comply with identification requirements. When ARTS™ is de-activated, DCS will also be deactivated (if you were not using it previously in non-ARTS™ operation).

If you move out of range for more than one minute (four pollings), your radio will sense that no signal has been received, three beeps will sound, and the display will revert to “OUT RNG.” If you move back into range, your radio will again beep, and the display will change back to the “IN RNG” indication.

During ARTS™ operation, your operating frequency will continue to be displayed, but no changes may be made to it or other settings; you must terminate ARTS™ in order to resume normal operation. This is a safety feature designed to prevent accidental loss of contact due to channel change, etc.

ARTS™ (AUTOMATIC RANGE TRANSPONDER SYSTEM)

BASIC ARTS™ SETUP AND OPERATION

1. Set both radios to the same DCS code number, per the discussion on page 30.
2. Press and hold in the [⊗] key for one second. You will observe the “OUT RNG” display on the LCD below the operating frequency. ARTS™ operation has now commenced.
3. Every 25 seconds, your radio will transmit a “polling” call to the other station. When that station responds with its own ARTS™ polling signal, the display will change to “IN RNG” to confirm that the other station’s polling code was received in response to yours.
4. Press and hold in the [⊗] key for one second to exit ARTS™ operation and resume normal functioning of the transceiver.

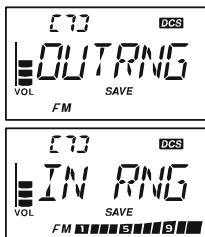

ARTS™ POLLING TIME OPTIONS

The ARTS™ feature may be programmed to poll every 25 seconds (default value) or 15 seconds. The default value provides maximum battery conservation, because the polling signal is sent out less frequently. To change the polling interval:

1. Press and hold in the [TXPO] key for one second to enter the Set mode.
2. Rotate the **DIAL** knob to select Set Mode Item 7: ARTSIT.
Note: Do not forget to pull the **DIAL** knob to rotate the **DIAL** knob.
3. Press the [TXPO] key momentarily to enable adjustment of this Set Mode Item.
4. Rotate the **DIAL** knob to select the desired polling interval (15 or 25 seconds).
5. When you have made your selection, press the **PTT** switch to save the new setting and exit to normal operation.

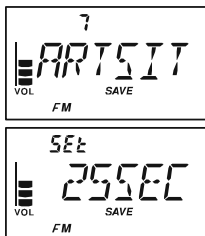

ARTS™ (AUTOMATIC RANGE TRANSPONDER SYSTEM)

ARTS™ ALERT BEEP OPTIONS

The ARTS™ feature allows two kinds of alert beeps (or off), to alert you to the status of ARTS™ operation. Depending on your location and the potential annoyance associated with frequent beeps, you may choose the Beep mode which best suits your needs. The choices are:

IN RANG: The beeps are issued only when the radio first confirms that you are within range, but does not re-confirm with beeps thereafter.

ALWAYS: Every time a polling transmission is received from the other station, the alert beeps will be heard.

OFF: No alert beeps will be heard. You must look at the display to confirm current ARTS™ status.

To set the ARTS™ Beep mode, use the following procedure:

1. Press and hold in the [TXPO] key for one second to enter the Set mode.
2. Rotate the **DIAL** knob to select Set Mode Item 6: ARTSBP.

Note: Do not forget to pull the **DIAL** knob to rotate the **DIAL** knob.

3. Press the [TXPO] key momentarily to enable adjustment of this Set Mode Item.
4. Rotate the **DIAL** knob to select the desired ARTS™ Beep mode (see above).
5. When you have made your selection, press the **PTT** switch to save the new setting and exit to normal operation.

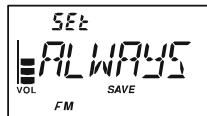
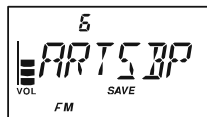

CW IDENTIFIER SETUP

The ARTS™ feature includes a CW identifier, as discussed previously. Every ten minutes during ARTS™ operation, the radio can be enabled to send “DE (your callsign) K”. The callsign field may contain up to 16 characters.

Here’s how to program the CW Identifier:

1. Press and hold in the [TXPO] key for one second to enter the Set mode.
2. Rotate the **DIAL** knob to select Set Mode Item 19: CW ID.
Note: Do not forget to pull the **DIAL** knob to rotate the **DIAL** knob.
3. Press the [TXPO] key momentarily to enable adjustment of this Set Mode Item.
4. Rotate the **DIAL** knob to set this Item to “ON” (to enable the CW ID function).
5. Press the [V/M] key momentarily to display any previously-stored callsign.
6. Press and hold the [HM/RV] key for 2 seconds to *clear* any previous callsign.
7. Rotate the **DIAL** knob to select the first letter/number of your callsign, then press the [V/M] key momentarily to save the first letter/number and move on to the next character.
8. Repeat the previous step, as many times as necessary, to complete your callsign. Note that the “slant bar” (—••—•) is among the available characters, should you be a “portable” station.
9. If you make a mistake, press the [BAND] key to backspace the cursor, then re-enter the correct letter/number.
10. Press and hold the [HM/RV] key for 2 seconds to delete all data after the cursor that may have been previously stored erroneously.
11. When you have entered your entire callsign, press the [TXPO] key momentarily to confirm the callsign, then press the **PTT** switch to save the settings and exit to normal operation.

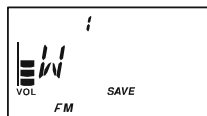
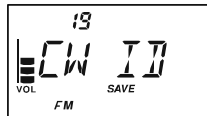



1) You may check your work by monitoring the entered callsign. To do this, repeat steps 1- 3 above, then press the [F/W] key.

2) You may adjust the monitoring tone (CW sidetone pitch) via Set Mode Item 21: CW PIT. Available selections are 400 - 1000 Hz (50 Hz/step).

INTERNET CONNECTION FEATURE

The **VX-3R/E** can be used to access a “node” (repeater or base station) which is tied into the Vertex Standard WIRES™ (Wide-Coverage Internet Repeater Enhancement System) network, operating in the “SRG” (Sister Radio Group) mode. Details may be found at the WIRES-II Web site: <http://www.yaesu.com/jp/en/wiresinfo-en/index.html>. This feature may also be used to access other systems, as described below.

SRG (“SISTER RADIO GROUP”) MODE

1. Press the [☒] key to activate the Internet Connection feature. The “☒” icon will appear in the upper right corner of the display.
2. Rotate the **DIAL** knob, while pressing and holding in the [☒] key, to select the access number (“DTMF 0” - “DTMF 9”, “DTMF A”, “DTMF B”, “DTMF C”, “DTMF D”, “DTMF E (*), “DTMF F (#)”) corresponding to the WIRES™ repeater to which you wish to establish an Internet link (ask your repeater owner/operator if you don’t know the access numbers in the network). Now press the **PTT** switch to exit from the selection mode.

Note: Do not forget to pull the **DIAL** knob to rotate the **DIAL** knob.

3. With the Internet Connection feature activated (as in step 1 above), the **VX-3R/E** will generate a brief (0.1 second) DTMF tone according to your selection in step 2. This DTMF tone is sent at the beginning of every transmission to establish or maintain the link to the remote WIRES™ repeater operating in the SRG mode.
4. To disable the Internet Connection feature, press the [☒] key again (The “☒” icon disappear from the display).



If other users report that you always have a DTMF “beep” at the beginning of each transmission, and you are not operating in conjunction with Internet access, disable this function via step 4 above.

INTERNET CONNECTION FEATURE

FRG (“FRIENDLY RADIO GROUP”) MODE

You may access other Internet Link Systems (including WIRES™ in the FRG mode) that use a DTMF string for access.

PROGRAMMING THE FRG CODE

Load the DTMF tones which you wish to use for Internet-link access into an Internet Memory Register. For purposes of this example, we will use “#(F)1101D” as the access code (the “#” key is denoted by the letter “F”).

1. Press and hold in the [TXPO] key for one second to enter the Set mode.
2. Rotate the **DIAL** knob to select Set Mode Item 41: INT.SEL.
Note: Do not forget to pull the **DIAL** knob to rotate the **DIAL** knob.
3. Press the [TXPO] key to enable adjustment of this Set Mode Item.
4. Rotate the **DIAL** knob to select the DTMF Memory register (“F 0” - “F63”) into which you wish to store the access code.
5. Press the [V/M] key momentarily. The first digit will blink.
6. Rotate the **DIAL** knob to select “F” (representing DTMF “#”: the first digit of the DTMF string).
7. Press the [V/M] key momentarily to accept the first digit and move to the second digit of the DTMF string.
8. If you make a mistake, press the [BAND] key to backspace the cursor, then re-enter the correct letter or number.
9. Repeat steps 6 through 8 until you have completed the access code (“F(#)1101D”).
10. If you wish to attach an alpha/numeric name “Tag” to the Internet Memory, proceed to the next step; otherwise press the PTT switch to save the settings and exit to normal operation.
11. Press the [V/M] key twice. The DTMF Memory register number blinks.
12. Press the [MODE] key momentarily (the “-ALPHA-” notation appear in the display for 2 seconds), then press the [V/M] key momentarily to enable programming of the name tag.
13. Rotate the **DIAL** knob to select the first digit of the desired label.
14. Press the [V/M] key to move to the next character.
15. If you make a mistake, press the [BAND] key to back-space the cursor, then re-enter the correct letter, number, or symbol.
16. Repeat steps 13 through 15 to program the remaining letters, numbers, or symbols of the desired label. Six characters may be used in the creation of a label.

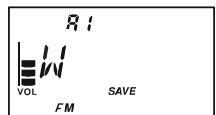
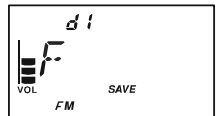
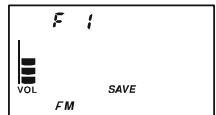

INTERNET CONNECTION FEATURE

FRG (“FRIENDLY RADIO GROUP”) MODE

- When you have programmed a label that is less than 6 characters, press the [TXPO] key to confirm the label.
- Repeat steps 3 through 17 to store other access codes, if so desired.
- Press the PTT switch to save the settings and exit to normal operation.



OPERATION (ACCESSING AN FRG NODE)

- Press and hold in the [TXPO] key for one second to enter the Set mode again.
- Rotate the DIAL knob to select Set Mode Item 39: INT MD.
Note: Do not forget to pull the DIAL knob to rotate the DIAL knob.
- Press the [TXPO] key to enable adjustment of this Set Mode Item.
- Rotate the DIAL knob to set this Set Mode Item to “FRG” (thus activating the “Other Internet Link System” mode).
- Press the PTT switch to save the new settings.
- Press the [⊗] key momentarily to activate the Internet Connection feature. The “⊗” icon will appear in the upper right corner of the display.
- Rotate the DIAL knob while pressing the [⊗] key to select the Internet Memory register number (“F 0” - “F63”) corresponding to the Internet link repeater to which you wish to establish an Internet link, then press the PTT switch momentarily to lock in the selected access number.
- Once the Internet Connection feature is activated per step 7 above, you may now press the [⊗] key, while you are transmitting, to send out the selected DTMF string (to establish the link to the desired Internet-link mode).
- To return to the WIRES™ SRG mode, repeat steps 1 - 5 above, selecting “SRG” in step 4.

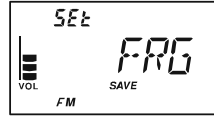

DTMF OPERATION

Despite the lack of a DTMF keypad, you can still transmit DTMF tones with the **VX-3R/E** for repeater control or autopatch use.

MANUAL DTMF TONE GENERATION

1. Press and hold the [TXPO] key for one second to enter the Set mode.
2. Rotate the **DIAL** knob to select Set Mode Item 26: DT A/M.
Note: Do not forget to pull the **DIAL** knob to rotate the **DIAL** knob.
3. Press the [TXPO] key to enable adjustment of this Set Mode Item.
4. Rotate the **DIAL** knob to select “MANUAL.”
5. Press the **PTT** switch to return to normal display.
6. Hold the **PTT** switch in to continue transmitting during the following steps.
 - A. Press the [TXPO] key momentarily.
 - B. Rotate the **DIAL** knob to select the number to be sent, and then press the [TXPO] key momentarily to send the number.
 - C. Repeat step B as many times as needed until you have completed the number string.
 - D. Release the **PTT** switch.



The DTMF “” code is displayed as “E,” and the DTMF code “#” is displayed as “F” on the display.*

DTMF AUTODIALER

10 DTMF Autodial memories are provided, allowing you to store telephone numbers for autopatch use. You can also store short autopatch or Internet-link access code streams to avoid having to send them manually.

Here is the DTMF Autodial storage procedure:

1. Press and hold in the [TXPO] key for one second to enter the Set mode.
2. Rotate the **DIAL** knob to select Set Mode Item 28: DT SEL.
Note: Do not forget to pull the **DIAL** knob to rotate the **DIAL** knob.
3. Press the [TXPO] key to enable adjustment of this Set Mode Item.
4. Rotate the **DIAL** knob to select the DTMF Memory register (“CH0” - “CH9”) into which you wish to store this DTMF string.
5. Press the [V/M] key to begin DTMF Memory entry into the selected register. The first digit location will blink.
6. Press and hold the [HM/RV] key for 2 seconds to *clear* any pre-

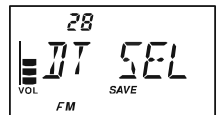

DTMF OPERATION

DTMF AUTODIALER

vious stored telephone number, if desired.

7. Rotate the **DIAL** knob to select the first digit of the DTMF string. Selectable entries are 1 - 9, and A - F, with E and F representing DTMF “*” and “#” tones respectively.
8. Press the [**VM**] key momentarily to accept the first digit and move on to the second digit of the DTMF string.
9. Repeat the previous steps until you have completed the telephone number string.
10. If you make a mistake, press the [**BAND**] key to backspace the cursor, then re-enter the correct digit.
11. Press and hold in the [**HM/RV**] key for one second to delete all data after the cursor that may have been previously stored erroneously.
12. Press the [**TXPO**] key momentarily to store the string into the DTMF memory.
13. To store another number, press the [**TXPO**] key again, then rotate the **DIAL** knob to select another DTMF Memory register, and repeat this procedure.
Press the [**F/W**] key to check (monitoring) the entered telephone number.
14. When finished storing DTMF Memories, press the **PTT** switch to return to normal display.



To send the telephone number:

1. Press and hold in the [**TXPO**] key for one second to enter the Set mode.

2. Rotate the **DIAL** knob to select Set Mode Item 26: DT A/M.

Note: Do not forget to pull the **DIAL** knob to rotate the **DIAL** knob.

3. Press the [**TXPO**] key to enable adjustment of this Set Mode Item.
4. Rotate the **DIAL** knob to set this Item to “AUTO.”
5. Press the **PTT** switch to return to normal display.
6. Hold the **PTT** switch to continue transmitting during following steps.
 - A. Press the [**TXPO**] key momentarily.
 - B. Rotate the **DIAL** knob to select the DTMF Memory register (CH 0 through CH 9) you wish to send.
 - C. Press the [**TXPO**] key momentarily to transmit the tone string. Once the string begins, you may release the **PTT** switch, as the transmitter will be held “on the air” until the DTMF string is completed.



DTMF AUTODIALER

The speed at which the DTMF digits are sent can be changed. Two speed levels are available: Low (10 digits per second) and High (20 digits per second: default). To toggle between Low and High speed, use the following procedure:

1. Press and hold the [TXPO] key for one second to enter the Set mode.
2. Rotate the **DIAL** knob to select Set Mode Item 29: DT SPD.
Note: Do not forget to pull the **DIAL** knob to rotate the **DIAL** knob.
3. Press the [TXPO] key to enable adjustment of this Set Mode Item.
4. Rotate the **DIAL** knob to select the desired speed (“50MS”: High speed or “100 MS”: Low speed).
5. Press the **PTT** switch to save the new setting and exit to normal operation.



You can also set a longer delay between the time your transmitter is keyed and the first DTMF digit is sent. To set the delay time, use the following procedure:

1. Press and hold the [TXPO] key for one second to enter the Set mode.
2. Rotate the **DIAL** knob to select Set Mode Item 27: DT DLY.
Note: Do not forget to pull the **DIAL** knob to rotate the **DIAL** knob.
3. Press the [TXPO] key to enable adjustment of this Set Mode Item.
4. Rotate the **DIAL** knob to select the desired delay (50/250/450/750/1000MS).
5. Press the **PTT** switch to save the new setting and exit to normal operation.

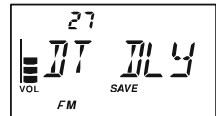

CW LEARNING FEATURE

The **VX-3R/E** provides a CW learning function, which sends the designated Morse Code via the sidetone (heard in the speaker) to help your CW learning.

1. Press and hold in the [TXPO] key for one second to enter the Set mode.

2. Rotate the **DIAL** knob to select Set Mode Item 20: CWLRNG.

Note: Do not forget to pull the **DIAL** knob to rotate the **DIAL** knob.



3. Press the [TXPO] key momentarily to enable adjustment of this Set Mode Item.

4. Press the [MODE] key to select the Training mode (displayed in fine print at the upper edge of the LCD):

A: Sends the Alphabet characters

A_r: Sends the Alphabet characters (move to next character automatically)

n: Sends the Numeric characters

n_r: Sends the Numeric characters (move to next character automatically)

S: Sends the Symbol characters

S_r: Sends the Symbol characters (move to next character automatically)



5. Rotate the **DIAL** knob to select the Morse speed. You may select the units of the code speed between “CPM (characters per minute)” and “WPM (Words per minute)” by pressing the [V/M] key.

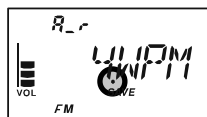

6. Press the [BAND] key to switch the flashing of the LED (white) on and off; a “dot” by the CW speed indicates that the LED is on.

7. Press the [HM/RV] key to change the display on the right. Rotate the **DIAL** knob to select the CW code which you want to learn and press the [V/M] key select the repetition time (1 - 9) of the sending.

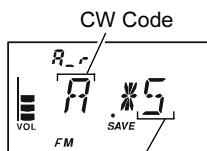

8. Press the [F/W] key to begin generating the selected code characters the designated number of times (Only the speaker CW sidetone is heard, the radio does not transmit).

Repetition Time

9. If one of the “r” modes is selected in step 4 above, you may change the direction of the character rotation by tuning the **DIAL** knob.

10. You may adjust the CW sidetone audio level by rotating the **DIAL** knob while pressing and holding the [VOL] key.

11. If one of the “r” modes is not selected in step 4 above, press the [F/W] key to send again, or select another code by rotating the **DIAL** knob and press the [F/W] key to begin generation.

If one of the “r” modes is selected in step 4 above, press the [F/W] key to stop the CW generation.

12. To stop the CW generation, press the [F/W] key again.

13. To disable the CW learning feature, press the **PTT** switch.

CW LEARNING FEATURE



1) The “CPM” selection is based on the international “PARIS” standard, which stipulates five characters per word.

2) You may adjust the CW sidetone pitch via Set Mode Item 21: CWPTCH. Available selections are 400 - 1000 Hz (50 Hz/step).

CW TRAINING FEATURE

The **VX-3R/E** provides another CW learning function; call it a CW Training feature, which sends random Morse Code via the sidetone (heard in the speaker), so you can improve your CW proficiency.

1. Press and hold in the **[TXPO]** key for one second to enter the Set mode.

2. Rotate the **DIAL** knob to select Set Mode Item 22: CWTRNG.

Note: Do not forget to pull the **DIAL** knob to rotate the **DIAL** knob.



3. Press the **[TXPO]** key momentarily to enable adjustment of this Set Mode Item.

4. Press the **[MODE]** key to select the Training mode (displayed in fine print at the upper edge of the LCD):

A: Sends five Alphabet characters only

A_r: Sends Alphabet characters only (Repeatedly)

n: Sends five Numeric characters only

n_r: Sends Numeric characters only (Repeatedly)

An: Sends five Alphabet, Numeric, “?,” and “/” characters (Mixed)

Anr: Sends Alphabet, Numeric, “?,” and “/” characters (Mixed, Continuously in groups of five)



5. Rotate the **DIAL** knob to select the Morse speed. You may select the units of the code speed between “CPM (characters per minute)” and “WPM (Words per minute)” by pressing the **[V/M]** key.



6. Press the **[BAND]** key to switch the flashing of the LED (white) on and off; a “dot” by the CW speed indicates that the LED is on.

7. Press the **[F/W]** key to begin generation of the code characters (CW sidetone only, the radio does not transmit); the transmitted characters will appear on the display.

If one of the “r” modes is not selected in step 4 above, press the **[F/W]** key to send another code group.



If one of the “r” modes is selected in step 4 above, press the **[F/W]** key to stop the CW generation.

8. Rotate the **DIAL** knob while press and holding the **[VOL]** key to adjust the CW sidetone outputs level.

9. Press the **PTT** switch to disable the CW Training feature and exit to normal operation.



1) *The “CPM” selection is based on the international “PARIS” standard, which stipulates five characters per word.*

2) *You may adjust the CW sidetone pitch via Set Mode Item 21: CWPTCH.*

Available selections are 400 - 1000 Hz (50 Hz/step).

PASSWORD

The **VX-3R/E** provides a password feature which can minimize the chance that your transceiver could be used by an unauthorized party.

When the password feature is activated, the radio will ask for the four digit password to be entered when the radio is first turned on. You must enter the four digit password using the **DIAL** knob and **[V/M]** key (pressing the **[V/M]** key to select the password digit and rotating the **DIAL** knob to select the password in each digit). If the wrong password is entered, the microprocessor will shut down the radio automatically.

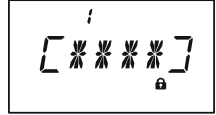

To enter the password and activating this feature, use the following procedure:

1. Press and hold in the **[TXPO]** key for one second to enter the Set mode.
2. Rotate the **DIAL** knob to select Set Mode Item 66: PSWD.
Note: Do not forget to pull the **DIAL** knob to rotate the **DIAL** knob.
3. Press the **[TXPO]** key momentarily to enable adjustment of this Set Mode Item.
4. Press the **[V/M]** key momentarily to display any previously-stored password.
5. Rotate the **DIAL** knob to select the first digit of the desired number/letter (0 - 9, A, B, C, D, E, and F).
6. Press the **[V/M]** key to move to the next digit.
7. Repeat steps 5 and 6 to program the remaining numbers/letters of the desired password.
8. If you make a mistake, press the **[BAND]** key to move back to the previous digit, then re-select the correct number/letter.
9. When you have finished entering the password, press the **[V/M]** key and rotate the **DIAL** knob to select "ON" (to activate the password feature).
10. Press the **PTT** switch to save the new setting and exit to normal operation.

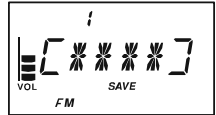

If you wish to disable the Password feature, repeat steps 1 - 3 above, then rotating the **DIAL** knob to select "OFF", then press the **PTT** switch.



- 1) *We recommend that you to write down the password number, and keep it in a safe place you can easily find if you forget your password.*
- 2) *If you forget the password number, you may turn on the transceiver by performing the "Microprocessor Resetting" procedure (see page 101). However, the VX-3R/E will clear the password, as well as all memories, and will restore all other settings to factory defaults.*

MISCELLANEOUS SETTING

PROGRAMMING THE [⊗] KEY

The Internet Key is the factory default (“primary” press key) function of the [⊗] key.

However, you may change the “primary” (press key) function of the [⊗] key to another function via the Set Mode.

1. Press and hold in the [TXPO] key for one second to enter the Set mode.
2. Rotate the **DIAL** knob to select Set Mode Item 42: INTKEY.

Note: Do not forget to pull the **DIAL** knob to rotate the **DIAL** knob.

3. Press the [TXPO] key momentarily to enable adjustment of this Set Mode Item.



4. Rotate the **DIAL** knob to select the desired function:

INTNET: Activates/Disables the internet feature.

INT MR: Recalls the Internet Access Number (SRG) or Access String (FRG). Select the SRG number or FRG string via Set Mode Item 39: INT MD.



SET MD: It is short cut path to recall one of the Set Mode Items. See below box for programming.

5. When you have made your selection, press the **PTT** switch to save the new setting and exit to normal operation.



When INT MR or SET MD is assigned to the [⊗] key, the INTNET function may be activated/disabled via Set Mode Item 43: INTNET.

ASSIGN THE SET MODE ITEM TO THE [⊗] KEY

1. Change (“primary” press key) function of the [⊗] key to “SET MD”, via Set Mode Item 42: INTKEY, as described above.
2. Press and hold in the [TXPO] key for one second to enter the Set mode again.
3. Rotate the **DIAL** knob to select the Set Mode Item which you wish to assign to the [⊗] key as a Menu short-cut.

Note: Do not forget to pull the **DIAL** knob to rotate the **DIAL** knob.

4. Press and hold in the [⊗] key for one second to assign the Set Mode Item to the [⊗] key. “MY KEY” will appear on the display, to confirm that the command was executed.

5. Press the **PTT** switch to save the new setting and exit to normal operation.

Now, momentarily pressing of the [⊗] key will immediately recall the selected Set Mode Item. You must press the [⊗] key again to exit to normal operation.

ATT (FRONT END ATTENUATOR)

The attenuator will reduce all signals (and noise) by 20 dB, and it may be used to make reception more pleasant under extremely crowded conditions.

1. Press and hold in the [TXPO] key for one second to enter the Set mode.
2. Rotate the **DIAL** knob to select Set Mode Item 3: ANT.ATT.
Note: Do not forget to pull the **DIAL** knob to rotate the **DIAL** knob.
3. Press the [TXPO] key momentarily to enable adjustment of this Set Mode Item.
4. Rotate the **DIAL** knob to change the setting from “OFF” to “ON”.
5. When you have made your selection, press the PTT switch to save the new setting and exit to normal operation.
6. If you wish to disable the attenuator, just repeat the above procedure, rotating the **DIAL** knob to select “OFF” in step “4” above.



When the attenuator is activated, the Operating Mode icon (AM or FM) will blink on the display.

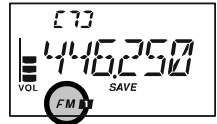

RECEIVE BATTERY SAVER SETUP

An important feature of the **VX-3R/E** is its Receive Battery Saver, which “puts the radio to sleep” for a time interval, periodically “waking it up” to check for activity. If somebody is talking on the channel, the **VX-3R/E** will remain in the “active” mode, then resume its “sleep” cycles when the signal drops. This feature significantly reduces quiescent channel battery drain. You may change the amount of “sleep” time between activity checks using the Set Mode:

1. Press and hold in the [TXPO] key for one second to enter the Set mode.
2. Rotate the **DIAL** knob to select Set Mode Item 72: SAVERX.
Note: Do not forget to pull the **DIAL** knob to rotate the **DIAL** knob.
3. Press the [TXPO] key momentarily to enable adjustment of this Set Mode Item.
4. Rotate the **DIAL** knob to select the desired “sleep” duration. The selections available are 200 - 1000 ms (100 ms/step), 1 - 10 seconds (1 sec/step), or **OFF**. The default value is 200 ms.
5. When you have made your selection, press the **PTT** switch to save the new setting and exit to normal operation.



When you are operating on Packet, switch the Receive Battery Saver OFF, as the sleep cycle may “collide” with the beginning of an incoming Packet transmission, causing your TNC not to receive the full data burst.

MISCELLANEOUS SETTING

WAKEUP FEATURE

The Wakeup feature is similar to the Receive Battery Saver. However, it is a newer, more advanced feature which conserves battery life by providing a longer “sleep” time than the regular Receive battery Saver. The Wakeup feature, once engaged, operates while the transceiver is turned off (“WAKEUP” will appear on the LCD).

To set up the Wakeup feature:

1. Press and hold in the [TXPO] key for one second to enter the Set mode.

2. Rotate the **DIAL** knob to select Set Mode Item 93: WAKEUP.



Note: Do not forget to pull the **DIAL** knob to rotate the **DIAL** knob.

3. Press the [TXPO] key momentarily to enable adjustment of this Set Mode Item.

4. Rotate the **DIAL** knob to select the desired “sleep” duration.



5 - 60SEC: (5 second/steps) Based on the selected time value, the radio will periodically check the operating frequency which it was on when the radio was turned off for activity. (That was in use when the radio was turned off.) If a signal is received on the frequency strong enough to open the Squelch, the radio will turn itself on fully. If the EAI feature was activated when the radio was turned off, the radio also checks on the EAI frequency (Memory Channel “EAI”) for activity.

EAI: Checks the EAI frequency (Memory Channel “EAI”) every 5 seconds. If a properly-coded signal is received on the EAI frequency, the radio will turn itself on and then automatically transmit in accordance with the setting of Set Mode Item 30: EAI.

OFF: Disables the Wakeup feature.

5. When you have made your selection, press the **PTT** switch to save the new setting and exit to normal operation.

If you wish to disable the Wakeup feature, just repeat the above procedure, rotating the **DIAL** knob to select “OFF” in step 4 above.

When the radio is turned off, the Wakeup feature will be engaged, and the “WAKEUP” notation will be seen on the display.



You may cancel the Wakeup feature (complete power off) temporarily by pressing the **POWER** switch while the Wakeup feature is engaged.

TX BATTERY SAVER

The **VX-3R/E** also includes a useful Transmit Battery Saver, which will automatically lower the power output level when the last signal received was very strong. For example, when you are in the immediate vicinity of a repeater station, there generally is no reason to use the High Power output in order to achieve full-quieting access to the repeater. With the Transmit Battery Saver, the automatic selection of Low Power operation conserves battery drain significantly.

To activate the Transmit Battery Saver:

1. Press and hold in the [TXPO] key for one second to enter the Set mode.
2. Rotate the **DIAL** knob to select Set Mode Item 73: SAVETX.
Note: Do not forget to pull the **DIAL** knob to rotate the **DIAL** knob.
3. Press the [TXPO] key momentarily to enable adjustment of this Set Mode Item.
4. Rotate the **DIAL** knob to set this Set Mode Item to “ON” (thus activating the Transmit Battery Saver).
5. When you have made your selection, press the **PTT** switch to save the new setting and exit to normal operation.

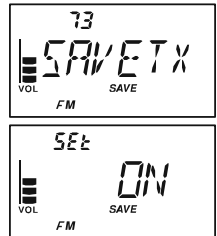

DISABLING THE BUSY INDICATOR

Further battery conservation may be accomplished by disabling the **BUSY** indicator while receiving a signal. Use the following procedure:

1. Press and hold in the [TXPO] key for one second to enter the Set mode.
2. Rotate the **DIAL** knob to select Set Mode Item 16: BSY.LED.
Note: Do not forget to pull the **DIAL** knob to rotate the **DIAL** knob.
3. Press the [TXPO] key momentarily to enable adjustment of this Set Mode Item.
4. Rotate the **DIAL** knob to set this Set Mode Item to “OFF” (thus disabling the **BUSY** lamp).
5. When you have made your selection, press the **PTT** switch to save the new setting and exit to normal operation.

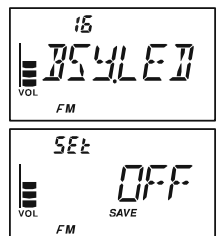

MISCELLANEOUS SETTING

AUTOMATIC POWER-OFF (APO) FEATURE

The APO feature helps conserve battery life by automatically turning the radio off when there has been no dial or key activity for a user-defined period. The available selections for the time before power-off are 0.5 - 12 hours (0.5 hour/step), as well as APO Off. The default condition of the APO is OFF. This is the procedure to activate it:

1. Press and hold in the [TXPO] key for one second to enter the Set mode.
2. Rotate the **DIAL** knob to select Set Mode Item 4: APO.

Note: Do not forget to pull the **DIAL** knob to rotate the **DIAL** knob.

3. Press the [TXPO] key momentarily to enable adjustment of this Set Mode Item.
4. Rotate the **DIAL** knob to select the desired time period after which the radio will automatically shut down.
5. When you have made your selection, press the **PTT** switch to save the new setting and exit to normal operation.



When the APO is activated, the “⓪” icon will appear at the center bottom on the LCD. If there is no action by you within the time interval programmed, a ringer sounds 3 minutes before the APO shutdown time. Three minutes thereafter, the microprocessor will shut down the radio automatically.



Just press and hold in the **POWER** switch for one second to turn the transceiver back on after an APO shutdown, as usual.

TRANSMITTER TIME-OUT TIMER (TOT)

The TOT feature provides a safety switch, which limits transmission time to a pre-programmed value. This will conserve battery power by limiting the length of transmissions. In the event of a stuck **PTT** switch (perhaps if the radio or a Speaker/Mic is wedged between car seats) it can prevent interference to other users as well as battery depletion. The TOT default is 3 minutes. To adjust the timer, follow the procedure below:

1. Press and hold in the [**TXPO**] key for one second to enter the Set mode.
2. Rotate the **DIAL** knob to select Set Mode Item 87: TOT.
Note: Do not forget to pull the **DIAL** knob to rotate the **DIAL** knob.
3. Press the [**TXPO**] key momentarily to enable adjustment of this Set Mode Item.
4. Rotate the **DIAL** knob to set the Time-Out Timer to the desired "Maximum TX" time. The available selections are 0.5 - 10 minutes (0.5 minute/step).
5. When you have made your selection, press the **PTT** switch to save the new setting and exit to normal operation.

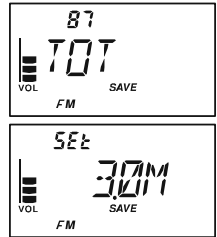

- 1) *When your transmission time is within 10 seconds of the Time-Out Timer expiration, an Alert bell will provide an audible warning from the speaker.*
- 2) *Since brief transmissions are the mark of a good operator, try setting up your radio's TOT feature for a maximum transmission time of one minute. This will significantly improve battery life, too!*

MISCELLANEOUS SETTING

AUTOMATIC POWER-ON FEATURE

The **VX-3R/E** also includes the capability to turn itself on after a programmed time interval.

1. Press and hold in the **[TXPO]** key for one second to enter the Set mode.
2. Rotate the **DIAL** knob to select Set Mode Item 58: ON TMR.
Note: Do not forget to pull the **DIAL** knob to rotate the **DIAL** knob.
3. Press the **[TXPO]** key momentarily to enable adjustment of this Set Mode Item.
4. Rotate the **DIAL** knob to set the desired time after which the radio will automatically turn on. Note: that is not the time of day when the radio will turn on; it is the number of hours and minutes until the radio turns on. The available selections are 10 minutes - 24 hours (10 minute/step).
5. When you have made your selection, press the **PTT** switch to save the new setting and exit to normal operation.

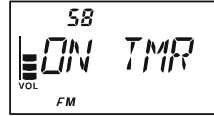

When the radio is turned off, this activates the Automatic Power-On feature; a countdown timer in the display will show the time remaining until automatic switch-on.

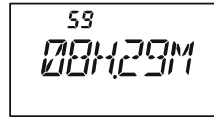

You may cancel the Automatic Power-On feature (turn off the radio), by pressing and holding the **POWER** switch for one second while the Automatic Power-On feature is engaged.

The Automatic Power-On feature will be ignored if the Wakeup feature is activated.

BUSY CHANNEL LOCK-OUT (BCLO)

The BCLO feature prevents the radio's transmitter from being activated if a signal strong enough to break through the "noise" squelch is present. On a frequency where stations using different CTCSS or DCS codes may be active, BCLO prevents you from disrupting their communications accidentally (because your radio may be muted by its own Tone Decoder). The default setting for the BCLO is OFF. This is the procedure to activate the BCLO:

1. Press and hold in the **[TXPO]** key for one second to enter the Set mode.
2. Rotate the **DIAL** knob to select Set Mode Item 8: BCLO.
Note: Do not forget to pull the **DIAL** knob to rotate the **DIAL** knob.
3. Press the **[TXPO]** key momentarily to enable adjustment of this Set Mode Item.
4. Rotate the **DIAL** knob to set this Set Mode Item to "ON" (thus activating the BCLO feature).
5. When you have made your selection, press the **PTT** switch to save the new setting and exit to normal operation.



MISCELLANEOUS SETTING

CHANGING THE TX DEVIATION LEVEL

In many areas of the world, channel congestion has required that operating channels be closely spaced. In such operating environments, it often is required that operators use reduced deviation levels, so as to reduce the potential for interference to users on adjacent channels. The **VX-3R/E** includes a simple method of accomplishing this:

1. Press and hold in the **[TXPO]** key for one second to enter the Set mode.
2. Rotate the **DIAL** knob to select the Set Mode Item 35: HLF.DEV.
Note: Do not forget to pull the **DIAL** knob to rotate the **DIAL** knob.
3. Press the **[TXPO]** key momentarily to enable adjustment of this Set Mode Item.
4. Rotate the **DIAL** knob to set this Set Mode Item to "ON." In this configuration (HALF DEVIATION active), the transmitter's deviation will be approximately ± 2.5 kHz.
5. When you have made your selection, press the **PTT** switch to save the new setting and exit to normal operation.

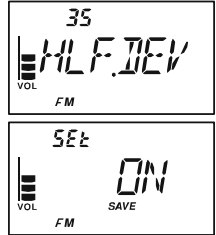

The "normal" setting for the deviation (when this Menu Item is set to "OFF") is ± 5 kHz.

CHANGING THE MICROPHONE GAIN

At the factory, a microphone gain has been programmed that should be satisfactory for the internal microphone. If you use an after-market microphone, you may wish to set a different microphone gain level.

1. Press and hold in the **[TXPO]** key for one second to enter the Set mode.
2. Rotate the **DIAL** knob to select Set Mode Item 48: MCGAIN.
Note: Do not forget to pull the **DIAL** knob to rotate the **DIAL** knob.
3. Press the **[TXPO]** key momentarily to enable adjustment of this Set Mode Item.
4. Rotate the **DIAL** knob to select the desired microphone gain.
5. When you have made your selection, press the **PTT** switch to save the new setting and exit to normal operation.

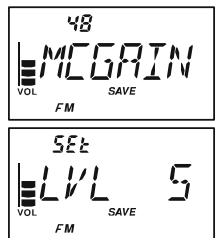

MISCELLANEOUS SETTING

MY BANDS OPERATION

The “My Bands” feature allows you to select several operating bands, and make only those bands available for selection via the [BAND] button.

For example, if you do not need the reception of the SW and Air bands, you may skip (omit) these bands from the band selection loop.

My Bands Setup

1. Set the **VX-3R/E** to the VFO mode.
2. Press and hold in the [TXPO] key for one second to enter the Set mode.
3. Rotate the **DIAL** knob to select Set Mode Item 91: VFO.SKP.
Note: Do not forget to pull the **DIAL** knob to rotate the **DIAL** knob.
4. Press the [TXPO] key momentarily to enable adjustment of this Item.
5. Rotate the **DIAL** knob to choose a band number (see chart below) you wish to omit (skip) from the band selection loop.
6. Press the [V/M] key, then rotate the **DIAL** knob to select “ON” and omit (skip) the band from the band selection loop.



7. Press the [V/M] key again.
8. Repeat steps 4 through 6 above to select as many bands as you like.
9. When you have made your selection, press the **PTT** switch to save the new setting and return to normal operation.

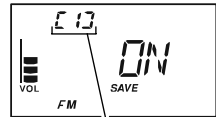

Band Number

To re-institute a band into the band selection loop, repeat the above procedure, rotating the **DIAL** knob to select “OFF” in step 5.



If you wish to skip (omit) the AM or FM Broadcast band, enter the Broadcast Reception mode by pressing the [RADIO] key momentarily at first, then perform the above procedure.

BAND NUMBER CHART

BAND NUMBER	OPERATING BAND	FREQUENCY RANGE	
		USA VERSION	EXPIEU VERSION
1	SW Band	1.8 - 30 MHz	1.8 - 30 MHz
2	50 MHz Ham Band	30 - 76 MHz	30 - 76 MHz
3	Air Band	108 - 137 MHz	108 - 137 MHz
4	144 MHz Ham Band	137 - 174 MHz	137 - 174 MHz
5	VHF-TV Band	174 - 222 MHz	174 - 222 MHz
6	Information Band 1	222 - 420 MHz	222 - 420 MHz
7	430 MHz Ham Band	420 - 470 MHz	420 - 470 MHz
8	UHF-TV Band	470 - 774 MHz	470 - 800 MHz
9	Information Band 2	803 - 999 MHz	803 - 999 MHz
A	AM Broadcast Band	510 - 1790 kHz	510 - 1790 kHz
F	FM Broadcast Band	76 - 107.9 MHz	76 - 107.9 MHz

CHANGING THE STATUS OF THE [VOL] KEY

By factory default, the [VOL] key keeps the status while pressing and holding the [VOL] key down. You may change the status of the [VOL] key to keep the status for approximately three seconds after pressing the [VOL] key, after which time it reverts back to its previous status.

1. Press and hold in the [TXPO] key for one second to enter the Set mode.
2. Rotate the **DIAL** knob to select the Set Mode Item 92: VOL MD.

Note: Do not forget to pull the **DIAL** knob to rotate the **DIAL** knob.



3. Press the [TXPO] key momentarily to enable adjustment of this Set Mode Item.
4. Rotate the **DIAL** knob to select the desired mode.

NORMAL: The [VOL] key keeps the status while pressing and holding the [VOL] key down.

AUT.BCK: The [VOL] key keeps its status for approximately three seconds after pressing the [VOL] key.



5. When you have made your selection, press the **PTT** switch to save the new setting and exit to normal operation.

CLONING

The **VX-3R/E** includes a convenient “Clone” feature, which allows the memory and configuration data from one transceiver to be transferred to another **VX-3R/E**. This can be particularly useful when configuring a number of transceivers for a public service operation. Here is the procedure for Cloning one radio’s data to another:

1. Turn both radios off.
2. Connect the optional **CT-27** Clone Cable between the **MIC/SP** jacks of the two radios.
3. Press and hold in the **[F/W]** key while turning the radios on. Do this for both radios (the order of switch-on does not matter). “CLONE” will appear on the displays of both radios when the Clone mode is successfully activated in this step.
4. On the Destination radio, press the **[V/M]** key (“- WAIT -” will appear on the LCD).
5. Press the **[BAND]** key on the Source radio; “- TX -” will appear on the Source radio, and the data from this radio will be transferred to the other radio.
6. If there is a problem during the cloning process, “ERROR” will be displayed. Check your cable connections and battery voltage, and try again.
7. If the data transfer is successful, the Destination radio returns to normal operation and “CLONE” will reappear on the Source radio.
8. Turn both radios off and disconnect the cloning cable. You can then turn the radios back on, and begin normal operation.

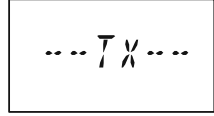
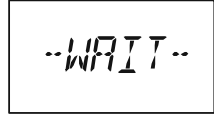

Note: Can not perform the cloning operation between the VX-3R and VX-3E.

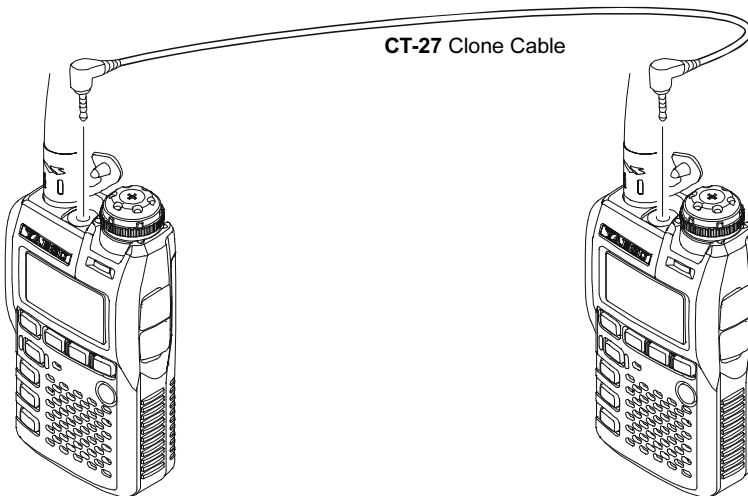

SET (MENU) MODE

The **VX-3R/E** Set Mode, already partially discussed in many previous chapters, is easy to activate and set. The Set Mode is used to configure a wide variety of transceiver parameters, some of which have not been detailed previously. Use the following procedure to activate the Set Mode and adjust the various parameters:

1. Press and hold in the **[TXPO]** key for one second to enter the Set mode.
2. Rotate the **DIAL** knob to select the Set Mode Item to be adjusted.
Note: Do not forget to pull the **DIAL** knob to rotate the **DIAL** knob.
3. Press the **[TXPO]** key momentarily to enable adjustment of the Set Mode Item.
4. Rotate the **DIAL** knob to adjust or select the parameter to be changed on the Set Mode Item selected in above step.
5. After completing your selection and adjustment, press the **PTT** switch momentarily to save the new setting and exit to normal operation.



*Some Set Mode Items (like Set Mode Item 86: TN FRQ) require that the **[TXPO]** key be pressed after setting of the parameter, and before exiting to normal operation.*

MASKING THE SET MODE ITEMS

There may be situations where you want to “Mask” Set Mode Items so they are not recalled during Set Mode Item selection.

1. Press and hold in the **[TXPO]** key for one second to enter the Set mode.
2. Rotate the **DIAL** knob to select the Set Mode Item 33: EXT.MNU.
Note: Do not forget to pull the **DIAL** knob to rotate the **DIAL** knob.
3. Press the **[TXPO]** key momentarily to enable adjustment of the Set Mode Item.
4. Rotate the **DIAL** knob to select “ON”, then press the **[TXPO]** key momentarily.
5. Rotate the **DIAL** knob to select the Set Mode Item to be “Masked”.
6. Press the **[FW]** key momentarily. A small “▶” icon will appear above the volume level indicator on the display, indicating the Set Mode Item is to be Masked.
7. Rotate the **DIAL** knob; the previously-selected Set Mode Item will be “Masked”.
8. Repeat steps 5 - 7 above, to append the “▶” icon to any other Set Mode Item you wish to “Masked”.
9. Press the **PTT** switch momentarily to save the new setting and exit to normal operation.

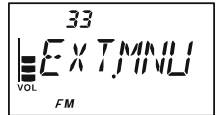

To unmask the hidden Set Mode Item, repeat the above procedure. In step 4 above select “OFF” and in step 6 above the “▶” icon will disappear from the Set Mode Item you wish to unmask.

SET (MENU) MODE

SET MODE ITEM	FUNCTION	AVAILABLE VALUES (DEFAULT: BOLD <i>ITALIC</i>)
1 [ANT AM]	Select the antenna to be used in the AM Broadcast listening.	BAREXT / BARANT
2 [ANT FM]	Select the antenna to be used in the FM Broadcast listening.	EXTANT / EARPHO
3 [ANT.ATT]	Enables/Disables the receiver Front-end Attenuator.	ON / OFF
4 [APO]	Setting of the Automatic Power-Off feature.	OFF / 0.5H - 12.0H (0.5H/steps)
5 [ARS]	Enables/Disables the Automatic Repeater Shift function.	ON / OFF
6 [ARTSBP]	Selects the Beep option during ARTS operation.	OFF / IN RNG / ALWAYS
7 [ARTSIT]	Selects the Polling Interval during ARTS operation.	15SEC / 25SEC
8 [BCLO]	Enables/Disables the Busy Channel Lock-Out feature.	ON / OFF
9 [BEL.RNG]	Selects the number of Bell ringer repetitions.	1T - 20T / CONT (Continuous ringing)
10 [BEL.SEL]	Enables/Disables the Bell ringer function and its sound selection.	OFF / BELL / USRBP1 / USRBP2 / USRBP3
11 [BNK.NAM]	Stores Alpha-Numeric "Tags" for the Memory Banks.	---
12 [BP EDG]	Enables/Disables the Band-edge beeper while selecting the frequency by the DIAL knob.	ON / OFF
13 [BP LVL]	Adjust the Beep volume level.	LVL 1 - LVL 9 (LVL 5)
14 [BP SEL]	Enables/Disables the Keypad beeper.	OFF / KY+SCN / KEY
15 [BP USR]	Create the beep melody for Bell ringer function.	---
16 [BSY.LED]	Enables/Disables the BUSY LED while the Squelch is open.	ON / OFF
17 [CH CNT]	Selects the Channel Counter Search Width.	±5 MHz / ±10 MHz / ±50 MHz / ±100 MHz
18 [CLK.SFT]	Shifting of the CPU clock frequency.	ON / OFF
19 [CW ID]	Programs and activates the CW Identifier (used during ARTS operation).	---
20 [CWL RNG]	Enables/Disables the CW Learning feature.	---
21 [CWP ICT]	Select the CW tone pitch for the CW Learn, CW training, and CW Identifier functions.	400 - 1000 Hz (50 Hz/step) (700 Hz)
22 [CWTRNG]	Enables/Disables the CW Training feature.	---
23 [DC VLT]	Indicates the DC Supply Voltage.	---
24 [DCS CD]	Setting of the DCS code.	104 standard DCS codes (023)
25 [DCS RV]	Enables/Disables the "Inverted" DCS Tone.	R-N, T-N / R-I, T-N / R-B, T-N / R-N, T-I / R-I, T-I / R-B, T-I
26 [DT A/M]	Enables/Disables the DTMF Autodial feature.	MANUAL / AUTO
27 [DT DLY]	Selects the DTMF Autodialer Delay Time.	50MS / 250MS / 450MS / 750MS / 1000MS
28 [DT SEL]	Programming of the DTMF Autodialer.	---
29 [DT SPD]	Selects the DTMF Autodialer Sending Speed.	50MS / 100MS
30 [EAI]	Enables/Disables the Emergency Automatic ID (EAI) feature.	ON / OFF
31 [EAI.TMR]	Sets the Emergency Automatic ID (EAI) operating mode and its Transmit Time.	INT. 1M through INT.10M, INT.15M, INT.20M, INT.30M, INT.40M, INT. 50M, CON. 1M through CON.10M, CON.15M, CON.20M, CON.30M, CON.40M, and CON. 50M (CON. 5M)
32 [EMG.SEL]	Select the alarms utilized when the Emergency function is engaged.	BEEP / STROBE / BP+STR / BEAM / BP+BEM / CW / BP+CW / CWT
33 [EXT.MNU]	Enables/Disables the extended Set Mode Menu.	ON / OFF
34 [FW KEY]	Set the duration that a secondary function of the [F/W] key (press and holding the [F/W] key) is held determines the function they activate.	FW0.3S / FW0.5S / FW0.7S / FW1.0S / FW1.5S
35 [HLF.DEV]	Reduce the Deviation level by 50 %.	ON / OFF
36 [HM/RV]	Selects the function of the [HM/RV] key.	HOME / REV
37 [HM>VFO]	Enables/Disables the function of the VFO DIAL knob, while in the Home Channel mode.	DISABL / ENABLE
38 [INT CD]	Selects the Access Number (DTMF digit) for the SRG operation of the Internet Connection feature (WIRES™).	DTMF 0 - DTMF F (DTMF 1)
39 [INT MD]	Selects the operating mode of the Internet Connection feature (WIRES™).	SRG / FRG
40 [INT.A/M]	Enables/Disables the DTMF Autodialer, while operating the Internet Connection feature (WIRES™).	MANUAL / AUTO
41 [INT.SEL]	Programming of the Access Number (DTMF code) for the FRG station of the WIRES™ (or non WIRES™ Internet Link System) access.	---
42 [INTKEY]	Selects the function of the [⊗] key.	INTNET / INT MR / SET MD
43 [INTNET]	Enables/Disables the Internet Connection feature (WIRES™).	ON / OFF
44 [LAMP]	Selects the LCD/Keypad Lamp mode.	KEY 2S - KEY10S / CONT / OFF (KEY 5S)
45 [LED LT]	Illuminates the TX/BUSY indicator. It will glow continuously white (useful as emergency flashlight at night).	---
46 [LOCK]	Selects the Control Locking lockout combination.	KEY / PTT / KY (KEY)+PTT
47 [M/T-CL]	Selects the function of the MONI/T.CALL key.	MONI / T-CALL (Depends on the transceiver version)
48 [MCGAIN]	Adjust the microphone gain level.	LVL 1 - LVL 9 (LVL 5)
49 [MR DSP]	Toggles the display indication between "frequency" and "Alpha-Numeric" channel tags.	ALPHA / FREQ
50 [MR WMD]	Determines the method of selecting channels for Memory Storage.	NEXT / LOWER

SET (MENU) MODE

SET MODE ITEM	FUNCTION	AVAILABLE VALUES (DEFAULT: BOLD ITALIC)
51 [MRFSTP]	Selects the channel step for the fast channel selection mode while in the Memory Recall mode.	10CH / 20CH / 50CH / 100CH
52 [MRNAME]	Stores "Alpha-Numeric" tags for the Memory channels.	---
53 [MRPCTC]	Enables/Disables the Memory Write Protector.	ON / OFF
54 [MRSKIP]	Selects the Memory Scan, channel-selection mode.	OFF / SKIP / ONLY
55 [MSG.LST]	Programming a Member List for the Message feature.	---
56 [MSG.REG]	Selects your Personal ID for the Message feature.	---
57 [MSG.SEL]	Programming a Message for the Message feature.	---
58 [ON TMR]	Set the On Timer Time.	OFF / 00H.10M(00:10) - 24H.00M(24:00) (10 minutes/step)
59 [OPN.MSG]	Selects the Opening Message that appears when the radio is powered on.	OFF / DC / MSG
60 [PAG.ABK]	Enables/Disables the Answer Back function of the Enhanced CTCSS Paging & Code Squelch.	ON / OFF
61 [PAG.CDR]	Sets the Receiver Pager Code for the Enhanced CTCSS Paging & Code Squelch.	---
62 [PAG.CDT]	Sets the Transmitting Pager Code for the Enhanced CTCSS Paging & Code Squelch.	---
63 [PR FRQ]	Program the CTCSS Tone frequency for the User programmed Reverse CTCSS Decoder.	300Hz - 3000Hz (1000 Hz/step) (1600Hz)
64 [PRI.RVT]	Enables/Disables the Priority Revert feature.	ON / OFF
65 [PRI.TMR]	Selects the time between the Priority (Dual Watch) channel checks, when the feature is active.	0.1 - 0.9S (0.1S/step) or 1.0S - 10.0S (0.5S/step) (5.0S)
66 [PSWD]	Programs and activates the Password feature.	---
67 [PTT.DLY]	Selects the time delay before the carrier is transmitted, when the PTT switch is pressed.	OFF / 20MS / 50MS / 100MS / 200MS
68 [RPT]	Sets the Repeater Shift Direction.	SIMP / -RPT / +RPT (Depends on the operating band and transceiver version)
69 [RPT.SFT]	Sets the magnitude of the repeater Shift.	0.00 - 150.00 MHz (50 kHz/step) (Depends on the operating band and transceiver version)
70 [RX MD]	Selects the Receiving mode.	AUTO / N-FM / AM / W-FM
71 [S SRCH]	Selects the Smart Search Sweep mode.	SINGLE / CONT
72 [SAVERX]	Selects the Receive-mode Battery Saver interval ("sleep" ratio)	0.2S - 0.9S (0.1S/step) or 1.0S - 10.0S (0.5S/step)
73 [SAVETX]	Enables/Disables the Transmitter Battery Saver.	ON / OFF
74 [SCN.LMP]	Enables/Disables the Scan lamp (while scanning is paused)	ON / OFF
75 [SCN.RSM]	Selects the Scan Resume mode.	2SEC - 10SEC / BUSY / HOLD (5SEC)
76 [SCN.STR]	Select the Scan Re-start Delay time.	0.1-0.4S (0.1S/step) or 1.0S - 10.0S (0.5S/step) (2.0SEC)
77 [SP OUT]	Enables/Disables the FM Broadcast audio output to the internal speaker when using the earphone antenna.	AUTO / SPKR
78 [SQ LVL]	Sets the Squelch threshold level.	LVL 0 - LVL 15 (AM and N-FM) (LVL 1), LVL 0 - LVL 8 (LVL 2) (Wide FM and AM Broadcast)
79 [SQ TYP]	Selects the Sub Audible Squelch Type.	OFF / TONE / TSQL / DCS / RV TN / PR FRQ / PAGER / MESSAGE
80 [SQSMTR]	Adjusts the Squelch threshold to the S-meter level.	OFF / LVL 1 - LVL 8
81 [SQSPLT]	Enables/Disables split CTCSS/DCS coding.	ON / OFF
82 [STEP]	Setting the Dial frequency steps.	AUTO / 5 / 8.33 / 9 / 10 / 12.5 / 15 / 20 / 25 / 50 / 100 kHz
83 [STEREO]	Enables/Disables stereo out put, while receiving the FM Broadcast band.	STEREO / MONO
84 [SUB-RX]	Sets the time before Broadcast audio is resumed after the amateur band signal drops, when the SUB-RX operation is activated.	OFF / TRX 1S - TRX 10S (1S/step) / HOLD / TX 1S - TX 10S (1S/step)
85 [TEMP]	Indicates the current temperature inside the transceiver's case and selects the measurement units ("°F" or "°C") for the temperature sensor.	---
86 [TN FRQ]	Setting of the CTCSS Tone Frequency.	50 standard CTCSS tones (100Hz)
87 [TOT]	Setting of the TOT time	OFF / 0.5M - 10.0M (0.5M/step) (3.0M)
88 [TS MUT]	Enables/Disables the receiver audio output while the Tone Search Scanner is activated.	ON / OFF
89 [TS SPD]	Selects the Tone Search Scanner speed.	SLOW (1.25 tone/sec) / FAST (2.5 tone/sec)
90 [VFO MD]	Selects or disables the VFO band edge limiting for the current band.	ALL / BAND
91 [VFO.SKP]	Set My Band.	ON / OFF
92 [VOL MD]	Select the DIAL knob function.	NORMAL / AUT.BCK
93 [WAKEUP]	Setting of the Wakeup feature.	OFF / 5SEC - 60SEC (5SEC/step) / EAI
94 [WX ALT]	Enables/Disables the NOAA Weather Alert Feature.	OFF / ON

SET (MENU) MODE

REPEATER SETTING	SET MODE ITEM	AVAILABLE VALUES (DEFAULT: BOLD ITALIC)
<input type="checkbox"/> Enables / Disables the Automatic Repeater Shift function.	5 [ARS]	ON / OFF
<input type="checkbox"/> Sets the Repeater Shift Direction.	68 [RPT]	SIMP / -RPT / +RPT
<input type="checkbox"/> Sets the magnitude of the repeater Shift.	69 [RPT.SFT]	0.00 - 150.00 MHz (50 kHz/step) (Depends on the operating band and transceiver version)
CTCSS/DCS/EPCS SETTING	SET MODE ITEM	AVAILABLE VALUES (DEFAULT: BOLD ITALIC)
<input type="checkbox"/> Selects the number of Bell ringer repetitions.	9 [BEL.RNG]	1T - 20T / CONT (Continuous ringing)
<input type="checkbox"/> Enables / Disables the Bell ringer function and its sound selection.	10 [BEL.SEL]	OFF / BELL / USRBP1 / USRBP2 / USRBP3
<input type="checkbox"/> Create the beep melody for Bell ringer function.	15 [BP USR]	---
<input type="checkbox"/> Setting of the DCS code.	24 [DCS CD]	104 standard DCS codes (023)
<input type="checkbox"/> Enables / Disables the "Inverted" DCS Tone.	25 [DCS RV]	R-N-T-N / R-I-T-N / R-B-T-N / R-N.T.I / R-I.T-I / R-B.T-I
<input type="checkbox"/> Enables / Disables the Answer Back function of the Enhanced CTCSS Paging & Code Squelch.	60 [PAG.ABK]	ON / OFF
<input type="checkbox"/> Sets the Receiver Pager Code for the Enhanced CTCSS Paging & Code Squelch.	61 [PAG.CDR]	---
<input type="checkbox"/> Sets the Transmitting Pager Code for the Enhanced CTCSS Paging & Code Squelch.	62 [PAG.CDT]	---
<input type="checkbox"/> Program the CTCSS Tone frequency for the User programmed Reverse CTCSS Decoder.	63 [PR FRQ]	300Hz - 3000Hz (1000 Hz/step) (1600Hz)
<input type="checkbox"/> Sets the Squelch threshold level.	78 [SQ LVL]	LVL 0 - LVL 15 (LVL 1) (AM and Narrow FM), LVL 0 - LVL 8 (LVL 2) (Wide FM and AM Broadcast)
<input type="checkbox"/> Selects the Sub Audible Squelch Type.	79 [SQ TYP]	OFF / TONE / TSQ / DCS / RV TN / PR FRQ / PAGER / MESSAGE
<input type="checkbox"/> Enables / Disables split CTCSS / DCS coding.	81 [SQSPLT]	ON / OFF
<input type="checkbox"/> Setting of the CTCSS Tone Frequency.	86 [TN FRQ]	50 standard CTCSS tones (100Hz)
ARTS SETTING	SET MODE ITEM	AVAILABLE VALUES (DEFAULT: BOLD ITALIC)
<input type="checkbox"/> Selects the Beep option during ARTS™ operation.	6 [ARTSBP]	OFF / IN RNG / ALWAYS
<input type="checkbox"/> Selects the Polling Interval during ARTS™ operation.	7 [ARTSIT]	15SEC / 25SEC
<input type="checkbox"/> Programs and activates the CW Identifier (used during ARTS™ operation).	19 [CW ID]	---
MEMORY SETTING	SET MODE ITEM	AVAILABLE VALUES (DEFAULT: BOLD ITALIC)
<input type="checkbox"/> Stores Alpha-Numeric "Tags" for the Memory Banks.	11 [BNK.NAM]	---
<input type="checkbox"/> Toggles the display indication between "frequency" and "Alpha/Numeric" channel tags.	49 [MR DSP]	ALPHA / FREQ
<input type="checkbox"/> Determines the method of selecting channels for Memory Storage.	50 [MR WMD]	NEXT / LOWER
<input type="checkbox"/> Selects the channel step for the fast channel selection mode while in the Memory Recall mode.	51 [MRFSTP]	10CH / 20CH / 50CH / 100CH
<input type="checkbox"/> Stores "Alpha-Numeric" tags for the Memory channels.	52 [MRNAME]	---
<input type="checkbox"/> Enables / Disables the Memory Write Protector.	53 [MRPTCT]	ON / OFF
SCAN SETTING	SET MODE ITEM	AVAILABLE VALUES (DEFAULT: BOLD ITALIC)
<input type="checkbox"/> Selects the Memory Scan, channel-selection mode.	54 [MRSKIP]	OFF / SKIP / ONLY
<input type="checkbox"/> Enables / Disables the Priority Revert feature.	64 [PRI.RVT]	ON / OFF
<input type="checkbox"/> Selects the time between the Priority (Dual Watch) channel checks, when the feature is active.	65 [PRI.TMR]	0.1 - 0.9S (0.1S/step) or 1.0S - 10.0S (0.5S/step) (5.0S)
<input type="checkbox"/> Enables / Disables the Scan lamp (while scanning is paused)	74 [SCN.LMP]	ON / OFF
<input type="checkbox"/> Selects the Scan Resume mode.	75 [SCN.RSM]	2SEC - 10SEC / BUSY / HOLD (5SEC)
<input type="checkbox"/> Select the Scan Re-start Delay time.	76 [SCN.STR]	0.1-0.4S (0.1S/step) or 1.0S - 10.0S (0.5S/step) (2.0S)
<input type="checkbox"/> Enables / Disables the receiver audio output while the Tone Search Scanner is activated.	88 [TS MUT]	ON / OFF
<input type="checkbox"/> Selects the Tone Search Scanner speed.	89 [TS SPD]	SLOW (1.25 tone/sec) / FAST (2.5 tone/sec)
BATTERY SAVING SETTING	SET MODE ITEM	AVAILABLE VALUES (DEFAULT: BOLD ITALIC)
<input type="checkbox"/> Setting of the Automatic Power-Off feature.	4 [APO]	OFF / 0.5H - 12.0H (0.5H/steps)
<input type="checkbox"/> Enables / Disables the BUSY LED while the Squelch is open.	16 [BSY.LED]	ON / OFF
<input type="checkbox"/> Selects the Receive-mode Battery Saver interval ("sleep" ratio)	72 [SAVERX]	0.2S - 0.9S (0.1S/step) or 1.0S - 10.0S (0.5S/step)
<input type="checkbox"/> Enables / Disables the Transmitter Battery Saver.	73 [SAVETX]	ON / OFF
<input type="checkbox"/> Setting of the Wakeup feature.	93 [WAKEUP]	OFF / 5SEC - 60SEC(5SEC/step) / EI
MESSAGE SETTING	SET MODE ITEM	AVAILABLE VALUES (DEFAULT: BOLD ITALIC)
<input type="checkbox"/> Programming a Member List for the Message feature.	55 [MSG.LST]	---
<input type="checkbox"/> Selects your Personal ID for the Message feature.	56 [MSG.REG]	---
<input type="checkbox"/> Programming a Message for the Message feature.	57 [MSG.SEL]	---
WIRES SETTING	SET MODE ITEM	AVAILABLE VALUES (DEFAULT: BOLD ITALIC)
<input type="checkbox"/> Selects the Access Number (DTMF digit) for the SRG operation of the Internet Connection feature (WIRES™).	38 [INT CD]	DTMF 0 - DTMF F (DTMF 1)
<input type="checkbox"/> Selects the operating mode of the Internet Connection feature (WIRES™).	39 [INT MD]	SRG / FRG
<input type="checkbox"/> Enables / Disables the DTMF Autodialer, while operating the Internet Connection feature (WIRES™).	40 [INT.A/M]	MANUAL / AUTO
<input type="checkbox"/> Programming of the Access Number (DTMF code) for the FRG station of the WIRES™ (or non WIRES™ Internet Link System) access.	41 [INT.SEL]	---
<input type="checkbox"/> Selects the function of the [X] key.	42 [INTKEY]	INTNET / INT MR / SET MD
<input type="checkbox"/> Enables / Disables the Internet Connection feature (WIRES™).	43 [INTNET]	ON / OFF

SET (MENU) MODE

EAI SETTING	SET MODE ITEM	AVAILABLE VALUES (DEFAULT: BOLD Italic)
<input type="checkbox"/> Enables / Disables the Emergency Automatic ID (EAI) feature.	30 [EAI]	ON / OFF
<input type="checkbox"/> Sets the Emergency Automatic ID (EAI) operating mode and its Transmit Time.	31 [EAI.TMR]	INT. 1M through INT.10M, INT. 15M, INT.20M, INT.30M, INT.40M, INT. 50M, CON. 1M through CON. 10M, CON. 15M, CON.20M, CON. 30M, CON.40M, and CON. 50M (CON. 5M)
<input type="checkbox"/> Select the alarms utilized when the Emergency function is engaged.	32 [EMG.SEL]	BEEP / STROBE / BP+STR / BEAM /BP+BEM / CW / BP+CW / CWT
DTMF SETTING	SET MODE ITEM	AVAILABLE VALUES (DEFAULT: BOLD Italic)
<input type="checkbox"/> Enables / Disables the DTMF Autodial feature.	26 [DT A/M]	MANUAL / AUTO
<input type="checkbox"/> Selects the DTMF Autodialer Delay Time.	27 [DT DLY]	50MS / 250MS / 450MS / 750MS / 1000MS
<input type="checkbox"/> Programming of the DTMF Autodialer.	28 [DT SEL]	---
<input type="checkbox"/> Selects the DTMF Autodialer Sending Speed.	29 [DT SPD]	50MS / 100MS
SWITCH/KNOB SETTING	SET MODE ITEM	AVAILABLE VALUES (DEFAULT: BOLD Italic)
<input type="checkbox"/> Set the duration that a secondary function of the [F/W] key (press and holding the [F/W] key) is held determines the function they activate.	34 [FW KEY]	FW0.3S / FW0.5S / FW0.7S / FW1.0S /FW1.5S
<input type="checkbox"/> Selects the function of the [HM/RV] key.	36 [HM/RV]	HOME / REV
<input type="checkbox"/> Enables / Disables the function of the VFO DIAL knob, while in the Home Channel mode.	37 [HM+VFO]	DISAB / ENABLE
<input type="checkbox"/> Select the DIAL knob function.	92 [VOL MD]	NORMAL / AUT.BCK
DISPLAY SETTING	SET MODE ITEM	AVAILABLE VALUES (DEFAULT: BOLD Italic)
<input type="checkbox"/> Selects the LCD/Keypad Lamp mode.	44 [LAMP]	KEY 2S - KEY10S / CONT / OFF (KEY 5S)
<input type="checkbox"/> Selects the Control Locking lockout combination.	46 [LOCK]	KEY / PTT / KY (KEY)+PTT
<input type="checkbox"/> Selects the function of the MONI.T.CALL switch (just below the PTT switch).	47 [MT-CL]	MONI / T-CALL
<input type="checkbox"/> Selects the time delay before the carrier is transmitted, when the PTT switch is pressed.	67 [PTT.DLY]	(Depends on the transceiver version) OFF / 20MS / 50MS / 100MS / 200MS
BEEP SETTING	SET MODE ITEM	AVAILABLE VALUES (DEFAULT: BOLD Italic)
<input type="checkbox"/> Enables / Disables the Band-edge beeper while selecting the frequency by the DIAL knob.	12 [BP EDG]	ON / OFF
<input type="checkbox"/> Adjust the Beep volume level.	13 [BP LVL]	LVL 1 - LVL 9 (LVL 5)
<input type="checkbox"/> Enables / Disables the Beep beeper.	14 [BP SEL]	OFF / KY+SCN / KEY
<input type="checkbox"/> Select the CW tone pitch for the CW Learn, CW training, and CW Identifier functions.	21 [CWPICT]	400 - 1000 Hz (50 Hz/step) (700 Hz)
DISPLAY SETTING	SET MODE ITEM	AVAILABLE VALUES (DEFAULT: BOLD Italic)
<input type="checkbox"/> Indicates the DC Supply Voltage.	23 [DC VLT]	---
<input type="checkbox"/> Selects the Opening Message that appears when the radio is powered on.	59 [OPN.MSG]	OFF / DC / MSG
<input type="checkbox"/> Indicates the current temperature inside the transceiver's case and selects the measurement units ("°F" or "°C") for the temperature sensor.	85 [TEMP]	---
MISCELLANEOUS SETTING	SET MODE ITEM	AVAILABLE VALUES (DEFAULT: BOLD Italic)
<input type="checkbox"/> Select the antenna to be used in the AM Broadcast listening.	1 [ANT AM]	BAREXT / BARANT
<input type="checkbox"/> Selects the Channel Counter Search Width.	17 [CH CNT]	±5 MHz / ±10 MHz / ±50 MHz / ±100 MHz
<input type="checkbox"/> Shifting of the CPU clock frequency.	18 [CLK.SFT]	ON / OFF
<input type="checkbox"/> Select the antenna to be used in the FM Broadcast listening.	2 [ANT FM]	EXTANT / EARPHO
<input type="checkbox"/> Enables / Disables the CW Learning feature.	20 [CWLNRG]	---
<input type="checkbox"/> Enables / Disables the CW Training feature.	22 [CWTRNG]	---
<input type="checkbox"/> Enables / Disables the receiver Front-end Attenuator.	3 [ANT.ATT]	ON / OFF
<input type="checkbox"/> Enables / Disables the extended Set Mode Menu.	33 [EXT.MNU]	ON / OFF
<input type="checkbox"/> Reduce the Deviation level by 50 %.	35 [HLF.DEV]	ON / OFF
<input type="checkbox"/> Illuminates the TX/BUSY indicator. It will glow continuously white (useful as emergency flashlight at night).	45 [LED LT]	---
<input type="checkbox"/> Adjust the microphone gain level.	48 [MCGAIN]	LVL 1 - LVL 9 (LVL 5)
<input type="checkbox"/> Set the On Timer Time.	58 [ON TMR]	OFF / 00H.10M(00:10) - 24H.00M(24:00) (10 minutes/step)
<input type="checkbox"/> Programs and activates the Password feature.	66 [PSWD]	---
<input type="checkbox"/> Selects the Receiving mode.	70 [RX MD]	AUTO / N-FM / AM / W-FM
<input type="checkbox"/> Selects the Smart Search Sweep mode.	71 [S SRCH]	SINGLE / CONT
<input type="checkbox"/> Enables / Disables the FM Broadcast audio output to the internal speaker when using the earphone antenna.	77 [SP OUT]	AUTO / SPKR
<input type="checkbox"/> Enables / Disables the Busy Channel Lock-Out feature.	8 [BCLO]	ON / OFF
<input type="checkbox"/> Adjusts the Squelch threshold to the S-meter level.	80 [SQSMTR]	OFF / LVL 1 - LVL 8
<input type="checkbox"/> Setting the Dial frequency steps.	82 [STEP]	AUTO / 5 / 8.33 / 9 / 10 / 12.5 / 15 / 20 / 25 / 50 / 100 kHz
<input type="checkbox"/> Enables / Disables stereo out put, while receiving the FM Broadcast band.	83 [STEREO]	STEREO / MONO
<input type="checkbox"/> Sets the time before Broadcast audio is resumed after the amateur band signal drops, when the AF Priority function is activated.	84 [SUB-RX]	OFF / TRX 1S - TRX 10S (1S/step) / HOLD / TX 1S - TX 10S (1S/step)
<input type="checkbox"/> Setting of the TOT time	87 [TOT]	OFF / 0.5M - 10.0M (0.5M/step) (3.0M : 3 minutes)
<input type="checkbox"/> Selects or disables the VFO band edge limiting for the current band.	90 [VFO MD]	ALL / BAND
<input type="checkbox"/> Set My Band.	91 [VFO SKP]	ON / OFF
<input type="checkbox"/> Enables/Disables the NOAA Weather Alert Feature.	94 [WX ALT]	OFF / ON

SET (MENU) MODE

Set Mode Item 1 [ANT AM]

Function: Select the antenna to be used in the AM Broadcast listening.

Available Values: BAREXT/BARANT

Default: BAREXT

BAREXT: Uses both the internal Bar Antenna and the Rubber Flex Antenna.

BARANT: Uses the internal Bar Antenna only.

The Bar Antenna is directional; rotate the **VX-3R/E** for best reception.

Set Mode Item 2 [ANT FM]

Function: Select the antenna to be used in the FM Broadcast listening.

Available Values: EXTANT/EARPHO

Default: EXTANT

EXTANT: Uses the Rubber Flex Antenna.

EARPHO: Uses the Earphone Antenna. When receiving a weak signal, reception may be noisy.

Set Mode Item 3 [ANT.ATT]

Function: Enables/Disables the receiver Front-end Attenuator.

Available Values: ON/OFF

Default: OFF

Note: This Set Mode Item can select and set the function to each memory channel individually.

Set Mode Item 4 [APO]

Function: Setting of the Automatic Power-Off feature.

Available Values: OFF/0.5H - 12.0H (0.5H/steps)

Default: OFF

Set Mode Item 5 [ARS]

Function: Enables/Disables the Automatic Repeater Shift function.

Available Values: ON/OFF

Default: ON

Set Mode Item 6 [ARTSBP]

Function: Selects the Beep option during ARTS™ operation.

Available Values: OFF/IN RNG/ALWAYS

Default: IN RNG

OFF: No alert beeps sound.

IN RNG: Beeps sound only when the radio first detects that you are within range.

ALWAYS: Beeps sound every time a polling transmission is received from the other station (every 15 or 25 seconds when in range).

Set Mode Item 7 [ARTSIT]

Function: Selects the Polling Interval during ARTS™ operation.

Available Values: 15SEC/25SEC

Default: 25SEC

Set Mode Item 8 [BCLO]

Function: Enables/Disables the Busy Channel Lock-Out feature.

Available Values: ON/OFF

Default: OFF

Set Mode Item 9 [BEL.RNG]

Function: Selects the number of Bell ringer repetitions.

Available Values: 1T - 20T/CONT (Continuous ringing)

Default: 1T

Set Mode Item 10 [BEL.SEL]

Function: Enables/Disables the Bell ringer function and its sound selection.

Available Values: OFF/BELL/USRBP1/ USRBP2/ USRBP3

Default: OFF

Note: This Set Mode Item can select and set the function to each memory channel individually.

Set Mode Item 11 [BNK.NAM]

Function: Stores Alpha-Numeric “Tags” for the Memory Banks.

See page 49 for details.

Set Mode Item 12 [BP ED]

Function: Enables/Disables the Band-edge beeper while selecting the frequency by the DIAL knob.

Available Values: ON/OFF

Default: OFF

Set Mode Item 13 [BP LVL]

Function: Adjust the Beep volume level.

Available Values: LVL 1 - LVL 9

Default: LVL 5

Set Mode Item 14 [BP SEL]

Function: Enables/Disables the Keypad beeper.

Available Values: OFF/KY+SCN/KEY

Default: KY+SCN

OFF: The Beeper is disabled.

KY+SCN: The beeper sounds when you press a key or when the scanner stops.

KEY: The beeper sounds when you press any key.

SET (MENU) MODE

Set Mode Item 15 [BP USR]

Function: Create the beep melody for Bell ringer function.

See page 38 for details.

Set Mode Item 16 [BSY.LED]

Function: Enables/Disables the **BUSY** LED while the Squelch is open.

Available Values: ON/OFF

Default: ON

Set Mode Item 17 [CH CNT]

Function: Selects the Channel Counter Search Width.

Available Values: ± 5 MHz/ ± 10 MHz/ ± 50 MHz/ ± 100 MHz

Default: ± 5 MHz

Set Mode Item 18 [CLK.SFT]

Function: Shifting of the CPU clock frequency.

Available Values: ON/OFF

Default: OFF

Note: 1) This Set Mode Item can select and set the function to each memory channel individually.

2) This function is only used to move a spurious response “birdie,” should it fall on a desired frequency.

Set Mode Item 19 [CW ID]

Function: Programs and activates the CW Identifier (used during ARTS operation).

See page 81 for details.

Set Mode Item 20 [CWLRNG]

Function: Enables/Disables the CW Learning feature.

See page 88 for details.

Set Mode Item 21 [CWPICT]

Function: Select the CW tone pitch for the CW Learn, CW training, and CW Identifier functions.

Available Values: 400 - 1000 Hz (50 Hz/step)

Default: 700 Hz

Set Mode Item 22 [CWTRNG]

Function: Enables/Disables the CW Training feature.

See page 90 for details.

Set Mode Item 23 [DC VLT]

Function: Indicates the DC Supply Voltage.

Set Mode Item 24 [DCS CD]

Function: Setting of the DCS code.

Available Values: 104 standard DCS codes

Default: DCS.023

Note: This Set Mode Item can select and set the function to each memory channel individually.

DCS CODE										
023	025	026	031	032	036	043	047	051	053	
054	065	071	072	073	074	114	115	116	122	
125	131	132	134	143	145	152	155	156	162	
165	172	174	205	212	223	225	226	243	244	
245	246	251	252	255	261	263	265	266	271	
274	306	311	315	325	331	332	343	346	351	
356	364	365	371	411	412	413	423	431	432	
445	446	452	454	455	462	464	465	466	503	
506	516	523	526	532	546	565	606	612	624	
627	631	632	654	662	664	703	712	723	731	
732	734	743	754	-	-	-	-	-	-	

Set Mode Item 25 [DCS RV]

Function: Enables/Disables the “Inverted” DCS Tone.

Available Values: R-N.T-N/R-I.T-N/R-B.T-N/
R-N.T.I/R-I.T-I/R-B.T-I

Default: R-N.T-N

R-N.T-N: Receive and transmit the Normal DCS Tone.

R-I.T-N: Receive the Inverted DCS Tone and transmit the Normal DCS Tone.

R-B.T-N: Receive the both Normal and Inverted DCS Tones and transmit the Normal DCS Tone.

R-N.T.I: Receive the Normal DCS Tone and transmit the Inverted DCS Tone.

R-I.T-I: Receive and transmit the Inverted DCS Tone.

R-B.T-I: Receive the both Normal and Inverted DCS Tones and transmit the Inverted DCS Tone.

Note: This Set Mode Item can select and set the function to each memory channel individually.

Set Mode Item 26 [DT A/M]

Function: Enables/Disables the DTMF Autodial feature.

Available Values: MANUAL/AUTO

Default: MANUAL

Set Mode Item 27 [DT DLY]

Function: Selects the DTMF Autodialer Delay Time.

Available Values: 50MS/250MS/450MS/750MS/1000MS

Default: 450MS

Set Mode Item 28 [DT SEL]

Function: Programming of the DTMF Autodialer.

See page 85 for details.

Set Mode Item 29 [DT SPD]

Function: Selects the DTMF Autodialer Sending Speed.

Available Values: 50MS/100MS

Default: 50MS

SET (MENU) MODE

Set Mode Item 30 [EAI]

Function: Enables/Disables the Emergency Automatic ID (EAI) feature..

Available Values: ON/OFF

Default: OFF

Set Mode Item 31 [EAI.TMR]

Function: Sets the Emergency Automatic ID (EAI) operating mode and its Transmit Time.

Available Values:

INT. 1M through INT.10M, INT.15M, INT.20M, INT.30M, INT.40M, INT. 50M,

CON. 1M through CON.10M, CON.15M, CON.20M, CON.30M, CON.40M, and CON. 50M

Default: CON. 5M

Set Mode Item 32 [EMG.SEL]

Function: Select the alarms utilized when the Emergency function is engaged.

Available Values: BEEP/STROBE/BP+STR/BEAM/BP+BEM/CW/BP+CW/CWT

Default: BP+STR

BEEP (BP): Loud “Alarm” sounds.

STROBE (STB): Flashes the **TX/BUSY** indicator in bright white color.

BP+STB: Loud “Alarm” sounds along with flashing of the **TX/BUSY** indicator in white.

BEAM: The **TX/BUSY** indicator glows continuously in white.

BP+BEM: Loud “Alarm” sounds and the **TX/BUSY** indicator glows continuously in white.

CW: The **TX/BUSY** indicator flashes according to the programmed Emergency message (Morse Code)* at a rate of five words per minute.

BP+CW: Sounds tones via the speaker, and flashes the **TX/BUSY** indicator, according to the programmed Emergency message (Morse Code)* at a rate of five words per minute.

CWT: Transmits the programmed Emergency message (Morse Code)* and flashes the **TX/BUSY** indicator, according to the programmed Emergency message (Morse Code)* on the air beginning one minute after activation of the Emergency function.

※: The internationally-recognized Morse Code “S.O.S” message (•••---•••) is programmed at the factory for the Emergency message.

Here’s how to program the Emergency Message:

1. Set this Set Mode Item to “CW” or “BP+CW.”
2. Press the [V/M] key to display any previously-stored emergency message.
3. Press the [HM/RV] key to clear any previous emergency message, if desired.
4. Rotate the **DIAL** knob to select the first letter/number of the message, then press the [V/M] key momentarily to save the first letter/number and move on to the next character.

5. Repeat the previous step as necessary to complete the message (up to 16 characters).
6. If you make a mistake, press the **[BAND]** key to backspace the cursor; now re-enter the correct letter/number.
7. Press the **[HM/RV]** key to delete all data after the cursor that may have been previously stored erroneously.
8. When you have entered the message, press the **[TXPO]** key momentarily to confirm the message, then press the **PTT** switch to save the settings and exit to normal operation.

Set Mode Item 33 [EXT.MNU]

Function: Enables/Disables the extended Set Mode Menu.

Available Values: ON/OFF

Default: OFF

Set Mode Item 34 [FW KEY]

Function: Set the duration that a secondary function of the **[F/W]** key (press and holding the **[F/W]** key) is held determines the function they activate.

Available Values: FW0.3S/FW0.5S/FW0.7S/ FW1.0S/FW1.5S

Default: FW0.5S

Set Mode Item 35 [HLF.DEV]

Function: Reducing the Deviation level by 50 %.

Available Values: ON/OFF

Default: OFF

Note: This Set Mode Item can select and set the function to each memory channel individually.

Set Mode Item 36 [HM/RV]

Function: Selects the function of the **[HM/RV]** key.

Available Values: HOME/REV

Default: REV

HOME: Pressing the **[HM/RV]** key instantly recalls a favorite “Home” channel.

REV: Pressing the **[HM/RV]** key reverses transmit and receive frequencies during repeater operation.

Set Mode Item 37 [HM>VFO]

Function: Enables/Disables the function of the VFO **DIAL** knob, while in the Home Channel mode.

Available Values: DISABL/ENABLE

Default: ENABLE

SET (MENU) MODE

Set Mode Item 38 [INT CD]

Function: Selects the Access Number (DTMF digit) for the SRG operation of the Internet Connection feature (WIRES™).

Available Values: DTMF 0 - DTMF F

Default: DTMF 1

Set Mode Item 39 [INT MD]

Function: Selects the operating mode of the Internet Connection feature (WIRES™).

Available Values: SRG/FRG

Default: SRG

Set Mode Item 40 [INT.A/M]

Function: Enables/Disables the DTMF Autodialer feature while operating using the Internet Connection feature (WIRES™).

Available Values: MANUAL/AUTO

Default: MANUAL

Set Mode Item 41 [INT.SEL]

Function: Programming of the Access Number (DTMF code) for the FRG station of the WIRES™ (or non WIRES™ Internet Link System) access.

See page 83 for details.

Set Mode Item 42 [INTKEY]

Function: Selects the function of the [ⓧ] key.

Available Values: INTNET/INT MR/SET MD

Default: INTNET

INTNET: The [ⓧ] key activates/disables the internet feature.

INT MR: The [ⓧ] key recalls the Internet Access Number (SRG) or Access String (FRG). (SRG) or (FRG) is determined via Set Mode Item 39: INT MD.

SET MD: The [ⓧ] key is the Short-cut path to recall one of the Set Mode Items. See page 92 for programming.

Set Mode Item 43 [INTNET]

Function: Enables/Disables the Internet Connection feature (WIRES™).

Available Values: ON/OFF

Default: OFF

Set Mode Item 44 [LAMP]

Function: Selects the LCD/Keypad Lamp mode.

Available Values: KEY 2S - KEY10S/CONT/OFF

Default: KEY 5S (5 seconds)

KEY 2S - KEY10S: Illuminates the LCD/Keypad for the selected time, when any key is pressed.

CONT: Illuminates the LCD/Keypad continuously.

OFF: Disables the LCD/Keypad illumination

Set Mode Item 45 [LED LT]

Function: Illuminates the **TX/BUSY** indicator. It will glow continuously white (useful as emergency flashlight at night).

Set Mode Item 46 [LOCK]

Function: Selects the Control Locking lockout combination.

Available Values: KEY/PTT/KY(KEY)+PTT

Default: KEY

Set Mode Item 47 [M/T-CL]

Function: Selects the function of the **MONI/T.CALL** switch (just below the **PTT** switch) function.

Available Values: MONI/T-CALL

Default: Depends on the transceiver version.

MONI: Pressing the **MONI/T.CALL** switch will over ride the Noise/Tone Squelch, allowing you to listen for weak (or non-encoded) signals.

T-CALL: Pressing the **MONI/T.CALL** switch activates a 1750-Hz burst tone, used for repeater access in many countries.

Set Mode Item 48 [MCGAIN]

Function: Adjust the microphone gain level.

Available Values: LVL 1 - LVL 9

Default: LVL 5

This Set Mode setting affects both internal and external microphones.

Set Mode Item 49 [MR DSP]

Function: Toggles the display indication between “frequency” and “Alpha/Numeric” channel tags.

Available Values: ALPHA/FREQ

Default: FREQ

Note: This Set Mode Item can select and set the function to each memory channel individually.

SET (MENU) MODE

Set Mode Item 50 [MRWMD]

Function: Determines the method of selecting channels for Memory Storage.

Available Values: NEXT/LOWER

Default: NEXT

NEXT: Stores the data into the memory channel, which is next highest from the last-stored memory channel.

LOWER: Stores the data into the next-available “free” channel.

Set Mode Item 51 [MRFSTP]

Function: Selects the channel step for the fast channel selection mode while in the Memory Recall mode.

Available Values: 10CH/20CH/50CH/100CH

Default: 10CH

Set Mode Item 52 [MRNAME]

Function: Stores “Alpha-Numeric” tags for the Memory channels.

See page 45 for details.

Note: This Set Mode Item can select and set the function to each memory channel individually.

Set Mode Item 53 [MRPTCT]

Function: Enables/Disables the Memory Write Protector.

Available Values: ON/OFF

Default: OFF

When this function is set to “ON”, the memory write operation is ignored.

Set Mode Item 54 [MRSKIP]

Function: Selects the Memory Scan channel-selection mode.

Available Values: OFF/SKIP/ONLY

Default: OFF

OFF: All memory channels will be scanned (the “flag” will be ignored).

SKIP: The scanner will “skip” the flagged channels during scanning.

ONLY: The scanner will only scan channels that are flagged (Preferential Scan List).

Note: This Set Mode Item can select and set the function to each memory channel individually.

Set Mode Item 55 [MSG.LST]

Function: Programming a Member List for the Message feature.

See page 71 for details.

Set Mode Item 56 [MSG.REG]

Function: Selects your Personal ID for the Message feature.

See page 72 for details.

Set Mode Item 57 [MSG.SEL]

Function: Programming a Message for the Message feature.

See page 70 for details.

Set Mode Item 58 [ON TMR]

Function: Set the On Timer Time.

Available Values: OFF/00H.10M(00:10) 24H.00M(24:00) (10 minutes/step)

Default: OFF

The On Timer turns on the radio at the programmed time.

Set Mode Item 59 [OPN.MSG]

Function: Selects the Opening Message that appears when the radio is powered on.

Available Values: OFF/DC/MSG

Default: DC

OFF: No Opening Message

DC: DC supply voltage

MSG: Set by user. See below.

Here's how to program the Opening Message:

1. Select this Set Mode Item to "MSG."
2. Press the **[V/M]** key momentarily to enable programming of the opening message. You will notice the first character entry's location blinking.
3. Rotate the **DIAL** knob to select the first letter/number of the message, then press the **[V/M]** key momentarily to save the first letter/number and move on to the next character.

Note: Do not forget to pull the **DIAL** knob to rotate the **DIAL** knob

4. Repeat the steps 3 and 4 as necessary to complete the message (up to six characters).
5. If you make a mistake, press the **[BAND]** key to back-space the cursor; now re-enter the correct letter/number.
6. When you have entered the desired opening message, press the **[TXPO]** key momentarily to confirm the message, then press the **PTT** switch to save the settings and exit to normal operation.

Set Mode Item 60 [PAG.ABK]

Function: Enables/Disables the Answer Back function of the Enhanced CTCSS Paging & Code Squelch.

Available Values: ON/OFF

Default: OFF

Set Mode Item 61 [PAG.CDR]

Function: Sets the Receiver Pager Code for the Enhanced CTCSS Paging & Code Squelch. See page 34 for details.

SET (MENU) MODE

Set Mode Item 62 [PAG.CDT]

Function: Sets the Transmitting Pager Code for the Enhanced CTCSS Paging & Code Squelch.

See page 34 for details.

Set Mode Item 63 [PR FRQ]

Function: Program the CTCSS Tone frequency for the User programmed Reverse CTCSS Decoder.

Available Values: 300Hz - 3000Hz (1000 Hz/step)

Default: 1600 Hz

Note: This Set Mode Item can select and set the function to each memory channel individually.

Set Mode Item 64 [PRI.RVT]

Function: Enables/Disables the Priority Revert feature.

Available Values: ON/OFF

Default: OFF

See page 63 for details.

Set Mode Item 65 [PRI.TMR]

Function: Selects the time between the Priority (Dual Watch) channel checks, when the feature is active.

Available Values: 0.1 - 0.9S (0.1S/step) or 1.0S - 10.0S (0.5S/step)

Default: 5.0S

See page 62 for details.

Set Mode Item 66 [PSWD]

Function: Programs and activates the Password feature.

See page 91 for details.

Set Mode Item 67 [PTT.DLY]

Function: Selects the time delay before the carrier is transmitted, when the **PTT** switch is pressed.

Available Values: OFF/20MS/50MS/100MS/200MS

Default: OFF

Set Mode Item 68 [RPT]

Function: Sets the Repeater Shift Direction.

Available Values: SIMP/-RPT/+RPT

Default: Depends on the transceiver version, as well as the setting of Set Mode Item 5 ARS.

Note: This Set Mode Item can select and set the function to each memory channel individually.

Set Mode Item 69 [RPT.SFT]

Function: Sets the magnitude of the repeater Shift.

Available Values: 0.00 - 150.00 MHz (50 kHz/step)

Default: Depends on the operating band and transceiver version.

If you press the **[F/W]** key momentarily, then rotate the **DIAL** knob, frequency steps of 1 MHz will be selected.

Note: This Set Mode Item can select and set the function to each memory channel individually.

Set Mode Item 70 [RX MD]

Function: Selects the Receiving mode.

Available Values: AUTO/N-FM/AM/W-FM

Default: AUTO (Mode automatically changes according to operating frequency.)

Note: This Set Mode Item can select and set the function to each memory channel individually.

Set Mode Item 71 [S SRCH]

Function: Selects the Smart Search Sweep mode.

Available Values: SINGLE/CONT

Default: SINGLE

SINGLE: The transceiver sweeps the current band once in each direction starting on the current frequency. All channels where activity is present (up to 15 in each direction) are loaded into the Smart Search memories. Whether or not all 31 memories are filled, the search stops after one sweep in each direction.

CONT: The transceiver makes a sweep in each direction as with the "SINGLE" mode, but if all 31 channels are not filled after the first sweep, the radio continues sweeping until they are all filled.

Set Mode Item 72 [SAVERX]

Function: Selects the Receive-mode Battery Saver interval ("sleep" ratio)

Available Values: 0.2 - 0.9S (0.1S/step) or 1.0S - 10.0S (0.5S/step)

Default: 0.2 S (1:1)

Set Mode Item 73 [SAVETX]

Function: Enables/Disables the Transmitter Battery Saver.

Available Values: ON/OFF

Default: OFF

Set Mode Item 74 [SCN.LMP]

Function: Enables/Disables the Scan lamp (while scanner is paused).

Available Values: ON/OFF

Default: ON

SET (MENU) MODE

Set Mode Item 75 [SCN.RSM]

Function: Selects the Scan Resume mode.

Available Values: 2SEC - 10SEC/BUSY/HOLD

Default: 5 SEC

2 SEC - 10 SEC: The scanner will halt on a signal it encounters, and will hold there for the selected resume time. If you do not take action to disable the scanner within that time period, the scanner will resume even if the station is still active.

BUSY: The scanner will halt on a signal it encounters. When the signal drops, the scanner will resume. The Scan resume time (default 2 seconds) is controlledset by the Set Mode Item 76: SCN.STR.

HOLD: The scanner will halt on a signal it encounters. It will not restart automatically; you must manually re-initiate scanning if you wish to resume.

Set Mode Item 76 [SCN.STR]

Function: Select the Scan Re-start Delay time.

Available Values: 0.1 - 0.4S (0.1S/step) or 1.0S - 10.0S (0.5S/step)

Default: 2.0S

Set Mode Item 77 [SP OUT]

Function: Enables/Disables the FM Broadcast audio output to the internal speaker when using the earphone antenna.

Available Values: AUTO/SPKR

Default: AUTO

AUTO: The FM Broadcast audio output is selected automatically depending on the connection of the earphone antenna.

SPKR: Outputs the FM Broadcast audio output to the internal speaker any time.

Set Mode Item 78 [SQ LVL]

Function: Sets the Squelch threshold level.

Available Values: LVL 0 - LVL 15 (AM and Narrow FM), LVL 0 - LVL 8 (Wide FM and AM Broadcast)

Default: LVL 1 (AM and Narrow FM), LVL 2 (Wide FM and AM Broadcast)

Set Mode Item 79 [SQ TYP]

Function: Selects the Sub Audible Squelch Type.

Available Values: OFF/TONE/TSQL/DCS/RV TN/PR FRQ/PAGER/MESSAGE

Default: OFF

TONE: Activates the CTCSS Encoder

TSQ: Activates the CTCSS Encoder/Decoder

DCS: Activates the Digital Coded Encoder/Decoder

RV TN: Activates the Reverse CTCSS Decoder (Mutes the receiver when matching tone is received)

PR FRQ: Activates the User programmed Reverse CTCSS Decoder (Mutes the receiver when the matching tone programmed with Set Mode Item 63: PR FRQ is received)

PAGER: Activates the Enhanced Paging & Code Squelch

MESSAGE: Activates the Message feature

Note: 1) This Set Mode Item can select and set the function to each memory channel individually.

2) See also Set Mode Item 81: SQSPLT regarding additional selections available during “Split Tone” operation.

Set Mode Item 80 [SQSMTR]

Function: Adjusts the Squelch threshold to the S-meter level.

Available Values: OFF/LVL 1 - LVL 8

Default: OFF

Note: This Set Mode Item can select and set the function to each memory channel individually.

Set Mode Item 81 [SQSPLT]

Function: Enables/Disables split CTCSS/DCS coding.

Available Values: ON/OFF

Default: OFF

When this Set Mode Item is set to “ON,” you can see the following additional parameters after the “MESSAGE” parameter while selecting the Set Mode Item 79: SQ TYP.

D CODE: DCS Encode only.

T DCS: Encodes a CTCSS tone and Decodes a DCS code.

D TONE: Encodes a DCS code and Decodes a CTCSS tone.

Select the desired operating mode from the selections shown above.

SET (MENU) MODE

Set Mode Item 82 [STEP]

Function: Setting the Dial frequency steps.

Available Values: AUTO/5/8.33/9/10/12.5/15/20/25/50/100 kHz

Default: AUTO (Step automatically changes according to operating frequency.)

Note: 1) This Set Mode Item can select and set the Dial frequency steps to individual memory channels when Memory Offset Tuning is enabled as shown on page 46.

2) 9 kHz steps are available only when receiving on the BC band.

3) 8.33 kHz steps are available only when receiving on the Air band.

4) While operating on the BC band, you may only select channel steps of 9 kHz or 10 kHz; the other step selections are disabled.

5) 5 kHz steps are not available for use on 250 - 300 MHz, nor above 580 MHz.

Set Mode Item 83 [STEREO]

Function: Enables/Disables the stereo output, while receiving the FM Broadcast band.

Available Values: STEREO/MONO

Default: STEREO

Note: This Set Mode Item can select and set the function to each memory channel individually.

Set Mode Item 84 [SUB-RX]

Function: Sets the time before Broadcast audio is resumed after the amateur band signal drops, when the AF Priority function is activated.

Available Values: OFF/TRX 1S - TRX 10S (1S/step)/HOLD/ TX 1S - TX 10S (1S/step)

Default: OFF

TRX 1S - TRX 10S: Broadcast audio is resumed 1 to 10 seconds after the received signal drops or your Transmission ends

HOLD: Broadcast audio is not resumed after the receive signal drops or your transmission ends.

TX 1S - TX 10S: Broadcast audio is resumed 1 to 10 seconds after your Transmission ends. Audio is resumed immediately when the received signal drops.

Set Mode Item 85 [TEMP]

Function: Indicates the current temperature inside the transceiver's case and selects the measurement units ("°F" or "°C") for the temperature sensor.

Press the [MODE] key to toggle the measurement units between "°F" and "°C".

SET (MENU) MODE

Set Mode Item 86 [TN FRQ]

Function: Setting of the CTCSS Tone Frequency.

Available Values: 50 standard CTCSS tones

Default: 100.0 Hz

CTCSS TONE FREQUENCY (Hz)					
67.0	69.3	71.9	74.4	77.0	79.7
82.5	85.4	88.5	91.5	94.8	97.4
100.0	103.5	107.2	110.9	114.8	118.8
123.0	127.3	131.8	136.5	141.3	146.2
151.4	156.7	159.8	162.2	165.5	167.9
171.3	173.8	177.3	179.9	183.5	186.2
189.9	192.8	196.6	199.5	203.5	206.5
210.7	218.1	225.7	229.1	233.6	241.8
250.3	254.1	–	–	–	–

Set Mode Item 87 [TOT]

Function: Setting of the TOT time

Available Values: OFF/0.5M - 10.0M (0.5M/step)

Default: 3.0M (3 minutes)

The time-out timer shuts off the transmitter after continuous transmission of the programmed time.

Set Mode Item 88 [TS MUT]

Function: Enables/Disables the receiver audio output while the Tone Search Scanner is activated.

Available Values: ON/OFF

Default: ON

Set Mode Item 89 [TS SPD]

Function: Selects the Tone Search Scanner speed.

Available Values: SLOW (1.25 tone/sec)/FAST (2.5 tone/sec)

Default: FAST

Set Mode Item 90 [VFO MD]

Function: Selects or disables the VFO band edge limiting for the current band.

Available Values: ALL/BAND

Default: BAND

BAND: When the VFO frequency reaches the high band edge of the current band, the VFO frequency will jump to the low band edge of the current band (or vice versa).

ALL: When the VFO frequency reaches the high edge of the current band, the VFO frequency will jump to the low band edge of the next band (or vice versa).

Set Mode Item 91 [VFO.SKP]

Function: Set the My Band.

Available Values: ON/OFF

Default: OFF

The “My Band” feature allows you to select several operating bands, and make only those bands available for selection via the [BAND] key.

ON: Only the bands that are turned on will be shown when pushing the [BAND] key.

OFF: When the [BAND] key is pressed, the bands that are turned “OFF” will not be shown. See page 100 for details.

SET (MENU) MODE

Set Mode Item 92 [VOL MD]

Function: Select the **DIAL** knob function.

Available Values: NORMAL/AUT.BCK

Default: NORMAL

NORMAL: The [**VOL**] key keeps the status while pressing the [**VOL**] key.

AUT.BCK: The [**VOL**] key to keep the status approximately three seconds after pressing the [**VOL**] key.

Set Mode Item 93 [WAKEUP]

Function: Setting of the Wakeup feature.

Available Values: OFF/5SEC - 60SEC(5SEC/step)/EAI

Default: OFF

Set Mode Item 94 [WX ALT]

Function: Enables/Disables the NOAA Weather Alert Feature.

Available Values: OFF/ON

Default: OFF

RESET PROCEDURES

In some instances of erratic or unpredictable operation, the cause may be corruption of data in the microprocessor (due to static electricity, etc.). If this happens, resetting of the microprocessor may restore normal operation. Note that all memories will be erased if you do a complete microprocessor reset, as described below.

MICROPROCESSOR RESETTING

To clear all memories and other settings to factory defaults:

1. Turn the radio off.
2. Press and hold in the **[MODE]** and **[V/M]** keys while turning the radio on.
3. Press the **[F/W]** key momentarily to reset all settings to their factory defaults (press any other key to cancel the Reset procedure).

SET MODE RESETTING

To reset the Set Mode Item* settings to their factory defaults:

1. Turn the radio off.
2. Press and hold in the **[BAND]** and **[V/M]** keys while turning the radio on.
3. Press the **[F/W]** key momentarily to reset the Set (Menu) mode settings to their factory defaults (press any other key to cancel the Reset procedure).

※: Except the following Set Mode Items

3: ANT.ATT, 10: BEL.SEL, 11: BNK.NAM, 18:CLK.SFT, 19: CW ID,
24: DCS CD, 28: DT SEL, 32: EMG.SEL, 35: HLF.DEV, 38: INT CD,
41: INT.SEL, 49: MR DSP, 52: MRNAME, 54: MRSKIP, 55: MSG.LST,
56: MSG.REG, 57: MSG.SEL, 61: PAG.CDR, 62: PAG.CDT, 68: RPT,
69: RPT.SFT, 79: SQ TYP, 80: SQSMTR, and 86: TN FRQ

SPECIFICATIONS

General

Frequency Ranges:	RX 0.5-1.8 MHz (AM Broadcast) 1.8-30 MHz (SW Band) 30-76 MHz (50 MHz HAM) 76-108 MHz (FM Broadcast) 108-137 MHz (Air Band) 137-174 MHz (144 MHz HAM) 174-222 MHz (VHF TV) 222-420 MHz (ACT1) 420-470 MHz (430 MHz HAM) 470-800 MHz (UHF TV; USA Cellular Blocked) 800-999.99 MHz (GEN2; USA Cellular Blocked) TX 144-148 MHz or 144-146 MHz 430-450 MHz or 430-440 MHz
Channel Steps:	5/9/8.33/10/12.5/15/20/25/50/100 kHz
Frequency Stability:	±5 ppm (+14 °F to +122 °F [-10 °C to +50 °C])
Repeater Shift:	±600 kHz (144 MHz) ±1.6/(5.0)/7.6 MHz (430 MHz) (5.0 MHz: USA)
Emission Type:	F2D, F3E, F2A
Antenna Impedance:	50 Ω
Supply Voltage:	Nominal: 3.7 V DC, Negative Ground Operating: 3.7 ~ 7.0 V, Negative Ground (EXT DC Jack) 5.0 ~ 7.0 V, Negative Ground (EXT DC Jack w/Charging)
Current Consumption:	120 mA (Receive) 60 mA (Standby, Saver Off) 30 mA (Standby, Saver On, Save Ratio 1:2) 50 mA (Radio Band Receive) 100 μA (Auto Power Off) 1.3 A (1.5 W Tx , 144 MHz) 3.7 V DC 1.6 A (3 W Tx , 144 MHz) 6 V DC 1.2 A (1 W Tx , 430 MHz) 3.7 V DC 1.8 A (2 W Tx , 430 MHz) 6 V DC
Operating Temperature:	-4 °F to +140 °F (-20 °C to +60 °C)
Case Size (W x H x D):	1.9" x 3.2" x 0.9" (47 x 81 x 23 mm) W/O knob & antenna
Weight (Approx.):	4.6 oz (130 g) With FNB-82LI & antenna

Specifications are subject to change without notice, and are guaranteed within the 144 and 430 MHz amateur bands only. Frequency ranges will vary according to transceiver version; check with your dealer.

Transmitter

RF Power Output:	1.5 W (@ 4.5 V AA x 3 or 3.7 V FNB-82LI 144 MHz) 3 W (@ 6 V or EXT DC 144 MHz) 1 W (@4.5 V AA x 3 or 3.7 V FNB-82LI 430 MHz) 2 W (@ 6 V or EXT DC 430 MHz) Low 0.1 W (@ 4.5 V AA x 3 or 3.7 V FNB-82LI) Low 0.3 W (@ 6 V or EXT DC)
Modulation Type:	Variable Reactance F2D , F3E, F2A
Maximum Deviation:	±5 kHz (F2D , F3E)
Spurious Emission:	At least 60 dB below (HIGH) At least 50 dB below (LOW or less than 1 W)
Microphone Impedance:	2 k Ω

Receiver

Circuit Type:	AM, NFM: Double-Conversion Superheterodyne WFM: Triple-Conversion Superheterodyne AM Broadcast/FM Broadcast: Single-Conversion Superheterodyne
Intermediate Frequencies:	1st: 47.25 MHz (AM, NFM) 1st: 45.8 MHz (WFM) 1st: 130 kHz (AM Radio/FM Radio) 2nd: 450 kHz (AM, NFM) 2nd: 10.7 MHz (WFM) 3rd: 1 MHz (WFM)
Sensitivity:	4 μ V for 10 dB SN (0.5-1.8 MHz, AM Broadcast) 3 μ V for 10 dB SN (1.8-30 MHz, AM) 0.35 μ V TYP for 12 dB SINAD (30-54 MHz, NFM) 1 μ V TYP for 12 dB SINAD (54-76 MHz, NFM) 1.5 μ V TYP for 12 dB SINAD (76-108 MHz, FM Broadcast) 1.5 μ V TYP for 10 dB SN (108-137 MHz, AM) 0.2 μ V for 12 dB SINAD (137-140 MHz, NFM) 0.16 μ V for 12 dB SINAD (140-150 MHz, NFM) 0.2 μ V for 12 dB SINAD (150-174 MHz, NFM) 1 μ V TYP for 12 dB SINAD (174-225 MHz, NFM) 0.5 μ V for 12 dB SINAD (300-350 MHz, NFM) 0.2 μ V for 12 dB SINAD (350-400 MHz, NFM) 0.18 μ V for 12 dB SINAD (400-470 MHz, NFM) 1.5 μ V for 12 dB SINAD (470-540 MHz, WFM) 3 μ V TYP for 12 dB SINAD (540-800 MHz, WFM) 1.5 μ V TYP for 12 dB SINAD (800-999.99 MHz, NFM) (USA Cellular Blocked)
Selectivity:	NFM, AM: 12 kHz/35 kHz (-6 dB /-60 dB) WFM: 200 kHz / 300 kHz (-6 dB/-20 dB)
AF Output:	50 mW @ 8 Ω for 10 % THD (@ 3.7 V) 100 mW @8 Ω for 10 % THD (@ 6 V)

FCC NOTICE

1. Changes or modifications to this device that are not expressly approved by YAESU could void the user's authorization to operate this device.
2. This device complies with part 15 of the FCC Rules. Operation is subject to the following two conditions: (1) This device may not cause harmful interference, and (2) this device must accept any interference including received, interference that may cause undesired operation.
3. The scanning receiver in this equipment is incapable of tuning, or readily being altered, by the User to operate within the frequency bands allocated to the Domestic public Cellular Telecommunications Service in Part 22.

DECLARATION BY MANUFACTURER

The Scanner receiver is not a digital scanner and is incapable of being converted or modified to a digital scanner receiver by any user.

WARNING: MODIFICATION OF THIS DEVICE TO RECEIVE CELLULAR RADIOTELEPHONE SERVICE SIGNALS IS PROHIBITED UNDER FCC RULES AND FEDERAL LAW.

YAESU



Declaration of Conformity

We, YAESU UK LTD. declare under our sole responsibility that the following equipment complies with the essential requirements of the Directive 1999/5/EC and Directive 2011/65/EU.

Type of Equipment:	FM Transceiver
Brand Name:	YAESU
Model Number:	VX-3E
Manufacturer:	YAESU MUSEN CO., LTD.
Address of Manufacturer:	Tennozu Parkside Building, 2-5-8 Higashi-Shinagawa, Shinagawa-ku, Tokyo 140-0002 Japan

Applicable Standards:

This equipment is tested and conforms to the essential requirements of directive, as included in following standards.

Radio Standard:	EN 301 783-2 V1.2.1
EMC Standard:	EN 301 489-1 V1.9.2 EN 301 489-15 V1.2.1
Safety Standard:	EN 60065:2002 +A1:2006 +A11:2008+A2:2010 +A12:2011
RoHS2 Standard:	EN 50581:2012

The technical documentation as required by the Conformity Assessment procedures is kept at the following address:

Company: Yaesu UK Ltd.
Address: Unit 12, Sun Valley Business Park, Winnall Close, Winchester
Hampshire, SO23 0LB, U.K.

Disposal of your Electronic and Electric Equipment

Products with the symbol (crossed-out wheeled bin) cannot be disposed as household waste. Electronic and Electric Equipment should be recycled at a facility capable of handling these items and their waste byproducts.

In EU countries, please contact your local equipment supplier representative or service center for information about the waste collection system in your country.



Attention in case of use

This transceiver works on frequencies which are not generally permitted.

As for the actual usage, the user has to possess an amateur radio licence.

Usage is allowed only in the frequency bands which are allocated for amateur radios.

List of national codes						
AT	BE	BG	CY	CZ	DE	
DK	ES	EE	FI	FR	GB	
GR	HR	HU	IE	IT	LT	
LU	LV	MT	NL	PL	PT	
RO	SK	SI	SE	CH	IS	
LI	NO	-	-	-	-	

YAESU

The radio

Copyright 2016
YAESU MUSEN CO., LTD.
All rights reserved.

No portion of this manual may be reproduced
without the permission of
YAESU MUSEN CO., LTD.



1601I-GM-1

Printed in Japan



E H O 2 8 M 2 1 1