

WRFS-X



The Bible

WIRES X – The Bible

Dedications

This book is dedicated to all the people in the MNWIS Fusion Room; especially to Chuck, Chris, Pete and Koy... the inspiration for the endeavor.



I would like to give a special dedication to my best friend Lunetta, for forgiving me for not playing ball with her while working on this project. Oh yes...and Jac for making think about my Lunetta.

WIRES X – The Bible

Copyright

Copyright (c) 2016 by WB7OEV, K9EQ, and HamOperator.com

Permission is hereby granted, free of charge, to any person obtaining a copy of this document to use, modify, copy, and post links to the Document at HamOperator.com subject to the following conditions:

, copy, modify, merge, publish, distribute, sublicense, and/or sell copies of the Software, and to permit persons to whom the Software is furnished to do so, subject to the following conditions:

- The above copyright notice and this permission notice shall be included in all copies or substantial portions of the Document.
- The Document shall not be posted to an Internet web site. (The Document is dynamic and constantly being updated. Posting it to another site would result in old versions hanging around and thus decrease the benefit of the Document to the Amateur Radio community.) Instead, please post a link to the document at HamOperator.com – the official distribution site. The URL is: http://www.hamoperator.com/Fusion/FusionFiles/WB7OEV-Fusion-PDF-0018_WiRESX-Install.pdf and will not change.
- Suggestions for improvements to the Document are welcome and can be sent to suggestions at HamOperator dot com.

THE DOCUMENT IS PROVIDED "AS IS", WITHOUT WARRANTY OF ANY KIND, EXPRESS OR IMPLIED, INCLUDING BUT NOT LIMITED TO THE WARRANTIES OF MERCHANTABILITY, FITNESS FOR A PARTICULAR PURPOSE AND NONINFRINGEMENT. IN NO EVENT SHALL THE AUTHORS OR COPYRIGHT HOLDERS BE LIABLE FOR ANY CLAIM, DAMAGES OR OTHER LIABILITY, WHETHER IN AN ACTION OF CONTRACT, TORT OR OTHERWISE, ARISING FROM, OUT OF OR IN CONNECTION WITH THE SOFTWARE OR THE USE OR OTHER DEALINGS IN THE DOCUMENT.

WIRES X – The Bible

Revision History

Table 1 Revision History

Revision	Description
2016-06-20	Initial Draft published to HamOperator.com during the Fusion net
2016-06-22	Add chapter on WIRES X Remote control – WB7OEV
2016-06-23	Added Forward (bio and goals) – WB7OEV
2016-06-24	Some Editing of text and add section of FT2D power setting method – WB7OEV
2016-06-29	Add cover sheet, Editing – WB7OEV
2016-07-02	Added Control node Repeater to Appendix –WB7OEV
2016-07-03	Dedications – WB7OEV
2016-07-07	Added more caption to figures – Formatted for Ebook –WB7OEV
2016-07-19	Update Etiquettes – highlighted linked delay Added RF Linked Repeater settings example in appendix – WB7OEV
2016-07-19	Added Manual Static GPS setting to appendix and procedure for FT1(X)D – WB7OEV
2016-07-20	Added manual static GPS setting for FT2D – WB7OEV Added manual static GPS setting for FTM-100DR – WB7OEV
2016-07-21	Added manual static GPS setting for FTM-400DR – WB7OEV Added manual static GPS setting for FT-991 – WB7OEV

WIRES X – The Bible

Or Everything You Think You Want to Know?

What's this book is all about

Who am I? ... My name is Dewey L. Hee, WB7OEV. In my prior life I was a System Administrator working for the Boeing Company and have done so for 38 years. I became interested in Amateur Radio while working for the Boeing Company in 1972; I started out with a Technician class License and did not do anything with it at first. After a couple years I started to get into the hobby when my professional career and the hobby started to merge. That merging caused me to upgrade to a General Class License and eventually upgrade to Advance Class License. I had participated in the Public side of the hobby (ARES) and experimented with packet radio in its early days. But, things had to end, I got married and had a family eventually had to drop out of the hobby and concentrate on my career until I retired in 2010. After retiring I found myself with time on my hands so I had to find something to do, since the family is now on their own.

I had maintained my license and was looking around on Amazon one day and saw a Baofeng Radio for a few bucks; that what got me back into the hobby. After working with the Baofeng for a few days, I realized the Baofeng had some shortcomings so I ordered another radio, Yaesu's VX-3R. Like an idiot, I didn't read all the specs (I just like it small size) and found it lack power to work a repeater that I wanted to work. So I started looking to purchase another radio and came to like the FTM 400. I finally had the power I needed to work the repeater.

I began to wonder what else I could do with the FTM 400 and discovered this mode call Fusion, (C4FM) and I got bitten with the desire to get back into digital radio, Yaesu style. The more I looked into this so called WIRES X, the more I became intrigued. Before I knew it, I acquired more radios to experiment with and eventually ended up with a WIRES X Repeater.

I started listening in on the WIRES X Network and eventually ended up in the MNWIS-Fusion Room. I started listening to the Net and found that there were a number of others that were pretty knowledgeable on WIRES X and where I gained a lot of information. As I gain more knowledge of WIRES X, I found that there wasn't a single source for information on the subject. As I participated in the MNWIS-Fusion Room Net; I found that there were others that also needed information on WIRES X. I found that there are three individuals that seem to know; and is the foundation of the knowledge base for the MNWIS-Fusion Room.

As I listened to the MNWIS Fusion net, there didn't seem to be a single source of information on WIRES X...well, if you don't count Yaesu. Even Yaesu didn't seem to have single sources of

WIRES X – The Bible

information. All the information seems to be scattered all over the place; so I started collect this information to put in a single document for myself and others that are interested.

Chris Petersen, K9EQ, Charles (Chuck) Howard, K0ORK and Pete Clyne, AD0MI are the architects and the knowledge base of the MNWIS-Fusion room. These gentlemen seem to have the most of the information about WIRES X; Because of this knowledge base, the Community of the MNWIS-Fusion Room became my inspiration for creating WIRES X –The Bible.

My goal for creating this document (which has grown into a book); is to provide a central point access for some, if not all, WIRES-X information, procedures and best practices on the uses of Fusion WIRES-X for all to use.

The purpose of this book is;





- 1) To provide a common source for WIRES-X, gather information from Yaesu's Manuals, experiences from the Amateur Radio Community, and the best practices from both the Amateur Radio Community and the Bakken Amateur Radio Society.
- 2) To provide a platform for learning, experimentation, and advancement of Amateur Radio skills and art. A platform of Discovery...And to have FUN!
- 3) To encourage networking, sharing, and exchange of "interesting" technical information of WIRES X, where people are encouraged to help each other out.

Dewey L Hee

WB7OEV

WIRES X – The Bible

Table of Contents

COPYRIGHT	3
REVISION HISTORY.....	4
WHAT’S THIS BOOK IS ALL ABOUT	5
WHAT IS WIRES X?	12
TERMINOLOGY (AS DEFINED IN THE YAESU FT1DR WIRES X MANUAL).....	14
THE ELEMENTS OF WIRES X.....	16
Local Node.....	16
Gateway	17
Repeaters	19
RF Linked Repeater	20
WIRES X Repeater	21
USING WIRES X.....	22
FT1D and the FT1XD 	22
FT2D 	23
FTM 100DR 	24
FTM 400 	25
FTM 3200 	27

WIRES X – The Bible



FTM 991 ALL-BANDS, MULTIMODE PORTABLE TRANSCEIVER 28

RECEIVING AND TRANSMITTING WIRES X..... 29

Additional Uses for the  Key on the Transceiver 30

THE FT1(X)D 31

Connecting to a local Node on the FT1(X)D 31

Search for a node or room from the transceiver lists on the FT1(X)D 32

Search & Direct on the FT1(X)D..... 34

Connecting to previously connected Room or Node on the FT1(X)D 35

Using the DTMF ID to connect to a Room on the FT1(X)D 36

THE FT2D 37

Connect to local node using the FT2D 37

Supplemental Screen information of FT2DR 39

Connecting to a node or room on the Internet using the FT2D 40

Searching for node or room from a list using the FT2D 40

Searching by the node or room name using the FT2D 42

Connect to a node or room that you were most recently connected 44

Specifying the DTMF ID of the node or room to connect..... 44

Tip: Power Setting in WIRES X..... 47

CONNECTION WIRES X USING AN FTM 100DR 49

Connecting to a the local node 49

Connecting to a node or room on the Internet using a FTM 100DR..... 51

Searching by node or room name 52

Connecting to the room you have most recently connected 53

Specify the DTMF ID of the node or room you want to connect to 54

WIRES X – The Bible

CONNECTION WIRES X USING AN FTM 400DR	55
Connecting the FTM 400DR in Digital Mode.....	55
Connecting to a node or room on the Internet using the FTM 400DR	58
Searching by node or room name using the FTM 400DR	60
Connecting to the node of room you have most recently connected using FTM 400DR	62
Specifying the DTMF ID of the desired node or room.....	62
THE FT-991.....	63
Connecting to a Local Node in Digital Node on the FT-991	63
Searching from the node or room list	66
Search by Node or Room Name using the FT-991	67
Reconnecting to the most recently connected Room or Node	69
Specifying the DTMF ID of the Room or Node to Connect to.....	70
Disconnecting from a node or room on the FT-991	72
Summary	72
Room Disconnect for the various Yaesu C4FM Radios.....	73
FT1D and FT1XD Disconnect.....	73
FT2D Disconnect.....	73
FTM-400DR Disconnect	73
Summary	74
HOW TO SET UP A WIRES X NODE (WB70EV STYLE)	75
PC Preparation.....	76
Limit the number of programs to run at start up.	77
Turn off Cortana	78
Turn off visual effects.....	79
Disable the PIPO WIFI Adapter and Enabling the Ethernet Adapter	81
Assign a Static IP to the WIRES X PC.....	83
Internet Connection (Port forwarding) specifically related to Actiontec FIOS Router.....	89
Prepping the radio (FTM-100)	91
Prepping the HRI-200.....	92

WIRES X – The Bible

Connecting it all up	92
Installing the WIRES X Software.....	95
Configuring the WIRES X Software.....	98
Suggested Local Node Setting	102
WIRES X ETIQUETTES.....	107
WIRES-X REMOTE CONTROL.....	111
WIRES X PORT INFORMATION (ADDITIONAL INFORMATION).....	117
PORT ROUTING (OPENING) SETTING TO THE ROUTER.....	124
WIRES X TERMINOLOGY USE BY THE AMATEUR COMMUNITY.....	126
SETTING THE DSQ CODE.....	127
FINDING A LOCAL NODE.....	133
REFERENCES.....	134
APPENDIX.....	135
What is DSQ?	135
RF Linked Repeaters Parameters	136
WIRES X Repeater (Control Node Repeater)	138
Procedure to put the DR1X/XE into HRI-200 mode	151
Static GPS entry for Fusion Radios	153
Entering the Static GPS for the FT1(X)D	156
Entering the Static GPS for the FT2D	159
Entering the Static GPS for the FTM 100DR.....	162
Entering the Static GPS for the FTM 400DR.....	164

WIRES X – The Bible

WIRES X – The Bible

What is WIRES X?

WIRES X (Wide-coverage Internet Repeater Enhancement System) is digital communication developed by **Yaesu** to further the interest of the Amateur Radio Communication. It uses a form of VOIP (Voice over IP) to connect Amateur Radio Station utilizing the Internet. It supports the new C4FM Digital Communication mode. C4FM digital signals are repeated without deterioration of audio and data communications and sent over the Internet to Amateur Radio Stations.

WIRES X uses local Node (station connected to the Internet via a PC) as access points which repeats the communications of conventional Amateur Radio Stations (shown in Figure 1).

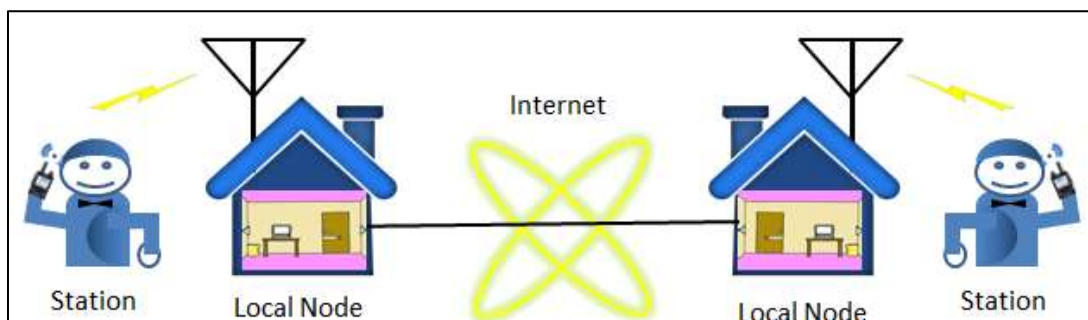

Figure 1 Stations and Nodes connected via the Internet

An amateur Radio operator calls a local Node's radio which is connected to the Internet via a PC. The local Node radio relays the amateur's call to the Internet via the PC. The PC relay the amateur call to another Node's PC that is also connected to the Internet, then send it to the Node radio. Then local Node radio then relays the call to the receiving amateur radio station.

WIRES X – The Bible

When the local Nodes are connected to each other via the Internet, Amateur Radio Stations all over the Globe can communicate with each other just by connecting a conventional station to the local Node (see Figure 2 showing the relationship between Nodes on a WIRES X Global Network).

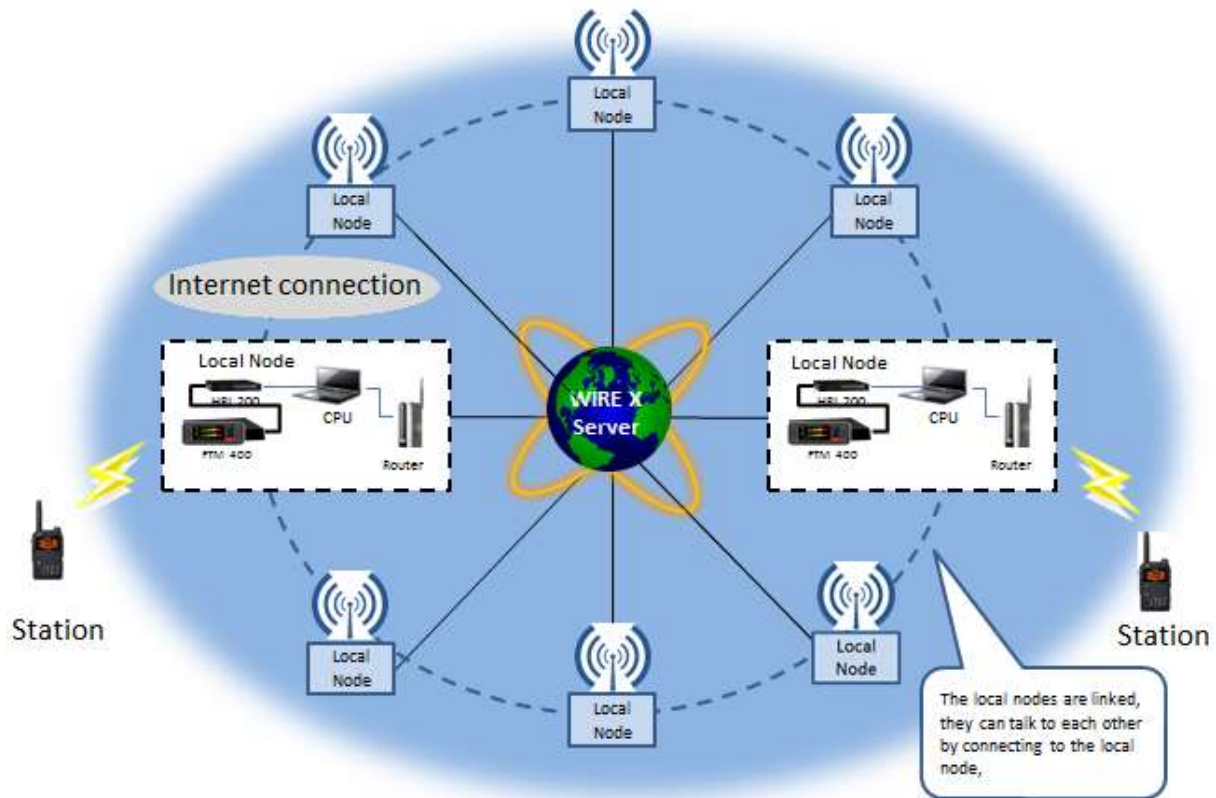

Figure 2 WIRES X Local Nodes linked to other Nodes globally

WIRES X also supports digital communications which can transmit and receive digitized data, e.g. text, image and audio on the same Global Network. The WIRES X Network extends the reach of an Amateur Station located in Seattle to an Amateur Station located in Japan or somewhere in Europe. This can be accomplished by using just a hand held radio connecting to a local Node then onto the distant Node then to the destination amateur radio station.

This is a brief explanation of the WIRES X Network.

WIRES X – The Bible

Terminology (As defined in the Yaesu FT1DR WIRES X Manual)

There are a few terms that must be clarified in order to understand WIRES X. These are listed in the following;

- **Node**

Radio repeater connected to the Internet via a PC, which repeats communications of a conventional amateur radio as an access point.

- **Local Node**

This is a Node within the radio communication range of a conventional amateur radio station.

- **Analog Node**

A Node that is a transceiver or repeater using a conventional FM format and can only repeat DTMF (Dual Tone Multi Frequencies) codes and analog audio transmission/receptions.

- **Digital Node**

This is a Node which is a transceiver or repeater compatible with digital communications in **C4FM** (Continuous 4 Level FM) format. With this type of Node you can not only relay voice communications, but also text and image data transmissions. One can also repeat DTMF codes and audio transmissions/Receptions.

- **Convention Amateur Station**

This is a normal Amateur Radio station either an individual on a hand held radio, a mobile radio and a base station.

- **Room**

This is a WIRES X Network community space to which multiple Nodes can connect simultaneously, like the old telco party Line. This is a place where all amateur stations can link to each other via local Node and communicate with each other. In addition to voice communication, one can chat with text messages on the PC use for the local Node.

- **WIRES X user ID (node)**

YAESU provide identification name with the WIRES X node. Each node is assigned a DTMP ID (5-digit number, e.g. 11916) and user ID (alphanumeric e.g. WB7OEV) up to 10 digits in length provided. Knowing the ID of the node to connect to, you can transmit

WIRES X – The Bible

the DTMF ID code from the transceiver, specifying the node to connect to by searching by characters.

- **ID List**

Nodes and room which currently operating WIRES are listed and published on the Yaesu website. The website shows information such as IDs, the call sign and the operating frequency of the node.

WIRES X – The Bible

The Elements of WIRES X

WIRES X stations are local Nodes, Gateways, and Repeaters that make up the WIRES X Network. These stations are connected to the internet via PCs which converts the signal to digital packets and then relays that packet to other station using the internet. In the WIRES X Network, there are three types of WIRES X Stations and they are as follows;

Local Node

The Local Node is a personal Amateur Radio Station (usually a base radio station) operating on a VHF/UHF simplex frequency, linked to a PC that's connected the internet. This is what a Conventional Amateur Station uses to link to the WIRES X Network.

The following are the base components of WIRES X; this is a station that's configured with the following;

- A Node Radio which a Radio that supports C4FM, such as Yaesu FTM 100 or the FTM 400.
- A HRI-200 WIRES X Interface.
- A dedicated PC running Windows 7 or better
- WIRES X PC Software Ver. 1.120 installed on the PC.
- An Internet Connection (6 MBps or better)

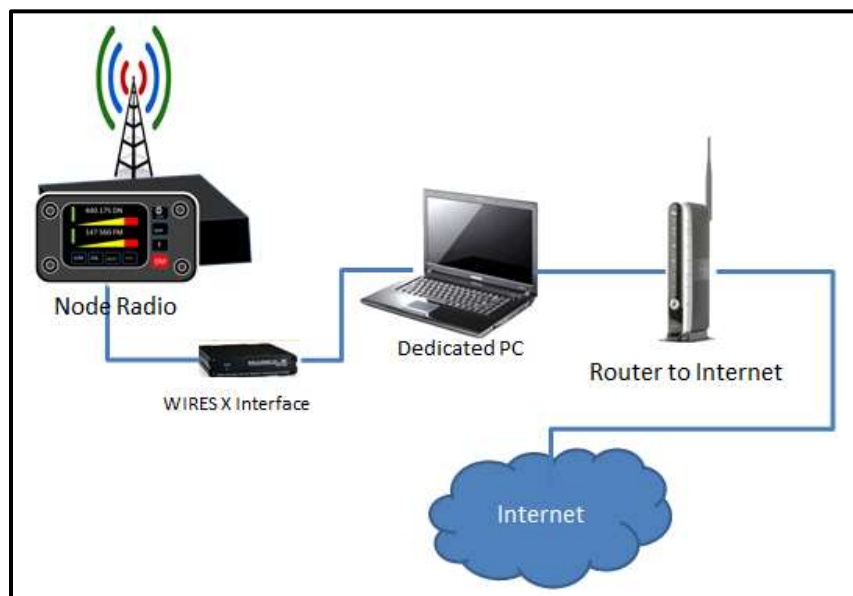

Figure 3 a typical Local Node configuration

Figure 3 shows a typical Local Node and its components. This is what it is needed to create the Local Node.

WIRES X – The Bible

Gateway

The Gateway is Local Node that is used by a group of Nodes, Repeaters and amateur radio stations. That's where a Local Node is linked to WIRES X Network and becomes a point of entry.

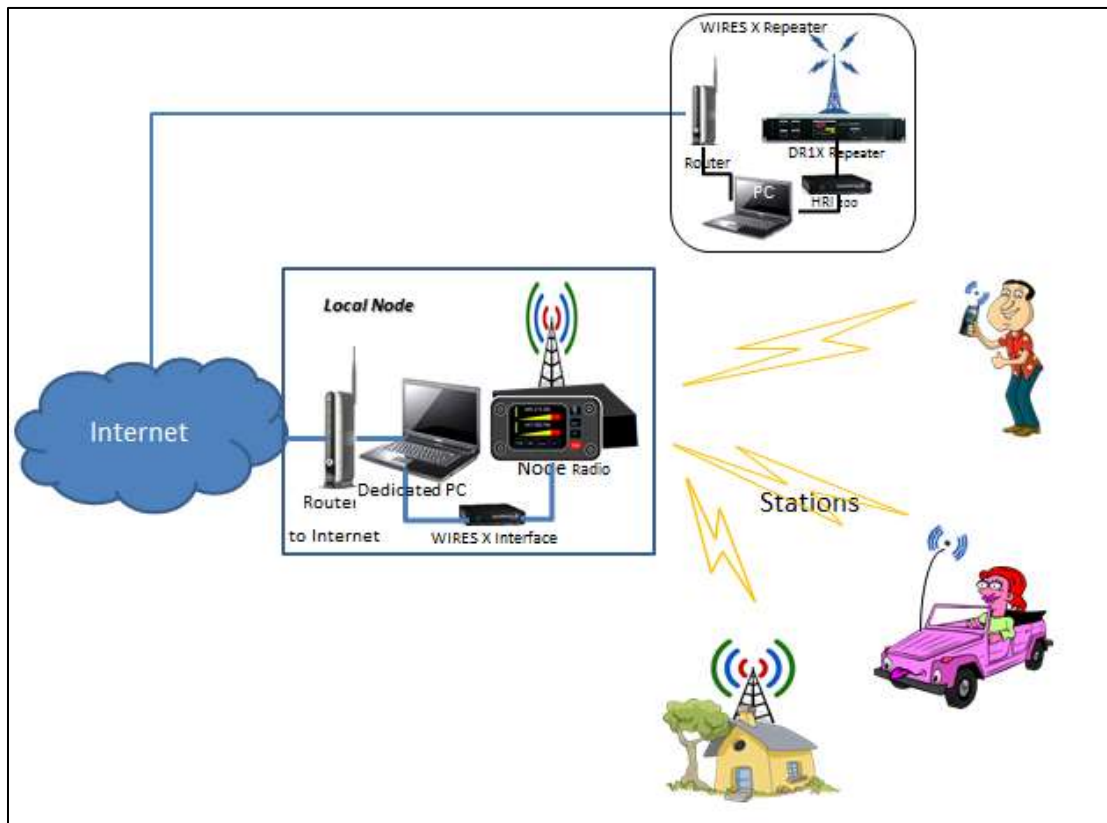

Figure 4 WIRE X Gateway

Figure 4 shows the Gateway relationship between stations, Nodes and repeaters. Any Node can become a gateway if it becomes the only way for a number of conventional amateur radio stations to connect to WIRE X. Repeater can also become a gateway to the WIRE X Network.

Gateways are also linked to a Room in the WIRE X Network where Amateur Stations congregate on the WIRE X System. Figure 5 shows the relationship between Nodes and rooms. Each Node also has a room associated with it (which may not be active). If the Node's Room is active...this allows other Nodes to connect to it. The room contains a number of Nodes within; not just a single Node. All Nodes within the room can communicate with each other. These rooms form a community of Nodes which allows any amateur station around the Globe to communicate with each other while in it.

WIRES X – The Bible

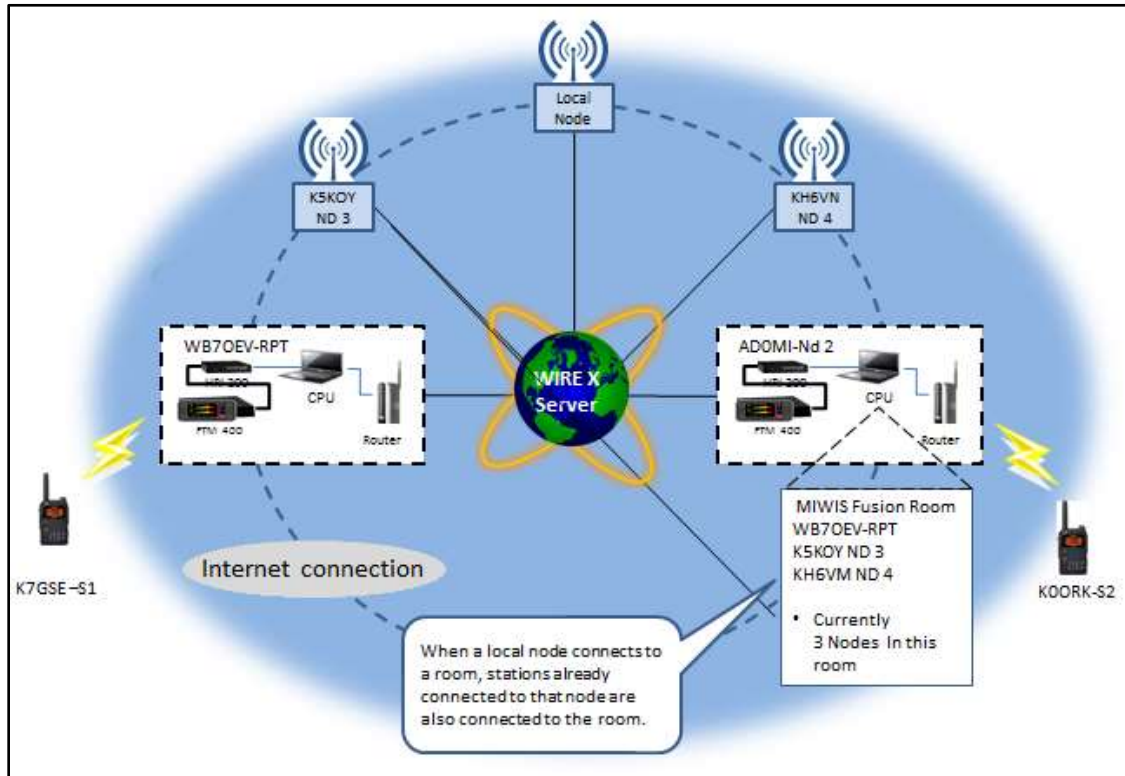

Figure 5 Nodes, Rooms

In Figure 5 the station K7GSE initiates a call through the local Node WB7OEV-RPT to the station KOORK...the local Node WB7OEV-RPT is linked to MIWIS Fusion Room located in the state of Minnesota. The Node AD0MI-ND is associated to the MIWIS Fusion Room and this room has a number of Nodes connected to it which includes the Node WB7OEV-RPT. The station KOORK is linked (via AD0MI Node) to the MNWIS-Fusion Room and hears the call from K7GSE and responds to create a conversation (QSO). Now a QSO between the two stations can take place. Any station that is connected to the MNWIS-Fusion Room can also listen in on the QSO take place between K7GSE and KOORK.

In this scenario the MNWIS-Fusion Room become a large Global Community. And AD0MI-ND becomes the Gateway for the MNWIS-Fusion Room on the WIRES X Network.

WIRES X – The Bible

Repeaters

A Repeater is a station that takes a signal on one frequency and retransmits on another frequency. In this way an amateur radio station uses the Repeater to extend its communication range to a distant amateur radio station. A Node linked to a repeater also increases the communication range. Repeaters are connected to the internet via a PC...linking repeaters to other Nodes and repeaters across the WIRES X Network. Repeaters are linked the Nodes, which in turn are linked to rooms. This relationship extends the range of Nodes utilizing the Internet as shown in figure 6.

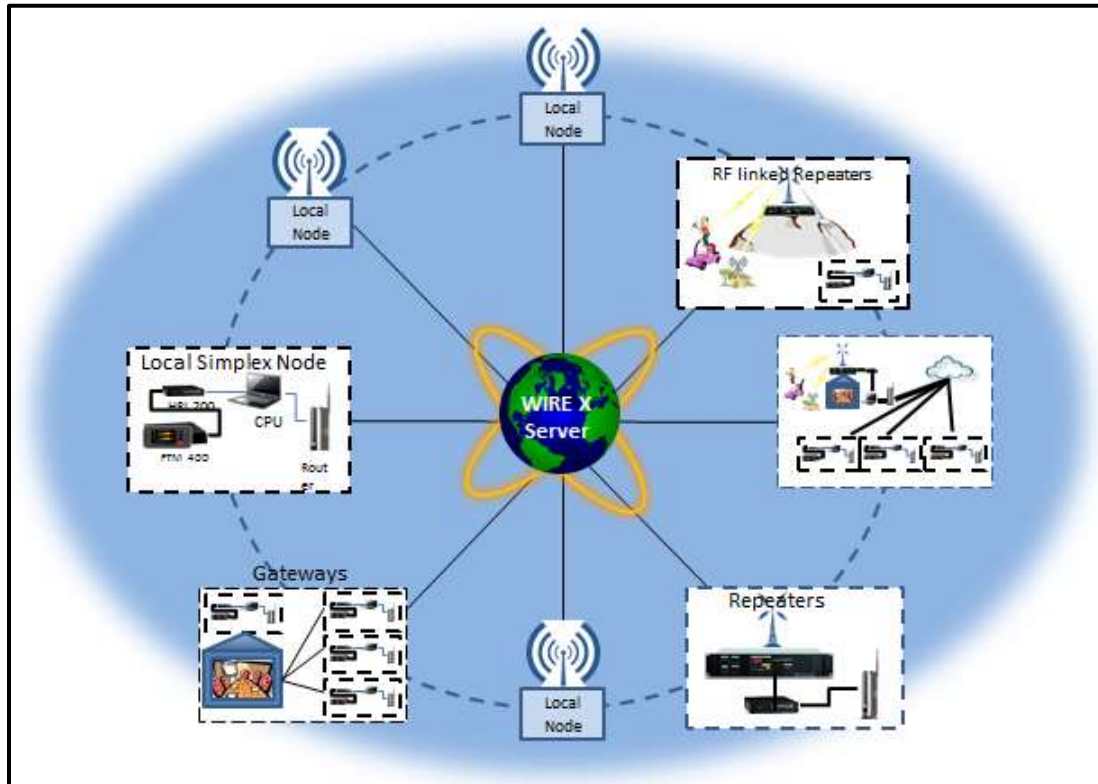

Figure 6 Repeater, Gateways and Node

There are two types of WIRES X repeaters.

1. Repeater that is linked to a Node via RF (**RF Linked Repeater**).

That is where a Local Node is linked via Radio Frequency (**RF**) to a remote repeater. Usually this is a repeater that does not have access to the internet

2. Repeaters that have a direct connection to the internet (**WIRES X repeater**).

The following illustrates the differences between the two types.

WIRES X – The Bible

RF Linked Repeater

A RF Linked Repeater is where a Local Node is connected to a Repeater that is remotely located (such as a mountain top) and does not have access to the Internet.

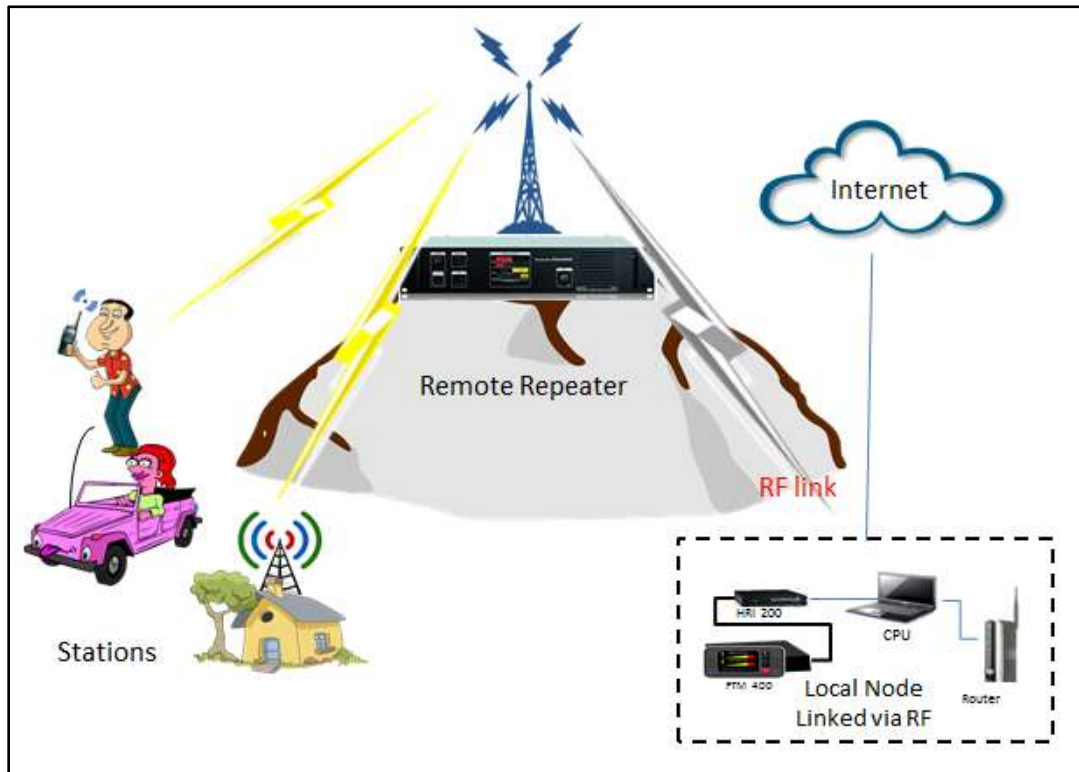

Figure 7 WIRES X RF Linked Repeater

Figure 7 shows a repeater that is in an environment that does not have access to an internet connection. The Local Node is in a location to where it has an internet connection.

The local Node is set to the repeater's frequencies and it becomes linked, via RF, to the remote repeater. The local Node becomes a conventional Amateur Station and relays any digital signal to and from all other station that use the repeater. The difference, the local Node connects to the internet, instead of a person in a conventional Amateur Station carrying on a QSO. The QSO are going out over the internet via the local Node. The Linked Repeater becomes a Gateway to the WIRES X Network.

WIRES X – The Bible

WIRES X Repeater

The WIRES X Repeater is a repeater that is in a location where access to the internet is available. The WIRES X interface, HRI-200 and a dedicated PC can be directly connected Repeater. The PC via the HRI-200 now becomes the controller for the DR1X repeater. The WIRES X repeater is connected to the internet through the PC/HRI-200 interface.

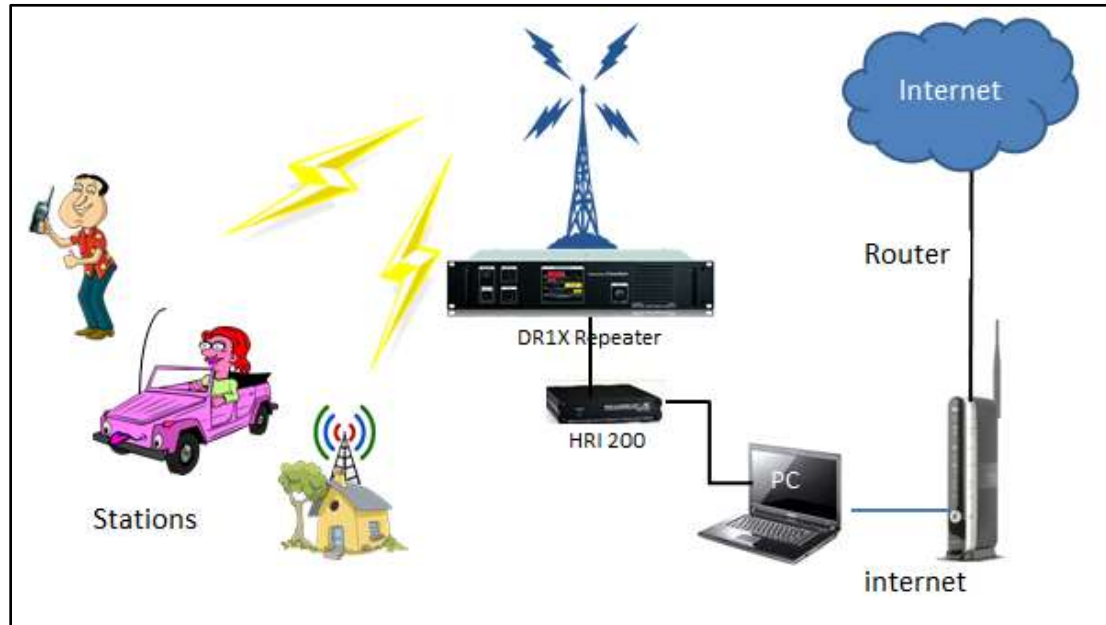

Figure 8 WIRES X Repeater

Figure 8 shows the HRI-200 interface connected to the DR1X repeater which is then connected to a PC. The PC is then connected to the Internet. The PC runs the Yaesu's WIRES X PC Software which is the controller for the DR1X repeater in addition relaying amateur station communication through to the Internet to other Nodes on the WIRES X Network. Similar to the RF Linked Repeater, the WIRES X repeater also becomes a Gateway to the WIRES X Network.

WIRES X – The Bible

Using WIRES X

In order to use WIRES X, you must have a radio that support the WIRES X protocol which is C4FM. These types of radios are made by YAESU.

The following is a list and brief description of the radios, (as derived from [Yaesu's Website](#)) that supports the WIRES X (C4FM).



FT1D and the FT1XD

The FT1D and FT1XD are hand held radios that operate on the Amateur Radio Bands. These radios are Dual-Band Radio...which operates on VHF and UHF bands on two VFOs (VFO A, VFO B).

Note: Digital communication on only support on VFO A only.

The FT1D and FT1XD provides three digital modes (DN-V D mode, VW-Voice FR mode, Data FR mode) and FM-Analog modes,

- **DN-V/D mode** is Voice and Data communication in the same time frame. This mode enables the transceiver to send voice data with GPS position data and ID data in the same time frame. Also, this mode can pass the voice data with strong error correction data to stabilize the digital communication. This mode will be the basic mode of C4FM FDMA Digital HAM radio.
- **VW-Voice FR mode** uses the full rate of data capacity for voice data. This mode enables you to transfer clear; high quality voice data. The Data FR mode uses the full rate of data capacity for transferring data. This mode enables the transfer large amounts of data, text messages, images, and voice memo data with double speed of that of V/D mode.
- **FM-Analog mode** is the same as current FM mode allowing you to communicate with all VHF/UHF HAM radio operators. Note: The FM mode is support on both VFOs.

WIRES X – The Bible



FT2D

The FT2D is hand held radio that operates on the Amateur Radio Bands. This radio is a Dual-Band Radio...which operates on VHF and UHF bands, on two VFOs (VFO A, VFO B). Unlike the FT1D and FT1XD, the FT2D supports digital modes on both VFOs in addition to FM.

The FT2D also has a 1.7-inch the high resolution touch screen display that provides information and access to features...providing touch-screen support functions and a high level of on-screen readability.

The FT-2DR operates in one of traditional FM analog mode and three digital modes.

DN V/D Mode (Simultaneous Voice/Data Communication Mode) which half of the bandwidth is used for voice signal with error correction and the other half use for GPS position data and ID data in the same time frame. The hand held uses powerful error correction technology developed for professional communication devices. The basic digital C4FM FDMA mode provides a good balance between sound quality and error correction.

VW Voice FR Mode (Voice Full Rate Mode). This mode uses the entire 12.5 kHz bandwidth to transmit digital voice data. The larger voice data size allows voice communication with high sound quality. In addition a high-speed data communication mode that uses the entire 12.5 kHz bandwidth for data communication. The hand-held automatically switches to this mode when sending and receiving images, allowing a large amount of data to be transmitted quickly.

FM Analog Mode is effective for communication with a weak signal that causes voices to break up in the digital modes. The analog mode allows communication even at distances where noise and weak signals make communication almost impossible. The tried-and-trusted low-power circuit design uses less battery power than the digital modes.

WIRES X – The Bible

FTM 100DR



The FTM-100DR is VHF/UHF Dual Band Transceiver. The FTM-100DR's single transmitter provides 50 solid Watts of RF power on both the 144 and 430 MHz amateur radio bands, while still being able to support both C4FM Digital and FM Analog communications

The FTM-100DR operates in three (3) Digital modes and an (1) Analog mode. This feature packed radio with Automatic Mode Select (AMS) function that instantly detects the received signal mode. The AMS function enables stress-free operation and eliminates the need to manually switch between communication modes.

The Operating modes are as follows;

- **DN-V/D Mode** (Voice/Data simultaneous communication mode). In the DN mode, digital voice signal is transmitted in half of the band width, while the other half of the 12.5 kHz band width channel is used for error correction of the voice signal and other data. By incorporating powerful error correction technology developed for communication devices, error correction codes provide the advantage of fewer interruptions to conversations over some distant. The Clear Voice technology developed for the C4FM FDMA Digital mode provides the ideal balance of error correction and sound quality.
- **VW-Voice FR mode** (Voice Full Rate Mode) uses the full 12.5 kHz bandwidth to transmit digital voice data. The increased amount of voice data permits high quality voice communication, sound quality for a “QSQ” with friends.
• **Data FR mode** (High Speed Data Communication Mode) is high-speed data communication mode uses the full 12.5 kHz bandwidth for data communication. The transceiver automatically switches to Data FR mode when transmitting snapshot pictures, and can be used to transmit large quantities of data at high speed.
- **FM-Analog** FM mode is effective when weak signal strength causes audio drop out in the digital mode, and enables communication up to the borderline of the noise level. Also the use of established Yaesu low power circuit designs provides greater efficiency than the digital modes. This is the typical FM mode used by most typical non-digital handhelds and VHF/UHF mobiles.

WIRES X – The Bible



FTM 400

The FTM-400DR is fully compatible for use on the YAESU WIRES X Network. Compared to other digital modulation schemes within FDMA, C4FM has excellent communication quality (BER: Bit Error Rate characteristics). C4FM is the standard method for communication devices that support FDMA.

The FTM-400 has big 3.5-inch full color and its touch panel operation. The icon symbols, multi-function key display and pop-up messages are all displayed in high-resolution color thanks to the full-color, high luminance TFT liquid crystal screen. Various operations are simply and easily executed by gently touching the screen.

The FTM-400DR operates in three (3) Digital modes and an (1) Analog mode to suit the needs when needed. The FTM-400DR is equipped with Automatic Mode Select (AMS) function that instantly detects the received signal mode. The AMS function enables stress-free operation and eliminates the need to manually switch between communication modes.

The FTM-400DR operating modes are;

- **DN-V/D Mode** The digital voice signal is transmitted in half of the band width while the other half of the 12.5 kHz band width channel is used for error correction of the voice signal and other data. By incorporating powerful error correction technology developed for professional communication devices, effective error correction codes provide the advantage of fewer interruptions to conversations. The Clear Voice technology developed for the C4FM FDMA Digital mode provides the ideal balance of error correction and sound quality.
- **VW-Voice FR mode (Voice Full Rate Mode)** mode uses the full 12.5 kHz bandwidth to transmit digital voice data. The increased amount of voice data permits high quality voice communication, the Data FR mode (High Speed Data Communication Mode) provides high-speed data communication mode uses the full 12.5 kHz bandwidth for data communication. The transceiver automatically switches to Data FR mode when transmitting snapshot pictures, and can be used to transmit large quantities of data at high speed.
- **FM-Analog FM mode** is effective when weak signal strength causes audio drop out in the digital mode, and enables communication up to the borderline of the noise level. Also the use of established Yaesu low power circuit designs provides

WIRES X – The Bible

greater efficiency than the digital modes. This is the typical FM mode used by most VHF/UHF mobiles.

WIRES X – The Bible

FTM 3200



The FTM-3200DR is a ruggedly built compact C4FM/FM **VHF 2-Meter** mobile transceiver, providing high output power of up to 65 Watts to ensure stable long-distance communications.

While the new FTM-3200DR incorporates new technology such as Automatic Mode Select (AMS). The AMS mode instantly recognizes whether a transmission is digital or analog, and appropriately switches the operating mode to allow the co-existence of both digital and analog users.

The Operating modes are;

- **DN-V/D Mode** The digital voice signal is transmitted in half of the band width while the other half of the 12.5 kHz band width channel is used for error correction of the voice signal and other data. By incorporating powerful error correction technology developed for professional communication devices, effective error correction codes provide the advantage of fewer interruptions to conversations. The Clear Voice technology developed for the C4FM FDMA Digital mode provides the ideal balance of error correction and sound quality.
- **FM-Analog** FM mode is effective when weak signal strength causes audio drop out in the digital mode, and enables communication up to the borderline of the noise level. Also the use of established Yaesu low power circuit designs provides greater efficiency than the digital modes. This is the typical FM mode used by most VHF/UHF mobiles.

NOTE: This radio operates on the **2 meter band only** and does not connect in WIRES X mode. You can only transmit and receive digital (**DN**) on a local Node that is already connected to a room.

WIRES X – The Bible



FTM 991 ALL-BANDS, MULTIMODE PORTABLE TRANSCIEVER

The FT-991 is an all band MF/HF/VHF/UHF transceiver with C4FM (System Fusion) Digital capability. The FT-991 includes multi-mode operation on CW, AM, FM, SSB, and Digital Modes (Packet, PSK31, RTTY and C4FM), with 100 Watts of HF/50 MHz Capability (50 Watts VHF/UHF).

The FT-991 high-resolution full color 3.5" TFT Touch panel for superior operability and visibility, incorporating a High Speed Spectrum scope with ASC (Automatic Spectrum-scope control) built right in.

The FT-991 supports the C4FM digital mode. This digital mode provides error correction and supports V/D mode (DN) which the FT-991 is able to transmit digital signals. It has AMS mode which recognizes the signal from another station and automatically switch to the correct mode (C4FM) digital or FM analog mode.

WIRES X – The Bible

Receiving and Transmitting WIRES X

In order to listen or to receive a WIRES X signal. One has to find a Local Node or a WIRES X Repeater within the range of your transceiver.

Basically all WIRES X Nodes are Amateur Radio Stations that are voluntarily registered with Yaesu. The Amateur Radio Station information such as their location and operating mode is listed in Yaesu Website; <https://yaesu.com/jp/en/wires-x/index.php>. You can use the Yaesu list to search for nearby local Nodes, and other Nodes on the internet use by Amateurs that you want to communicate with.

Once you find that there is a WIRES Node in your area...note its frequency and the DSQ code (if there's one).

Now you are ready to connect to a Local Node to experience WIRES X.

Use the following procedure to set up your transceiver to receive and transmit on a Local Node.

Note: You do not need to set the transceiver to WIRES X mode to use the Local Node.

For the your particular radio...if you have a dual band;

1. Set the radio to use **VFO A**.
2. Enter the frequency of the WIRES X Node.
3. Set the mode to “**DN**”.

Use the  key to change to the “**DN**” mode’.

Note: Pressing the  key repeatedly cycles thru the transceivers modes, e.g.

FM→**DN**→**VW**→**FM**



4. Set the **DSQ** code if needed

Hint: Set the DSQ code to BREAK and the radio will ignore the code.

At this point you are ready Received and Transmit using the Local Node or WIRES X Repeater on the frequency that you found.

WIRES X – The Bible

Additional Uses for the Key on the Transceiver

The  key is used to connect to a local Node in digital mode, in addition to selecting the communication mode of the transceiver. In this section we will discuss the use of the  key in the digital mode.

You can use the  key to connect to the Local Node.

NOTE: The  key can also be used to determine if there is a Local Node on the current frequency.

When you press the  key for over a second a flashing **X** symbol appears on the left of the frequency in the transceiver. The **X** symbol continues to flash until a node is found.

When a local node is found, the **X** symbol is lit solid; the node and city name appears on the lower part of a transceiver's screen.

If a node is not found within 5 minutes; the **X** symbol disappears and the transceiver's screen returns to normal.

Now that the transceiver is in the WIRES X digital mode you can do the following;

1. Search an accessible node or room from an internal list that you create on the transceiver
2. Specify the node or room by DTMF ID to connect to.
3. Specify the node or room by name to connect to
4. Selecting the most recently connected node or room

The following section shows how the  key is used by the Yaesu Radios described in the previous section.

WIRES X – The Bible

The following is a brief  procedure for the following Yaesu Radios;

The FT1(X)D

Connecting to a local Node on the FT1(X)D

1. Turn the DIAL to set VFO to the frequency of the desired local node.
2. Press the  key for over a second; **X** flashes, (left of the frequency displayed on the screen in figure 9).

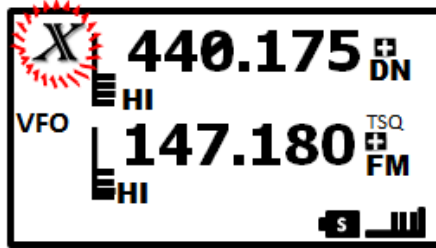

Figure 9 Searching for a node

When a local node is found, **X** is lit solid; the node and city name appears on the lower part of a transceiver's screen.

The following illustrates various stages the transceiver could connect to a Local Node.



Figure 10 Connected to Node (Main Screen of the WIRES X digital mode)

Figure 10 Shows connected to a local node, but unable to connect to an internet Node or Room (the FT1(X)D has never connected to a room on WIRES X Network).

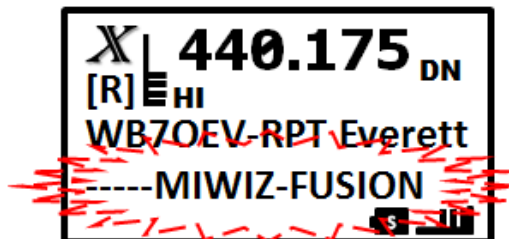

Figure 11 unable to connect to Internet Room

WIRES X – The Bible

Now Figure 11 shows connected to a Local Node but unable to connect to an internet Room (the room is blinking)...a room that was previously connected too. To connect to the flashing room press the **ENT** to connect to the room. Once connected, the Room stops flashing (figure 12).

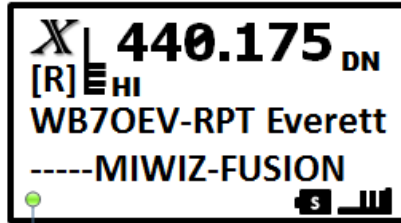

Figure 12 Connected to Room

Additional **DN** Functions of the FT1(X)D

Once connected to a local Node via the **DN** key, there are other function can be performed in one of the following ways.

- Search for node or room from the transceivers list
- Search for node or room name
- Connecting to the most recently connected node or room
- Specify the DTMF ID of the desired node or room

Search for a node or room from the transceiver lists on the FT1(X)D

1. The connection destination is displayed, press the **ENT** for over a second and the Menu list of the local node appears as follows;

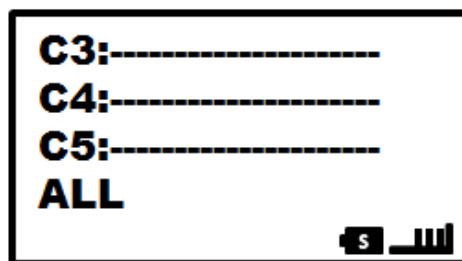

Figure 13 transceiver's Menu List

2. Turn **DIAL** to select [ALL] then press hold the **ENT** and all accessible nodes and rooms list appears. [Waiting] keep flashing until the list appears.

WIRES X – The Bible



Figure 14 Accessible nodes and rooms List

A List of Rooms is displayed and it shows Rooms and the number of node connected.

3. Turn the **DIAL** to select a room to connect.



Figure 15 Selected Rooms

4. Press **ENT** key, the **FT1(X)D** initiate the connection and **[Waiting]** flashes briefly. When the room is connected is establish, the menu list appears for example figure 16;



Figure 16 Successful connection

5. Turn **DIAL** and to select **BACK** to return to connected node display (Figure 12)

WIRES X – The Bible

Search & Direct on the FT1(X)D

You can search for a Node or Room by its name.

1. When the Main Screen is displayed, press and hold the **ENT** key for a second and the menu for the local node appear.

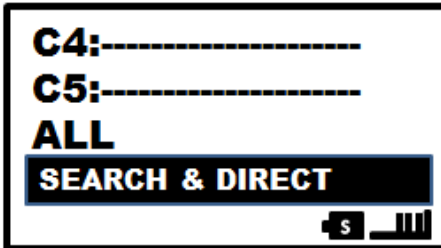

Figure 17 Select SEARCH & DIRECT

2. Press the **ENT** key and the character in screen appears.

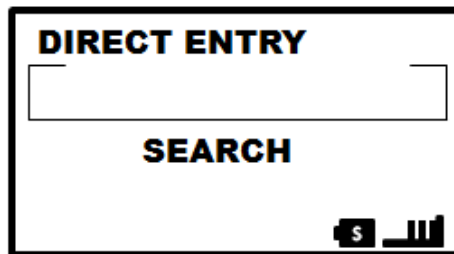

Figure 18 SEARCH Input screen

3. Use the Transceiver's keypad to enter all or part of the room name or node name to search for...

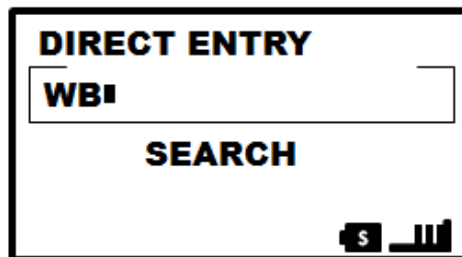

Figure 19 Characters entered from Keypad

Figure 19 shows a partial entry for a room name to search for.

Refer to the transceiver's manual for how to use the keypad to enter characters.

WIRES X – The Bible

4. Press and hold the **ENT** key for over a second; [SEARCH] will become selected. See Figure 20;

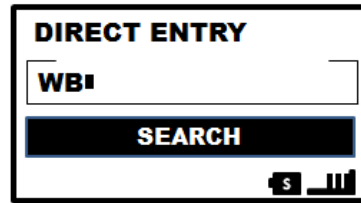

Figure 20 Select SEARCH

5. Press **ENT** to start the SEARCH.

The requested search starts and the [WAITING] flashes briefly. If the search is a partial entry the names of the rooms on nodes appears as a list. Turn the **DIAL** to select the desired room or node from the list.

6. Once the selection is made, press the **ENT** key. The FT1(X)D initiates connection and when the connect is successful , the Main Screen appears displaying the connect room or node (figure 12).

Connecting to previously connected Room or Node on the FT1(X)D

If you were previously connected to a node or room, it is displayed as flashing at the bottom of the screen as shown in figure 21.

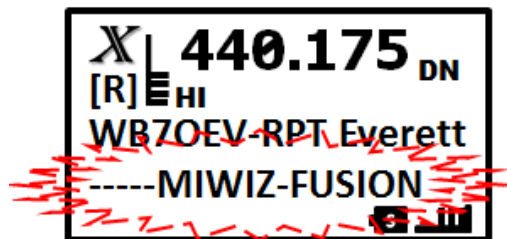

Figure 21 previously connect Room

When the room is flashing and this is the desired room...you can either press **ENT** or momentarily press the **PTT** to reconnect. When the connection is established the Room stops flashing.

WIRES X – The Bible

Using the DTMF ID to connect to a Room on the FT1(X)D

You can use the DTMF ID to directly connect to a room, use the following;

1. Press **F** and then press **V/M** and the DTMF input screen appears, figure 22.

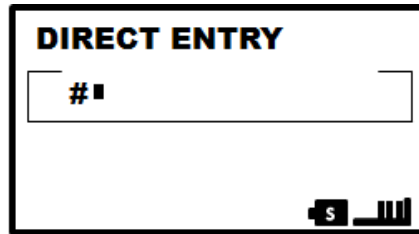

Figure 22 DTMF Input Screen

2. Enter the 5-digit DTMF ID. As shown in figure 23.

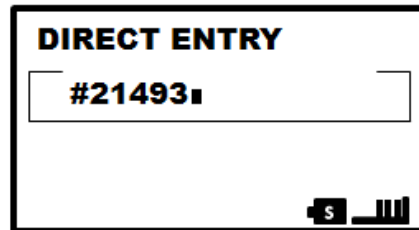

Figure 23 Enter DTMF ID

3. Press **ENT** for over a second to connect to Room.

Now **FT1(X)D** can communicate with other Nodes in the connected Room.

This is a very *brief* explanation on the use of the WIRES X digital mode for **FT1(X)D**.

For more information on using WIRES X for the **FT1(X)D**, please download and refer to [FT1DR/DE Instruction Manual \(WIRES-X Edition\)](#) from Yaesu's Web Site.

Note: WIRES X is only available on **VFO A**. When the **FT1(X)D** is set on **VFO B** as the operating VFO, pressing the **Dx** key for over a second or more, the transceiver switches to **VFO A** and automatically becomes the operational VFO.

WIRES X – The Bible

The FT2D

Connect to local node using the FT2D

1. Turn the **DIAL** to set **VFO A** to the frequency of the local node or touch **VFO A** display to bring up the numeric keypad (figure 24).

Note. The **FT2D** allows the entry of the frequency using the keypad via the touch screen. Just tap **VFO A** on touch screen.

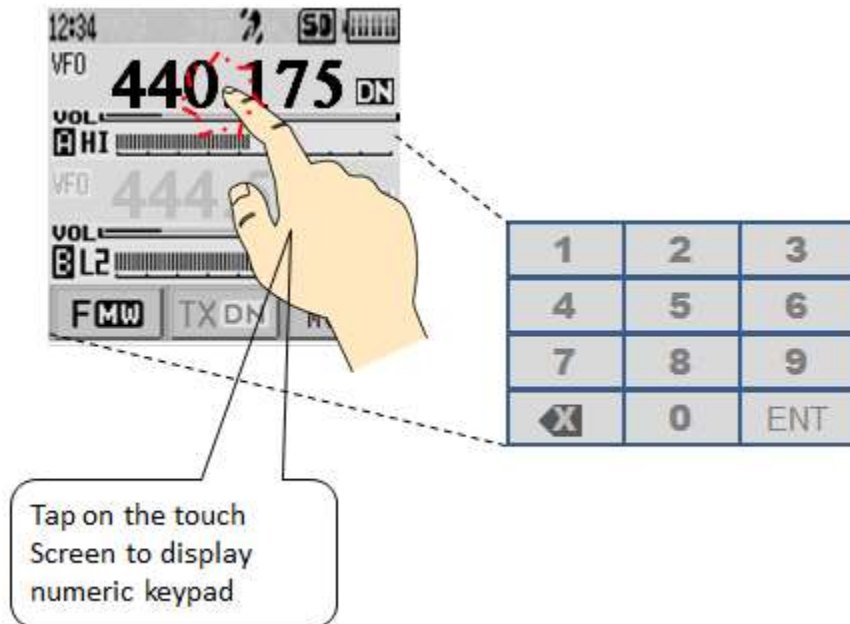



Figure 24 use the numeric keypad to enter the local node operating frequency

2. Press the  to start the WIRES X to start the connection to the local node.

 flashes on the left side of the frequency display until it finds a node;



Figure 25 connecting to a local node

WIRES X – The Bible

When the local node connects the **X** is solid, the node name and city appear on the bottom part of the screen (figure 26).

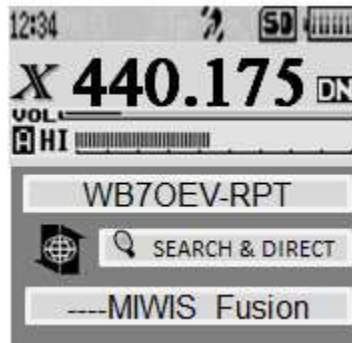



Figure 26 Connect to local node

Figure 26 shows the **FT2D** connected to the local node.

The **FT2D** has now connected to a local node. The procedure above is a brief description on the step required to connect. You can get more detail on the connection process from Yaesu's FT2DR Instruction Manual (WIRES X Edition) from www.yaesu.com.

Note: The FT2D support digital on **VFO A** and **VFO B**, WIRES X can be only on **VFO A**. If **VFO B** is active, pressing the  key automatically switches to **VFO A** and it becomes the active VFO.
During the connection phase and a node is not found, the **X** will disappear after 30 seconds.

WIRES X – The Bible

Supplemental Screen information of FT2DR

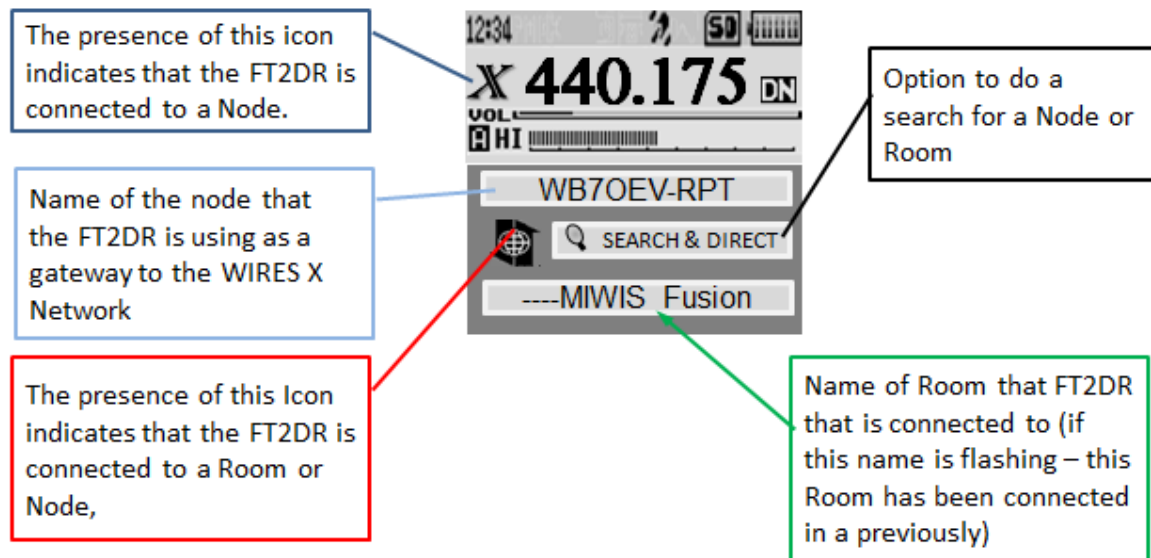

Figure 26a Screen Information

WIRES X – The Bible

Connecting to a node or room on the Internet using the FT2D

The following is a brief description on how you can connect to a specific node or room using the FT2DR. You can connect using one of the following ways.

- Selecting an active node or from a list
- Specifying a node or room name
- Selecting the most recently connected node or room
- Use the DTMF ID of the node or room

Searching for node or room from a list using the FT2D

1. On the FT1DR screen, touch the [SEARCH & DIRECT].

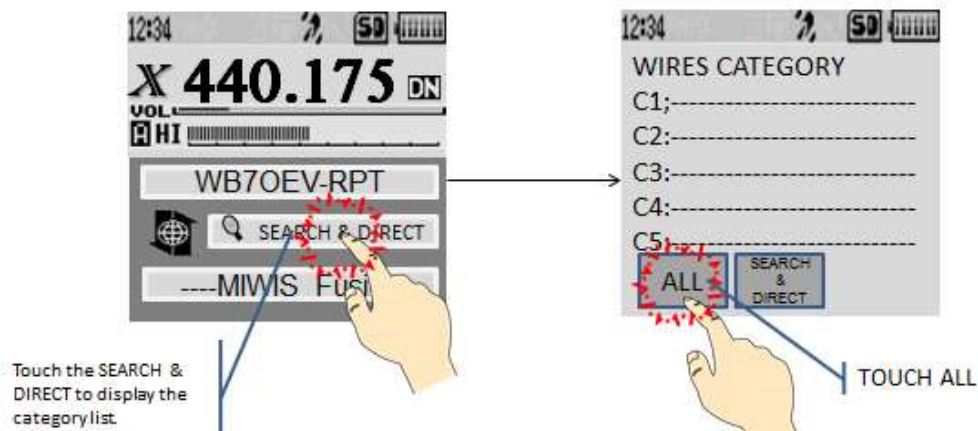

Figure 27 Search & Direct displays Category list

2. The [ALL] see figure 27, this displays the list of active nodes and rooms.
3. Touch the node or room to connect figure 28.

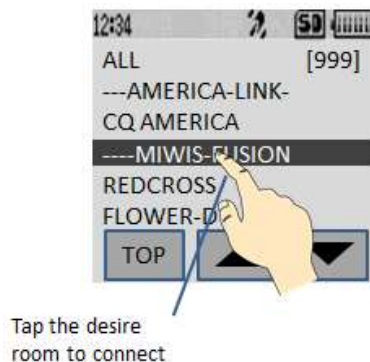

Figure 28 touch to connect

WIRES X – The Bible

Once the connection is made the menu list of the node (room) appears (figure 29).



Figure 29 Menu list of Room

Note: If the room fails to connect an error message is display briefly and display returns to the list of node and room.

This completes the process for searching the nodes and rooms list. For further information refer to *Yaesu's FT2DR Instruction Manual (WIRES X Edition)*.

WIRES X – The Bible

Searching by the node or room name using the FT2D

1. From the local node display touch **[SEARCH & DIRECT]**.

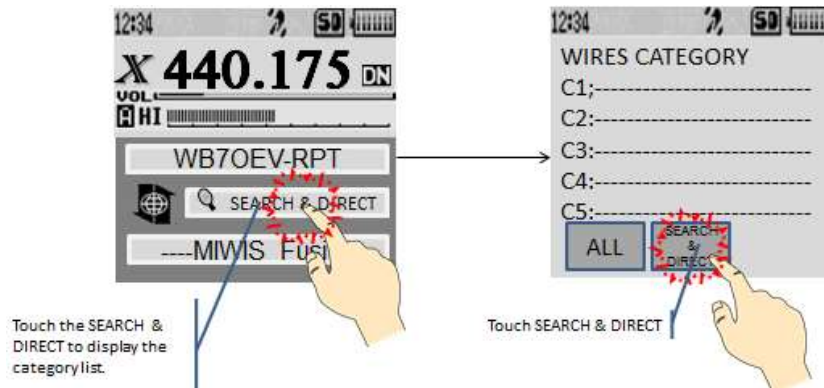

Figure 30 Searches by Name

2. Touch **[SEARCH & DIRECT]** on the WIRES CATEGORY screen (figure 30) and the alpha keypad is displayed. Enter the full or partial name of the room for the search and then touch **[ENT]**, shown in figure 31.

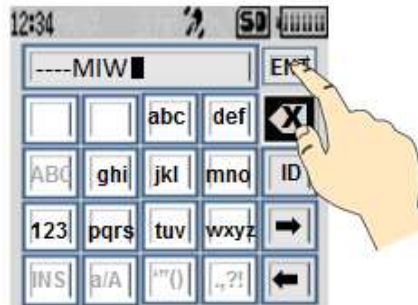

Figure 31 Entering search string, tap ENT

After tapping the **[ENT]** (figure 31), the searched list appear.

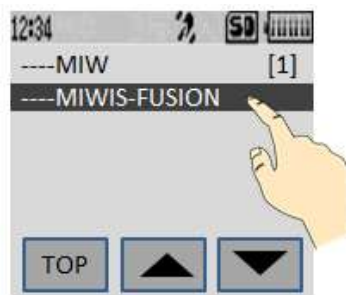

Figure 32 Tap the Room to connect

WIRES X – The Bible

Tap on the room to connect (figure 32). Once the connection is successful, the menu list of the node (room) you connected to appear.

This completes the process for search for nodes or rooms by name. You can find more information from *Yaesu's FT2DR Instruction Manual (WIRES X Edition)*.

WIRES X – The Bible

Connect to a node or room that you were most recently connected

The node or room that was recently connected too will appear on the bottom of the screen flashing see figure 33;

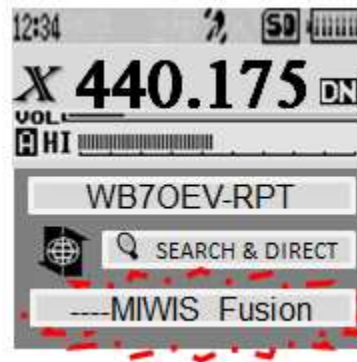

Figure 33 previously connected room

Touch the flashing room to connect and once connected the room stops flashing.

Note: If there is a ▶ of the left side of the room name...turn the **DIAL** to display the room that was most recently connected. If the connection is unsuccessful, an error message appears the room name flashed again.

Specifying the DTMF ID of the node or room to connect

1. While displaying the local touch [SEARCH & DIRECT]...

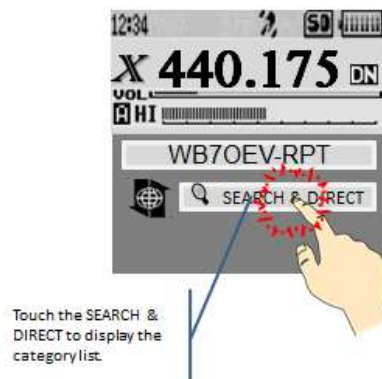

Figure 34 touch SEARCH & DIRECT to brings category list

This displays the category input screen.

WIRES X – The Bible

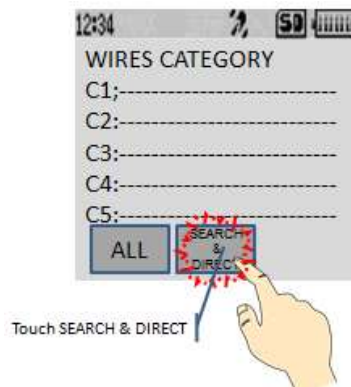

Figure 35 Tap SEARCH & DIRECT

2. Tap [SEARCH & DIRECT] (figure 35) and the character input screen is displayed;

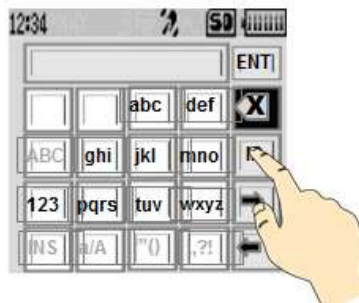

Figure 36 the character input screen

3. Now touch the [ID] (figure 36) and the following appears;

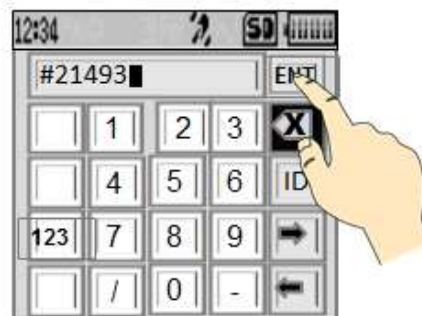

Figure 37 Entering the DTMF ID

4. Enter the DTMF ID and touch [ENT] (figure 37).

When the connection is successful, the node or room appears on the bottom of the screen shown in the following.

WIRES X – The Bible

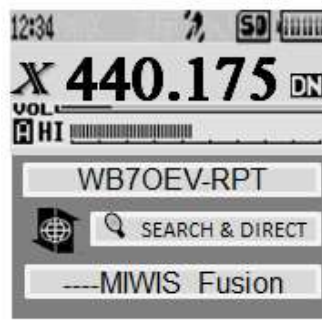

Figure 38 the connected Room

This completes the process for connecting to a room or node. Now you are ready to communicate with others. While the screen (figure 38) is displayed, show the connected room. You are ready for to contact anyone connected to the displayed room.

You can find more information in *Yaesu's FT2DR Instruction Manual (WIRES X Edition)*.

WIRES X – The Bible

Tip: Power Setting in WIRES X

There was a question that came up during a QSO and that was “How do you change the power setting while the FT2D is in the WIRES X mode, without having to leave WIRES X?”

The following illustrates how to change the power setting while in WIRES X;



There has been some question on how to change the transmit power of the FT2D while in the WIRES X mode. As you can see, you do not see the [F MW] button which is usually at the bottom of the screen, as shown below....



When in the WIRES X mode the screen appears as shown on the left...It would appear that one would have to leave the WIRES X mode to change the power and return to the WIRES X mode in the normal fashion.

There is a method to change the power setting on the FT2D while in the WIRES X mode.

Press the [V/M] button and the display changes to the dual VFO display and shown in the next page.

WIRES X – The Bible



3) Press the [TXPWR] to change the power. When completed, press [FMW] to Return to the previous screen.

2) Now with the [FMW] button available, you can now Press it to display the sub-menu (shown above) to change the power setting while still in the WIRES X mode.

1) Press the V/M key change the display as shown on the left. The FT2D is still the WIRES X mode and shown with X icon in the VFO A. You will also notice you now see the [FMW] button the screen.

WIRES X – The Bible

Connection WIRES X using an FTM 100DR

Connecting to a the local node

Before using WIRES X, press  to set the communication mode of the operation to DN mode.

Note: Press the  key several times to cycle to the DN mode (Digital Narrow).

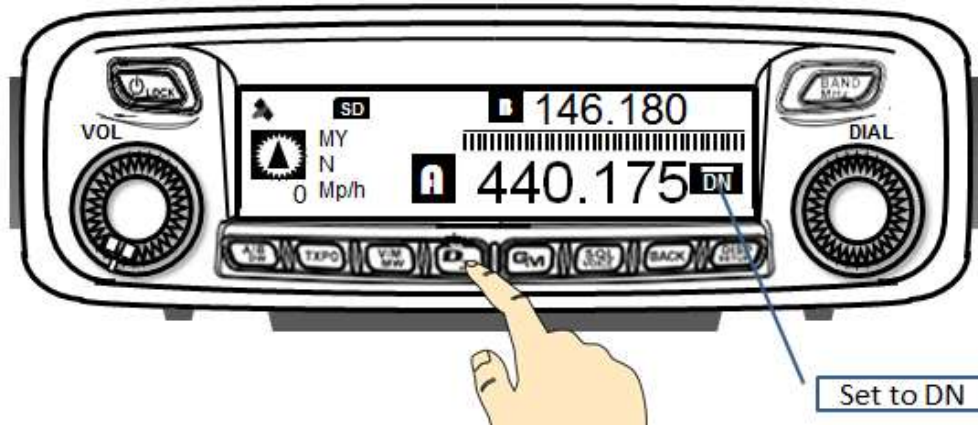



Figure 39 DN Mode on the FTM-100

Note 2: Pressing the  key cycles through the communication mode

FM → DN → VW → FM.

1. Turn the **DIAL** to set the operating frequency of the local node.

Note: set FTM 100 to **VFO A**.

2. Press and hold  key for over a second.



Figure 40 X flashes while searching for a node

When the local node is connected the [X] is not flashing and the node and city name appear on the display on the upper part of the screen, see figure 41.



Figure 41 local node is connected

WIRES X – The Bible

If this the first time the transceiver has been used on WIRES X, the node is connected but the room is unable to connect as shown in figure 41; there is no room displays above the frequency, the FTM 100 has not been on WIRES X. If the transceiver has been on Wires X, the display appears as shown in the following;

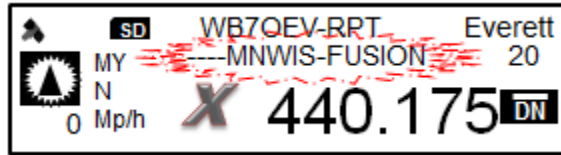

Figure 42 node and flashing room shown

The connected node is displayed and the flashing room is also displayed.

Turn the **DIAL** to select the room to connect to if there is a list of rooms...a ► is displayed showing which room selected, figure 43.



Figure 43 Node connected with an indication showing the connected room

These processes are described in detail in the *FTM 100DR Instruction Manual (WIRES X Edition)*, available at www.yaesu.com.

WIRES X – The Bible

Connecting to a node or room on the Internet using a FTM 100DR

There are several ways to connect to a node or room, the following briefly describe several ways to connect. This is one of those ways;

Searching from the node and room lists



1. Press the  key over a second to display the category list.



Figure 44 Press BAND button to display category list

2. Turn **DIAL** to select node or room then press  to connect to.

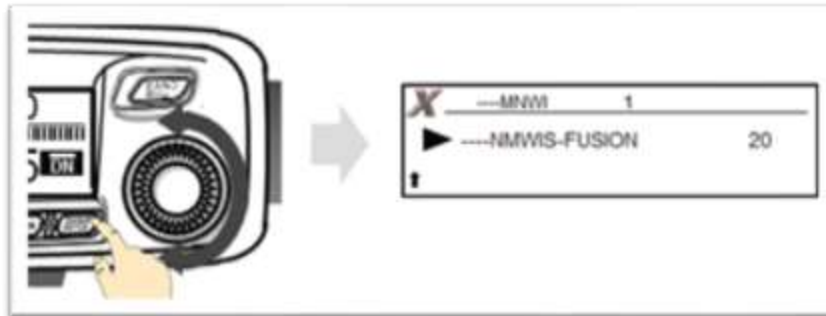

Figure 45 Node or Room selections

When the connection from figure 45 is made, then a menu list of rooms is displayed as shown in figure 46.

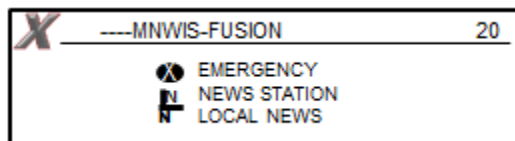



Figure 46 the connected room from the menu list

Press  to display the main screen.

WIRES X – The Bible

Searching by node or room name

1. Press  button for over a second to display the category list;

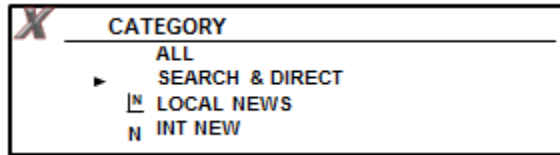

Figure 47 Category list



2. Turn  to select [SEARCH & DIRECT] and press  the character and the input screen appears;



Figure 48 Character input screen

Note: See *FTM 100DR Instruction Manual (WIRES X Edition)* for “Inputting Characters” on page 7.

3. Enter all or part of the user ID or room name, the character you have entered appears on the screen as shown in figure 48.
4. Press , to display room list.

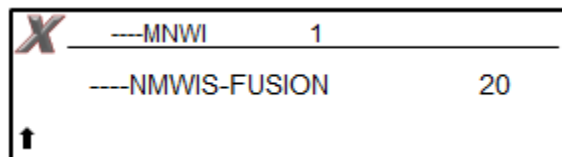



Figure 49 the List of the Rooms found

5. Turn  to select the node or node you want to connect to;

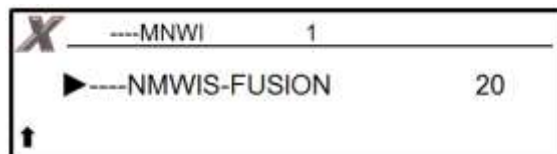

Figure 50 selecting the room

Then press the  to connect to the room, (figure 50).

WIRES X – The Bible

Once you are connected the room that you searched for from the menu list of the rooms is displayed, (figure 51).



Figure 51 the screen showing the connected room

Connecting to the room you have most recently connected

If you previously connected to a room and put the FTM 100DR into the WIRES X digital mode; the room appears and flashes on the upper part of the screen.

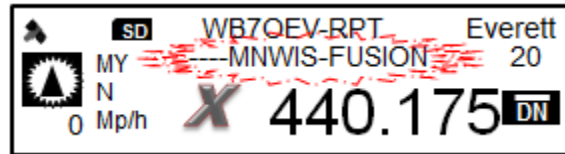



Figure 52 display shows a previously connected room flashing

Press  to connect to the flashing room. **Note:** Momentarily press the PTT will connect to the room also.



IF there is  on the left side of the room on the upper part of the screen indicate a presences of list of previously connected rooms. Turn the  to display the room you have most recently connected to.



Figure 53 indication of a list of recent rooms

WIRES X – The Bible

Specify the DTMF ID of the node or room you want to connect to

1. Press and hold [#] on the microphone for a second or more, displays the **DTMF** input screen.
2. Use the numeric keys on the microphone to enter the **DTMF ID** (five-digit code).
3. Press [#] on the microphone to connect.

Note: Press [*] on the microphone to close the DTMF input screen.

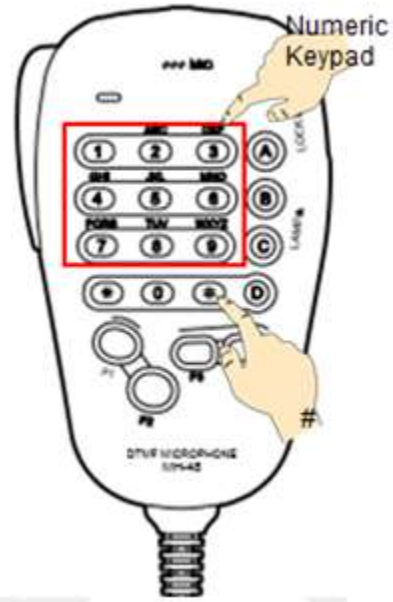



Figure 54 mic input

Note: You can communicate with the node or room you are connected to by pressing [PTT].

This completes this brief description for the uses on WIRES X with the FTM 100DR. For further details on the use of WIRES X please refer to *Yaesu's FTM 100DR instruction Manual (WIRES X Edition)*, available on www.yaesu.com.

WIRES X – The Bible

Connection WIRES X using an FTM 400DR

Note: before using WIRES X on the FTM 400DR, press the  momentarily to cycle the communication mode of on VFO A (figure 55) to DN. This is the recommend mode to operating in while on WIRES X. For further details refer to Yaesu's FTM 400DR Instruction Manual.

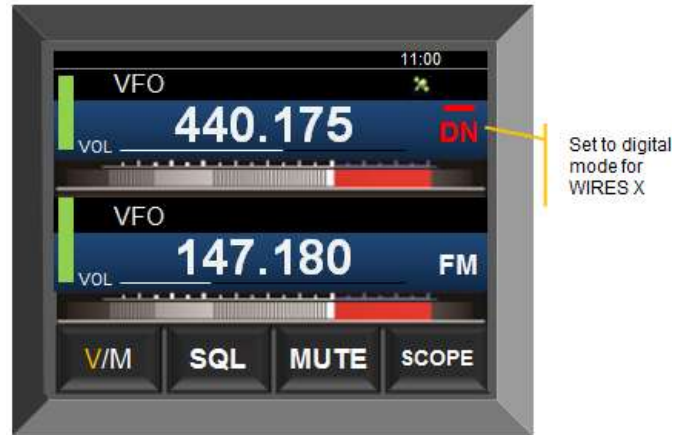



Figure 55 Set to DN

Connecting the FTM 400DR in Digital Mode

1. Turn  to the frequency of the local node that you want to connect to on **VFO A**.

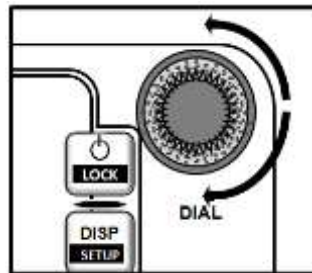



Figure 56 Using the DIAL to adjust the Frequency

Note: You can also enter the frequency by pressing  and touch  in the function menu displayed to set the frequency by the numeric keypad.

WIRES X – The Bible

2. Press the  key for over a second, the **WIRES X** icon appear on the left side of the frequency and starts flashing to try to connect to the local node.



Figure 57 Connect to the local node

When the local node is connected the “X” is not flashing and the node and city name appears on the bottom part of the screen.



Figure 58 node connected successful

Note: There can be several different indication that show how the node is connected, they are:

- When the “X” is flashing press the  key to re-establish the connection to the local node.
- If the local node cannot be found, the “X” will disappear in 20 second. Basically letting you know there not a local to be found or if there is a node, it's not connecting.

WIRES X – The Bible

- If the local node that you connected to, is a repeater, an “**R**” appears on the top part of the WIRES X icon, see figure 59.



Figure 59 connected to a repeater

Note: WIRES X can only use on **VFO A**. If you are on **VFO B** as the operational **VFO**, press and hold  for over a second and the transceiver to change from **VFO B** to **VFO A** automatically to operate in the WIRES X digital mode.

WIRES X – The Bible

Connecting to a node or room on the Internet using the FTM 400DR

You can connect to a node or room in several ways:

- Select an active node or room from the list.
- Specify the node or room name.
- Connect to the most recently connected node or room. A previously connected node or room.

Searching from the node or room list

1. Touch the ▼ on the connection destination screen and the menu list of the local node appears.



Figure 60 initiating a search to get the list

2. Turn the  or touch the screen to select [ALL] ;

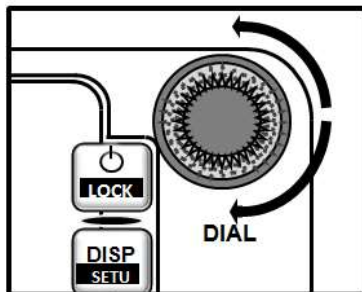

Turn the DIAL



Tap ALL

Figure 61 Dial or touch ALL

WIRES X – The Bible

3. Touching **[ALL]** brings up a list of active nodes and rooms.



Figure 62 list of active nodes and rooms

4. Turn the **DIAL** or touch the screen to select the desired node or room to connect to.

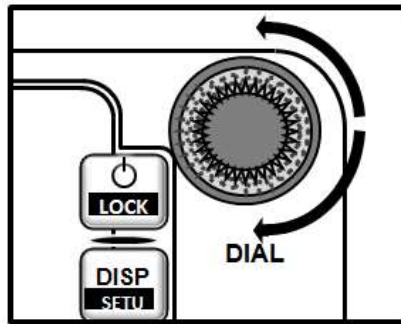

Turn the DIAL or



Tap on desired Room to connect

Figure 63 select the node or room from list

The connection starts and the node or room name flashes briefly, when the connection is successfully established the name of the node or room appears.

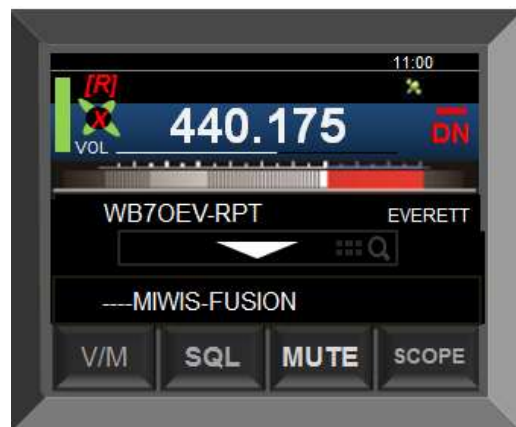

Figure 64 room connected successfully

WIRES X – The Bible

Searching by node or room name using the FTM 400DR

1. Touch ▼ on the connection destination screen, the category list on the transceiver appears.



Figure 65 getting the category list

2. Tap on [SEARCH & DIRECT] and the character input screen show up.

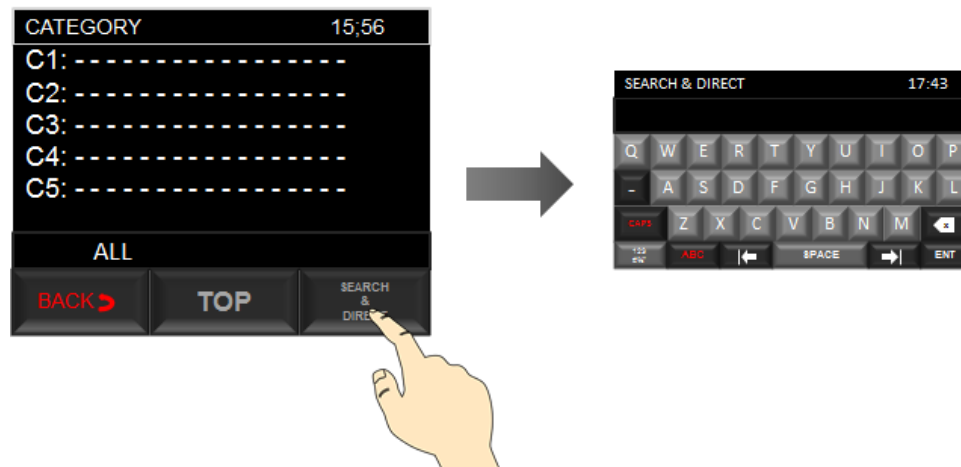

Figure 66 tap on the SEARCH & DIRECT to display the character input screen

WIRES X – The Bible

3. Touch the character keys to enter a partial or the entire node or room name for find, e.g. figure 67.



Figure 67 input screen

4. After entering the node or room name, touch [ENT] to start the connection. If the connection name is a partial matching name is found, they will be listed.



Figure 68 touch ENT to start search

Note: if there's in no nodes or a room matching what has been entered, "No Matches" appears on the screen and input screen remains.

- If name of the node or room that's been entered is found. The transceiver initiates the connection to the node or room.
- The screen displays all results for a partial node or room name as a list.
- On the room columns in the search results the number of node in a rooms are shown on the right of the room name.

WIRES X – The Bible

5. Turn  or touch the screen to select the node or room to connect to.

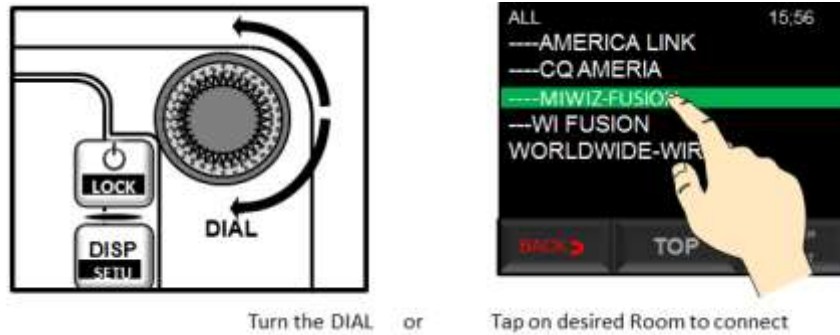

Figure 69 start connection

6. Touch the selected room to connect to.

The connection starts and the room name flashes briefly. When the connection is made, the name of the room is displayed shown in figure 64.

Connecting to the node of room you have most recently connected using FTM 400DR

If the node or room is one that you have connected to in the past, the name of the last connected room is displayed in grey at the bottom of the screen. You can touch the room name or press the [PTT] to initiate to restart the connection. Upon successful connection the room name turns to white.

Specifying the DTMF ID of the desired node or room

1. Press and hold the “#” on the microphone. The DTMF input screen appears
2. Enter the DTMF ID e.g. 21493.
3. Momentary press the “#” on the microphone. The connection initiated.

This is not the complete process for using the WIRES X digital mode, there are more details in Yaesu’s FTM 400DR Instruction Manual (WIRES X Edition), available from www.yaesu.com.

WIRES X – The Bible

The FT-991

Connecting to a Local Node in Digital Mode on the FT-991

On the FT-991, in order to use WIRES X, set the communication (modulation mode) to C4FM. Use the following process to set the FT-991 to digital.

1. Set the communication mode to C4FM.

After pressing the **MODE** button, touch “C4FM”, then press the **MODE** Button again.



Figure 70 press MODE button, touch “C4FM”, then the MODE Button again

2. Tune to the frequency of the local node to connect to.
3. Press the  button.
4. Touch [**X**].



Figure 71 The FT-991 automatically switches to transmit mode and “X” and WIRES X icon flashes.

WIRES X – The Bible

When the local node is found “X” stopped flashing and the node name and city appears, figure 72.



Figure 72 FT-991 connected to node

There are a several items to note:

- While “X” is flashing, you can briefly press the [X] to reconnect to the local node that was previously connected.
- Again while the “X” is flashing, press and hold [X] for a second or better to cancel the connect operation.
- When a local node cannot be found, the **WIRES X** icon will disappear in 20 seconds
- When the local node is found and is on a repeater, **WIRES X** icons appears with a [R] on it right.

Depending on the connection status, the screen with show one of four displays.

1. Connect to a local node, but not able to connect to the nodes or rooms (no previously connected rooms or node).



Figure 73 no nodes or rooms connected

WIRES X – The Bible

2. Connected to local node, but unable to connect to internet node or room (previously connected internet node or room).



Figure 74 previously connected room

3. Connected to the local node, successfully connected to an Internet node or room (the Internet node or room is the same as the one previously used).



Figure 75 Room connected successfully

4. Connected to the local node, successfully connected to an Internet node or room (the Internet node or room is different from the one previously used).



Figure 76 previously connected room

WIRES X – The Bible

Connecting to a node or room on the internet using FT-991

Searching from the node or room list

1. When the FT-991 is connected to a local not, touch **[ALL]** to start the search. **“Waiting”** momentarily flashes on the display and a list of active nodes and room are displayed.



Figure 77 touching [ALL] displays the rooms and nodes list

Note:

- The rooms are displayed first and then the nodes are listed.
 - On the display, rooms are displayed with the number on nodes that are connected. Nodes are displayed without a numbers. That how to tell the difference between nodes and rooms displayed in the list.
2. Turn the **“MULTI”** knob or touch the screen to select room or node to connect to.

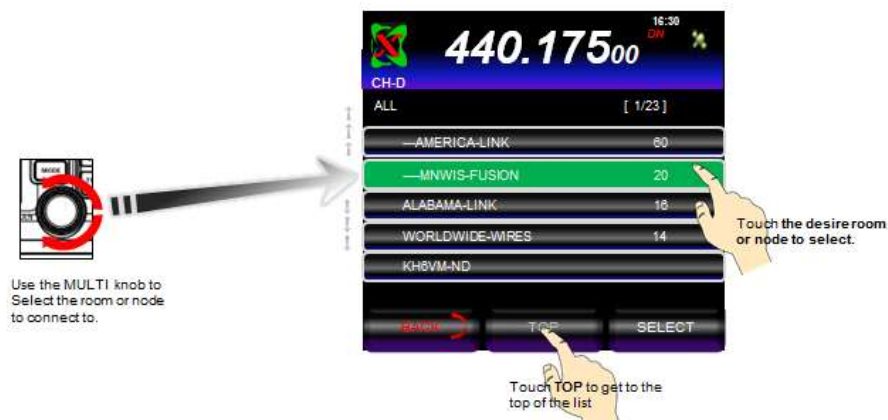

Figure 78 navigation of rooms and nodes list

Note: Touch **[TOP]** jumps to the top of the list.

WIRES X – The Bible

Search by Node or Room Name using the FT-991

1. When the FT-991 is connected to a local node, touch [SEARCH & DIRECT], the alphabetic keyboard is displayed.



Figure 79 touch here to display alpha keyboard

2. On the alpha keyboard enter all or part of the room ID to search for, e.g. “---MNW”, then touch [ENT].

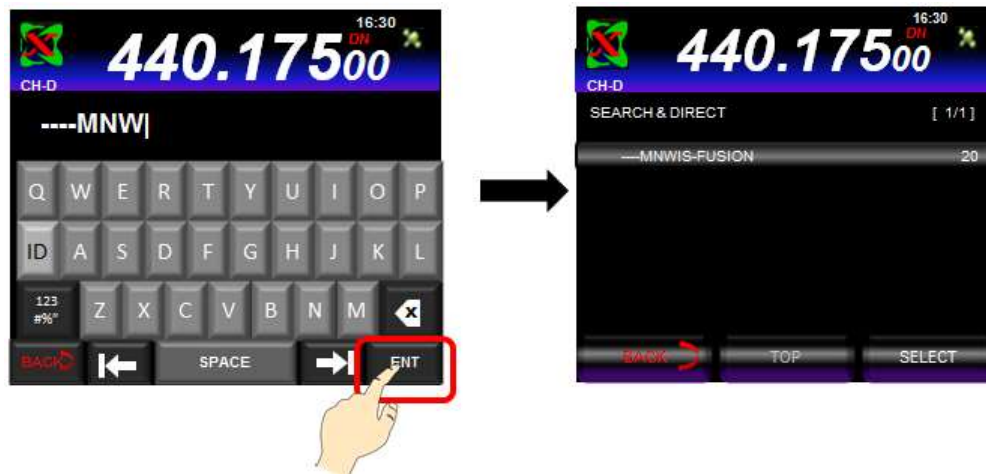

Figure 80 results of the search is a single room

Note:

- If there are no rooms or node matching the entered name, “No Data” briefly appears and the screen returns to the [SEARCH & DIRECT] screen ready for another search.
- Now if the name entered is found, the FT-991 connects to the room immediately.

WIRES X – The Bible

- The screen displays the room list search results followed by the node also found.
 - The room displayed on the list also shows the number of nodes that are currently connected to room.
3. Turn the **MULTI** knob or tap the screen to select the room that you want to connect to then touch **[SELECT]**.



Figure 81 selecting the room and connecting

Once the connection is successful, “Connected” is briefly displayed on the screen and then changes to show the information of the room.



Figure 82 Connected room e.g. MNWIS-FUSION

WIRES X – The Bible

Reconnecting to the most recently connected Room or Node

In a Room or Node was previously connected to, it appears and flashes at the bottom of the screen when the FT-991 is set back into the WIRES X mode.

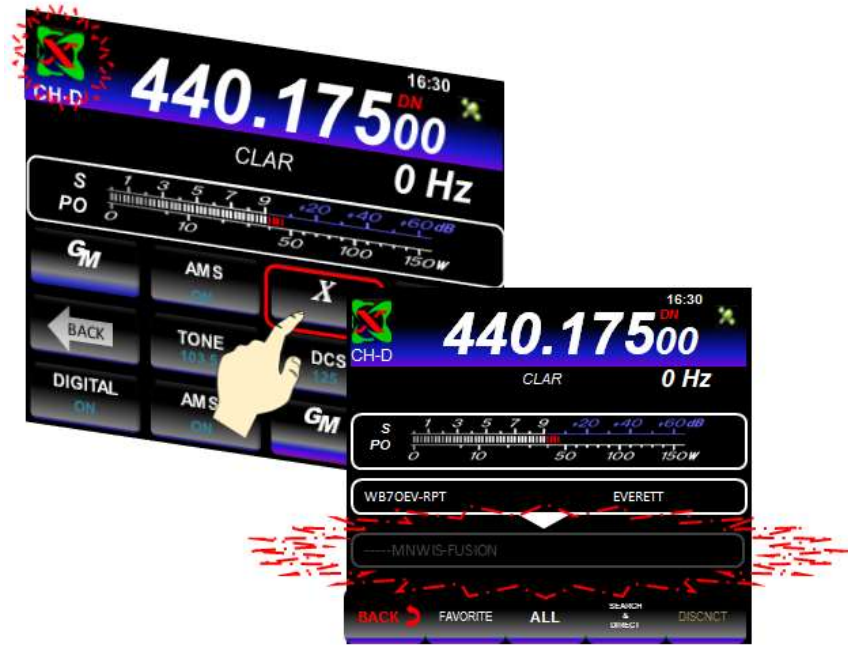

Figure 83 switch to WIRES X showing previously connect room

Touch the flashing room to reconnect, once it is connected it, the Room ID and information appears, see figure 84.

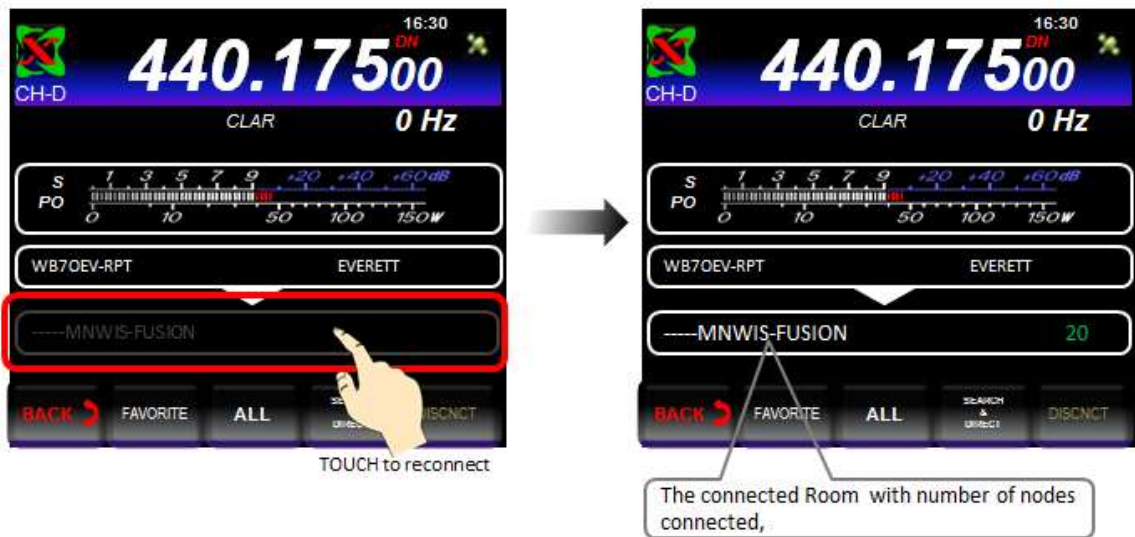

Figure 84 connecting to a previous room or node

WIRES X – The Bible

Specifying the DTMF ID of the Room or Node to Connect to

1. When the FT-991 is connected to a local node touch [SEARCH & DIRECT], the numeric keypad is displayed.



Figure 85 Touch SEARCH & DIRECT to present the numeric keypad

Note: If the alpha keypad appears instead, touch the [ID] to switch to the numeric keypad.



Figure 86 An alternate method to display numeric keypad

WIRES X – The Bible

2. Enter the DTMF ID (Room or Node number) via the numeric keypad and then touch [ENT].



Figure 87 after entering the ID press ENT

The local node connects with the DTMF ID entered. Once the connection is made, “**Connected**” is briefly displayed followed by the ID of the Room that’s connect to.

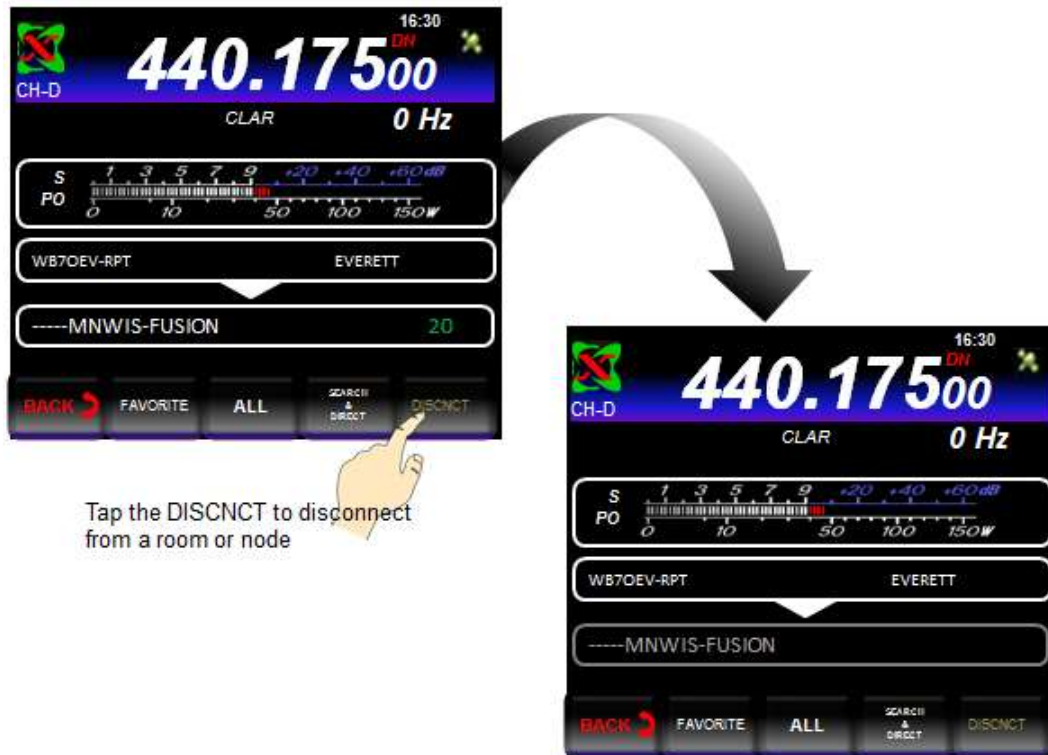

Figure 88 the connected room

WIRES X – The Bible

Disconnecting from a node or room on the FT-991

To disconnect from a room or node, touch [DISCNCT]. If the disconnect is successful, “Not Connected” briefly appears on the display and the screen return to the node connection screen.



Tap the DISCNCT to disconnect from a room or node

Figure 89 room or node disconnected

This concludes the process for using the FT-991 in the WIRES X digital mode. This section for the FT-991 does not cover all the option for utilizing WIRES X; refer to Yaesu’s FT-991 Instruction Manual (WIRES X Edition) for more information.

Summary

The preceding processes for the FT1D, FT1XD, FT2D, FTM 400D, FTM 3200D and FT-991 are by no means complete. These processes are intended to give you a brief description on how to get started with WIRES X. Yaesu has produced WIRES X manual for each model of the Fusion Radios with more information specific to each radio. You can find the manual for each Fusion Radio at www.yaesu.com.

WIRES X – The Bible

Room Disconnect for the various Yaesu C4FM Radios

The FT-991 has an easy method to disconnect from a room or node with in the WIRES X digital mode; touch the [DISCNCT] button. The FT1D, FT1XD, FT2D and FTM-400DR have a different mode for disconnecting from a room or node, while in WIRES X mode. The following is a brief description on disconnecting by radio model.

FT1D and FT1XD Disconnect

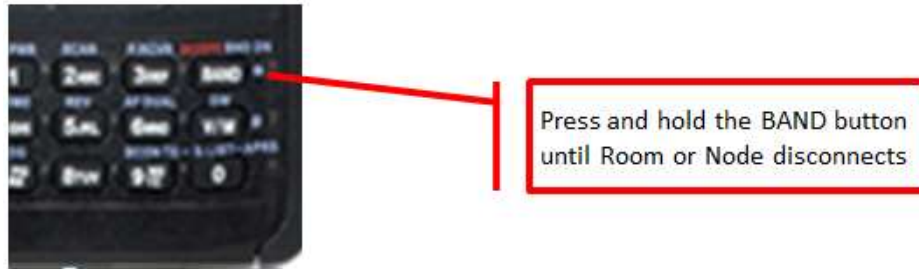

Figure 90 FT1D and FT1XD Disconnect method

FT2D Disconnect



Figure 91 FT2D Disconnect methods

FTM-400DR Disconnect

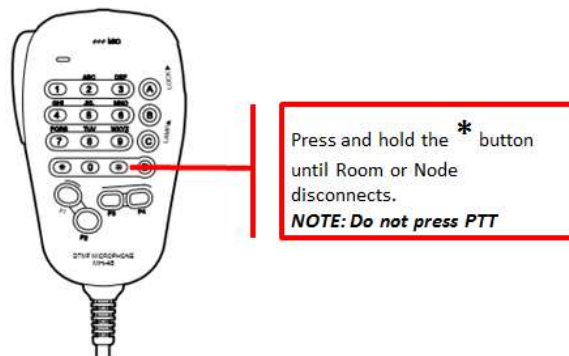

Figure 92 FTM-400DR Disconnect method

WIRES X – The Bible

NOTE: In order to disconnect from a room or node while in WIRES X digital mode...the room or node must be inactive, i.e. no transmission must be going on.

Summary

The preceding processes for the **FT1D, FT1XD, FT2D, FTM 400D, FTM 3200D** and **FT-991** are by no means complete. These processes are intended to give you a brief description on how to get started with WIRES X. Yaesu has produced WIRES X manuals for each model of the Fusion Radios with more information specific to each radio. You can find the manuals for each Fusion Radio at www.yaesu.com.

WIRES X – The Bible

How to set up a WIRES X Node (WB7OEV Style)

In the section, we will cover how to set up a WIRES X node. This is this author's interpretation on how to step a node, others may have better techniques for setting one up.

Let's ask the question...what is a node? Well, as described in the section's "[Local Node](#)" of this document, "The Local Node is a personal Amateur Radio Station (usually a base station) operating on a VHF/UHF simplex frequency, linked to a PC that's connected the internet".

Okay, let's get started. First we need to gather up some items that make up a node. We need the following;

- A radio that support C4FM preferably a Yaesu FTM 100

Let start with the radio, first of all one must be a licensed Amateur Radio Operator, because the radio require, operates on the Amateur Radio band of 2 meters or 70 centimeters. The radio must support the C4FM digital mode developed by Yaesu for the Amateur Radio Community. This radio interfaces to Yaesu's HRI-200. The radio of choice for our setup will be the FTM 100D. It is assumed along with the FTM 100 you also have the appropriate antenna setup along with all the other gear required to operate an Amateur Radio Station.

- An Yaesu HRI-200 WIRES X interface

The Yaesu WIRES-X HRI-200 enables Internet to RF communications that expands the range of amateur radio using internet enabled Voice-over-IP technology. The amateur node station connects to the Internet and Interfaces to the WIRES-X Network. HRI-200 unit allows an Amateur Radio Base Station to communicate using VoIP over long distances reliably with ease to other WIRES X node. The HRI-200 is part of our connection to the Internet.

- PC that runs Microsoft's Windows 7 or Windows 10

This is a dedicated computer that links the HRI 200 and the Amateur Radio to the Internet. This computer runs the WIRES X PC software that communicates with the Internet. The PC used in this configuration is the PIPO X8 Tablet Computer. The configuration is;

- OS: Windows 10 with Bing + Android 4.4 KitKat Dual Boot System
- CPU: Intel Z3736F Quad Core
- 2GB DDR3L RAM + 32GB eMMC Bluetooth/WiFi/HDMI
- 7 inch 1280 x 800 pixels touch screen Package:1 x PIPO X8,1 x DC Charger
- PIPO X8 is a tablet pc, Windows 10 OS and Android OS.

WIRES X – The Bible

This is an inexpensive computer that's able to run the WIREX software.

- Yaesu WIRES X PC Software (currently version 1.120).
- Access to the Internet

The following are the requirements for the Internet connections.

- ADSL 8 Mbps or faster (high-speed connection recommended)
- Global IP address (dynamic or static address)
 - A unique IP address is necessary for each WIRES X node
 - All of the following 6 UDP (user datagram protocol) port must be open (connectable)
 - Port 46100, 46110, 46112, 46114, 46120 and 46122
A Router capable of port forwarding i.e. Actiontec FIOS MI424WR
When using a router a network address and port translation (NAPT) is necessary
 - One of the TCP ports must be connectable, for using the remote control function
 - Port 46190

These are the basic components that make up the WIRES X node.

First of all, I will start with the PC...in my case I chose the PIPO X8 Tablet PC. The reason for this, it is an inexpensive PC that can be dedicated to WIRES X with enough resources for support. The PIPO PC also comes with Windows 10 Home Edition.

What I mean by dedicated, the only program that's on it is Yaesu's WIRES X PC Software, no game, no word. The PIPO only purpose is to run WIRES X. If you need to run something else on this computer...don't.

PC Preparation

Now let's prepare the PC for WIRES X support.

1. If you have done so...update the pc with the latest Windows 10 software and patches.
2. Uninstall all unnecessary programs from the PC (Bloatware).

Note: use the **Apps and Features** to un-install programs such as;

Skype

Microsoft Office Offers

Any program that not necessary to support the PC.

WIRES X – The Bible

3. Optimize the PC by doing the following;

Limit the number of programs to run at start up.

To check programs that run a startup do the following;

a)  key + R opens the following windows dialog;

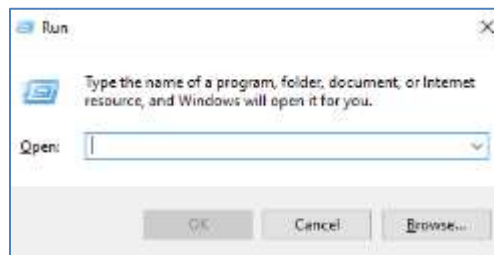

Figure 93 command dialog

b) Type “**taskmgr**” in the Open dialog box.

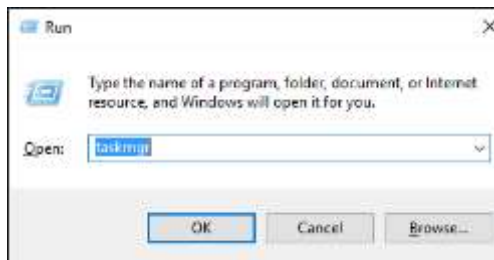

Figure 94 Enter "taskmgr" to start the Task Manager

c) Click on “**OK**” and the task manager dialog is displayed.

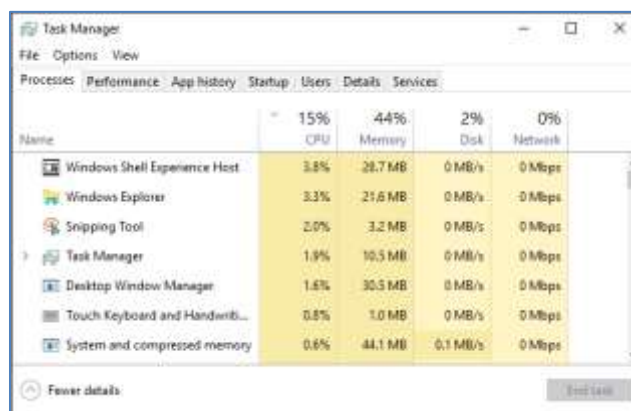

Figure 95 the Task Manager

WIRES X – The Bible

Click on the **Startup Tab** ... the following startup programs list is displayed.

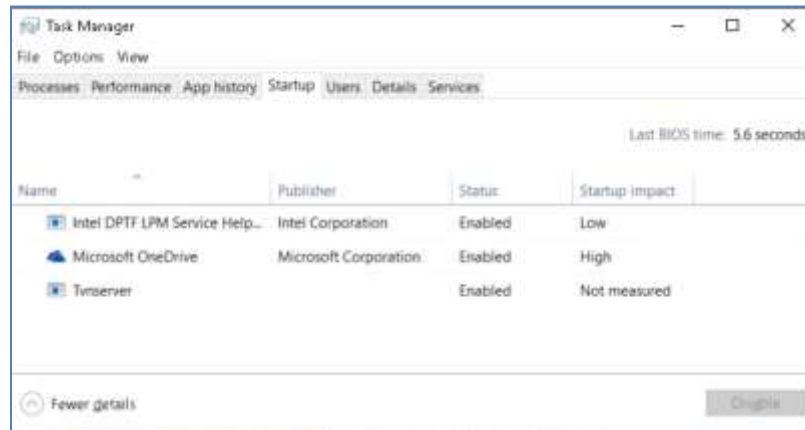

Figure 96 The "Startup" Tab

- d) Check to see which programs can be disabled at startup, for example **“Microsoft OneDrive”**. This program is not necessary for support this PC; we are not going ever use OneDrive to store data. Highlight **Microsoft OneDrive** and click **Disable**. The next time Windows restarts, Microsoft OneDrive support will not startup, thus not utilizing any resources.

Turn off Cortana

Open Cortana; click the Notebook icon in its left-hand options pane, then select Settings from the list. A bunch of options will appear. You'll want to slide “Cortana can give you suggestions, ideas, reminders, alerts and more” to **off**, which disables the assistant on the PC and removes all locally stored data she knows about you. Also turn off “Device search history” and turn **off** “Search online and include web results”.

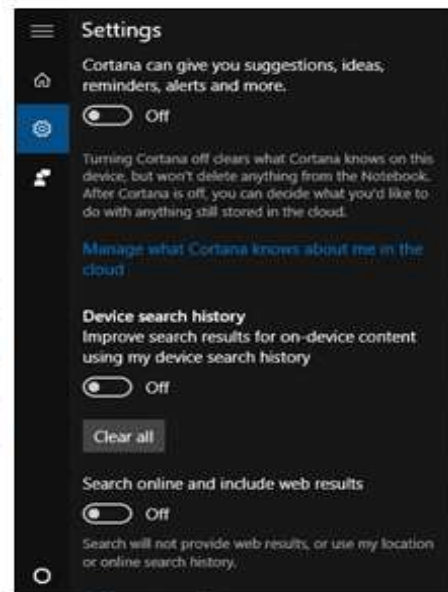



Figure 97 Cortana Settings

WIRES X – The Bible

Turn off visual effects

- a. Press  Key + X combination to see the following menu. Select “System”.

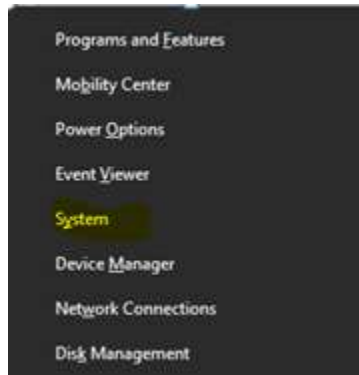

Figure 98 Select "System"

- b. In the System window, in the left pane, click on “Advanced system settings”.

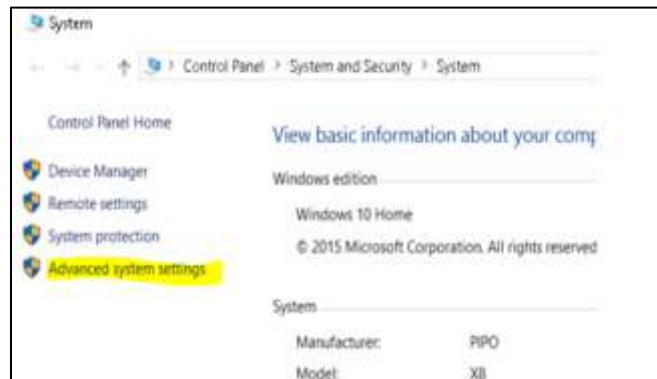

Figure 99 select Advanced settings

- c. In the System Properties window, pick “Settings” for Performance

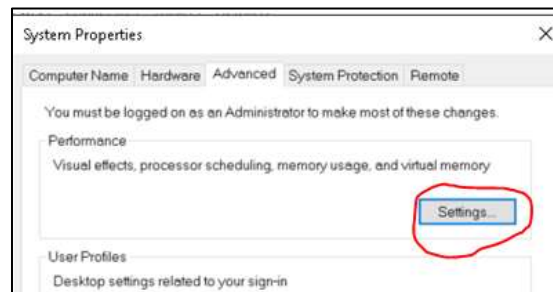

Figure 100 click on Settings

WIRES X – The Bible

- d. In the Performance Options window, you will see 3 options:
 - i. Let Windows choose what's best for my computer
 - ii. Adjust for best appearance
 - iii. Adjust for best performance.

In this case click “**Custom**” and turn everything off, uncheck all. Click [OK] to close all dialog boxes.



Figure 101 The Performance option dialog

Turning all visual effect off on the WIRES X PC frees up resource which allow for it to be remotely administered without affecting the WIRES X software. When remotely administered, the PC does not have sent all the visual effect back to the remote computer.

WIRES X – The Bible

Disable the PIPO WIFI Adapter and Enabling the Ethernet Adapter

The PIPO X8 Tablet PC has a WIFI Adapter that is used as the primary interface to the Internet. WIFI will work for WIRES X, but use it with care. WIFI is susceptible to interference from Microwave Oven, Cordless Phones, etc. *So at times whenever the WIRES X fails and you are using WIFI to connect to the Internet, check to see if someone is using the phone.* If you are going to use WIFI, skip this section. In this particular configuration of WIRES X, we are disabling the WIFI Adapter and enabling the on-board Ethernet adapter.

The following shows how to disable the WIFI the on-board adapter and enable the Ethernet adapter.

1.  key + R opens the following windows dialog;

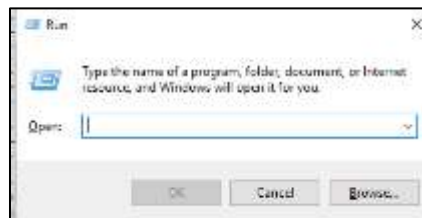

Figure 102 Command Dialog

2. Type **control panel** in the Open dialog then click “OK”.



Figure 103 The Control Dialog

WIRES X – The Bible

3. Click on **“Network and Internet”** and ...

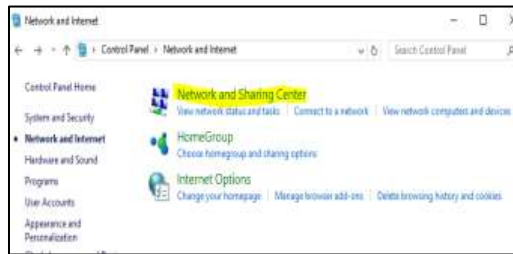

Figure 104 Select Network and Internet

4. Click on **“Network and Sharing Center”** and this display...”



Figure 105 Select Change adapter settings

5. Click on **“Change adapter settings”** and ...



Figure 106 Adapter Options for WiFi

WIRES X – The Bible

Right-click on the Wi-Fi adapter and a dialog display and click on “disable”. The dialog disappears, then highlight “Ethernet 2”, right-click and a dialog appears and click “enable”.

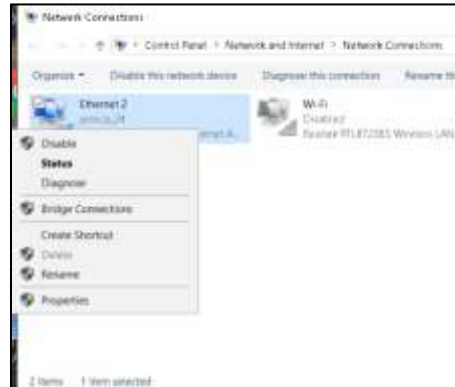



Figure 107 Adapter Option of Ethernet 2

6. Close all windows, the PIPO X8 Tablet PC is ready to be connected the Internet using a standard Ethernet cable.

Assign a Static IP to the WIRES X PC

The next item to do for the WIRES X PC is assign a static IP. By default the PC is set to DHCP in which the network router assigned an IP address to the PC. A new address may be assigned to the PC it starts up. If a new IP address is assigned automatically to the node PC, the address may be different from the one specified on the router. This action disables communication with the WIRES X Server. Because the ports that required by the WIRES X software are assigned to a specific IP on the router. That is the reason for assigning a specific IP on the PC. The following show how to assign a static IP on the PC. The following is the process for setting a static IP on the WIRES X PC.

Setting an IP Address on the PC

1.  key + R opens the following windows dialog;

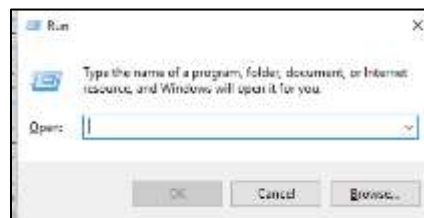

Figure 108 Command Dialog

WIRES X – The Bible

2. Type **control panel** in the Open dialog then click “OK”.



Figure 109 Control Panel Window

3. Click on “**Network and Internet**” and ...

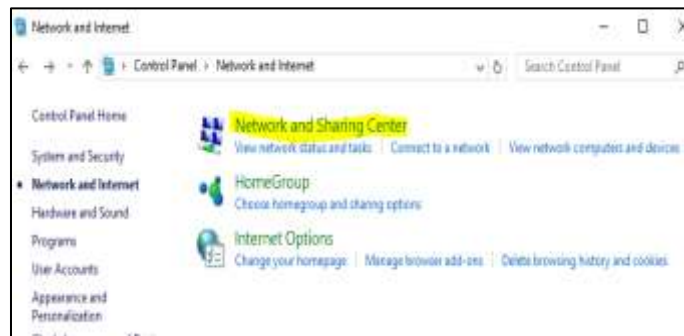

Figure 110 Select Network and Internet

4. Click on “**Network and Sharing Center**” and this display...



Figure 111 Select Change adapter settings

WIRES X – The Bible

5. Click on “**Change adapter settings**” and

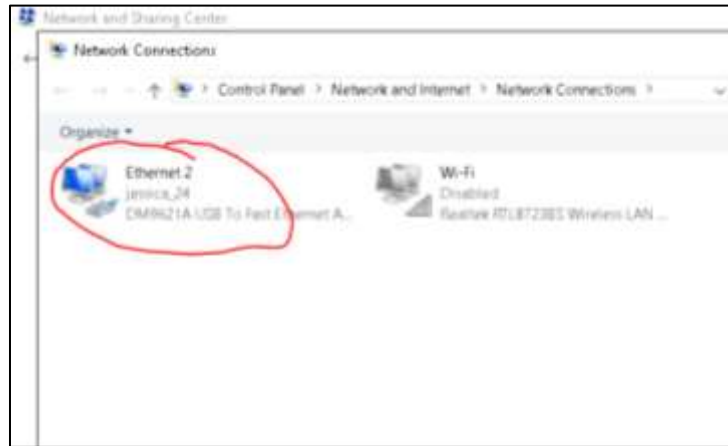

Figure 112 Highlight Ethernet 2

6. Double-click on “**Ethernet 2**” to get the status panel.



Figure 113 Ethernet 2 status

7. Click to the “**details**” button and the Network Connection Details panel appears

WIRES X – The Bible



Figure 114 Network Connection Details

8. Write down the “**IPv4 Address**”, “**IPv4 Subnet Mask**” and the “**IPv4 Default Gateway**” address and click on “**Close**” and the “**Ethernet 2 Status**” panel reappears.
9. Click on “**Properties**”.
10. The networking panel appears....

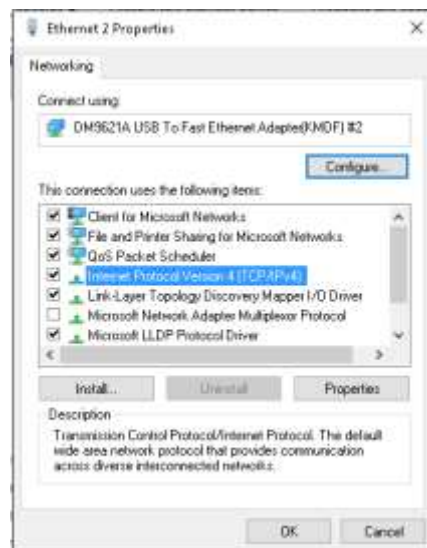

Figure 115 Highlight IPv4

11. Highlight “**Internet Protocol Version 4 (TCP/IP)**” then click [**Properties**] again and the Internet protocol property setting box is displayed.

WIRES X – The Bible



Figure 116 IPv4 Properties

12. Select **“Use the following IP address”**
13. Enter the IP address that was written down (step 8), e.g. 192.168.1.11
14. Enter **“255.255.255.0** as the sub-net mask address
15. Enter the IP address of the Default gateway; use the one recorded in step 8, 192.168.1.1, the router’s IP.
16. Enter the **“Preferred DNS server”** address; in this case we are going to use the Google DNS server address of **“8.8.8.8”**.
17. Enter the **“Alternate DNS server”** address, in this case we are going to use the Google DNS server address of **“8.8.8.4”** The end results appear as follows;



Figure 117 enter the new IP properties

18. Click **“OK”** and **[Close]** for each of the dialog panel that was previously opened.

WIRES X – The Bible

This completes the optimizing of the WIRES X PC. There are other things that can be done to prepare the WIRES X PC. There are a couple of documents located on the Internet that give you information for setting up the WIRES X PC for 7x24 operations. The documents are located on www.hamoperater.com. These are “[How to setup Windows 7 for 24x7x365 remote access](#)” and “[How to setup Windows 10 for 24x7x365 remote access](#)” on the WIRES-X Node Information.

You can now install the WIRES X Software on the PC that you prepared. It is recommended that you install the latest version of the WIRES X Software. The latest WIRES X software is located at Yaesu’s Website yaesu.com. Also download the latest “[WIRES-X Connection Kit HRI-200 Instruction Manual](#)”.

WIRES X – The Bible

Internet Connection (Port forwarding) specifically related to Actiontec FIOS Router

The WIRES X server communicates with the WIRES X PC via specified ports (46100, 46110, 46112, 46114, 46120 and 46122). When using the router to connect the WIRES X PC to the Internet, the UDP port goes through the router as well; communication using these ports is prohibited on the router as a default. We have to be sure the UDP ports are open for WIRES X traffic.

For this exercise and my configuration, I have an Actiontec MI424WR for Frontier FiOS internet and the following shows how I set up port forwarding for WIRES X. Among UPnP-compatible models, there may be some models whose port cannot open correctly and those whose UPnP functions have been turned OFF initially for security reasons.

1. Log onto the router and check to see if UPnP is enabled. If not enable it,



Figure 118 UPnP panel

The preceding shows that the UPnP is checked do not check anything else.

2. Assign the Port Forwarding Rule to the IP address that is assigned to the WIRES X PC IP.

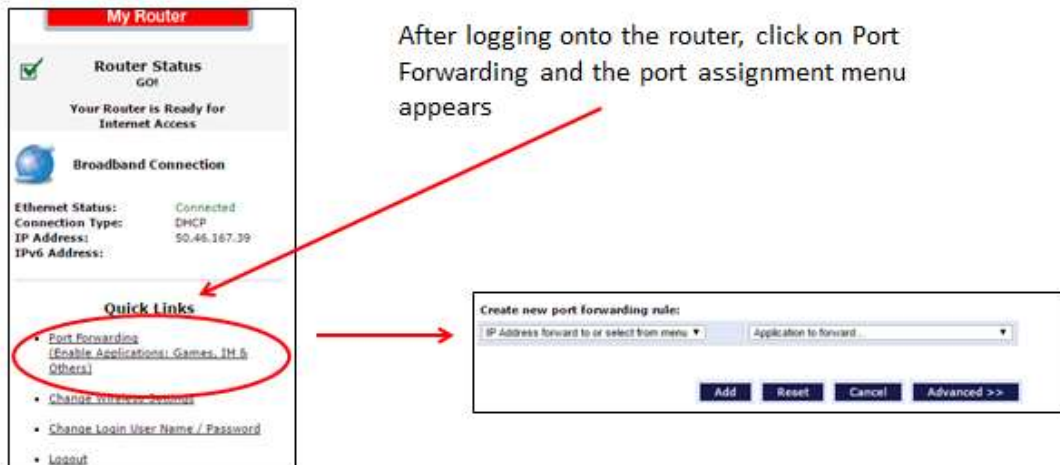

Figure 119 Selecting Port Forwarding

WIRES X – The Bible

Click on the pull-down and select “specify IP”.



Click on pull-down in this dialog
And select “Custom Ports”.



Click on pull-down in this dialog
And select “Custom Ports”.



Click on pull-down in this dialog
And select “UDP”.



Input the IP of the WIRES X PC and input the port to forward, e.g. 46100

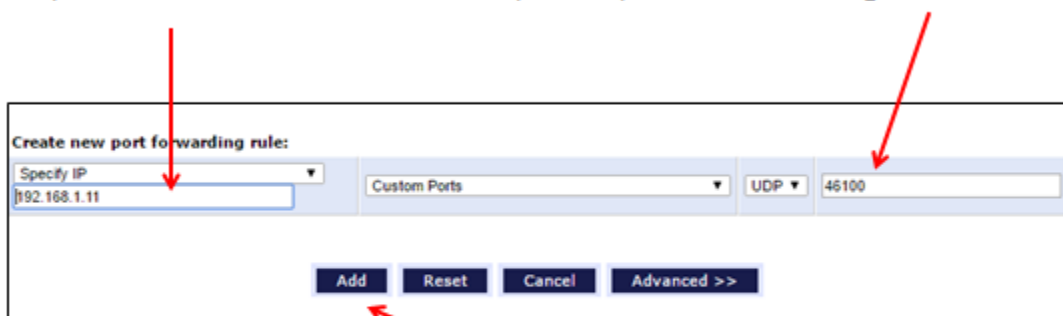

Then Click on “ADD”. After successfully adding the port, repeat the preceding for ports, 46110, 46112, 46114, 46120, 46122 and 47000.

When all ports have been assigned to the WIRES X PC check the Network Status of the router to verify that the required ports added, log out. This is a brief description for Port Forwarding on the Actiontec.

This completes the Port Forwarding for WIRES X. Refer to Yaesu’s [WIRES-X Connection Kit HRI-200 Instruction Manual](#) available from www.yaesu.com.

WIRES X – The Bible

Prepping the radio (FTM-100)

We prepared the computer and the router; now let's prepare the FTM 100DR. The FTM-100DR has to be to WIRES X mode, to become a node radio

The following is the process for setting the FTM-100DR as a node radio for WIRES X.

1. Press and hold  for over a second to turn OFF the FTM-100DR if it is on.

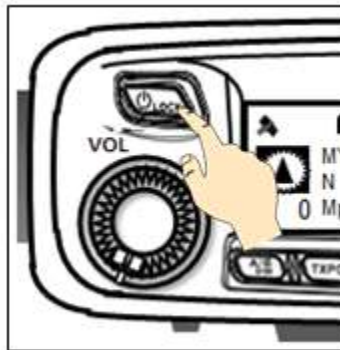





Figure 120 turn off FTM-100

2. While pressing  and  simultaneously, press and hold the  for over a second to turn ON the FTM-100DR. This sets the FTM-100DR to WIRES X node radio. To set the FTM-100DR back to a normal, follow steps 1 and 2.

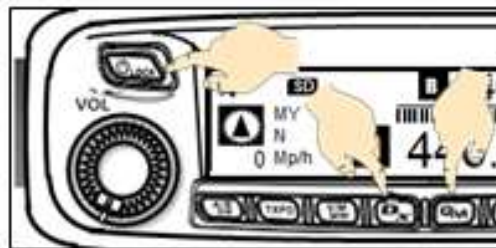





Figure 121 set to WIRES X mode

Note: Pressing and holding the  for over a second to hide all displays on the screen (the mode display and status indicator also are turn off). Press the  key again to turn hidden display back on. Pressing  each time switched the sub-band display: clock->power supply voltage->frequency.

WIRES X – The Bible

Prepping the HRI-200

Take the HRI-200 out of the box and side it aside. There not much to do to the HRI 200 until we connect it to the FTM-100DR and the WIRES PC. Once the HRI-200 is connected we can check to see if the firmware is up to dated.

Connecting it all up

Let's hook it up now that everything ready to connect up into a Local Node.

Complete the following to make a local node.

1. Find a suitable location to set up your node. Hopefully, away from your normal Amateur Radio operating location. But not so far away to be inaccessible, there are some things you may have to do to optimize the local node.
2. Set up the FTM-100DR in it permanent location with the proper antenna.
3. Connect the HRI-200 to the FTM-100DR using the 10-pin to 10 pin connector cable.

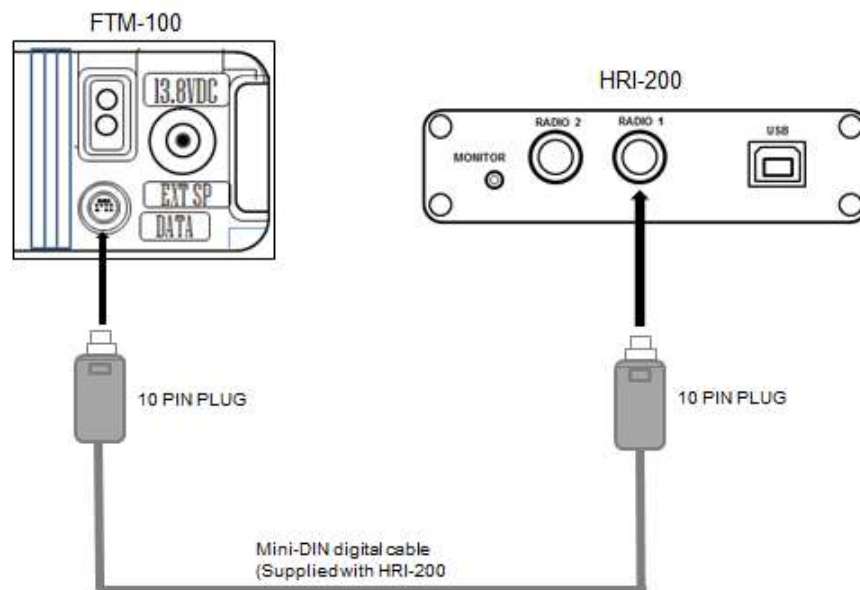

Figure 122 the FTM-100 to HRI-200 connection

Note: Yaesu provides two cables to connect the radio to the HRI-200, a 10 pin to 6 pin and a 10 pin to 10 pin. Plugged one end of the 10 pin cable into Radio 1 of the HRI-200; the other end of the 10 pin cable into the back of the FTM-100DR.

WIRES X – The Bible

- Now connect the HRI-200 to the one of the PIPO X8 USB port with the USB Type A to Type B cable (supplied with the HRI-200).

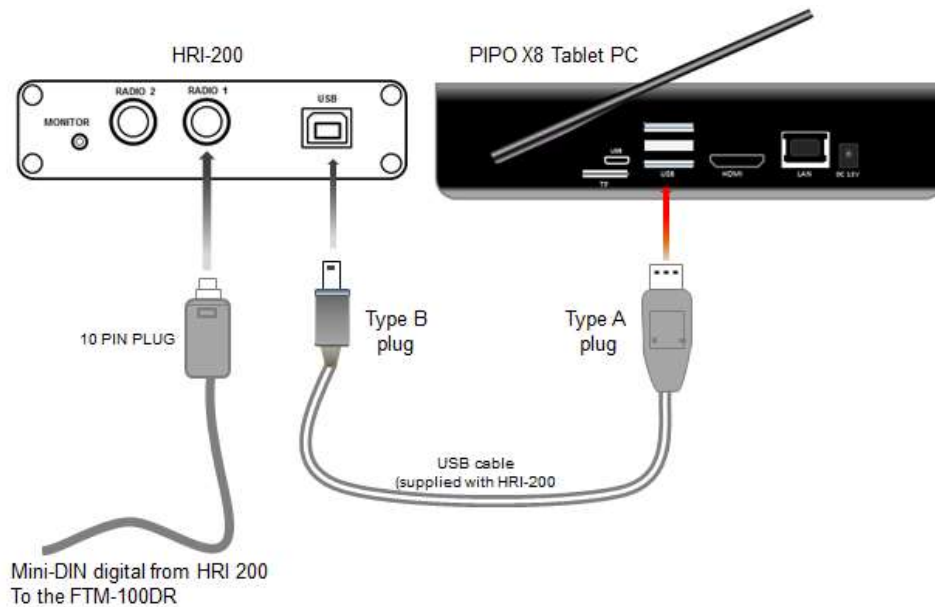

Figure 123 The HRI-200 to PC connection

Note: Yaesu supplies a couple ferrite cores that can be put around the USB cable at both ends of the cable. It is advised that you use these ferrite cores on the cable. If you did not have of these cores provided Yaesu, you can find the cores at any Electronic Supply.

- Next connect a Category 5 cable from the PIPO X8 Tablet PC to your Internet router.

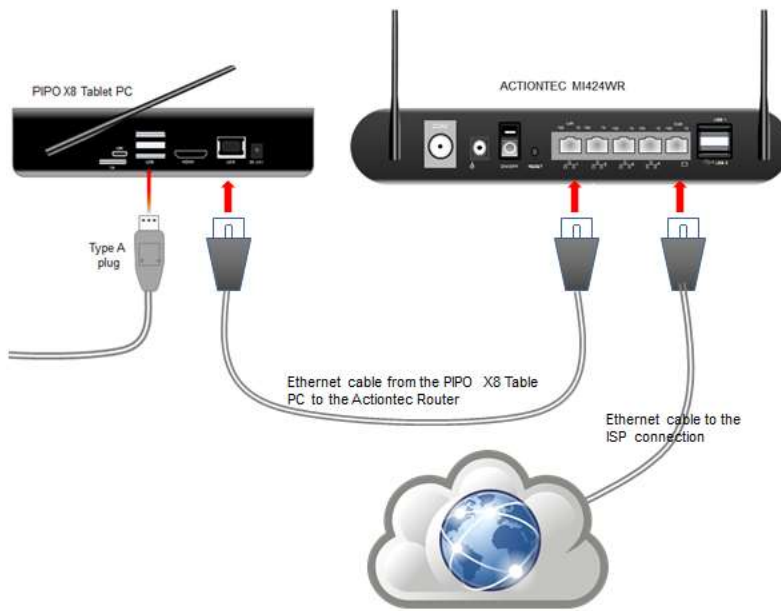

Figure 124 The PC to Router connection

WIRES X – The Bible

Finally to the Internet Service Provider

This is a local node hardware setup.



Figure 125 The WIRES X Local Node

This is what the hardware setup looks like after everything is connected. Your setup will look a little different depending on what you use for your setup.

WIRES X – The Bible

Installing the WIRES X Software

Now that we have all the hardware connected at ready to go...we can now install the software that runs WIRES X. Follow the steps to install the software on the PC.

1. If you have registered to get WIRES X node ID, go to www.yaesu.com/jp/en/wires-x/index.php to register.
 - a. Click “New Member Registration”
 - b. Enter your email address and submit it. You will promptly receive and email with an address for the website to complete the membership registration.
 - c. Visit the website and select “Apply for WIRES-X new ID (membership registration)”
 - d. Click [I Agree] on the “WIRES END-USER LICENSE AGREEMENT” Screen
 - e. Fill in the essential fields and submit

Once registration is complete, you should receive an email containing further details about your ID.

Note: it takes 2-3 business days for registration to be processed. Do not continue until you have an ID.

2. Go to Yaesu website and download the latest version of the [WIRES-X software](#).
3. Go to the download folder of your PC and click on the “wx1120en.zip” or whatever the current version of the software it at the time. Extract this file to folder of your choice.
4. Go to where you have extracted the software, for example;

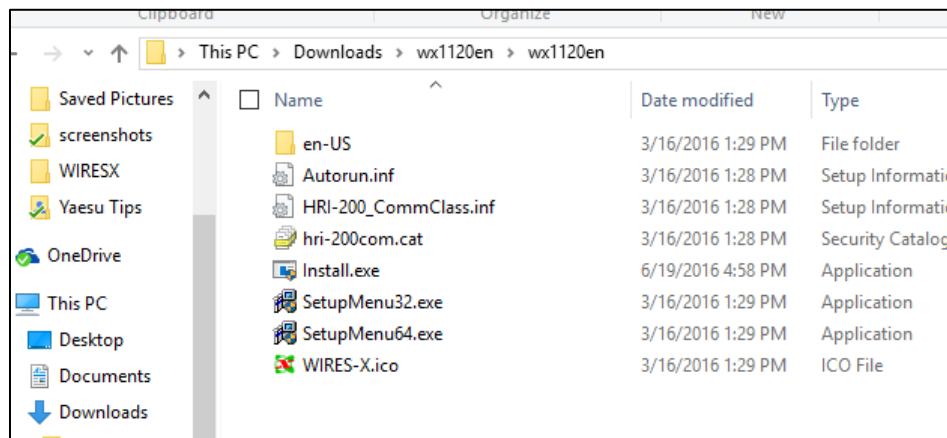

Figure 126 location of Downloaded WIRES X Software

This where I extracted the files from the default download folder and it create another folder call “wx1120en” which create a sub folder “wx1120en”. The sub folder is where the WIRES X install is located (as shown above).

5. Start the installation by clicking on “Install.exe” and this yields the following;

WIRES X – The Bible

The preceding in a prompt from Windows Security asking “are you sure you want to install this program”, of course you want to install this.

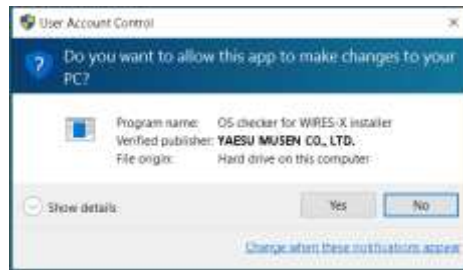

Figure 127 Security Prompt...Click Yes to allow

6. Click “Yes” to continue...and the following dialog is displayed.



Figure 128 installation dialog

This dialog gives you a choice of install the HRI-200 Driver or the WIRES X Software. If this is the first-time installation; we need to install the HRI-200 Driver.

7. Click on the “HRI-200 Device Driver Setup” and ...



Figure 129 Device Driver

This time the installation process is ask to confirm the installation of this driver. Check the box that says “Always trust...” and click on “Install”. When the driver has completed the install process, the main dialog for Install is redisplayed.

WIRES X – The Bible

8. Now click on the “WIRES X Software Setup” and ...



Figure 130 Confirmation

This is the confirmation for the WIRES X software setup dialog. Click “OK” to start the process. A couple more dialog boxes will appear; the license dialog and the destination dialog. Click to accept the license and click to accept the default program destination.

The installation process continues until the following dialog is displayed;



Figure 131 Installation Complete

This dialog show that the WIRES-X Software Setup has completed successfully.

WIRES X – The Bible

Configuring the WIRES X Software

Now we are ready to configure the WIRES X Software.

1. On the Windows desktop find the WIRES-X icon and left click on it. This starts the WIRES-X software and the following appears...



Figure 132 Firewall Dialog

Note: WIRES-X requires access to the Internet and has to go through the Windows Firewall. The Windows Firewall has detected that the WIRES-X software requires access to the Internet so it displays the preceding dialog asking whether or not to allow it access.

2. Click on “Allow access” to give the WIRES-X Software pass through the Windows Firewall. The next dialog appears prompting for the WIRES-X ID that’s registered at Yaesu.

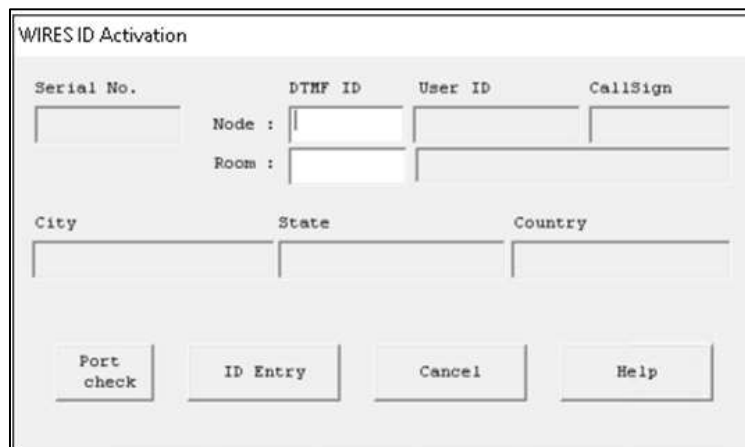

Figure 133 Registration panel

WIRES X – The Bible

3. Enter the WIRES-X ID (DTMF ID) and Room ID that was received from Yaesu. If you do not have that information, refer to step 1 in “Installing the WIRES-X Software”

Note: The WIRES-X Software will not start without this information.

4. After entering the WIRES-X. Click on “ID Entry” and after a bit the following is displayed showing that the WIRES-X Software has been successfully activated.

Serial No.	DTMF ID	User ID	CallSign
-----	Node : 11916	WB7OEV-ND	WB7OEV
	Room : 21916	WB7OEV-ROOM	

City	State	Country
Everett	Washington	USA

WB7OEV : ID Entry complete

Port check OK Help

Figure 134 Registration Confirmation

After activation is completed, your User ID, Callsign, City, State, and Country Information and saved to the computer and displayed on the screen shown in the example above.

5. After pressing [OK], the WIRES ID information settings screen is displayed as follows;

Settings

- Personal settings
 - WIRES ID information**
 - Location settings
 - Round QRO room settings
- Property
 - HRI-200 setup
 - Call settings
 - General settings
 - Digital ID settings
 - Make list file
 - Log file settings

WIRES ID information

Serial No.	DTMF ID	CallSign	User ID
51230034	11916	WB7OEV	WB7OEV-ND

City: Everett State: Washington Country: USA

Comment: _____

Confidential ID

QRL exchange (R1SE QVGA 320x240bmp)

Get info. text (MAX.200 characters)

OK Cancel Help

Figure 135 Registration information displayed

WIRES X – The Bible

6. Check over the settings click “OK” and the main screen is displayed ready to operate as a node. Then next thing that the need to be set is the transceiver parameters.
7. Click on “Files” then “Transceiver” to bring the parameter panel for the transceiver (node radio).

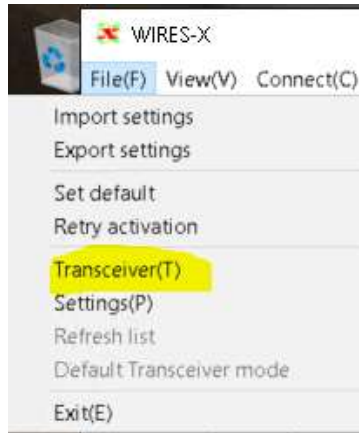

Figure 136 select transceiver settings

The Transceiver panel is use to set specific parameter for the local node. The default setting is for a Digital Node on a simplex frequency of 145.700 as shown below.

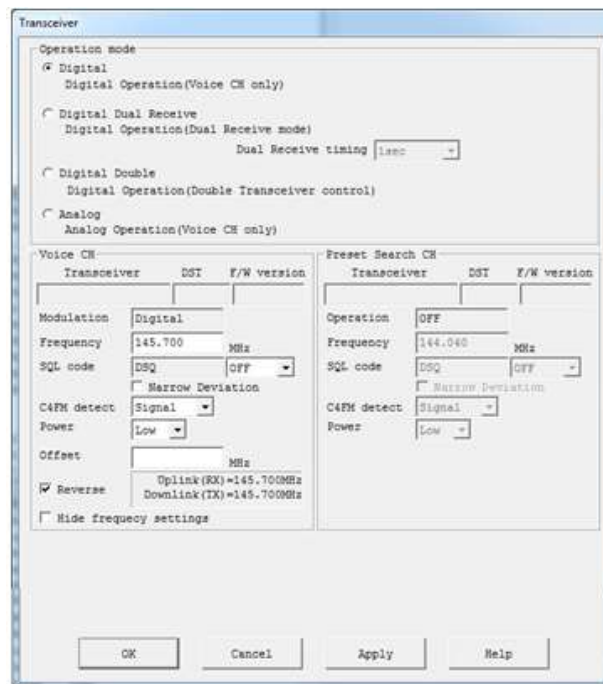

Figure 137 Transceiver settings

WIRES X – The Bible

This completes the initial configuration of a Local Node for WIRES X. Refer to Yaesu's WIRES-X Connection Kit HRI-200 Instruction Manual available at www.yaesu.com.

WIRES X – The Bible

Suggested Local Node Setting

The following are some suggested parameters to set to help in Local Node Operation.

1. Activate your Room.

At startup of the WIRES X Software the room that is assigned to the node is not active. If you want the room to be active, go to the “Settings” panel and click on the “Round QSO room settings” and...

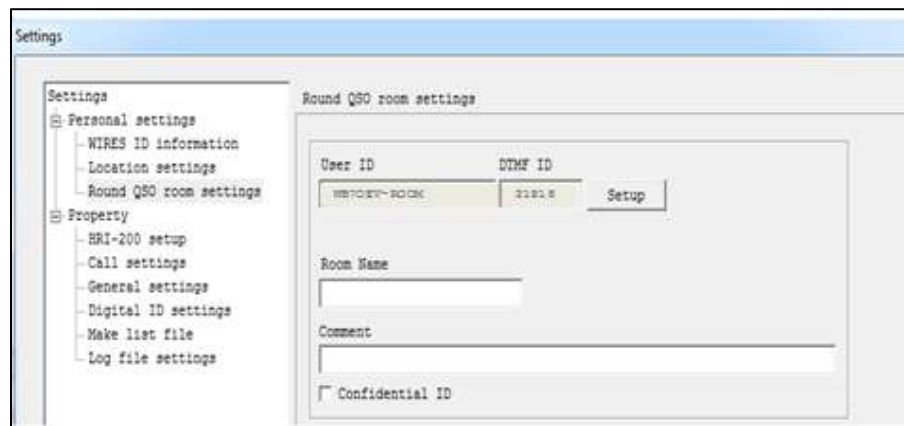

Figure 138 Room Settings

Click of “Setup” and the following appears...

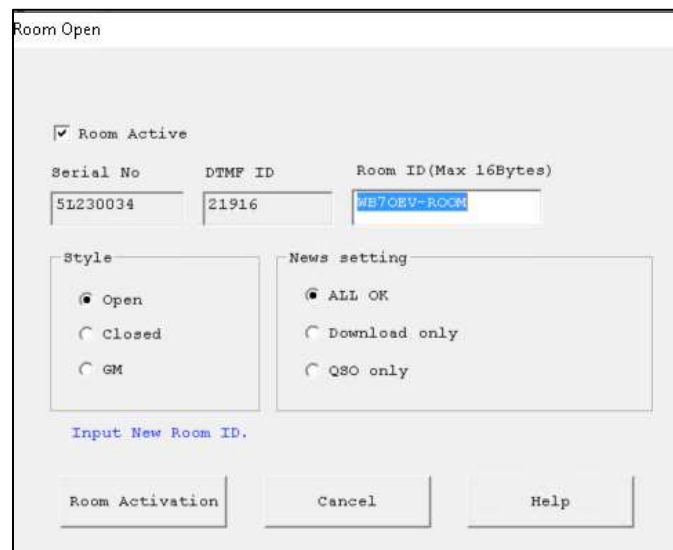

Figure 139 Room Activation

This is where you can rename the room and set how the room operates. The following is a brief description of the parameters.

WIRES X – The Bible

[Room Active]

Check here and press the **[Room Activation]** button to make your room operational.

[Serial No.]

The serial number of a confirmed HRI-200 is displayed.
(This field cannot be edited.)

[DTMF ID]

The DTMF ID of your confirmed room will be displayed.
(This field cannot be edited.)

[Room ID]

Your room's User ID (Room ID) is displayed.

Update your User ID by entering it here and clicking **[Room Activation]** button. (Up to 16 bytes)

If the User ID you enter is already being used an error message will appear. Enter a different new User ID if this happens.

[Style]

This is the operating style settings for the room station. Select a style that suits your purpose.

- Open: Select Open Room to set up a room that is freely accessible.
- Closed: Select Closed Room to set up a room that only members may access.
- GM: Select GM Room to operate a dedicated group management operation repeater room. A couple things to note about this style;

(Caution 1)

A closed room can only be accessed from a digital node where the members are registered. Also, only members' digital voice (DN) signals will be repeated. Repeating of VW (high-quality digital) voice signals and access from analog nodes is restricted. To set up a room that can be used from analog nodes and with VW signals, select Open.

WIRES X – The Bible

(Caution 2)

A GM Room can be accessed from a GM Node where the members are registered. All of the members' DN voices and DW signals (aside from images) can be repeated.

[News setting] optional

Select settings for access to your room's News function.

- **ALL OK:** It is possible to upload to and download from the mobile terminal.
- **Download only:** It is possible to download from the mobile terminal. Uploads are not allowed. Access is only possible by logging on through the computer display.
- **QSO only:** Do not operate the News function.

One exception is that in Emergency Voice mode the Upload and Download functions are enabled regardless of setting.

Click on “**Room Activation**” to activate your room and to register information to the server.

2. **Set a default Room** (a room to return to). Go to the “Settings” panel and click on “Call Settings” and set the following;

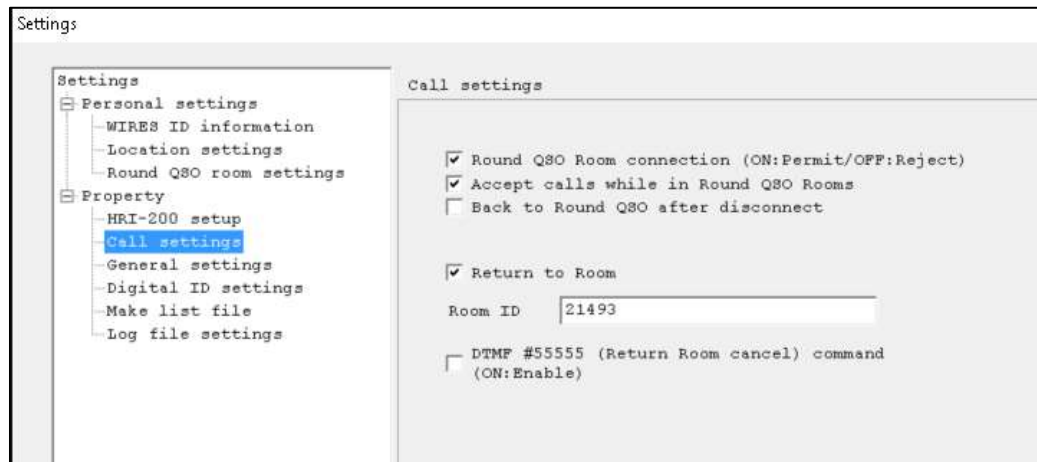

Figure 140 Call settings

[Round QSO Room connection]

Define the default response to requests to connect to the Round QSO Room here.

WIRES X – The Bible

[Accept calls while in Round QSO Rooms]

Define the default response when a connection request from another node is received while connected to the Round QSO Room.

[Return to Room]

Set the function for remaining permanently connected to a defined Round QSO Room as detailed below.

[Room ID]

Set the Round QSO Room to which you want to be permanently connected. (Either User ID or DTMF ID may be used).

Click “OK” when complete.

3. Set the “TOT” timer; go to the “Settings” panel and click on the “Round QSO Room settings” and...

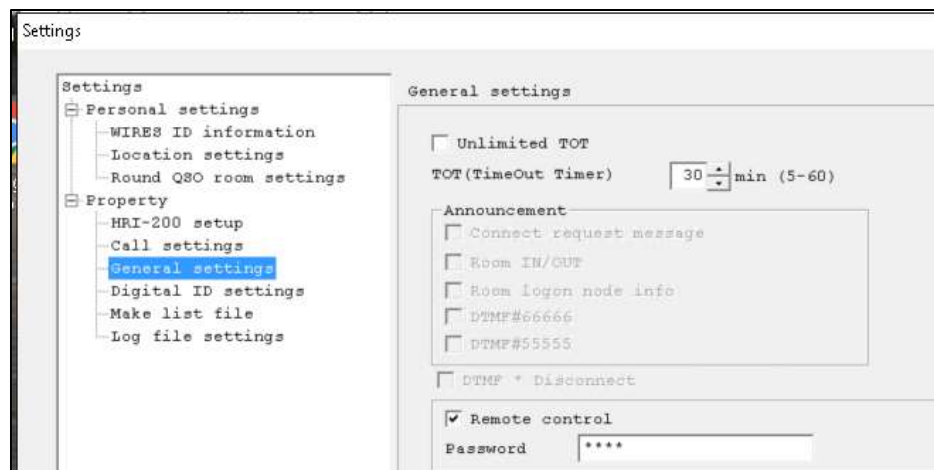

Figure 141 General Settings

[TOT (Time out Timer)] (Default = 10 min)

Set how long to stay connected to a node or room.

When the set time is exceeded, the device will automatically disconnect.

However, if the disconnect time comes during voice communication (while the INTERNET or ON-AIR lights are lit up), connection will be maintained until 20 seconds after voice communication has ended. Then it will disconnect.

WIRES X – The Bible

[Caution]

- The Time Out Timer only works when the inactive setting is OFF (timer active.)
- The timer is inactive when connected to the permanent connection room (Return to room function).

[Remote control] (Default = OFF) (Optional)

Turn the WIRES-X software (WIRES-X.exe) remote operation function ON and OFF here. When turned ON, access via the WIRES-X exclusive remote monitor software (WIRESMON-X.exe) is permitted. (Access is denied when set to OFF.

The special Web monitor plug-in must be set up in order to use the Web monitor function.

[Password]

Set the password for your WIRES-X exclusive remote monitor software (WIRESMON-X.exe)

The Return to Room and the TOT (Room timer) are handy for if you have a node that is available for all Amateur to use...others could navigate to a different room and forget to restore the room that it connected; this will allow the node to the base room when the Time Out Timer (TOT) expires.

The proceedings are some suggested parameter change for a Digital Local Node. Refer to Yaesu's WIRES-X Connection Kit HRI-200 Instruction Manual available at www.yaesu.com for additional information.

The following section described what I did to setup my local, this is basically is how to setup one up. This section is intended to give you an idea how to set up a Local Node. When you set yours up, you may use a different radio, different computer and your internet may differ.

Each Node that is created is different, but they all accomplish the same thing; Get you on the WIRES X Network.

WIRES X – The Bible

WIRES X Etiquettes

The WIRES X Network is a collection of local node and repeaters that's connected to the Internet. This means that being on the Internet; all nodes and repeaters connected; go through routers and switches and subject to all the latency that goes with it. So at time of communications with other nodes, there are times that transmissions may be delayed due to network conditions. This is especially true when there are many nodes that are in communication with each other, not to mention any other traffic that's normally uses the Internet. This latency could be a few milliseconds to up to a few minutes. There also could be lost transmission or even collision (also known a doubling) of transmission between nodes and repeaters.

In long and the short of it, we need observe a few rules when using the WIRES X Network to insure that transmission between nodes occurs in an orderly fashion and transmissions are not lost.

The following are some suggestion put together by **KOORK**¹ and others on what I refer to as WIRES X Etiquettes.

Good Operating Practices for Fusion Repeaters and Nodes, courtesy of BARS Fusion

1. Leave pauses between transmissions.

WIRES X Nodes and System Fusion Repeater linking is different than the normal analog repeaters and analog radios. For the reason describe in the preceding paragraphs, in is advisable not to **Quick Key**.

It is a good practice to leave a pause between transmissions (say 2 to 3 seconds). This gives others a chance to join in or announce their presence and let the linking between nodes to drop before keying up again.

On the MNWIS system, there is no courtesy tone so you must wait for the repeater to completely drop and pause for 2 to 3 seconds for all the links to un-key; otherwise, this could cause a repeater timeout.

When in a round table QSO, leave a little longer break to give others a chance to join in, and announce the break so that others in the round table know this is the time to let a breaking station to join in.

¹ Charles (Chuck) H Howard, K0ORK, put together the basic information for this section, thanks Chuck.

WIRES X – The Bible

2. Listen Before You Talk:

When preparing to use the repeater or node, be sure to listen before pressing the PTT. *Remember to key your microphone and pause for a second or two to insure that all the links to come up so that your transmissions are not cut off at the beginning.*² Also hold the PTT down for 2 to 3 seconds after you finish talking so all of your transmission is sent.

When you turn on your radio, check the volume setting to be sure you can hear any activity on the repeater.

3. Station Identification

All station should identify themselves using their FCC assigned Callsign upon: Initially transmitting on the repeater or node (this strongly suggested).

You should ID with your Callsign every 10 minutes thereafter, keeping in mind the nodes and repeaters on the WIRES X Network are a mix of Analog and Digital stations.

When ending a QSO, you need to use your Callsign to sign off.

4. Testing Repeater Access:

DON'T just key-up (kerchunk) the repeater without identify. Instead, use the term “Testing”, e.g. “This is ~~WB7OEV~~ Testing”.

If you want a signal report from another station, state that in plain English, e.g. “This is ~~WB7OEV~~, can someone give me a signal report?”

It is not a good idea to use the Repeater Frequency to check antenna SWR or to do other equipment checks. Move to a simplex frequency if possible or use a dummy load.

5. Demonstrations:

From time to time, an amateur may want to demonstrate the capabilities of amateur radio or local node to a non-amateur. The typical way to do this is to ask for a “demo” for example “This is ~~WB7OEV~~ for a demonstration.” Anyone whose listening to the

² This is true for rooms that host a large number of nodes and repeaters. Thanks to AI5AI, Don J Alsup

WIRES X – The Bible

Repeater can answer them. If you answer such a call, give the calling party your name, Callsign and location, not a lengthy conversation.

6. Making a Call:

Just say your Callsign to try to initiate a call.

Be clear and concise, Speaking in riddles or misleading language is poor operating practice.

Do not use the word “**break**” to join a conversation. Break is reserved for announcing emergencies.

If you are trying to contact a specific station, you should announce ... "<Callsign of station being called> - this is - <your Callsign>". Your Callsign is stated AFTER the station you want to call. If you do not get an answer after a couple calls, announce “<your Callsign> - clear”. This lets everyone else listening know that you have released the repeater for others to use.

If the repeater is already in use, please wait for a pause between transmissions to announce your call. If you want to contact another station not in the current conversation, ask if you can make a call in plain English. Simply announce Call Please or state, “<your Callsign> for a call”.

Make your call when the parties using the repeater turn the repeater over to you. If you contact the party you are seeking, turn the repeater back to the person who turned it over to you, thank them for letting you in, and move to another frequency to hold your conversation no matter how short you think it might take.

If you do not get a response from the party you are seeking, turn the repeater back to the person who turned it over to you, and thank them for letting you in.

When you hear someone making a call to a specific station it is not polite to jump in and put your Callsign out. Please be kind and let the calling station attempt to make contact to his/her specific station before putting your call out on the air saying you are listening.

7. Roundtables:

When a new station enters the roundtable, those stations using the repeater, and the next station in rotation should acknowledge the new station AND turn it over to them, or let them know what their place is in the rotation. Also indicate who they should turn it over to in order to keep the rotation intact. Remember to give your name as a matter of introduction so everyone becomes familiar with you!

WIRES X – The Bible

When in a roundtable discussion make it a practice to turn the repeater over to the next party in the conversation. Don't assume everyone will remember when it is their turn.

Not turning it over can cause confusion and instigates double-keying which does not play well in the digital world or repeater linking world.

8. Nets and Emergency Net situations:

When the repeater is running an Emergency Net or any type of net, all traffic will go through a net controller and all normal amateur uses will be suspended until the end of the net. Ask permission of the repeater trustees before running a net.

When running a net make sure to leave longer pauses to allow every repeater/node to catch up, 5-10 seconds every 3 or 4 rounds seem to work well.

The word “**break**” is reserved for announcing emergencies.

9. **Be mindful that you are representing all hams in a very large geographical area since our repeaters and nodes are linked country wide.**

On an average day there are 15 or more repeaters/nodes linked up. This can cover most of the US. Remember what you say will be heard in all these places. Is your conversation that important that the whole world needs to hear it?

10. Do not monopolize the repeater;

During drive times keep transmissions as short as possible.

The repeater/node is a shared resource.

11. Switching from one node/room to another:

If you are not the repeater or node owner please call on the radio asking for permission before changing the node or room linking. You might not be answered but it is courteous to ask first.

Please return it to the original node or room when you are done.

WIRES X – The Bible

WIRES-X Remote Control

The WIRES X software has a way of using the WIRES Webserver Plugin to allow you to control your node from a browser. The following describes how to set up the Plugin in the WIRES X Software;

1. From the main screen of the WIRES X Software, click “Tool(T)” and ...

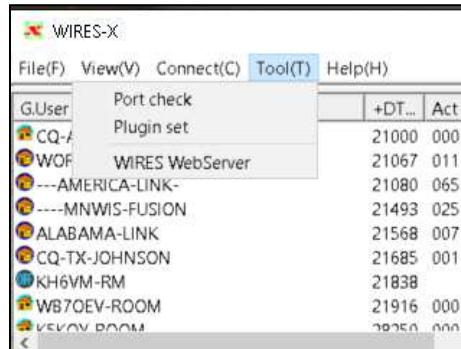

Figure 142 Select Plugin

2. Click on the Plugin Set and the following appears;



Figure 143 add module

3. Click on “Add Module” and you should see a single file in the following

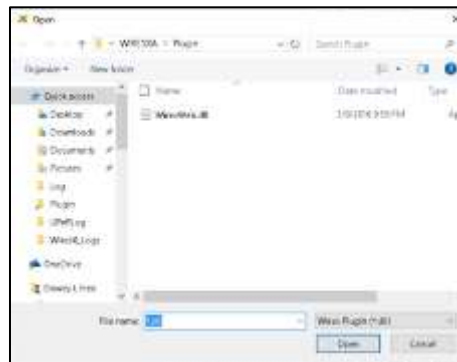

Figure 144 select file

WIRES X – The Bible

4. Double click on “WiresWeb.dll” to select and click on “Open” and you should see the following...

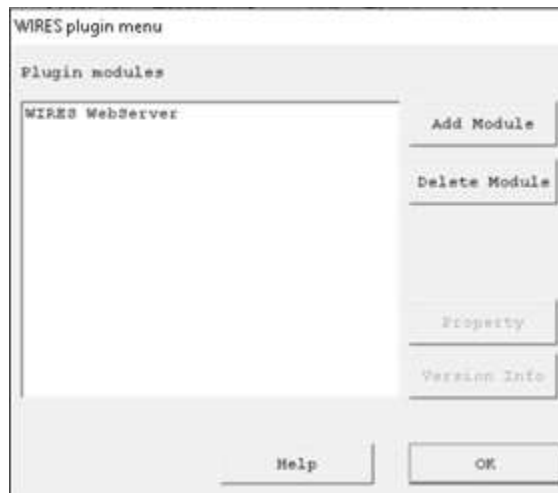

Figure 145 confirm ... click OK

5. Click on “OK” to install the WIRES X WebServer Plugin and the main screen of the WIRES X Software is displayed. Now we have to enable the WIRES X Software for remote monitoring from the web via the Web browser (preferably from a different PC).
6. From the main screen of the WIRES X Software, click “Tool(T)” and click on “WIRES X WebServer” and we see;

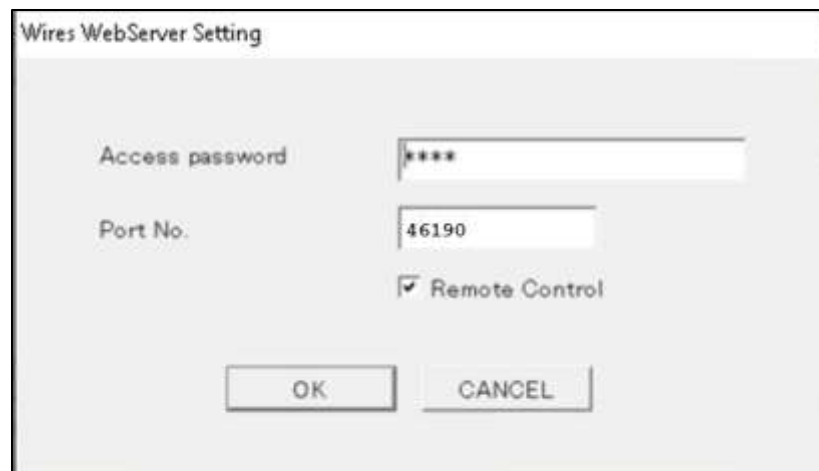

Figure 146 Set WebServer

Note: The access password is acquired directly from the password set in the remote control function set in the [File]-[Settings]-[Property]-[General Settings]; so it

WIRES X – The Bible

does not need to be set up in the plug-in screen. You can prohibit only the access by the Web monitor function by unchecking "Remote Control" box.

Note: **Caution**...When using this function, the port routing (port forwarding) setting of the TCP port* needs to be configured. This TCP port **cannot** be checked by the port check function. In addition, since it also cannot support the UPnP function, the port routing (port forwarding) setting needs to be configured in your internet router.

*The port that must be set (port forwarding in the router) is **TCP: 46190** (default value).

7. Check the General Settings panel to see if remote control is enabled, as shown in the following;

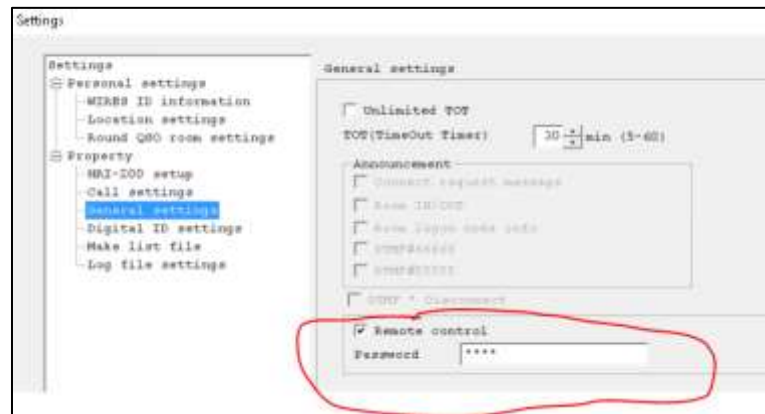

Figure 147 enable Remote control

If the Remote control box is not checked...check the box to enable and enter a password in the Password dialog window.

8. Click "OK" and the WIRES X main screen is displayed and WIRES X remote control is enabled.

If you have a PC that is not on your local net and you have a public IP that has a DNS name, the WIRES X Monitor Program can be used to monitor your node. The following shows how to use a URL to access the WIRES X node for remote operation.

The WIRES X plugin "WIRES WebServer" provides a web interface to the WIRES X software of the node. One can create a URL link that invokes the WIRES WebServer which serves up a page to the browser. To create the URL, we have to know three things about the node.

- The IP address of the WIRES X Node computer

WIRES X – The Bible

The IP address for the node PC that is on the home Internet, behind a router, isolated from the public. Basically, in order to access the node computer, you will have to know your public IP address. The easy way to find your public IP address is to Google it. Bring up your browser and go to Google and type in the search box this question, “how find your IP address” or something similar. You should see the search come back with your public IP address, e.g.

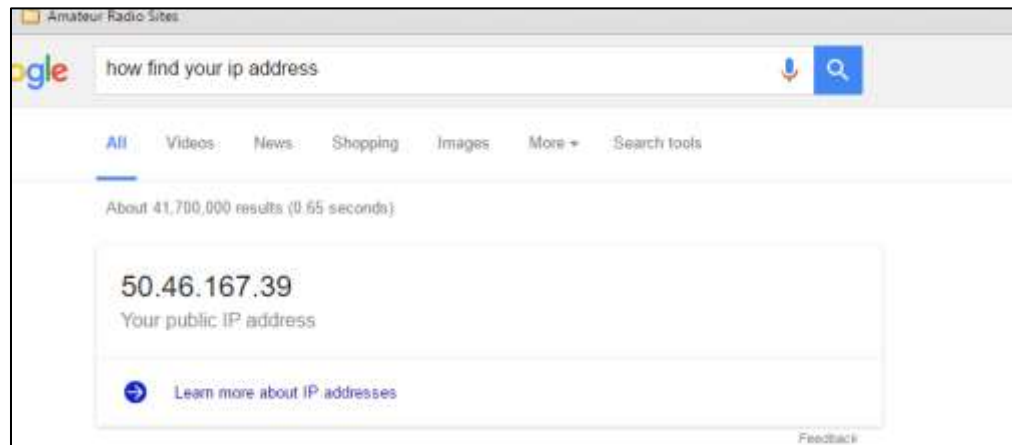

Figure 148 getting public IP address

- The Remote Port Address

This is the port that you assigned to the WIRE X Software and has been set up in your router to forward to the WIRES X node computer.

- The remote password

The WIRES X password that you enter for the WIRES X software on the node computer.

Now you have the three things you need to know for setting up a URL. The URL is in the following format;

`http://<Public IP address> : <port number>/?wipassword=<your password>`

The URL would look like this....

`http://50.46.167.39:46190/?wipassword=3372976%wirex`

WIRES X – The Bible

Start your browser and put the URL in the address line and the following appears.



Figure 149 WIRES X WebServer

This shows the status of the node and you see several links you can use to control the node. Most of the links are read only, which if you click on them; information of each link is displayed. There are two links that actually allow you control of the node;

The [**Lock/Unlock**] button

When you press this button, this inhibits the node radio (disables transmit) and if the node is connected to a node or room, the node or room is disconnected. The web page updates to change the [**Lock**] to [**Unlock**]. This is to disable the Node Radio's transmit. Pressing the [**Unlock**] enables the Node Radio's transmit and if you have "return to room" set, the node reconnects to the designated room and updates the web page to [**Lock**].

The [**Room Info**] link

This link gives you the status of the node's room; gives you the ability to mute/unmute nodes and rooms connect to your room. This link also allows you to remove or reject a node/room from your room.

Note: Clicking on "WIRES-X Ver-1.120" refreshes the page back to the original page.

WIRES X – The Bible

Once you have your URL set up, you can set up a shortcut on your desktop to take you to the page directly from the desktop.

This URL can be used from an IPAD, tablet or a Smart Phone.

I don't what application on Apple that you would use to put a URL on your home screen, but I am sure there's app in the Apple Store. Android does have several apps in the Play Store that puts a widget on the android's screen, just search for "URL widget" and pick the one that works for you.

Warning:

There's security risk in using this method, the wires x remote password is sent out as plain text, be warned. Also, don't use the default port suggested by the wires x software, use something in the 50000 range. The security is still not perfect, so use this method with care.

There is also a danger of your public IP address being change by your Internet Provider, because they use DHCP to assign an address. So depending how long the set their time to renew the IP address, the Internet Provider could assign a new IP address when the time expires.

WIRES X – The Bible

WIRES X Port Information (additional information)

The communication port check function checks whether the WIRES-X software (WIRES-X.exe) can communicate correctly with the WIRES-X control server from YAESU MUSEN and the WIRES-X Node/Room established and operated by other amateur radio stations.

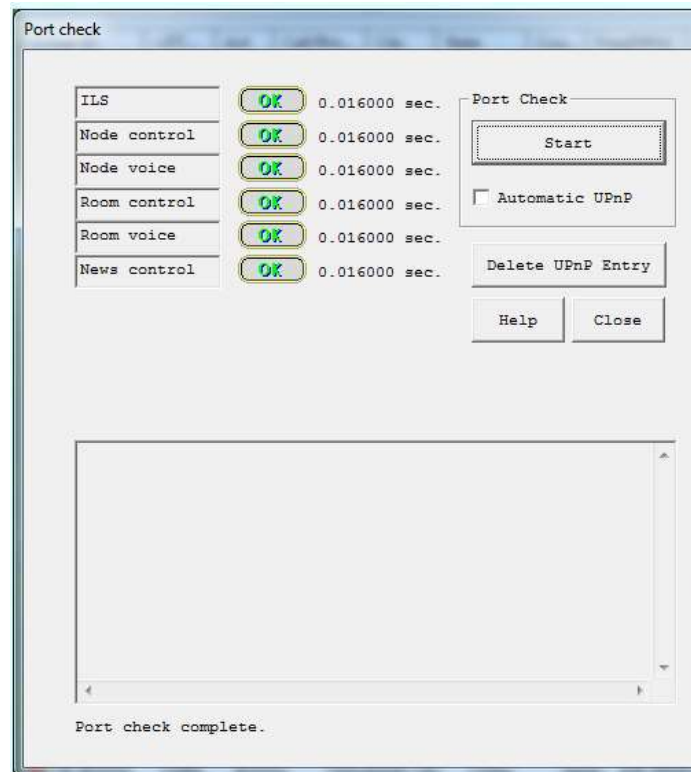
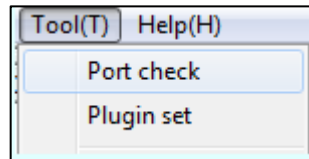

Figure 150 WIRES X Port Status

In an Internet environment which uses a router fitted with an UPnP function, the UPnP information for the router can also be set from this screen.

WIRES X – The Bible

(Explanation of the screen)

ILS	OK	0.093000 sec.
Node control	OK	0.093000 sec.
Node voice	OK	0.093000 sec.
Room control	OK	0.093000 sec.
Room voice	OK	0.093000 sec.
News control	OK	0.078000 sec.

Figure 151 Ports Status Green

Communication is carried out using 6 UDP ports in WIRES-X and the communication state is checked and displayed for each communication port.

ILS: Check receipt of control signal (list information etc.) from the WIRES-X control server.

Node control: Check control signal path to the Node (PTT, Digital data, etc.).

Node voice: Check the voice signal path to the Node.

Room control: Check the control signal path to the Room (PTT, Digital data etc.).

Room voice: Check the voice signal path to the Room.

News control: Check access to News.

Common to all the UDP ports, **OK** is displayed if communication is possible and **NG** is displayed if not.

If there is any NG displayed, check whether there are any mistakes in the settings since it is possible that a malfunction may have occurred somewhere.

(Caution) In the port check screen, the TCP port used in the Remote Monitor (remote control function) cannot be checked.

WIRES X – The Bible

[Start] button

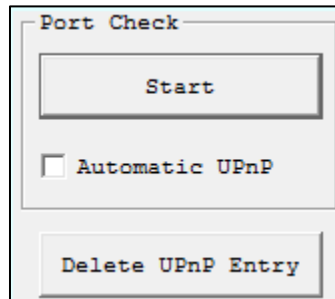

Figure 152 Port Status Test

Press the Start button shown above to run the communication port check process.

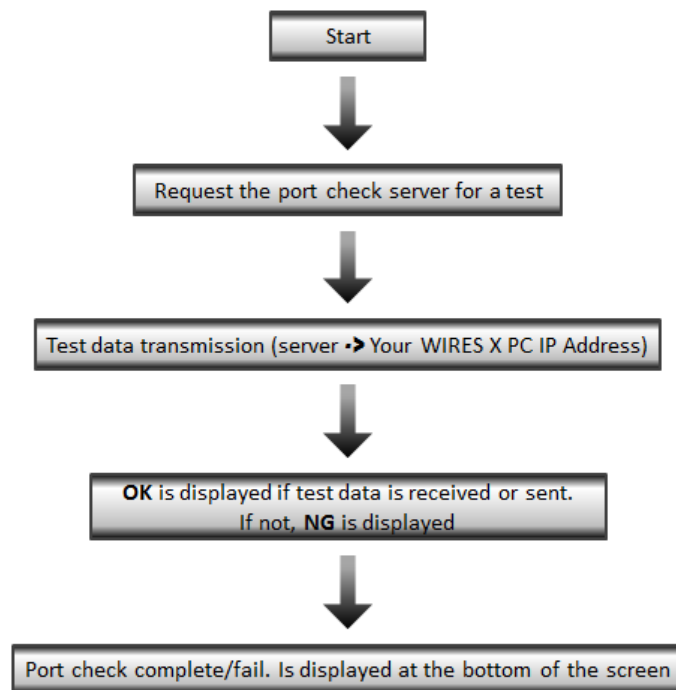

Figure 153 Port Status Sequence

Normally, the WIRES-X software automatically performs a port check immediately after start-up and every hour thereafter, so the state is displayed simply by displaying the port check screen. Press the Start button to run the test immediately and display the results.

WIRES X – The Bible

[Automatic UPnP]

In the case of an Internet environment which uses a router equipped with an UPnP function, the port routing (opening) setting can be carried out using the UPnP function by putting a check to it.

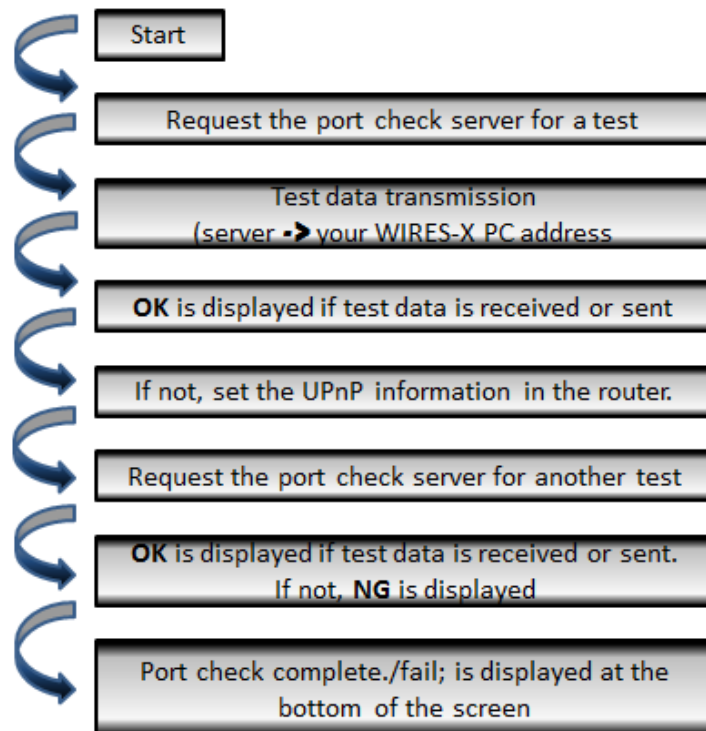

Figure 154 Port Status Test

If a port check is carried out with the UPnP automatic registration checked, in the event the communication path had not been secured, the port routing (opening) setting is carried out automatically by the UPnP function.

[Delete UPnP Entry]

Press the button to delete (cancel) the UPnP information set in the router.

WIRES X – The Bible

Additional Information (Precautions regarding the UPnP function)

1. When the UPnP automatic registration is checked, the UPnP information will be reset as well if a NG were to appear in the port check carried out immediately after startup and every hour thereafter. (If the result is OK, the UPnP information will not be reset.) If the result is always NG, the situation may return to normal by starting the router again.
2. The UPnP information set in the router can be deleted from the WIRES-X software by pressing the UPnP registration cancellation button. However, there may be some router models which prohibit communication of the deleted UPnP port whose registration has been cancelled.

Note: If UPnP registration cancellation is carried out, be sure to start up the router again.

3. Among UPnP-compatible models, there may be some models whose port cannot open correctly and those whose UPnP functions have been turned OFF initially.

If the function does not work properly, *check whether the UPnP function of the router has been turned **ON**.*

If the function does not work even when turned **ON, uncheck UPnP automatic running in the port check screen and configure the port routing(opening) settings (NAPT etc.) from the router setting screen.**

4. If the UPnP function is used at the same time in an environment in which the port routing (opening) settings (NAPT etc.) have been configured in the router, the port may not be released correctly due to a conflict in the mutual settings. When using the UPnP function, we recommend that the port routing (opening) setting (NAPT etc.) on the router side be cancelled beforehand.

WIRES X – The Bible

Port routing (opening) and setting point

1. Port routing (opening) setting point

In order to perform WIRES-X operations, the PC for WIRES-X use needs to be capable of communicating with other stations on the Internet (WIRES-X servers from YAESU MUSEN and WIRES-X stations established by other customers).

Configure the following communication settings as preparation to enable communication.

- IP address setting (fixed IP address) of PC for WIRES use.
- Communication permission setting of firewall software in the PC.
- Port routing (opening) setting of router device.

2. IP address setting of PC for WIRES-X use

First, fix the IP address (information equivalent to the address on the network) of the PC for WIRES-X use.

Note: In a general Windows PC, the IP address is set to be automatically assigned by the DHCP (Dynamic Host Configuration Protocol) function that the router is equipped with.

For the automatic assignment setting of the IP address, a different IP address may be assigned every time the PC is started up. This may be different from the routing setting for the router that is described later, leading to the possibility that operations may not work correctly. In order to avoid this, fix the IP address and ensure the router setting works correctly at all times.

See Section “Assign a Static IP to the WIRES X PC”.

WIRES X – The Bible

Firewall setting of PC software

Firewall software is installed as a standard feature in PCs running on Windows Vista or later. When the WIRES-X software is started up for the first time, a message regarding communication block is displayed by the firewall software. Configure the system to permit communications to be carried out.

(The method to block communications using the standard Windows firewall function is indicated below.)

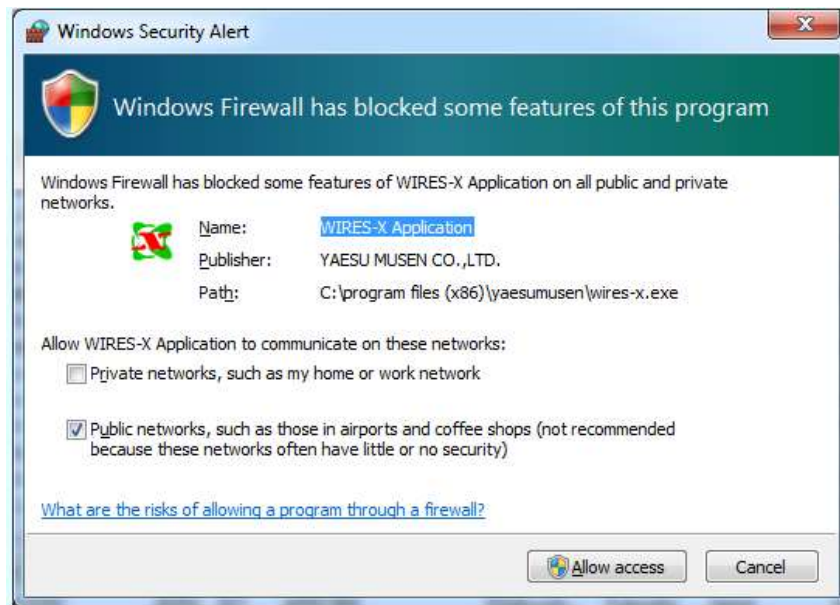

Figure 155 Firewall Prompt for WIRES X access

Click [Allow Access] button.

WIRES X – The Bible

Port routing (opening) setting to the router

In WIRES-X, two methods of configuring the router are assumed.

- One method is to directly control the router from the WIRES-X application using the UPnP function of the router.
- The other method is to configure the routing beforehand using the port/address conversion function of the router.

The UPnP function can be used very easily and can be set simply by operating the [Automatic UPnP] item. However, there are also some models that do not work with the UPnP function. In this case, configure the routing settings in the router as described below.

(Explanation)

In a general Internet environment, a device known as a router is installed between the Internet line and PC. Normally, this router cuts off communication data coming in from the Internet line.

To perform WIRES-X operations, there is a need to configure the settings in the router so that communication data can be delivered correctly to a PC for WIRES-X use without cutting off the communication data for WIRES-X that comes in from the outside. An entry and exit point (door) known as a port between the Internet line (WAN side) and the internal side (LAN side) is prepared in the router and a number is allocated to each port (entry and exit point).

In addition, an entry and exit point known as a port is also prepared similarly for PCs with an Internet connection function (LAN) as well.

The port number (entry and exit point) used by WIRES-X is determined in advance.

- UDP port: 46100, 46110, 46112, 46114, 46120, 46122

When utilizing the remote control function using the remote monitor (web monitor function), the following port can also be used at the same time.

- TCP port: 46190 (initial value)

We configure the settings in the router so that the data between the local IP address (LAN side) on the WIRES-X PC and the outside world (WAN side) is routed through this port number (entry and exit point).

WIRES X – The Bible

The name and configuration method for the routing settings differ depending on the model of the router.

For various router models, the functional names are similar to those indicated below.

(Functional notation examples)

- * NAT
- * IP masquerading
- * Port mapping
- * Port/Address conversion
- * Port forwarding
- * Port opening
- * Virtual server
- * others

Search for settings similar to those in the functional notation examples mentioned above from the instruction manual of the router used and perform the routing settings of the port number used in WIRES-X.

WIRES X – The Bible

WIRES X Terminology use by the Amateur Community

- Buffering This is when several WIRES X Station transmissions are received sequentially with no spacing between transmissions. The best indication of buffering is when the WIRES X station deliberately leaves a pause before the next WIRES X station transmits and there is no space before the next WIRES X Station transmits.
- Latency the time between actual transmission a signal and when the signal is hear.
- Link Radio The C4FM type radio use in a local node,
- R2-D2 Distorted audio signals on WIRES X that sound like the voice of the StarWars character.

WIRES X – The Bible

Setting the DSQ code

The Yaesu Fusion radio uses the DSQ for digital communications. This is basically a two-step process to set the DSQ, setting the SQL Type and setting the SQL CODE.

The following goes through the step of setting the DSQ for digital communications.



Set the squelch to for the digital mode (DSQ) for FT1D and the FT1XR

Note: This is a Global setting.

1. Press and hold the **DISP** for over a second.
2. Turn **DIAL** to select item 2 [**TX/RX**]
3. Press **ENT**
4. Turn **DIAL** to select again, item 2 [**DIGITAL**]
5. Press **ENT**
6. Turn **DIAL** to select item 2 [**SQL TYPE**]
7. Press **ENT**
8. Turn **DIAL** to select [**SQL TYPE**]
9. Press **ENT**
10. Turn **DIAL** to select squelch type
 - OFF:** Voice is always output upon receiving a digital signal from a Yaesu transceiver
 - CODE:** Voice is output only when receiving a signal with the corresponding **SQL CODE**
 - BREAK:** Voice is output regardless of the squelch code that's set when a digital signal is received
11. Press **ENT**
12. Turn **DIAL** to select [**SQL CODE**]
13. Press **ENT**
14. Turn **DIAL** to enter the code
 - Enter the **SQL CODE** of **001** to **126**
15. Press **PTT** to save the **SQL CODE** and exiting the Set Mode



Set the squelch to for the digital mode (DSQ) for FT2D

1. Press the **DISP** for over a second
2. Touch [**TX/RX**] button

WIRES X – The Bible

3. Touch item 2 [**DIGITAL**]
4. Touch item 1 [**SQL TYPE**]
5. Turn the **DIAL** to select [**SQL TYPE**] the press DISP key
6. Turn **DIAL** to select the desired squelch type
 - Off:** Audio is always output when receiving a digital signal
 - CODE:** Audio is output only when receiving a digital signal with the corresponding **SQL CODE**
 - BREAK:** Audio is output regardless of any squelch code set in the signal from another station
7. Press **BACK**
8. Turn **DIAL** to select [**SQL CODE**], then press **DISP**
9. Turn **DIAL** to select the desired code
 - Select **SQL CODE** from **001** to **126**.
10. Press **BACK** several time to exit the setup mode



Set the squelch to for the digital mode (DSQ) for FTM100

The Digital Squelch type

1. Press DISP/SETUP for over a second
 - Wait for the Setup Menu to appear
2. Turn **DIAL** to item 2 [**TX/RX**] then press **DISP/SETUP**
3. Turn **DIAL** to item 4 [**DIGITAL SQL TYPE**] then press **DISP/SETUP**
4. Turn **DAIL** to select the desired squelch type
 - Off:** Audio is always output when receiving a digital signal
 - CODE:** Audio is output only when receiving a digital signal with the corresponding SQL CODE
 - BREAK:** Audio is output regardless of any squelch code set in the signal from another station
 - Note:** The default setting is 1: Off
5. Press **DISP/SETUP** over a second
 - This sets the squelch type and returns the display to the previously viewed screen

Setting the DSQ Code

1. Press **DISP/SETUP** for over a second for the setup menu
2. Turn **DIAL** to item 2 [**TX/RX**] then press the **DISP/SETUP**
3. Turn **DIAL** to item 5 [**DIGITAL SQL CODE**] then **DISP/SETUP**.

WIRES X – The Bible

4. Turn **DIAL** to select the desired code
The code selection is from **001** to **126**
The default setting is 001
5. Press the **DISP/SETUP** for over a second
Sets the squelch code and returns the display to the previously viewed screen

WIRES X – The Bible



Set the squelch to for the digital mode (DSQ) for FTM400

The squelch type in digital mode doing the following;

1. Press DISP/SETUP for over a second and the setup menu appears.
2. Touch [TX/RX]
3. Touch [DIGITAL]
4. Touch item 2 [SQL TYPE]

The squelch type changes in the follow order each time the symbol is touch
“OFF” → ”CODE” → “BREAK”

Off: Audio is always output when receiving a digital signal

CODE: Audio is output only when receiving a digital signal with the corresponding SQL CODE

BREAK: Audio is output regardless of any squelch code set in the signal from another station

Note: The default set to off

5. Press DISP/SETUP for over a second
The squelch type is set and the display returns to the main screen

Setting the squelch code of the digital mode by the following steps;

1. Press DISP/SETUP for over a second and the setup menu appears.
2. Touch [TX/RX]
3. Touch [DIGITAL]
4. Select and touch item 3 [SQL CODE]

The characters of the set value turn orange in color

5. Turn DIAL A to select the code
The code selection is from 001 to 126
The default setting is 001

6. Touch item 3 [SQL CODE]
The character of the set value turns green

7. Press DISP/SETUP for a second or longer
The squelch code is set and the display returns the main screen

WIRES X – The Bible



Set the squelch to for the digital mode (DSQ) for FT-991

In order to set the DSQ on the FT-991, we have to use the customization capability to set the DSO mode. The menu items are grouped by numbers from **001** to **151**.

In the case we are only interested in item **88, DIGITAL SQL TYPE** and **89, DIGITAL SQL CODE**.

Use following to access items 88 and 89.

1. Press **MENU (SETUP)** button to access the Menu Mode.
The display shows the Menu Number and the Menu Item.
2. Turn the **MULTI** knob to the Menu item to be modified, in this case 88
3. Touch **[SELECT]** on the LCD, then turn the [MULTI] knob to change the current setting of the select item.

Item 088 DIGITAL SQL TYPE

Function: Sets the squelch type in digital mode

Default Setting: OFF

Description: Selects the squelch type in digital mode.

OFF: Audio is always output when receiving a digital signal

CODE: Audio is output only when receiving a digital signal with the corresponding SQL CODE

BREAK: Audio is output regardless of any squelch code set in the signal from another station

Item 089 DIGITAL SQL CODE

Function: Sets the squelch code for digital mode.

Available Values: 001 -0126

Default Setting: 001

4. When the adjustment or settings are completed touch **[ENTER]** on the LCD to save the new setting, then touch **[BACK}** to exit the Menu Mode.
5. Repeat steps 1 through 4 for item 89

WIRES X – The Bible



Set the squelch to for the digital mode (DSQ) for FTM 3200DR

The FTM 3200DR Setup (Menu) mode is use to configure any of the transceiver's parameters, such as the DSQ, items 13 and14.

To access the Setup (Menu), do the following;

1. Press the [**MHz/SETUP**] for over a second to enter the Setup Menu.
2. Turn the **DIAL** to select the Menu item to be adjusted, items 13 or14.
3. Press the [**MHz/SETUP**] momentarily to enable the adjustment of the selected Menu item 13 then turn the DAIL to perform the adjustment.

Item 13: DSQ CODE

Function: Set the squelch code in digital mode.

Available Values: Codes 001 to 126.

Default: Code 001.

Item 14 DSQ TYPE

Function: Sets the squelch type in digital mode.

Available Values: CODE/BREAK/OFF.

Default: OFF

- Off:** Audio is always output when receiving a digital signal
- CODE:** Audio is output only when receiving a digital signal with the corresponding SQL CODE
- BREAK:** Audio is output regardless of any squelch code set in the signal from another station.

4. After completing the selection and adjustment, press the [**MHz/SETUP**] for over and second to exit the Setup menu.
5. Repeat steps for item 14.

WIRES X – The Bible

Finding a Local Node

There are other tools that one can use to locate a Node that is nearby for instance, fusionlive.net. This website displays real-time map of **ACTIVE** Wires-X Nodes so that when you travel and you can always find a Node to connect.

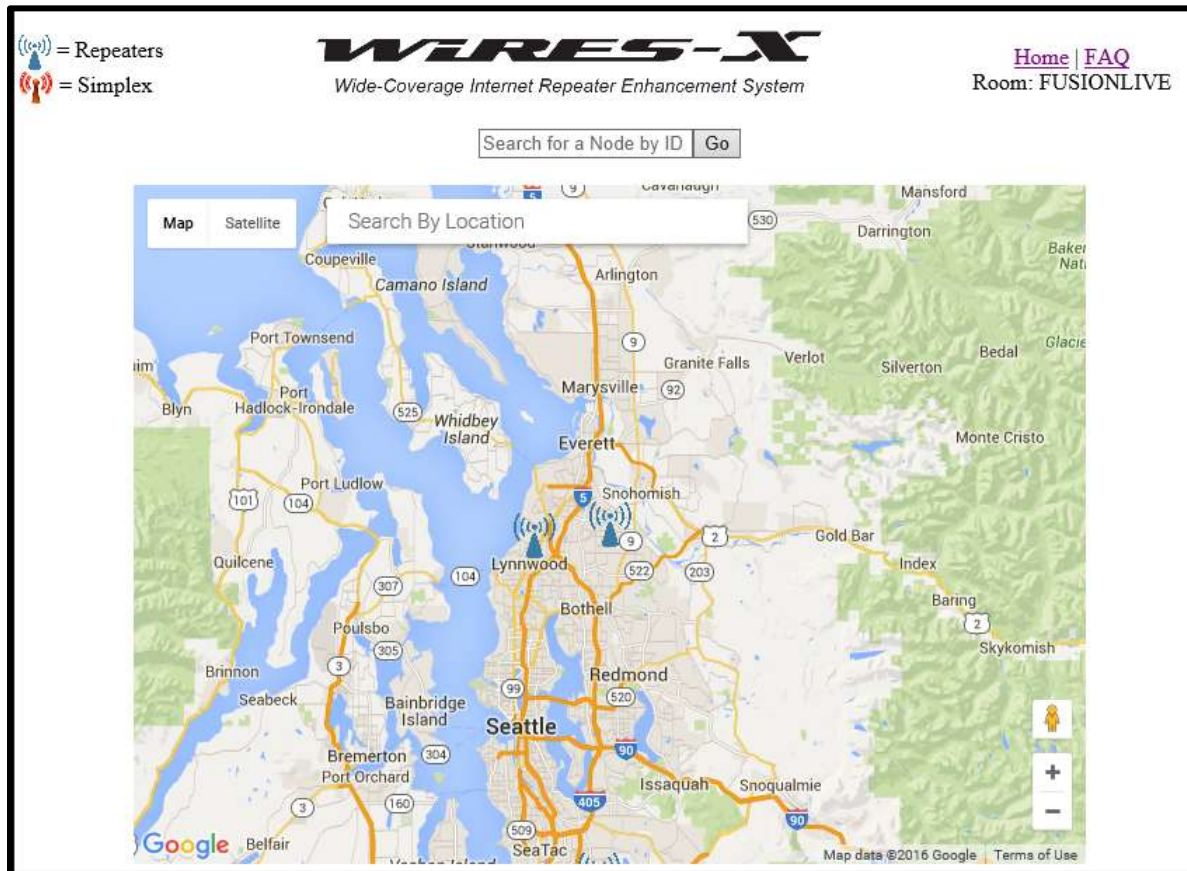

Figure 156 Fusion Live Net Tool

This is a handy tool that will help you find a nearby local that you can connect to. This tool is designed to be used from a smartphone. If you have your location service turned on the phone the map automatically update to your location showing all the publicly listed active local Nodes in your location. If you need to list active local Node in a particular location, type in the city and state in the search field, the FusionLive³ Web page displays a map of the location specified, showing active local Node in the area. If you know the Node id of your desired Node, type into the Node search field the click on “Go”, the page update to the location of the specified active Nodes.

³ [Fusionlive.net](http://fusionlive.net) is a private effort developed by Eric J. Goforth, N6GOF. We like to thanks to Eric for developing this tool.

WIRES X – The Bible

References

www.hamoperator.com

www.fusionlive.net

www.google.com

www.microsoft.com

www.Yaesu.com

www.socalham.com

[The Woodford Repeater Association](#)

[MARA repeater system](#)

[Repeater Etiquette](#)

Appendix

What is DSQ?

First of all, what is DSQ? I am really not sure. I am going to use the definition that was interpreted by Chris Petersen, K9EQ.

“An open-DSQ repeater repeats the DSQ. That allows multiple users to select different DSQ's so they don't have to hear other stations if they don't want to. DSQ is transmitted through the network, thus DSQ can be used across networked systems to allow for selective calling...”⁴

This is only definition that seems to make scene...based on that I found this theory of operation from another document “DJ160.3” of which I found on the internet.

‘DSQ Squelch Theory of Operation:

Receive Mode: DSQ squelch is used to cause the radio to be silent (squelched) while in receive until it receives a three digit code. IF it receives the correct three digits during the first second or two of a transmission, it will release the squelch and receives the transmission.

Transmit Mode: When used to transmit, the radio will automatically transmit the three digit DSQ group code right after you press the [PTT] button, so remember to pause a moment before talking if using the radio in DSQ mode.’

⁴ Taken from “Open letter to the Minnesota Repeater Council” by Chris Petersen, K9EQ

WIRES X – The Bible

RF Linked Repeaters Parameters

Connecting the DR-1X Repeater to the Internet can be easily accomplished and all you need is a local node set up within communication range of the DR-1X repeater. That node is used to link the C4FM Digital or Analog signal remotely to the DR-1X repeater thereby providing an Internet link to the WIRES X Network

The setup for an RF Linked Repeater node is the same as the setup for a local node with the exception of the Transceiver settings. Instead choosing a simplex frequency for the Local Node, you set the transceiver setting to the frequency for the repeater that you want to link to...for example;

In the Yaesu Wires X software on the Node PC;

1. Bring up the Transceiver Panel by clicking file->Transceivers and the following is displayed;

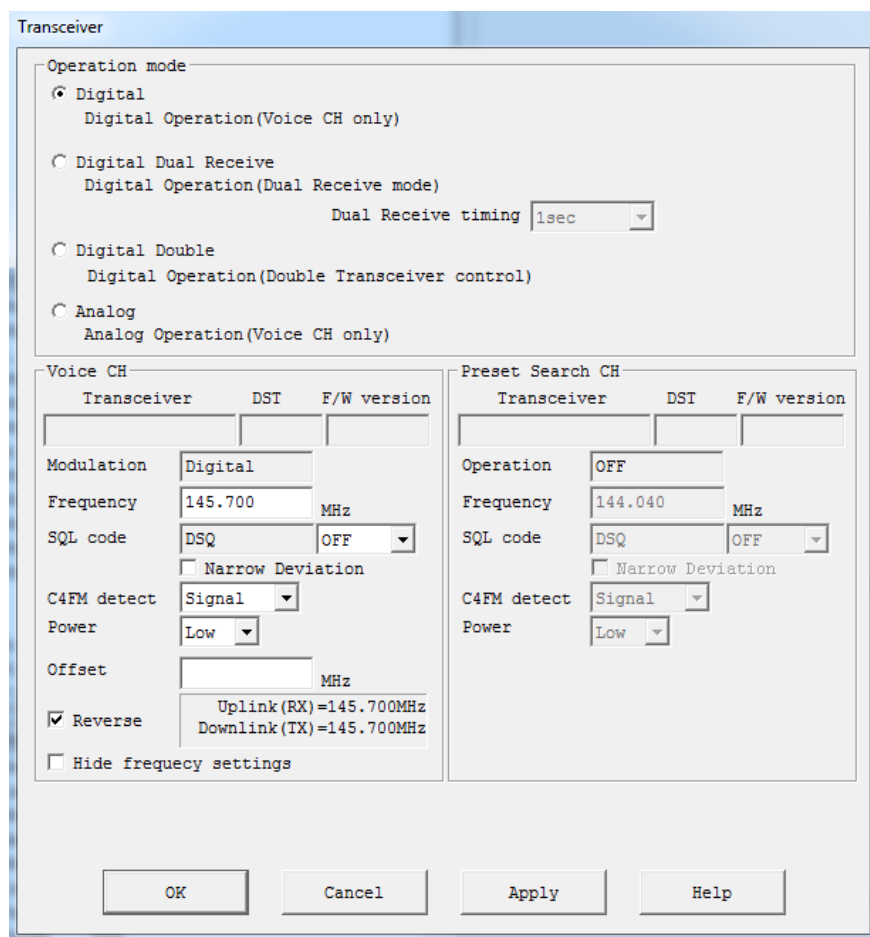

Figure 157 Default Transceiver settings

WIRES X – The Bible

2. Insert the DR1X repeater Frequency, e.g.;

The repeater's output frequency of 440.175 MHz with an offset of +5.000 MHz as shown...

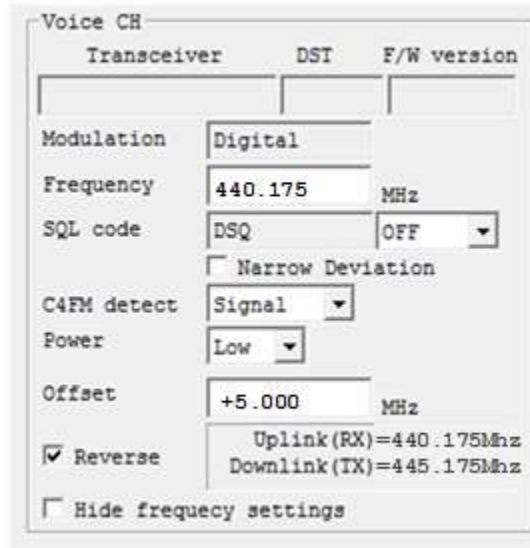

Figure 158 an example of a repeater setting

Note: if the repeater frequency is entered incorrectly....uncheck the reverse to set the frequency in reverse.

This sets the local node up to link to the repeater to emulate a conventional Amateur Radio Station connecting to a repeater. So the node connects the repeater to the WIRES X Network and any digital signal that is heard on the Network is relayed to the repeater. Any signal the repeater hears is relayed to the WIRES X Network.

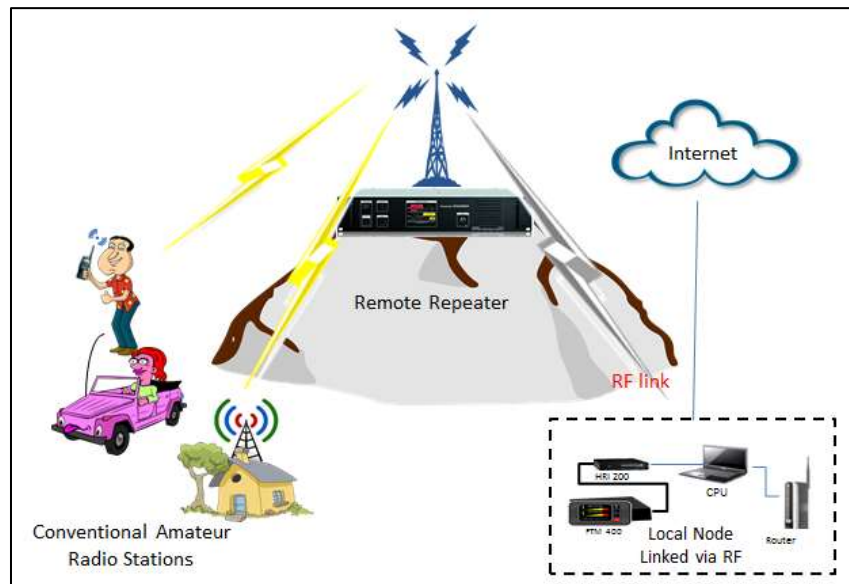

Figure 159 RF Linked Repeater

WIRES X – The Bible

WIRES X Repeater (Control Node Repeater)



Figure 160 WIRES X Repeater

An HRI-220 is connected to a DR1X/XE repeater it becomes a WIRES X Repeater (control node repeater); that is where a Yaesu DR1X repeater is used instead of a FTM 100 or FTM 400, as shown;

NOTE: When connecting an HRI-200 WIRES X Repeater, switch on the DR1X/XE unit while simultaneously pressing the mechanical "SETUP" button on the front panel. When the "YAESU" logo is displayed on the LCD touch screen, release the SETUP button, the LCD will change to "HRI-REPEATER MODE". Then press the "OK" button.

WIRES X – The Bible

The connection to between the DR1X/XE and the HRI 200 is shown as follows;

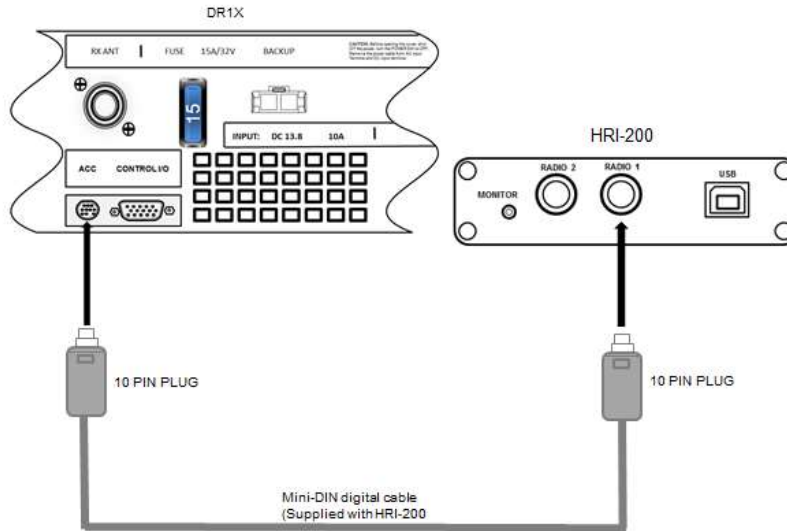

Figure 161 DR1X connected to HRI-200

When an HRI-200 is connected to a DR1X repeater, the following repeater setting screen for exclusive use of Repeater is displayed.



Figure 162 Transceiver Settings

When an HRI-200 WIRES X Repeater is detects a DR1X instead of a FTM 100 or a FTM 400, the setting information is read from the DR1X and is displayed on the screen shown in the preceding.

WIRES X – The Bible

The following is an explanation of the parameter shown..

[Voice CH] Panel

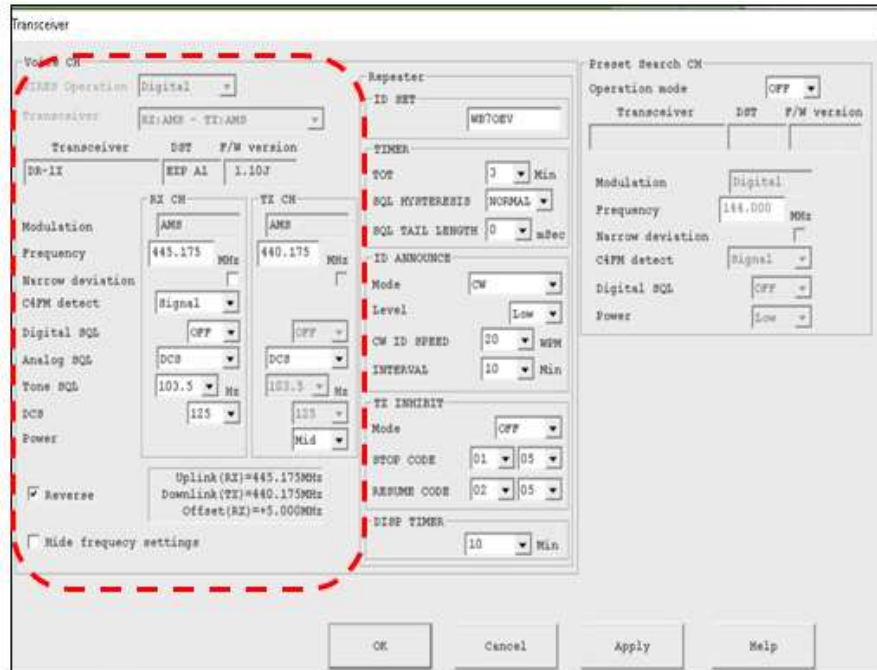

Figure 163 Voice Parameters

Voice CH uses WIRES-X to communicate via the Internet. Operation will be executed by controlling the repeater connected to the HRI-200 Radio 1 terminal.

The following parameters need to be set/display for operation.

[WIRES X Operation]

Select a WIRES operation mode from the following options:

1. **Digital:** C4FM digital mode.
2. **Analog:** FM Analog mode.

In our case, Digital is selected.

[NOTE]

WIRES X – The Bible

- a) The WIRES Operation is automatically set according to **TX CH parameters** (Transceiver) setting of the Repeater. However, if the transmit CH is AMS, the WIRES Operation setting must be selected. In this example the DR1X/XE has been set to AMS.
- b) When the Repeater is connected, you cannot operate the Digital Dual Receive mode.
- c) You cannot selected GM mode or connect to a closed room while in Analog (FM) operation.

[Transceiver]

Select the Repeater operation mode from the following:

1. **RX: FM - TX:FM** : FM Analog repeater (**WIRES Operation=Analog(fixed)**)
2. **RX: DIGITAL - TX:DIGITAL** : C4FM Digital repeater (**WIRES Operation=Digital(fixed)**)
3. **RX: AMS - TX:FM** : AMS to FM repeater (**WIRES Operation=Analog(fixed)**)
4. **RX: AMS - TX:DIGITAL** : AMS to C4FM repeater (**WIRES Operation=Analog(fixed)**)
5. **RX: AMS - TX: AMS**: AMS to AMS repeater (**WIRES Operation=selectable**). Our example shows this option selected.

[NOTE]

- A. When operating in RX: AMS mode, the WIRES-X system only relays the signal that is selected by the **WIRES Operation** setting.
- B. When "HRI-REPEATER MODE" is started in either the "RX: DIGITAL-TX: FM" or "RX: FM-TX: DIGITAL" state, the WIRES-X Node cannot operate.

[Transceiver / DST / F/W version]

This displays the data information of the digital transceiver in connection with the HRI-200. In the example shown above, this is show the firmware revision level of the DR1X/XE.

[Modulation]

Displays the Voice CH wave format selected for repeater operation.(RX CH and TX CH)

- **Digital**: Displayed if using digital (C4FM) mode.
- **Analog**: Displayed if using analog (FM) mode.
- **AMS**: Displayed if using AMS (Automatic Mode Select) mode *shown above*.

WIRES X – The Bible

[Frequency]

Enter the WIRES-X operating frequency (RX CH and TX CH) in MHz's

This is the DR1X Repeaters input and output frequency.

NOTE: This the coordinated repeater pairs assigned to the DR1X/XE repeater.

[Narrow deviation]

Select if using Narrow deviation operation.

[NOTE]

This parameter cannot be set different for the RX and TX channels.

This is left as default, uncheck.

[C4FM detect]

Select the C4FM squelch detection method for Digital operation.

Signal: RX becomes busy state when receiving any signal, *this selected as shown in the preceding.*

DSQ code: RX becomes busy state only when receiving a signal containing a matching DSQ code.

[Digital SQL/Analog SQL]

Enter the squelch code of the WIRES-X operating frequency (Voice CH frequency).

The entered data will be displayed on the ID list.

The following squelch codes are available:

(Analog Operation)

WIRES X – The Bible

No Tone: Not using CTCSS tone or DCS code squelch

ToneSQL: Using CTCSS tone squelch

DCS: Using DCS code squelch.

If using ToneSQL, select the desired tone frequency (67.0-254.1 Hz).

If using DCS, select the desired DCS code (023-754).

Shown in the display above, this is set to 125. This is a requirement by the Repeater Coordinating Body for my area.

(Digital Operation)

DSQ: Select the squelch code (OFF or 001-126) exclusive to digital mode.

[NOTE]

1. The SQL code parameter cannot be set different for the RX or TX channels.
2. The analog SQL type can be set individually for the RX and TX channels.
3. When making REMOTE settings in the TX INHIBIT function, there are some combinations that cannot be set.

(See the description of the [TX INHIBIT function](#) for details), as shown the display, it is select as **off**.

[Power]

Set the transmission power of the DR1X/XE repeater connected to the Radio 1 terminal, in this case the power is set to **Mid**.

[Reverse]

Set the Frequency offset information for the active ID list and Search signal response.



- **Reverse** (when checked): The offset frequency information equals **the uplink (RX CH) input frequency minus the downlink (TX CH) output frequency** (Default).

WIRES X – The Bible

(Example)

Uplink (RX CH) frequency = 445.175 MHz, Downlink (TX CH) frequency = 440.175, Reverse setting (Default)

* *Uplink (RX) = 445.175MHz / Downlink (TX) = 440.175MHz / Offset = +5.000MHz*

List output/search response info. = **440.175 MHz + 5.000 MHz**

- **Normal** (not checked): The offset frequency information equals **the downlink (TX CH) output frequency minus the uplink (RX CH) input frequency.**

(Example)

Uplink (RX CH) frequency = 445.175 MHz, Downlink (TX CH) frequency = 440.175MHz, Normal setting

* *Uplink (RX) = 445.175MHz / Downlink (TX) = 440.175MHz / Offset = -5.000MHz*

List output/search response info. = **440.175 MHz - 5.000 MHz**

[Hide frequency settings]

Hide transmission frequency data. If checked, operating data, such as frequency, can be temporarily hidden from the ID list.

WIRES X – The Bible

[Repeater] Panel

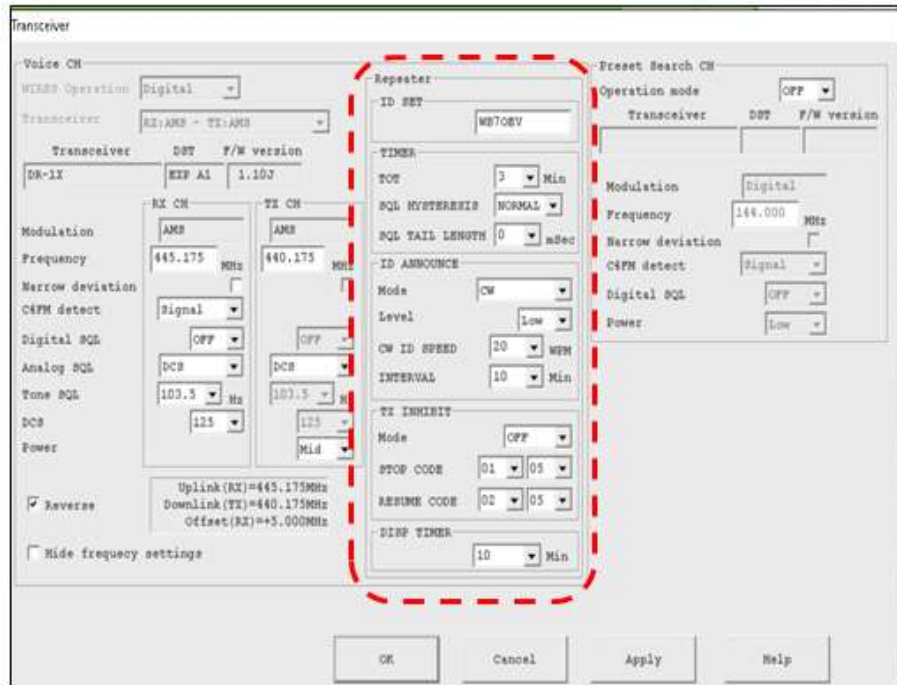

Figure 164 Repeater Panel

When connecting the HRI-200 and the DR-1X Repeater, the Repeater settings may be entered with a PC and the WIRES-X software.

[ID SET]

Set the ID (Repeater Callsign) information.(max 10byte)

[NOTE]

Please enter the same Callsign as the WIRES-X registration, as shown **WB7OEV**.

[TIMER]

Set the timer function

TOT (Timeout Timer): Set the Time-Out Timer to prevent continuous extended transmission.

SQL HYSTERESIS: Set the Hysteresis setting of the noise squelch circuit.

SQL TAIL LENGTH: Sets "squelch tail" duration for the transmission.

WIRES X – The Bible

[NOTE]

When the Termination signal is received; the transmission "squelch tail" is eliminated.
(Digital operation)

[ID ANNOUNCE]

Set the ID announcement.

Mode: Set the contents of the ID announcement

- * **CW:** CW ID
- * **CW wo TONE:** CW ID (TX without tone code)
- * **VOICE:** Voice ID (Voice guide unit(FVS-2) is required)
- * **VC wo TONE:** Voice ID (TX without tone code)(Voice guide unit (FVS-2) is required)

Level: Set the volume of the ID sound.

CW ID SPEED: Set the mark reproduction speed(wd/min) of the CW ID.

INTERVAL: Set the Transmission time interval between the ID announcements.

[Caution1 (CW ID SPEED)]

When operating in the USA the CW ID SPEED setting time must not exceed 20wd/min when keyed by an automatic device, to comply with the FCC rule Part 97: Sec.97.119 (b)(1)Station identification.

[Caution2 (INTERVAL)]

When operating in the USA the ID setting time should be ten minutes or less to comply with the FCC rule Part 97: Sec.97.119 (a) Station identification.

[TX INHIBIT]

Set transmit inhibit.

Mode: Set the TX INHIBIT function.

- * **OFF:** Permit repeater transmissions
- * **ON:** Restrict transmission
- * **REMOTE:** Remote transmits control by ECS (Enhanced Code Squelch) code.

WIRES X – The Bible

STOP/RESUME CODE: Set the ECS (Enhanced Code Squelch) code for remote TX control.

[NOTE]

The selected ECS code, must meet the following conditions:

- * Analog SQL is **151.4Hz or less (ToneSQL), or "DCS":** 01(67Hz) to 25(151.4Hz)
- * Analog SQL is **156.7Hz or higher (ToneSQL), or "No Tone" :** 26(156.7Hz) to 50(254.1Hz)

[DISP TIMER]

Set the repeater touch panel automatic light timer.

WIRES X – The Bible

[Preset Search CH] Panel -----

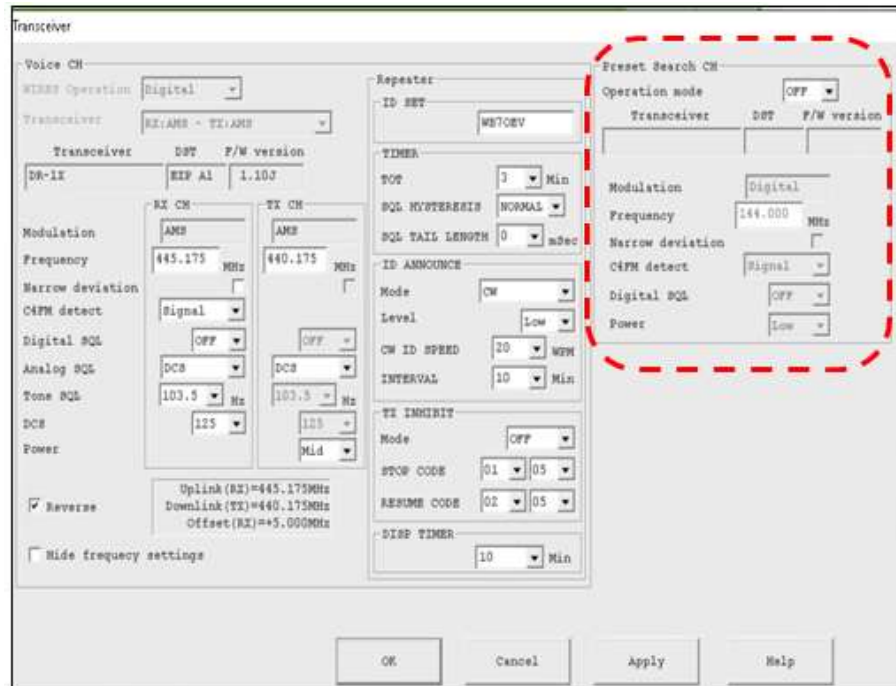

Figure 165 Preset Panel

In our example this is not being used we set this function **off**...the following explains a little about this.

WIRES-X compatible digital (C4FM) transceivers are able to transmit search signals to locate WIRES-X Node stations. There are 2 ways of transmitting this search signal.

(Manual Search Function)

Directly transmitting search signals via the WIRES Node station Voice CH

(Preset Search Function)

Establishing a unique search frequency at which the portable terminal transmits search signals

When WIRES Node stations detect search signals, it returns response signals on the CH at which it detected the original signal.

Response signals contain Voice CH operating data (frequency, SQL Code, offset data, etc.). Portable terminals use this information to adjust its setup to access the WIRES Node, entering WIRES-X access operation mode.

WIRES X – The Bible

Preset Search CH settings are for establishing this unique search frequency.

The following parameters need to be set for operation.

[Operation mode]

This displays the Preset Search CH operating mode.

* **OFF**: Displayed if not using Preset Search CH mode.

* **ON**: Displayed if using Preset Search CH mode.

[NOTE]

The search channel operation requires an HRI-200/**C4FM Digital** control mode capable transceiver (FTM-400D, FTM-100D etc.) connected to Radio 2 terminal of the HRI-200.

[Transceiver / DST / F/W version]

The firmware information of the digital transceiver connecting to HRI-200 for Preset CH operation is displayed.

[Modulation]

This displays the Preset search CH signal format.

[Frequency (Preset Search CH)]

Enter a unique WIRES-X Preset Search operating frequency in MHz

* Reference: In practice, consult with other WIRES-X stations to select a suitable frequency that will effectively avoid interference.

[Narrow deviation]

Select if using Narrow deviation operation for Preset CH transceiver.

WIRES X – The Bible

[C4FM detect]

Select the C4FM detection method for Preset CH operation.

Signal: Busy is indicated when receiving any signal.

DSQ code: Busy is indicated when receiving any signal containing the matching DSQ code.

[NOTE]

It should be noted that a transceiver with old version firmware cannot be changed from the PC.

Not supported versions:

- * FTM-400D/XD (ver2.20 and previous)
- * FTM-100D (ver1.20 and previous)

[Digital SQL]

Enter the squelch code setting for the WIRES-X Preset Search CH operating frequency.

The normal setting is DSQ=OFF. If using SQL Code, select from 001 to 126.

[Power (Preset Search CH)]

Set the transmission power of the WIRES-X Preset Search CH operating frequency.

This is a brief description on the Control Node Repeater, for more information see the HRI-200 Reference Manual for DR1/XE from www.yaesu.com for more information,

WIRES X – The Bible

Procedure to put the DR1X/XE into HRI-200 mode

1. If DR1X is on...turn power OFF.
2. While pressing and holding the [SETUP] button, Press the [POWER] switch, e.g.

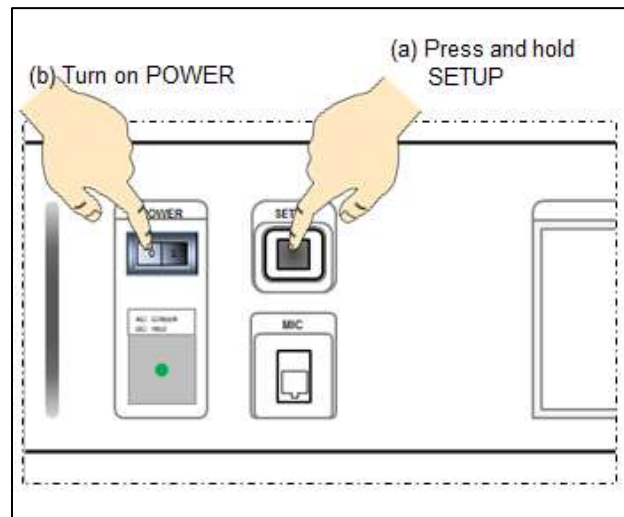

Figure 166 HRI 200 mode sequence

3. While the “YAESU” logo is being displayed, release the [SETUP] button. “HRI+REPEATER MODE” is displayed...as follows’

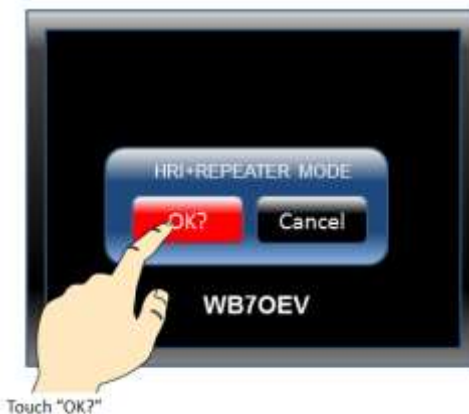

Figure 167 HRI Repeater Mode

4. Touch [OK?]. HRI mode activates...

WIRES X – The Bible

Return to Repeater mode from HRI mode, repeat the above step 1 thru 3 and ...

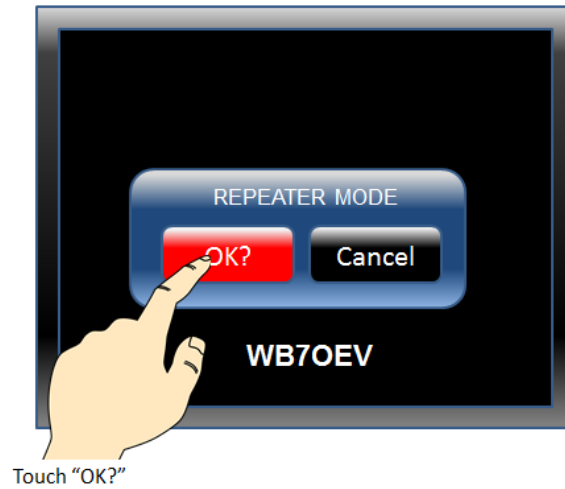

Figure 168 Back to Repeater Mode

And the DR1X/XE returns to Repeater mode (back to the Repeater mode).

WIRES X – The Bible

Static GPS entry for Fusion Radios

Yaesu Fusion Radio comes with built-in GPS Receivers. GPS is use for showing the position of the transceiver when transmitting a digital signal. When transmitting a digital signal in the DN mode the GPS position is transmitted to another digital radio and the receiving radio then uses the GPS information to compute the distant between the transmitter and the receiver and this is shown on the display of certain radios, such as the FTM 100, FTM 400 and the FT 991. The FT1(X)D and FT2D shows the distant on a secondary display.

Not all Yaesu Fusion Radios have built-in GPS Receiver and or the Fusion Radio is in an environment that does not allow the GPS receiver to receive a GPS signal. Example of this would be if the transceiver is located in a building and cannot see the GPS satellites. If this is the case and you want others to see the distant away from the transceiver, you need to enter a static (fixed) location for the transceiver.

The following show how to get a fixed GPS coordinate for your current location and how to convert the location to the format that can be enter into the transceiver.

1. Type in your address to google maps <https://www.google.com/maps/place> and hit enter. Look at the map, does this show your location? For Example;

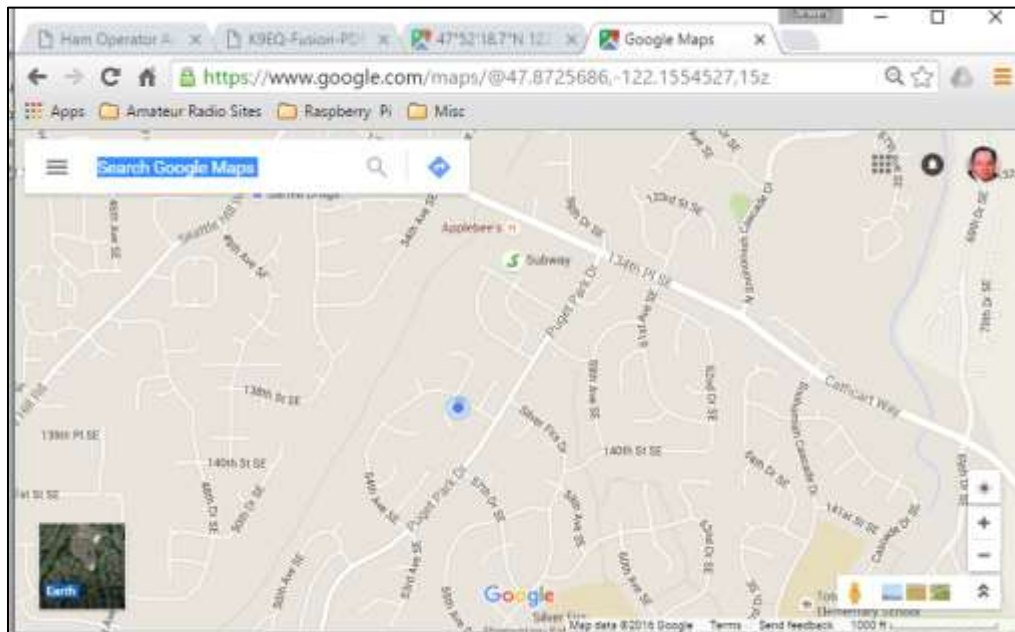

Note: the blue dot is my current location.

WIRES X – The Bible

2. If it does, right click the blue dot and a dialog box appears, and then clicks “what's here” as shown in the following;

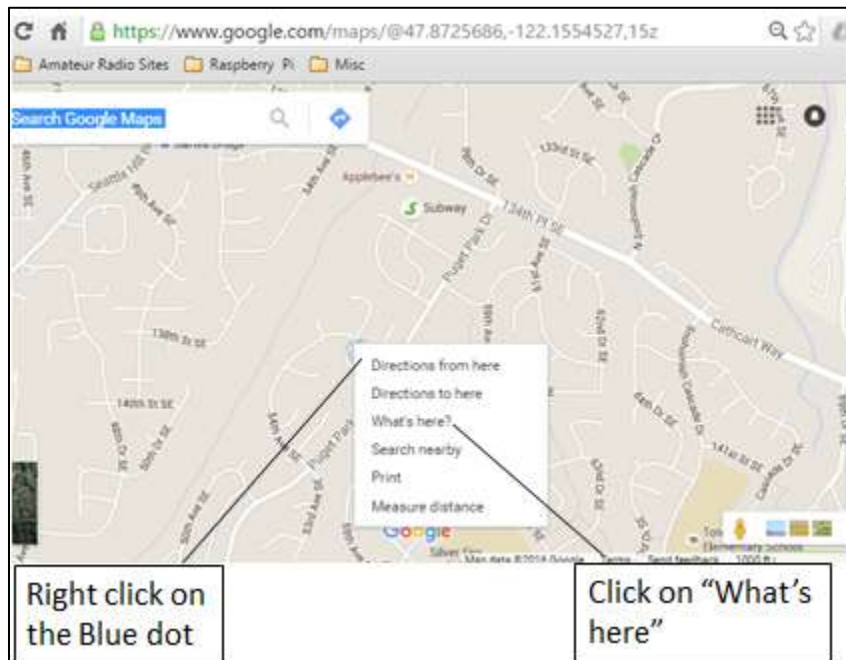

3. in the lower portion of the map window appears with the address at GPS location below the address something like “47.872007, -122.157599”, highlight the number and copy.

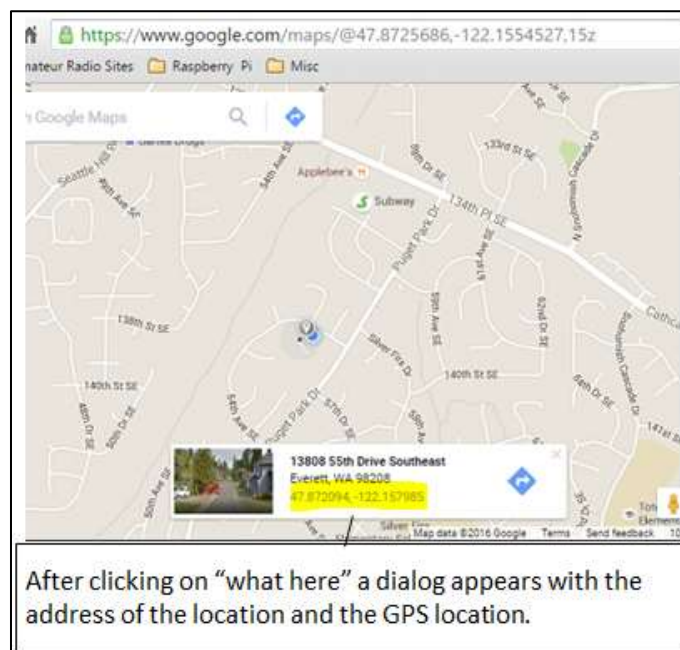

WIRES X – The Bible

- Go to <http://boulter.com/gps/> to convert the GPS coordinates to what the radio wants to use as per example below.

The screenshot shows the 'GPS Coordinate Converter, Maps and Info' website. It features an input field for coordinates with the example '47.872007, -122.157599' and a 'Convert and Map' button. Below the input are three output sections: 'Decimal Degrees (WGS84)', 'Degrees, Minutes & Seconds', and 'GPS'. The 'GPS' section is circled in blue and contains the coordinates 'N 47 52.320' and 'W 122 09.456'. To the right is a map with a red pin at the location. Three callout boxes provide instructions: '1. Paste the GPS location for your location to here.' points to the input field; '2. Click here to convert' points to the 'Convert and Map' button; and '3. Copy this GPS location Depending on the radio that you have.' points to the circled GPS coordinates.

- Paste the number form #2 above into the “enter coordinates” box.
- Click convert and map.
- Use the numbers from the GPS line. It should look like this;

Latitude Longitude

N 47 52.320 W 93 12.335

Now the GPS location is in a format that the Yaesu Radios can use. The following are procedure for each of the Fusion Radios that are available.

WIRES X – The Bible

Entering the Static GPS for the FT1(X)D

Manually enter the position information for your current location.

1. Press the  over a second.

This enters the Setting mode.

2. Now turn the  to select item [9 APRS].

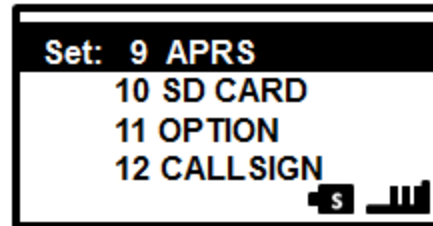

3. Press .

4. Turn  to select [24 MY POSITION].

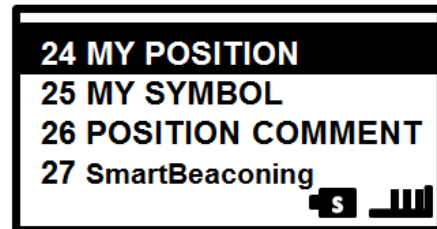

5. Press .

GPS setting items appears on the screen
Default: GPS

6. Turn the  to select [Lat].

7. Press .

The cursor moves the next item
for the Latitude.

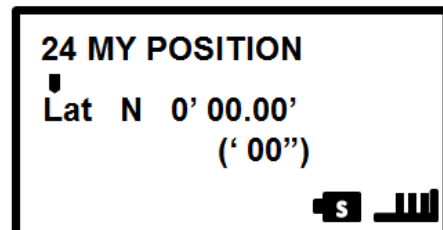

8. Again turn the  to set [N (north Latitude)] or [S (south latitude)].

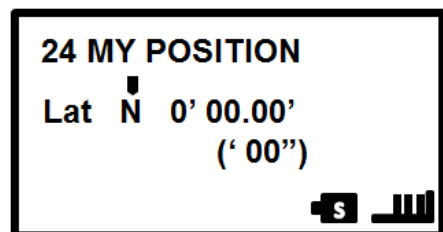

9. Press .

The cursor moves to the next item for
[Degree].

10. Turn  to set [Degree].

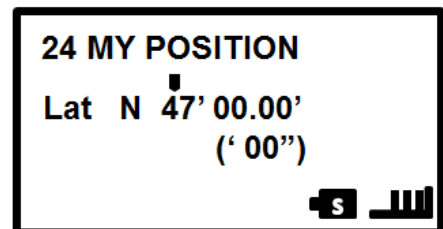

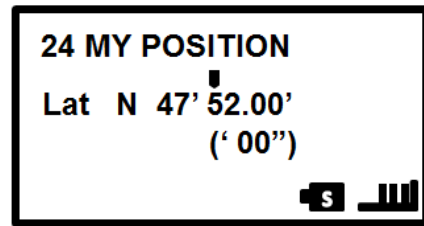

WIRES X – The Bible

11. Press , the cursor moves to the next item [Minute]



24 MY POSITION
Lat N 47' 52.00'
(' 00")

12. Turn  to enter [Minutes].

13. Press . The cursor move to the next item [1/100 Minutes].

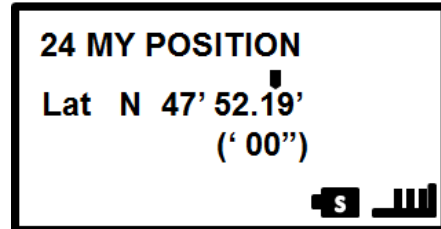

24 MY POSITION
Lat N 47' 52.19'
(' 00")

14. Turn the  to enter [1/100 Minutes]
Second will be displayed in parentheses.

15. Press , the cursor moves to Lat.

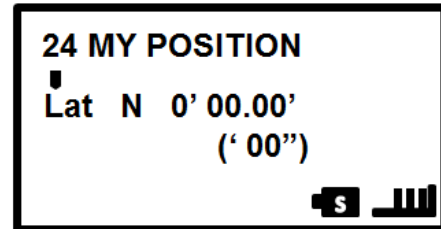

24 MY POSITION
Lat N 0' 00.00'
(' 00")

16. Turn  to select [Lon].

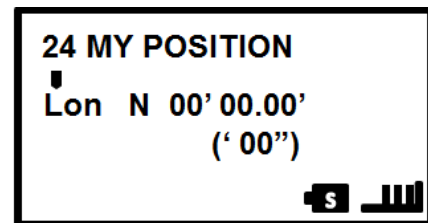

24 MY POSITION
Lon N 00' 00.00'
(' 00")

17. Press  and the cursor move to the next item for longitude.

18. Turn  to set [E (east longitude)] and [W (west longitude)].

19. Press , the cursor move to the next item [Degree].

20. Enter [Degree], [Minutes] and [1/100 Minute] repeating steps 9 through 13.

21. Press  ...the position information is Set.

WIRES X – The Bible

22. Press  to exit the Set Mode.

This completes the process for setting a static GPS position on the FT1(X)D radio, This is a brief description on manually setting the GPS. For additional information, see Yaesu.com for the FT1DR Instruction Manual (APRS Edition).

WIRES X – The Bible

Entering the Static GPS for the FT2D

Manually entering the position information of your FT2D

1. Press the  button for over a second.
The Set Mode Menu appears.





2. Touch [APRS].

3. Turn the  to select [24 MY POSITION] and touch it.

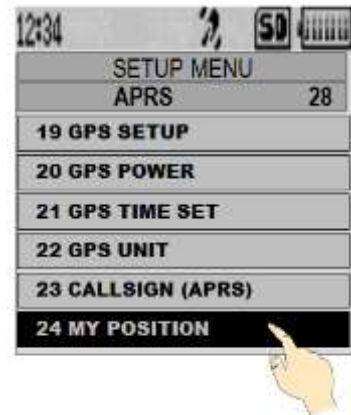
The screen for selecting method of the position information is displayed.



4. Turn the  to select [Manual] and press the  button. A screen to enter the position information of the FT2D appears.

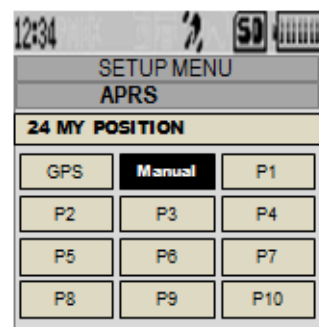

WIRES X – The Bible

5. Again turn the **DIAL** to select “LAT” and Press the **DISP** button. The cursor moves to the item for setting the Latitude.

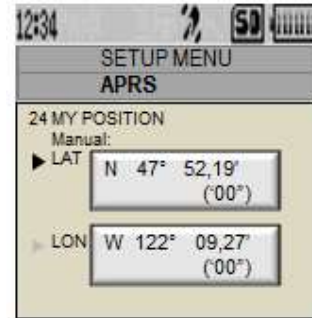

6. Turn the **DIAL** to select “N (north latitude)” or “S (south latitude)” then press **DISP** button to move the cursor to the item for setting the “degree”.

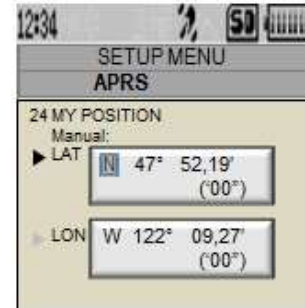

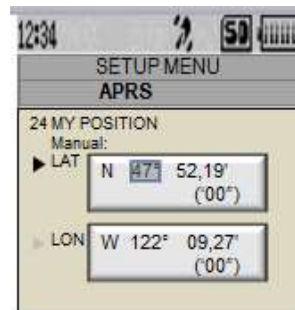

7. Turn the **DIAL** to select [Degree], and then press the **DISP** button. The cursor then moves to the item for setting the “Minutes”.



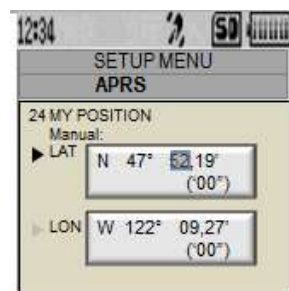

8. Turn the **DIAL** to select [Minute] and press the **DISP** button. The cursor then moves to the item for setting the “1/100th Minute”.



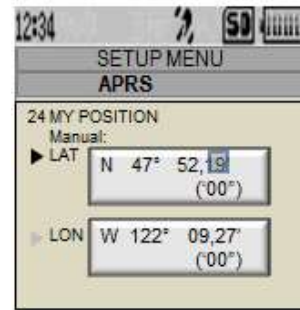

WIRES X – The Bible

9. Turn the  to select [1/100th Minute] and press the  button. The seconds is displayed within the parentheses.

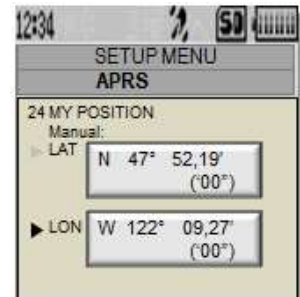

10. Turn the  to select [LON] and press the  button and the cursor move to the setting for the longitude.



11. Turn the  to select “E (east longitude)” or “W (west longitude)’ and press the  button and the cursor then moves for setting for “degree”.
12. Enter “degree”, “minute” and “1/100th minute” in the same way as in step 7 through 9.
13. Press the DISP button and the position information is set for the FT2D.

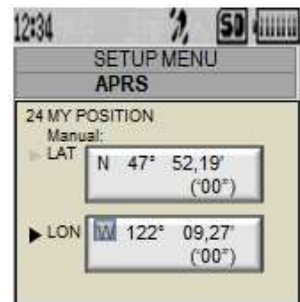

14. Press the  to exit the set mode and return to the main screen.

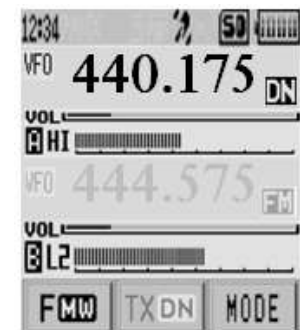

This completes the process for setting a static GPS position on the FT2D radio. This is a brief description on manually setting the GPS. For more information, see Yaesu.com for the FT2D Instruction Manual (APRS Edition).



WIRES X – The Bible

Entering the Static GPS for the FTM 100DR



On the FTM-100DR the latitude and longitude can be entered by the following procedure, when not using the GPS Function. This may be necessary when the GPS satellites are not accessible or the FTM 100 is use in a fixed location,

1. Press  for a second or longer. The set-up menu is displayed.



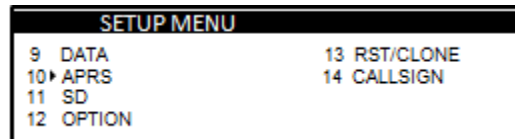

2. Turn the , select [10 APRS], then press  and the menu list is displayed.



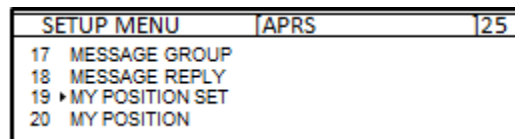

3. Turn the , select [19 MY POSITION SET], then press  and the screen selecting the method of the position information appears.

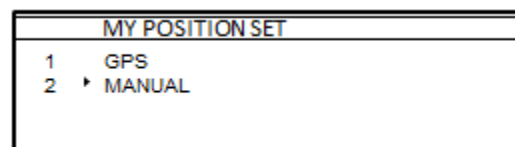

4. Turn the , select [2 MANUAL].
5. Press . "2 MANUAL" is selected and the display returns to the menu list.



6. Turn the , select [20 MY POSITION] then press  and the screen setting for the FT2D information is displayed.

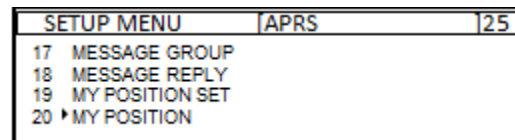

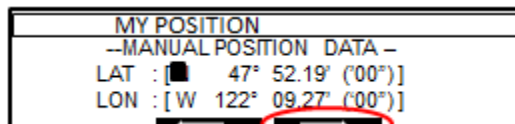

7. Press . The cursor shift to the latitude position.



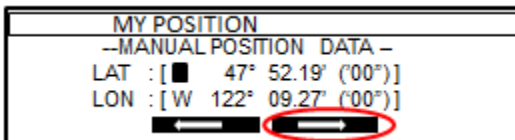

8. Turn the , select north latitude (N) or





WIRES X – The Bible

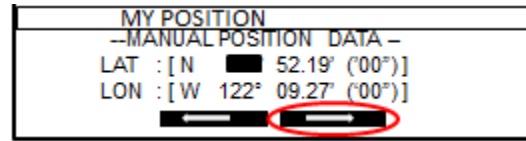

south latitude (S) then press   .
The cursor shifts to the “degree” setting.

9. Turn the  to input the degrees, then press   , and the cursor shifts to minutes settings.



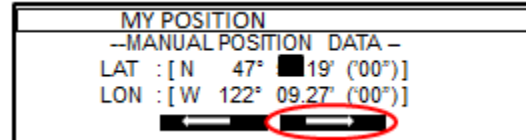

10. Turn the  , input the minutes then press   , then the cursor shifts to the “1/100 minutes” settings.



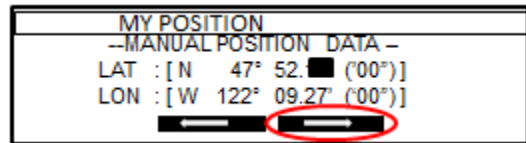

11. Turn the  , input the 1/100 minutes then press   , then the cursor shifts to the longitude settings.

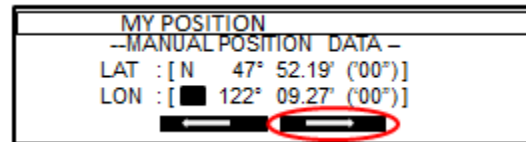

12. Turn the  , input the longitude (E) or west longitude (W), then press   , then the cursor shifts to the “degrees” settings.



13. Repeat steps 9 through 11; input the degrees, minutes and 1/100 minutes.
14. Press  , the latitude and longitude is set.

15. Press  for over a second to display the previous screen.

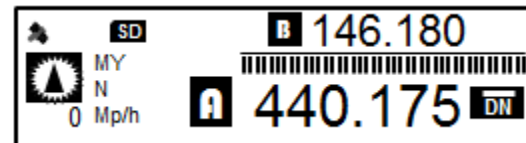

This completes the process for setting a static GPS position on the FTM-100DR radio. This is a brief description on manually setting the GPS. For more information, see Yaesu.com for the FTM-100DR Instruction Manual (APRS Edition).

WIRES X – The Bible

Entering the Static GPS for the FTM 400DR

The latitude and longitude on the FTM 400 is entered by following the procedure, when not using the GPS function. This is necessary when the FTM 400 cannot access the GPS Satellites or when it is in a fixed location.

1. Press  button for over a second, and the setup menu appears.

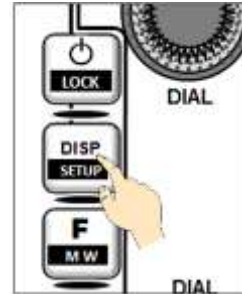

2. Select and touch **[APRS]**, the menu list is displayed.

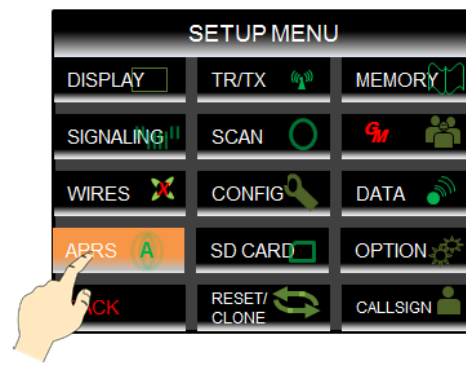

3. Touch **[26 MY POSITION SET]** and the screen to choose the how to select the GPS method.

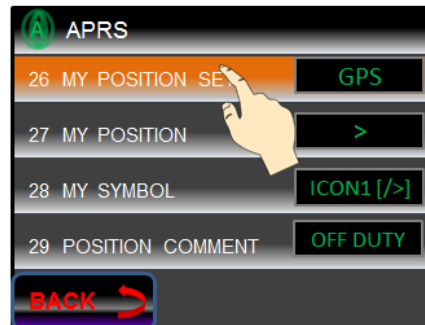

4. Touch **[MANUAL]**, this is selected and the screen change to selection list.



WIRES X – The Bible

5. Select **[27 MY POSITION]** and the display changes to selecting the latitude and longitude to be entered.



6. Touch **[LAT]**, the screen for entering the latitude appears.

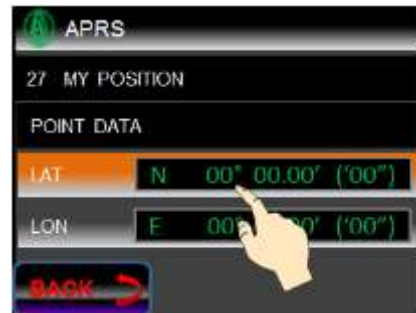

7. Touch **[N]** or **[S]**; Select either the northern latitude or the southern latitude. The cursor will shift to the right and only the number keys can be pressed.



8. Press the number keys to enter the “degrees”, “minutes” and “1/100 minute”. The cursor shifts to the right each time a number entered.



9. Touch **[ENT]**, the display returns to original display and set latitude is displayed in **[LAT]**.

WIRES X – The Bible

10. Touch [**LON**] twice, the display for entering the longitude is shown.

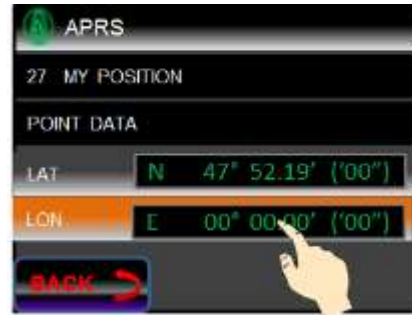

11. Touch [**E**] or [**W**], to select the eastern longitude or the western longitude.

The cursor shifts to the right and when the number key is pressed.

12. Enter the “degrees”, “minutes” and “1/100 minutes” in as shown in step 6.

13. Touch [**ENT**] and the display returns to previous screen. The set longitude is displayed in the [**LON**].

14. Press  for over second and the Static GPS information is registered and the display returns to the previous screen.

This completes the process for setting a static GPS position on the FTM-400DR radio. This is a brief description on manually setting the GPS. For more information, see Yaesu.com for the FTM-400DR Instruction Manual (APRS Edition).

WIRES X – The Bible

Entering the Static GPS for the FT 991DR

On the FT 991 the latitude and longitude can be entered by the following procedure. This is necessary; the FT 991 does not have a built-in GPS Receiver.

1. Press and hold the  button and the following appears;

Touch the [LAT/LON] on the Screen to enter the latitude or longitude for the FT 991.

2. Now touch [LAT] as shown below.

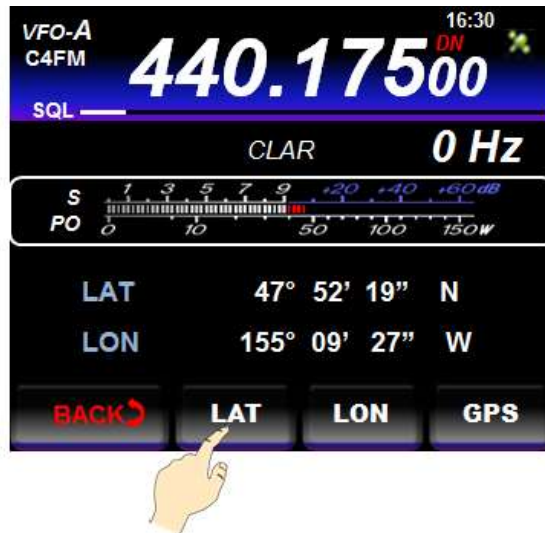

3. Enter the latitude using the display's keypad then touch [ENT] followed by touching the [BACK] button.

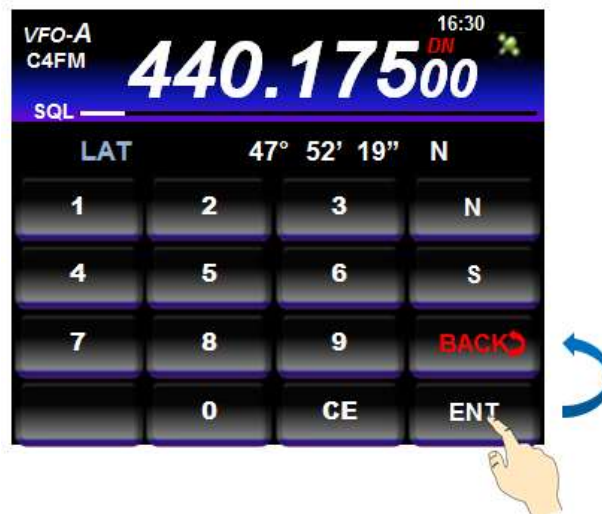

4. After touching the [BACK] button, the previous screen is redisplayed...

WIRES X – The Bible

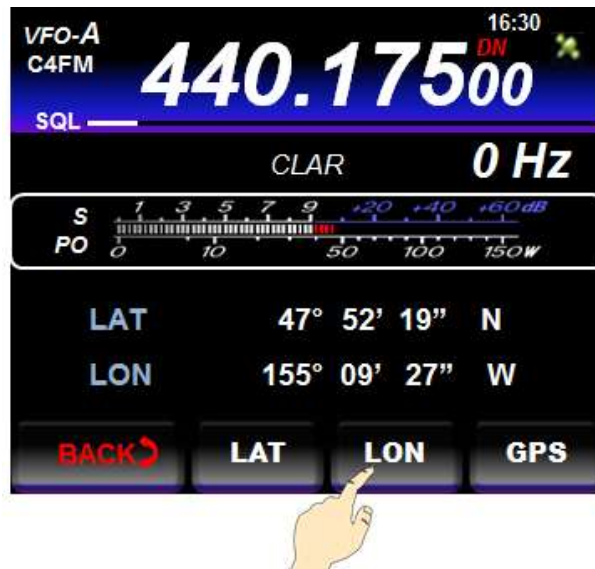

Touch the [LON] button to enter the longitude.

5. After pressing the [LON] button the display changes to the longitude entry key pad.

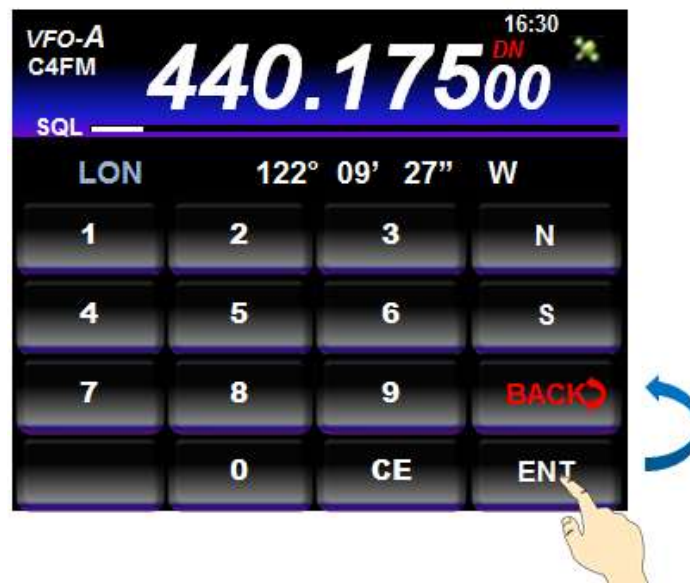

Enter the longitude using the numeric key pad then touch [ENT] followed by [BACK] to register the longitude, and the previous screen is displayed.

WIRES X – The Bible



The updated latitude and longitude are displayed.

6. Press the  button to exit to the previous display.

Note: The manually registered latitude and longitude can be erased by touching and holding the [LAT]/[LON] on the screen for one second.

This completes the process for setting a static GPS position on the FT 991 radio. This is a brief description on manually setting the GPS. For more information, see Yaesu.com for the FT 991 Operating Manual, page 113,