

# The HAMMARLUND COMET "PRO"

H I G H F R E Q U E N C Y  
S U P E R H E T E R O D Y N E S

SIXTH EDITION

STANDARD AND CRYSTAL MODELS

AN OUTSTANDING GROUP OF RECEIVERS FOR PROFESSIONAL AND  
AMATEUR USES

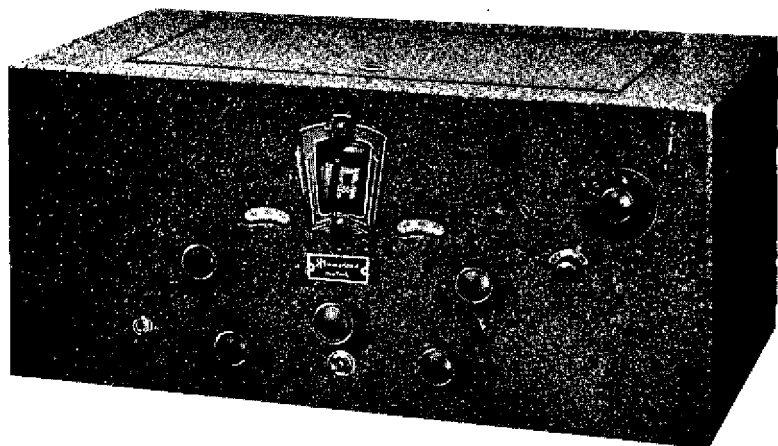

*Crystal Model*

COMET "Pros" are high frequency superheterodynes designed to meet the exacting demands of professional operators and advanced amateurs interested in the reception of both code and voice radio signals in the frequency range from 20,000 K.C. to 1,200 K.C. In addition, they are suitable for various kinds of experimental and research work involving frequencies in that range where high sensitivity, low noise level, and great selectivity are important.

Before taking up the actual description of the receiver it may be interesting to go over some of the more important considerations involved in short wave receiver design. First of all comes the question of power supply; shall it be

batteries or alternating current. Of course this controversy is automatically answered in situations where no alternating current is available, but these relatively few cases were disregarded and complete A.C. operation decided upon. There is really no comparison from the standpoint of convenience; in fact the only argument in favor of battery operation seemed to be from the standpoint of quietness of operation which is unquestionably of paramount importance in the reception of extremely weak signals. After some experimental work even this argument was disproved, as it was found perfectly possible to build an all A.C. receiver just as quiet in operation as the finest battery-operated receivers.

Next come selectivity and sensitivity, which while separate and distinct qualities in themselves, are nevertheless dependent on each other in most practical receiver designs. The superheterodyne, or double detection type of receiver, undoubtedly offers outstanding advantages in the matter of selectivity and sensitivity, especially where such a wide range of signal frequencies must be covered. Then once again the question of noise was raised—all superheterodynes were considered too noisy for satisfactory weak signal reception. But experimental work also disproved this theory and so work was started in earnest on an A.C. operated superheterodyne. An intermediate frequency of 465 K.C. was chosen as a compromise. It is below the broadcast band, and at the same time is high enough to provide a large spread between a desired signal and its "image" interference. By using Litz wound intermediate coils the selectivity and sensitivity are kept high. This and many other design features are described in more detail in the following paragraphs.

### *Description of Standard Models*

The following description covers the standard "Pro" receiver. Crystal and AVC models employ the same fundamental circuit and general features. The essential difference of these models are completely covered in special sections of this booklet.

Interchangeable plug-in coils are used to shift from one frequency range to another. Two coils, one OSC and one W.L., constitute a set, and the tuning condensers are of such size that each set of coils covers a frequency range of approximately two to one. To provide ample overlap four sets of coils are used to cover the range from 15 to 250 meters. The coils are wound on extruded Isolantite forms  $1\frac{1}{2}$ " in diameter. This results in high electrical efficiency and also great mechanical stability, which aids materially in maintaining dial calibrations. The coils plug into special extruded Isolantite sockets with double grip clips which make contact to opposite sides of each coil prong, insuring reliable electrical connection with consequent freedom from noise due to variations in contact resistance. Any variation in resistance at these coil terminals would modulate the incoming signal carrier. Since these coil terminals are really the input to the receiver, any modulation at this point would be amplified by all succeeding stages resulting in serious noise in the output circuit.

For this reason all switches or other sources of variable contact resistance have been avoided in the design of this receiver. Both OSC and W.L. coils are completely shielded in separate shield cans. The covers of these shields are readily removable to facilitate changing from one frequency range to another. The use of these coil shields eliminates all electro-magnetic coupling between OSC and W.L. coils as well as direct pickup from stray fields of any kind.

### Band Spread Feature

The arrangement of the tuning condensers is interesting and unique. The fundamental circuit is shown in Fig. 1, and although designed primarily to give a band-spreading action on the four amateur bands of 20, 40, 80, and 160 meters, the same effect is obtainable throughout the entire range from 15-250 meters, (20,000 to 1,200 K.C.) Condensers A and B, of 138 mmf. each, constitute tank condensers and are individually controlled by separate vernier dials, one at left center and one at right center of the panel. By means of these two condensers, together with the appropriate set of coils, the receiver may be tuned to any frequency within its range. After this has been done, the main tuning dial, which controls condensers C, D, E, and F, will provide substantially true single control over a relatively narrow band of frequencies. If the main dial is set at 50 when the adjustment of the two tank condensers is made, approximately half of the spread band will be above and the other half below the mean frequency determined by the choice of coils and the setting of the two tank condensers. If the main dial is at zero when the tank condensers are adjusted the entire spread band will be above that frequency. Conversely, setting the band with the main dial at 100 will throw the spread band on the lower frequency side. The dials on the two tank condensers are finely and accurately calibrated to facilitate precise logging. While calibration curves are furnished with each receiver, the operator should make an accurate calibration of his own receiver by means of standard frequency signals, certain stations known to be well controlled, etc. Very precise duplication of band settings can be made by logging a few "key" stations in or near a desired frequency band. The stations chosen as "key" stations should be of known frequency stability, and moreover should operate on fairly continuous schedules. Suppose, for example, station XYZ meets the above requirements and is selected as a "key" station for the 14 mega-cycle amateur band extending from 14 to 14.4 mega-cycles. After setting the tank condensers (with main dial at 50) as near as possible to 14.2 mega-cycles, let us assume that station XYZ is found at 7 on the main dial. The settings of both tank condensers and main dial for

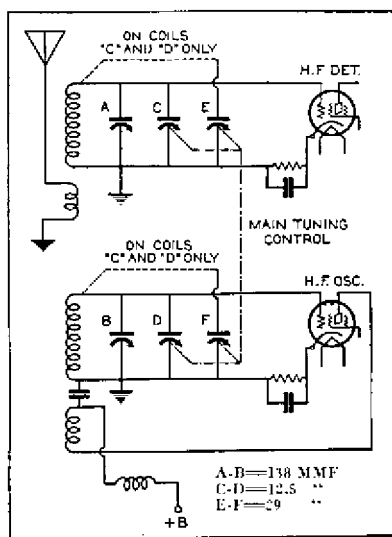
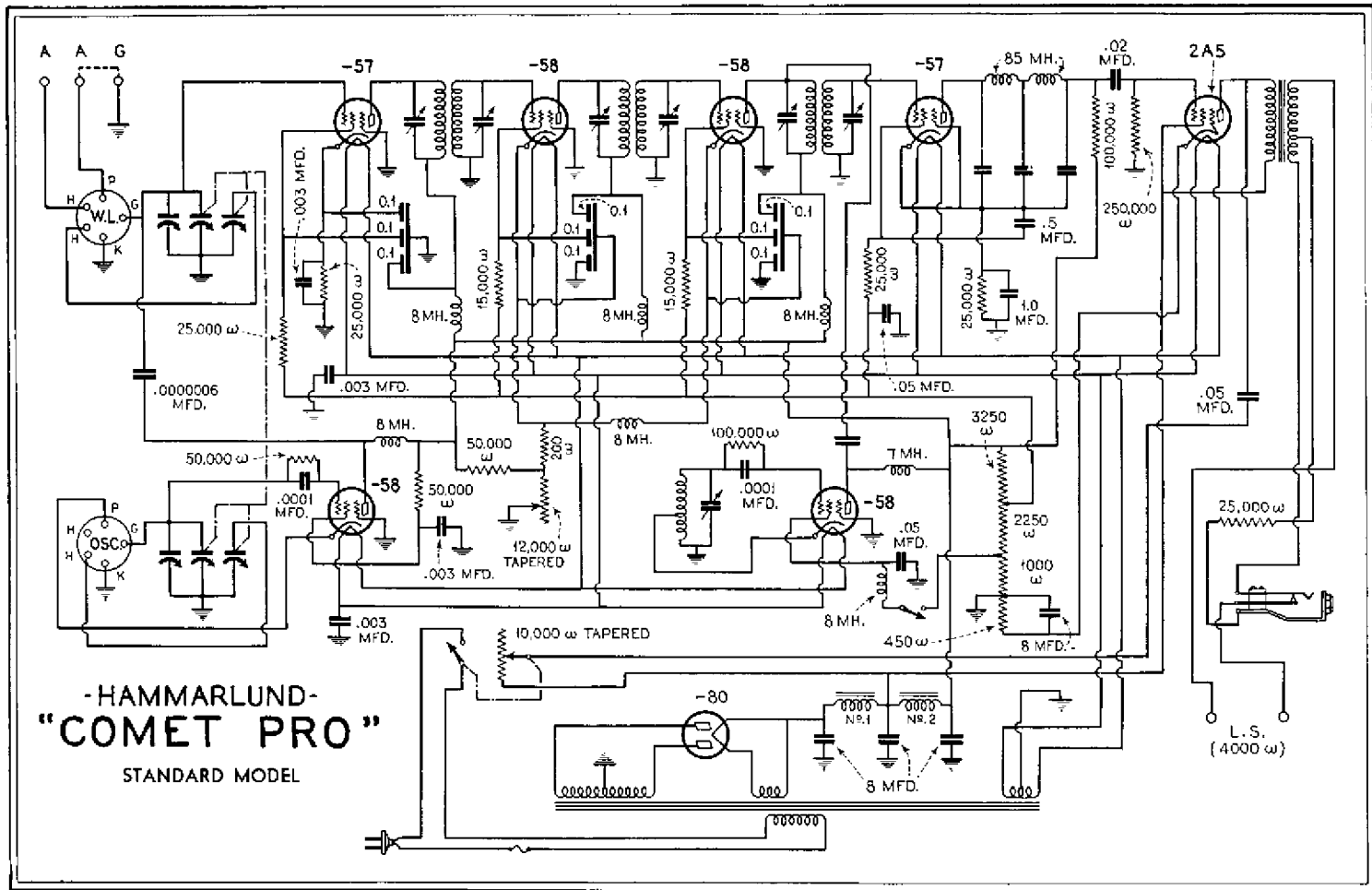

Fig. 1



station XYZ should now be recorded. To reset the receiver at any subsequent time to *exactly* that same band, the tank condensers should be set as logged and the main dial set at 7. If station XYZ is heard (which is not very probable) all well and good. If not, a slight readjustment of the *tank* condensers will bring it in if it is on the air, after which the band setting of the receiver will be exactly the same as on the previous occasion when the original logging of station XYZ was made.

This type of band spreading circuit necessarily results in a non-uniform band width at various frequencies, and this fact should be taken into consideration by the operator. At 20 mega-cycles the band is approximately 1,500 K.C.

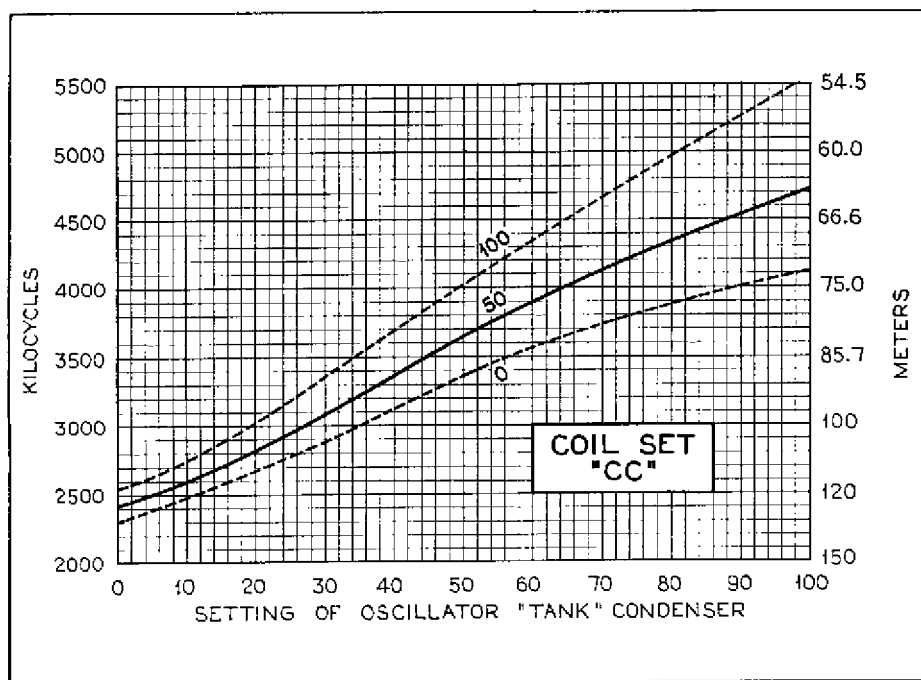
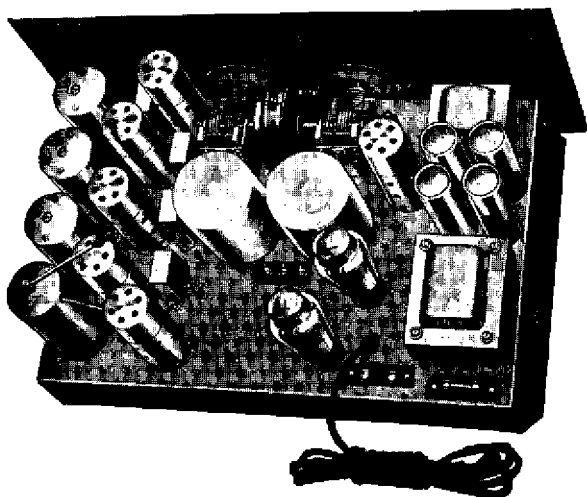

Fig. 2

wide and narrows to 300 K.C. wide at 10 mega-cycles (using the "AA" coils). With the "BB" coils the band width is 1,000 K.C. at 10 mc. and 150 K.C. wide at 5 mc. The band spreading on these two ranges is accomplished by the 12.5 mmf. condensers C and D, Fig. 1, on the main tuning dial. These condensers alone are inadequate for proper band width in the 5 mc. to 1.5 mc. range covered by the "CC" and "DD" coils. In this range, the 29 mmf. condensers E and F (Fig. 1) are connected into the circuit also. However, no switch is necessary, as this additional connection is automatically made when the "CC" and "DD" coils are inserted in their sockets. The fifth coil prong (which is not used in Coils "AA" and "BB") is used for this purpose in Coils "CC" and "DD." In this frequency range the band width varies from approximately 1,200 K.C. at 4.5 mc. to 225 K.C. at 1.5 mc.

Figure 2 shows the tuning characteristics of the "CC" coils. To simplify this chart, only the oscillator tank condenser is shown. The solid line is the calibration of the oscillator condenser with the band spread dial set at 50. The vertical difference between the two dotted line curves indicates the frequency range covered by the band spread dial for any particular oscillator setting. A complete set of tuning charts are furnished with



*Standard Model*

each set to cover the ranges of the standard coils supplied with the receiver, viz: 15 to 31 meters; 28 to 61 meters; 56 to 120 meters, and 115 to 250 meters.

Special coils are available to cover the 8 to 16 meter range and 250 to 550 meter range.

A further advantage of the "tank" system of tuning used in the Comet "Pro" lies in its ability to overcome "image" interference which may be encountered under certain conditions. As is well known there are two settings of the heterodyne oscillator of a superheterodyne receiver which will beat with the incoming signal to produce the desired intermediate frequency, which in this case is 465 K.C. One of these is the signal frequency plus the I.F., the other is signal frequency minus I.F. In the Comet "Pro" the design of the tuned circuits is based on the use of the higher of these two oscillator settings, that is, signal frequency plus intermediate frequency. Image interference encountered at this setting may be avoided by reducing the heterodyne oscillator frequency by an amount equal to twice the intermediate frequency or 930 K.C. This is accomplished by reducing the dial reading of the left hand "tank" condenser which controls the heterodyne oscillator tuning. The right hand or W.L. dial should not be changed.

#### *Electronic Coupled Oscillator*

As will be noticed by inspection of the circuit diagram of the receiver the high-frequency or heterodyne oscillator is of the "electronic coupled" type. The many advantages of this type of oscillator for superheterodynes are too well known to enumerate here. A "58" tube is used with its suppressor grid grounded directly to the chassis, thus more completely isolating its plate from the oscillatory circuit. A small condenser of about 0.6 mmf. connected to the plate of the oscillator couples a small amount of its output directly to the grid of the first detector. This type of coupling, together with the shielding of the

OSC and W.L. coils effectively eliminates all interaction between these two circuits, even at frequencies as high as 20 mc.

### Screen Grid Pentodes as Detectors and I.F. Amplifiers

The first detector is a "57" screen grid pentode. Its high detector sensitivity and high output impedance make it highly suitable to work into the high impedance primary of the first I.F. transformer. A further reason for its choice lies in its high input impedance and low effective input capacity, which together reduce the damping on the tuned input (W.L.) circuit at the same time permitting a larger frequency range to be covered with a given coil and condenser.

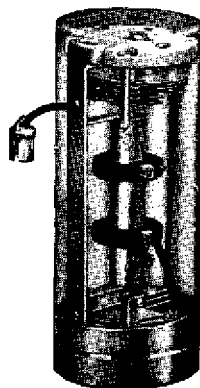
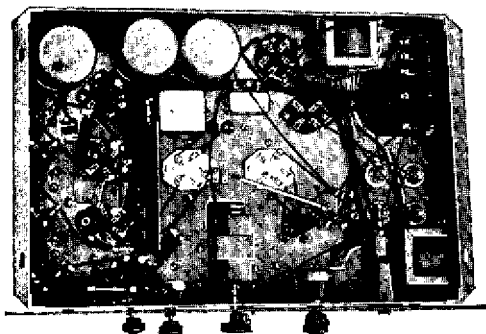

Fig. 3

The two intermediate amplifying stages employ "58" variable-mu pentodes, and the intermediate coupling transformers are of the twin-coil tuned plate, tuned grid type. Since the intermediate amplifier provides most of the receiver's sensitivity and selectivity, no effort has been spared in the design and construction of the intermediate transformers. The transformer coils are wound with 10/41 Litz wire and have an inductance of 1.3 millihenries. At 465 K.C., these coils have a power factor of .0087 or a Q of 115.

In order to preserve this high efficiency the coils are accurately centered in the transformer shields and kept well away from the mounting brackets. The coefficient of coupling between primary and secondary is 0.77%. While this degree of coupling is slightly under the optimum value for two such high "Q" circuits and results in a single sharp peaked response curve with steeply sloping sides, it is sufficient to afford a voltage gain of approximately 200 per stage. Among the outstanding features of these transformers, illustrated in Fig. 3, are the condensers used for tuning the primary and secondary coils to the intermediate frequency. They are air-dielectric variable condensers of unique design and were developed by this company specifically for this purpose. The capacity and power factor of these condensers remain substantially constant regardless of varying atmospheric conditions, and their mechanical construction is such that they are not affected by vibration or shock. The use of these air-dielectric tuning condensers completely solves the problem of accurately maintaining the high degree of intermediate amplifier selectivity and sensitivity so necessary to high-grade superheterodyne performance. To illustrate this point Fig. 4 shows the effect of the humidity and vibration on a transformer tuned by condensers of the



Bottom View—Standard Model

mica-compression type. Fig. 5 shows the results of the same tests on one of the new air-tuned transformers. The superiority of the latter is at once evident, and when it is realized that three transformers are generally used in a receiver, it is easy to understand why the gain and selectivity of some superheterodynes change so erratically with varying atmospheric conditions.

The second, or I.F. detector, is also a "57" screen grid pentode operated as a plate rectifier. Since its plate circuit contains a large I.F. component in addition to the desired audio frequencies a filter is necessary to remove it, otherwise undesirable feed back would result. This feed back can be very troublesome in a superheterodyne. In view of the fact that the tube is working as a rectifier, its plate circuit contains not only the fundamental intermediate frequency but also strong harmonic frequencies, especially the even ones. If not thoroughly suppressed these harmonics would induce voltages in the input circuit which would seriously hamper reception of signal frequencies at, or near

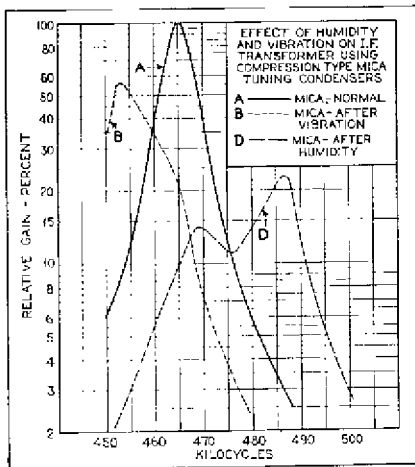

Fig. 4

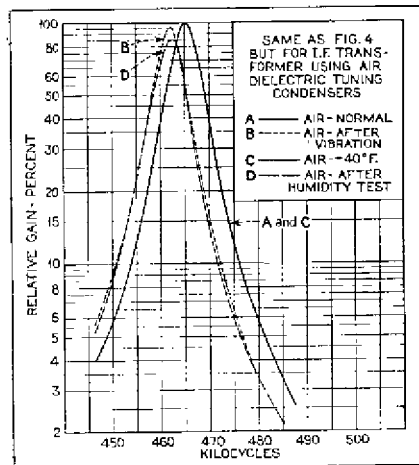

Fig. 5

multiples of the intermediate frequency. In the Comet "Pro," this feed back has been minimized by exceptionally thorough filtering and shielding. A two stage filter consisting of three .00025 mfd. by-pass condensers and two 85 millihenry chokes is used. In addition each stage of this filter is completely enclosed in a separate shield compartment.

#### High-Power Humless Output and Smooth Control of Sensitivity

The output tube is a "2A5," resistance-capacity coupled to the second or intermediate frequency detector. The high amplification and great power handling capabilities of this type tube insure good loud speaker volume even on very weak distant signals. An output transformer is mounted underneath the chassis with its secondary connected to the speaker terminal block at the rear edge of the chassis, and is designed to operate any speaker, either magnetic or dynamic (or permanent magnet dynamic), having an input impedance of the order of

4,000 ohms. A tap on the secondary of the output transformer is connected through a resistor to the jack on the front panel, thus providing head-phone reception at reduced volume and with a minimum of hum. Due to the use of a built-in output transformer there is no direct current component at either the loud speaker terminals or the phone-jack. The jack is wired so that insertion of the phone plug breaks the circuit to the speaker terminals, which can therefore be permanently connected to the loud speaker.

The volume control, or more properly, the gain or sensitivity control, consists of a variable biasing resistor in the cathode circuits of the two "58" intermediate amplifier tubes. In order to obtain wide control without using an excessively high variable resistance, a steady current of approximately five milliamperes flows through this bias control in addition to the plate and screen currents of the two tubes. This additional current has but little effect at low bias voltages where the tube current is high, but its effects increases rapidly as the tube current falls off at the higher bias voltages. The combination provides smooth as well as wide control of the overall sensitivity of the receiver.

### *C.W. Reception*

A very important feature of the Comet "Pro" is the intermediate oscillator, which can be started and stopped by the toggle switch on the panel. It consists of a "58" tube and associated circuits permanently adjusted to oscillate at the intermediate frequency of 465 K.C. Like the high-frequency oscillator, it is also of the "electronic coupled" type. This results in great stability of oscillation and entirely eliminates the "pulling into step" effect when receiving strong C.W. signals. A small portion of its output is fed to the grid of the second or intermediate detector, thus producing an audible beat note with the incoming signal. The tuned circuit of this beat oscillator is completely shielded in the vertical shield in the rear right-hand corner of the chassis. The circuit is tuned by means of an air-dielectric condenser similar to those used in the I.F. transformers but of greater capacity. This condenser is mounted in the bottom of the shield and is adjustable from underneath the chassis. In addition a three plate vernier condenser is mounted in the top of the shield and connected in parallel with the main condenser. This vernier condenser is adjustable by means of the lever protruding from the top of the oscillator shield. The normal setting of this lever for zero beat reception is the diagonal or  $45^\circ$  position. By moving lever through  $90^\circ$  angle (plus or minus  $45^\circ$ ) the beat frequency may be changed approximately 8,000 cycles. When this vernier lever is properly adjusted a considerable degree of "single signal" C.W. selectivity is possible. Using a 2,000 cycle beat note the measured attenuation of the "audio image" was found to be 25 D.B. As in the case of the I.F. transformers, the use of air condenser tuning in this oscillator circuit results in such a high order of frequency stability that readjustment of the main oscillator tuning condenser is never necessary, the vernier lever alone providing all the frequency variation necessary for different operating requirements.

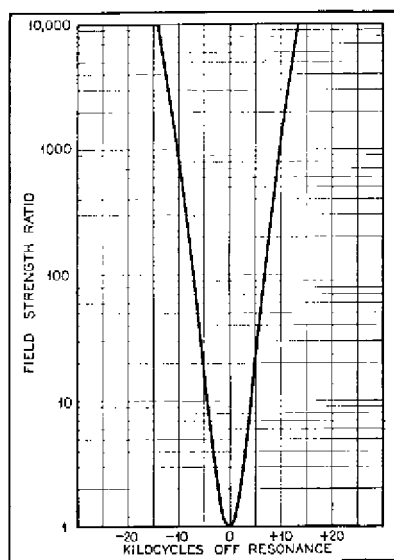

Fig. 6

the case if some of its output were allowed to couple with the first intermediate stage. Such independence of action is highly desirable for reliable C.W. reception, since it is substantially constant irrespective of the field strength of incoming signals. Any operator accustomed to a regenerative receiver will appreciate this advantage. In addition, adequate shielding is necessary to prevent harmonics of the I.F. oscillator from reaching the receiver input, where they might prove troublesome.

The whole question of shielding has been very carefully worked out and is culminated in an all-metal cabinet which encloses the entire receiver. Made of heavy gauge, patent levelled steel with black crinkle finish, this cabinet constitutes a handsome housing for the receiver and in addition limits all pickup to that afforded by the antenna itself. Fifteen ventilating louvres provide ample circulation of air for heat dissipation.

#### Performance Data

Complete sensitivity and selectivity tests of the receiver have been made by one of the best known and best equipped laboratories in the country. The tests were made for their own files, but a copy of their report was forwarded to this company. Their report on the sensitivity of the receiver was especially significant. No graph showing maximum sensitivity plotted against signal frequency was furnished, since the laboratory considers such measurements at small fractions of one microvolt unreliable. Instead they report a sensitivity for standard 50 milli-watts output, of better than one micro-volt absolute (equivalent to  $\frac{1}{4}$  micro-volt per meter) throughout the entire range of the receiver *with a signal to noise ratio of four to one*. This test was made with a carrier modulated 30% at 400 cycles. Inasmuch as a four-to-one signal to noise ratio corresponds to a crisp clear signal this test demonstrates conclusively both the

While this feature (the intermediate oscillator) was designed primarily for the reception of pure C.W. code signals, it is also extremely useful in other respects. When turned on, a whistle will be heard whenever any carrier wave is crossed during the process of tuning. By means of the zero beat method any such carrier can be quickly tuned to precise resonance, after which the oscillator may be turned off. In case the carrier is that of a phone transmitter voice or music will then be heard.

The intermediate oscillator tube and its associated circuits are completely shielded from the rest of the receiver. In this way its action is entirely independent of the other receiver adjustments, especially the sensitivity control, which would not be

high sensitivity and low inherent noise level of the "Pro." When pressed for an opinion the engineer in charge of the tests admitted that the sensitivity of the "Pro" would probably be rated at a few hundredths of a micro-volt per meter by ordinary test methods.

The overall selectivity of the receiver is shown in Fig. 6. This curve was taken at 3,750 K.C. and is representative of the selectivity at all other frequencies within the tuning range of the receiver. While the input circuit does not contribute to selectivity to an extent which varies with signal frequency, its effect on the overall characteristic is negligible compared to that of the intermediate amplifier, which of course remains constant irrespective of the adjustment of the input circuits.

#### *Antenna Systems*

No special type antenna is needed though various types of balanced antenna systems such as doublets often provide improved reception at high frequencies. For proper operation of such a system the primary of the antenna coupler in the receiver should not be grounded. In the Comet "Pro" a three terminal "Ant-Gnd" block is used. The two "A" terminals are connected to the ends of the primary of the W.L. coil and the "G" terminal is connected to the chassis. The two leads from any balanced antenna system may therefore be connected to the two "A" terminals. When the conventional Antenna and Ground arrangement is used a jumper should be connected from the "G" terminal to the adjacent "A" terminal, and then to the ground wire. The remaining "A" terminal should then be connected to the antenna. When using a balanced antenna system connected to the two "A" terminals, the "G" terminal may or may not be connected to ground depending on which condition yields better results.

#### *Description of Crystal Model*

This model possesses all of the advantages of the standard model previously described plus the additional selectivity and "single signal" feature afforded by a quartz crystal filter which may be cut in or out by means of a front panel switch. Illustration at right shows crystal holder, on the panel, and filter unit with part of shield removed to show air tuned units.

The "Pro" crystal filter circuit (patent applied for) is new and differs greatly from the "single signal" types of filters described in various radio publications. In the first place it permits the receiver to be operated as a standard receiver without sacrificing any of its original sensitivity and selectivity. Secondly, it provides series and parallel selectivity simultaneously. This permits parallel elimination of a strong heterodyne without sacrificing the sharp, peaked characteristic of the series connection. In the third place, this greatly increased selectivity is accomplished with substantially no loss in signal strength when receiving pure C.W. signals.

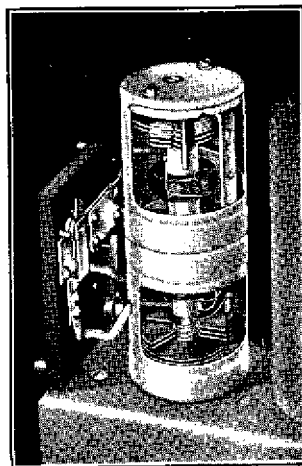

*Crystal Units*

The curves of Fig. 7 clearly illustrate the tremendous gain in selectivity afforded by the addition of a quartz crystal filter to a receiver already noted for its selectivity. The outer curve enclosing the single shaded area represents the response characteristic of a standard Comet "Pro." The inner, cross shaded curve, shows the selectivity of the standard "Pro" receiver with the quartz crystal filter in circuit. The crystal used in the filter resonates at 465 k.c. and the six tuned circuits of the L.F. amplifier are accurately adjusted to the same frequency. The beating oscillator was adjusted to exactly 464 k.c. to produce a 1,000 cycle tone when receiving a 465 k.c. signal (converted from, say, a 7,120 k.c. incoming signal). Exactly at 464 k.c. and for a few cycles on either side is the sub-audible or "zero beat" area which is illustrated by the gap in the curves and the white strip in the shaded areas. The inner, or crystal filter curve, shows the needle point top changing to concave sides typical of all low loss single

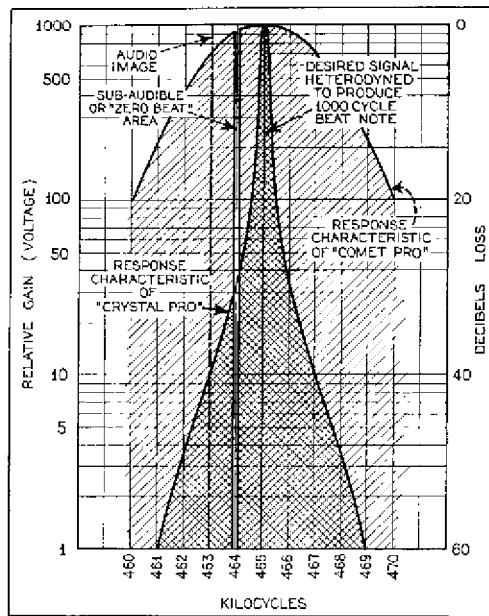

Fig. 7

circuits. The convex shoulders at the lower part of the curve are caused by the L.F. tuned circuits beginning to add substantially to the overall selectivity. With the crystal filter cut in the reception of the 7,120 k.c. signal with its 7,118 and 7,122 k.c. interference assumes an entirely different complexion. Assuming the beat oscillator to be adjusted at 464 k.c. it will be seen that although the 463 k.c. (originally 7,118 k.c.) interference will still produce an "audio image," its intensity will be only 1/100 that of the desired signal, and therefore negligible. The 467 k.c. (originally 7,122 k.c.) interference will not only produce a 3,000 cycle tone but in addition will also be reduced to 1/100 intensity. The above intensity ratios are based on the assumption that all three waves have the same field strength. Of course, such is rarely the case. But

with this degree of selectivity afforded by the filter, both interfering signals could be considerably stronger than the signal without rendering it unreadable. It is difficult if not impossible to determine definite field strength ratios limiting reception with such a filter, since so much depends on the operator's ability as well as the actual character of the waves themselves. The selectivity curve with the crystal cut in as shown in Fig. 7 was made with the elimination control set at neutral. In that position the two sides of the response curve are approximately similar and the filter affords the maximum *overall* selectivity. But under practical operating conditions, while several stations may cause some degree of interference, there is frequently one interfering wave which is so much stronger than the desired signal that even the selectivity described above will prove insufficient. When such is the case the elimination control can be adjusted to provide maximum attenuation for the frequency of this troublesome wave.

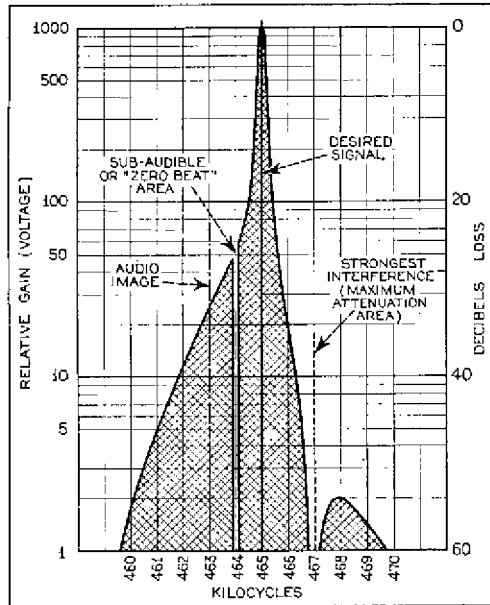

Fig. 8

As an illustration, consider the case of the signal and two interfering waves mentioned above. If the 467 k.c. interference were so strong that the 3,000 cycle tone produced by it caused serious interference with the 1,000 cycle tone produced by the signal, the elimination control could be adjusted to provide maximum attenuation at 467 k.c. The response curve of the filter would then be as shown in Fig. 8. Here the attenuation at 467 k.c. is so great that the 3,000 cycle beat note would no longer be troublesome even though the interference which produced it were several thousand times as strong as the desired signal. While the attenuation at "audio image" has been somewhat lessened in the process it is still over 40 times or 32 D.B. By means of this "elimination control" this "area of maximum attenuation" can be shifted at will throughout a range of approximately five thousand cycles on either side of the resonant frequency of

the crystal itself. If an extreme degree of "audio image" suppression is desired the elimination control can be set to produce maximum attenuation at 463 k.c. Then the audio image suppression ratio will be nearly 10,000 (80 D.B.) instead of 100 (40 D.B.) as normally obtained with the elimination control at neutral.

As previously stated, the quartz crystal filter greatly attenuates side bands due to any type of carrier modulation. Nevertheless, in practice it has been found possible to receive intelligible speech from phone stations by tuning the carrier very accurately and increasing the volume control setting somewhat beyond normal. The weakening effect of the crystal filter is due to the demodulation of such a sharp circuit, and is not an evidence of circuit losses. This is of very great advantage in the crowded amateur phone bands, since heterodyne whistles which would make reception impossible without the crystal filter are greatly reduced or eliminated altogether. The elimination control is especially effective as an aid to phone reception. Many times the modulation of a phone signal is almost completely obliterated by an extremely powerful heterodyne beat note of say 500 or 1,000 cycles.

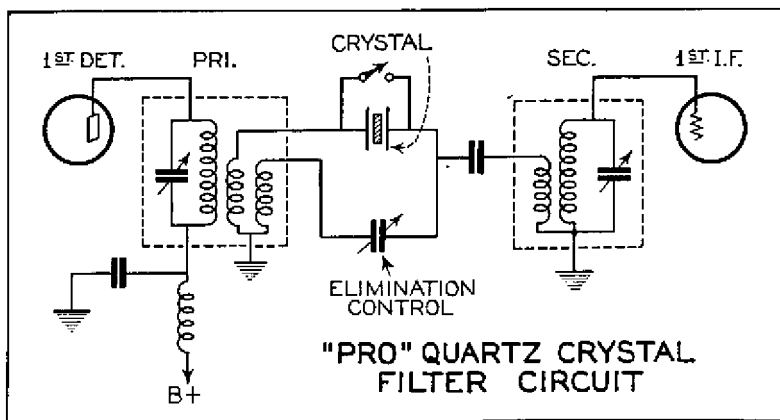

Fig. 9

When using an ordinary receiver, even of exceptional selectivity, reception of speech under such a handicap is absolutely impossible. By using the quartz crystal filter accurately tuned to the desired carrier, the heterodyne beat can generally be reduced by means of the elimination control to the point where speech can be heard successfully. The adjustment of this control is exceedingly simple as it has no noticeable effect on anything but the heterodyning carrier which it is desired to eliminate.

The circuit used is shown in Fig. 9. Since it seemed highly desirable to maintain the original selectivity and sensitivity of the "Pro" when the crystal was cut out it was necessary to preserve the general design of the first I.F. transformer with its two high grade tuned circuits. Also it was considered advisable to work the crystal into a tuned circuit rather than into a non-reactive load such as a grid leak. For these reasons a special first I.F. transformer was

designed, having its primary and secondary shielded from each other in separate compartments. The quartz crystal is used as a coupling means between primary and secondary. By merely short-circuiting the two plates of the crystal holder, therefore, the circuit becomes substantially a standard Comet "Pro," while with the switch open the only coupling path is through the crystal. Since the series impedance of the quartz crystal at resonance is relatively low it was not considered feasible to use it as a direct coupling between two such high impedance circuits as the primary and secondary of the air tuned I.F. transformer. For this reason impedance matching windings were added to both circuits of the special I.F. transformers and the crystal connected between these additional windings. Inasmuch as the full filter action of the quartz crystal can only be obtained when the by-passing action of the capacity of the holder is eliminated, the extra winding on the primary of the special transformer is in two equal sections wound in such a way that they constitute a center-tapped balanced winding. One of these windings provides a voltage exactly equal to, and  $180^\circ$  out of phase with, the voltage across the crystal holder. This voltage is impressed across a small variable condenser which constitutes the "elimination control," whose capacity can be adjusted to a value slightly less than, slightly more than, or exactly equal to the capacity of the crystal holder. When its capacity is adjusted to equal that of the holder maximum selectivity is obtained from the crystal as shown in Fig. 7.

### *Special Models*

A battery operated model is available, using four "77" 's, two "78" 's and one "42". These tubes are the highly efficient non-microphonic, automobile type, drawing only .3 amperes at 6.3 volts. Where only 110 or 220 volt direct current is available, an A.C. receiver should be employed in connection with a 110 watt motor-generator.

### *Loud Speakers*

All "Pro" Models can be used with magnetic or self-excited dynamic speakers with an input impedance of approximately 4,000 ohms. The special "Pro" speaker is a permanent magnetic dynamic type, mounted in a solid birch cabinet, black crystal finished to match the receiver.

#### **"PRO" MANUALS**

Manuals containing complete instructions covering installation and operation are supplied with each receiver. These manuals, profusely illustrated, contain data on circuits, theory, performance and servicing, together with a complete set of tuning charts.

They are available separately at a cost of ten cents per copy.

*"Pro" Manual No. 1—Standard "Pro"*

*"Pro" Manual No. 2—Crystal "Pro"*

# HAMMARLUND COMET "PRO"

## PRICE LISTS ON ALL MODELS

*Licensed under RCA and Hazeltine patents*

### STANDARD MODELS

[All models come equipped complete with four sets of coils to cover 15 to 250 meters]

<u>Description</u>	<u>List</u>
<u>A C Type</u>	
"Pro" Receiver in metal cabinet, with tubes .....	\$162.00
"Pro" Chassis, with tubes .....	147.00
Metal Cabinet only .....	15.00
<u>Battery Type</u>	
"Pro" Receiver in metal cabinet, with tubes .....	\$142.00
"Pro" Chassis, with tubes .....	127.00
Metal Cabinet only .....	15.00

### CRYSTAL MODELS

<u>A C Type</u>	
"Pro" XTAL Receiver in metal cabinet, with tubes .....	\$192.00
"Pro" XTAL Chassis, with tubes .....	177.00
Metal Cabinet only .....	15.00
<u>Battery Type</u>	
"Pro" XTAL Receiver in metal cabinet, with tubes .....	\$172.00
"Pro" XTAL Chassis, with tubes .....	157.00
Metal Cabinet only .....	15.00

### ACCESSORIES

#### Speakers

"Pro" 8" Permanent Magnet Dynamic Speaker in solid birch cabinet, black crystalline finish matching "Pro" metal cabinet.....	\$ 25.00
"Pro" 8" Permanent Magnet Dynamic Speaker (unit only) .....	15.00
Jensen A C Concert Speaker (unit only) .....	60.00

#### Coils

"Pro" Tuning Coils for 8 to 16 meters, per set.....	\$ 5.00
"Pro" Tuning Coils for 250 to 550 meters, per set.....	5.00

[A C receivers listed herewith are for 110-115 volts, 50 to 60 cycles. Receivers for 25 or 40 cycles, 125, 140, 230 or 250 volts are also available at an additional list price of \$10.]

*"All prices subject to change without notice."*

**The HAMMARLUND MANUFACTURING CO., Inc.**

424-438 West 33rd Street, New York