

ALINCO

VHF FM Mobile Transceiver

DR-B185MKII

Instruction Manual

Thank you for purchasing your new Alinco transceiver. Please read this manual carefully before using the product to ensure full performance, and keep this manual for future reference as it contains information on after-sales services. In case addendum or errata sheets are included with this product, please read those materials and keep them together with this instruction manual for future reference.

NOTE: DR-B185MKII may be delivered to you after dealer-programming. In such cases, please ask your dealer about the available features in your unit and how to operate this unit.

Features and functions may be limited due to dealerprogramming.

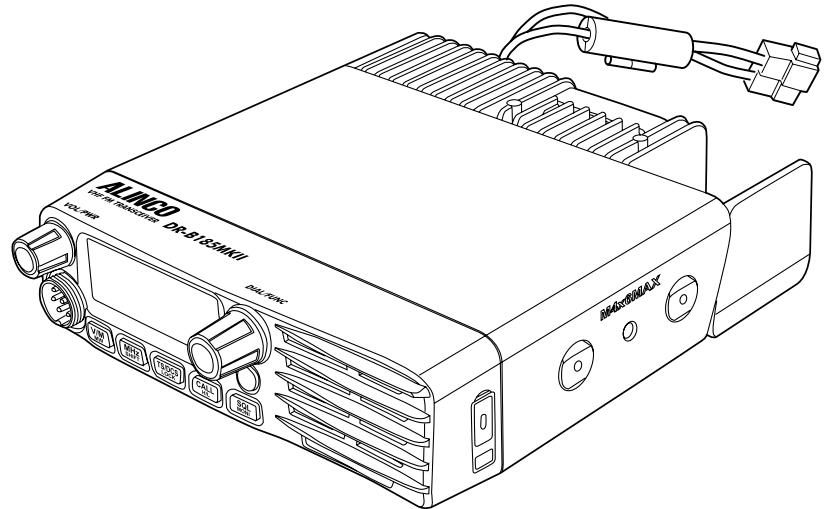

[MEMO]

Introduction

Thank you very much for purchasing this excellent Alinco transceiver. Our products are ranked among the finest in the world. This radio has been manufactured with state of the art technology and it has been tested carefully at our factory. It is designed to operate to your satisfaction for many years under normal use.

Please read this manual completely from the first page to the last, to learn all the functions the product offers. It is important to note that some of the operations may be explained in relation to information in previous chapters. By reading just one part of the manual, you may risk not understanding the complete explanation of the function.

■ Safety

It is important that the operator is aware of, and understands, hazards common to the operation of any transceiver.

Before transmitting

There are many radio stations operating in proximity to the frequency ranges this product covers. Be careful not to cause interference when transmitting around such radio stations.

■ Covering ranges

It may vary drastically depending on the type and location of antenna system. Please consult your dealer for details as DR-B185MKII requires an external antenna.

■ Lightning

Please note that no car provides adequate protection of its passengers or drivers against lightning. Therefore, Alinco will not take responsibility for any danger associated with using its radios or inside the car during lightning.

■ Enclosure protection

This transceiver is NOT water and dust protected. Avoid contacts with water and dust, and if wet or dirty, immediately wipe them out with clean

dry cloth. This product is NOT anti-explosive.

Never use in close vicinity to explosive gas, combustible dust, on an oil rig or in an open mine.

■ Important Notice

The utility software may be available to distributors/dealers only.

Programming cable is optional. The manufacturer will not release the software to unauthorized party so please contact your dealer for details. This product may be delivered to the consumer after being preprogrammed with the operating parameters, then certain operation may be disabled for user-accesses. The manufacturer and distributors are not aware of details of such dealer-programming. Therefore, please contact to your dealer in case any technical assistance may be necessary.

■ PC Programming

To set up and operate DR-B185MKII series Windows based PC and USB Type C cable is necessary. Software should be available from your dealer; many of them posts software on their sites for free downloads.

- Follow the given instruction to install a driver software provided with the Utility software first then the Utility. The driver may not be necessary depending on the OS you use.
- After PC cable is ready for use, connect it with USB type C plug on the side of the front panel of DR-B185MKII. You may disregard the power on/off of the radio while connecting the cable.
- Follow the instruction of software for programming. Instruction appears at the bottom of the program interface. You may need a preprogrammed data file called Codeplug for easier setup. Codeplugs may be available through amateur radio related sites on the internet or through your dealer.

Features

- **Output power selectable (Hi/Mid/Lo/Sma)**
- **PC-programmable**
- **Alphanumeric name tags**
- **Voice Comander (Reduce Noise & enhance audio clarity)**
- **Optional Inversion Scramble(MK2 only, not TMK2/EMK2)**
- **Sub-tone (CTCSS/DCS) Encode/Decode, DTMF/ANI, 2-tone and 5-tone**
- **Various scan modes, Key lock, Wide/Narrow operations and more at NO extra costs.**
- **90W Power Maximum**
- **Radio stun/kill/revive functions to protect your communication security.**

Conformity Symbols



Hereby, Alinco Inc. declares that the versions of DR-B185MKII which have the "CE" symbol on the product, comply with the essential requirements of the Radio Equipment Directive, 2014/53/EU, and the restriction of the use of certain hazardous substances in electrical and electronic equipment Directive, 2011/65/EU. The full text of the EU declaration of conformity is available at <https://alinco.com/Ce/>.

FOR HOME OR OFFICE USE

Information in this document is subject to change without notice or obligation. All brand names and trademarks are the property of their respective owners. Alinco cannot be liable for pictorial or typographical inaccuracies. Some parts, options and/or accessories are unavailable in certain areas. Changes or modifications not expressly approved by the party responsible for compliance could void the user's authority to operate the equipment.

■ FCC INFORMATION

This equipment has been tested and found to comply with the limits for a Class B digital device, pursuant to part 15 of the FCC Rules. These limits are designed to provide reasonable protection against harmful interference in a residential installation. This equipment generates, uses and can radiate radio frequency energy and, if not installed and used in accordance with the instructions, may cause harmful interference to radio communications. However, there is no guarantee that interference will not occur in a particular installation. If this equipment does cause harmful interference to radio or television reception, which can be determined by turning the equipment off and on, the user is encouraged to try to correct the interference by one or more of the following measures:

- Reorient or relocate the receiving antenna.
- Increase the separation between the equipment and receiver.
- Connect the equipment into an outlet on a circuit different from that to which the receiver is connected.
- Consult the dealer or an experienced radio/TV technician for help.

CAUTION: Changes or modifications to this device, not expressly approved by Alinco Inc., could void your authority to operate this device under FCC regulations.

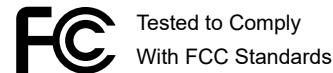

FOR HOME OR OFFICE USE

Information in this document is subject to change without notice or obligation. All brand names and trademarks are the property of their respective owners. Alinco cannot be liable for pictorial or typographical inaccuracies. Some parts, options and/or accessories are unavailable in certain areas. Changes or modifications not expressly approved by the party responsible for compliance could void the user's authority to operate the equipment.

This device complies with Part 15 of the FCC Rules. Operation is subject to the following two conditions: (1) This device may not cause harmful interference, and (2) this device must accept any interference received, including interference that may cause undesired operation.

Copyright © All rights reserved. No part of this document may be reproduced, translated or transcribed in any form or by any means without the prior permission of Alinco. Inc., Osaka, Japan, English Edition Printed in China



SAFETY TRAINING INFORMATION

Your Alinco radio generates RF electromagnetic energy during transmit mode. This radio is designed for and classified as "Occupational Use Only", meaning it must be used only during the course of employment by individuals aware of the hazards, and the ways to minimize such hazards. This radio is NOT intended for use by the "General Population" in an uncontrolled environment. This radio has been tested and complies with the FCC RF exposure limits for "Occupational Use Only". In addition, your Alinco radio complies with the following Standards and Guidelines with regard to RF energy and electromagnetic energy levels and evaluation of such levels for exposure to humans:

- FCC OET Bulletin 65 Edition 97-01 Supplement C, Evaluating Compliance with FCC Guidelines for Human Exposure to Radio Frequency Electromagnetic Fields.

- American National Standards Institute (C95.1-2019), IEEE Standard for Safety Levels with Respect to Human Exposure to Electric, Magnetic, and Electromagnetic Fields, 0 Hz to 300 GHz.

- American National Standards Institute (C95.3-2021), IEEE Recommended Practice for Measurements and Computations of Electric, Magnetic, and Electromagnetic Fields with Respect to Human Exposure to Such Fields, 0 Hz to 300 GHz.

- The antennas, batteries, belt clips, speaker-microphone, and other accessories that are listed in "OPTIONS" of the INSTRUCTIONS sheet, are authorized for use with this product. Use of accessories other than those specified may result in RF exposure levels exceeding the FCC requirements for wireless RF exposure.



CAUTION

To ensure that your exposure to RF electromagnetic energy is within the FCC allowable limits for occupational use, always adhere to the following guidelines:

- DO NOT operate the radio without a proper antenna attached, as this may damage the radio and may also cause you to exceed FCC RF exposure limits. A proper antenna is the antenna supplied with this radio by the manufacturer or antenna specifically authorized by the manufacturer for use with this radio.
- DO NOT transmit for more than 50% of total radio use time ("50% duty cycle"). Transmitting more than 50% of the time can cause FCC RF exposure compliance requirements to be exceeded. The radio is transmitting when the LED indicator lights red. You can cause the radio to transmit by pressing the "PTT" switch.
- ALWAYS keep the antenna at least 2.5 cm (1 inch) away from the body when transmitting and only use the Alinco belt-clips listed in "OPTIONS" of the instruction sheet when attaching the radio to your belt, etc., to

ensure FCC RF exposure compliance requirements are not exceeded. To provide the recipients of your transmission the best sound quality, hold the antenna at least 5 cm (2 inches) from your mouth, and slightly off to one side. The information listed above provides the user with the information needed to make him or her aware of RF exposure, and what to do to assure that this radio operates with the FCC RF exposure limits of this radio.

• **FCC SDoC**

This device complies with Part 15 of the FCC Rules. Operation is subject to the condition that this device does not cause harmful interference.

Model Name: DRB185TMKII

Responsible Party: ALINCO, Inc. Yodoyabashi Dai-bldg 13F

4-4-9 Koraibashi, Chuo-ku, Osaka 541-0043 Japan

Phone: +81-6-7636-2362 <http://www.alinco.com>

E-mail: export@alinco.co.jp

• **Trademark / Disclaimer**

Alinco is not responsible for the destruction, damage to, or performance of any Alinco or non-Alinco equipment, if the malfunction is because of:

-Force majeure, including, but not limited to, fires, earthquakes, storms, floods, lightning, other natural disasters, disturbances, riots, war, and/or radioactive contamination.

-The use of Alinco transceivers with any equipment that is not manufactured or approved by Alinco.

Alinco and the Alinco logo are registered trademarks of Alinco Incorporated in Japan, the United States, and other countries.







All other products or brands are registered trademarks or trademarks of their respective holders.

• **DISPOSAL**

The crossed-out wheeled-bin symbol on your product, literature, or packaging reminds you that in the European Union and many other legal and local public entities, all electrical and electronic products, batteries, and accumulators (rechargeable batteries) must be taken to designated collection locations at the end of their working life. Do not dispose of these products as unsorted municipal waste. Dispose of them according to the laws in your area.













To prevent any hazard during operation of Alinco's radio product, in this manual and on the product you may find symbols shown below. Please read and understand the meanings of these symbols before starting to use the product.

 Danger	This symbol is intended to alert the user to an immediate danger that may cause loss of life and property if the user disregards the warning.
 Alert	This symbol is intended to alert the user to a possible hazard that may cause loss of life and property if the user disregards the warning.
 Caution	This symbol is intended to alert the user a possible hazard that may cause loss of property or injure the user if the warning is disregarded.
	Alert symbol. An explanation is given.
	Warning symbol. An explanation is given.
	Instruction symbol. An explanation is given.

ALERT





■ Environment and condition of use:

-  Do not drive while handling the radio for your safety. It is recommended that you check local traffic regulations regarding the use of radio equipment while driving.





-  Do not use this product in close proximity to other electronics devices, especially medical ones. It may cause interference to those devices.
-  Keep the radio out of the reach of children.
-  In case a liquid leaks from the product, do not touch it. It may damage your skin.
Rinse with plenty of cold water if the liquid contacted your skin.
-  Never operate this product in facilities where radio products are prohibited for use such as aboard aircraft, in airports, in ports, within or near the operating area of business wireless stations or their relay stations.
-  Use of this product may be prohibited or illegal outside of your country. Be informed in advance when you travel.
-  The manufacturer declines any responsibilities against loss of life and/or property due to a failure of this product when used to perform important tasks like life-guarding, surveillance, and rescue.
-  Do not use multiple radios in very close proximity. It may cause interference and/or damage to the product(s).
-  The manufacturer declines any responsibilities against loss of life and property due to a failure of this product when used with or as a part of a device made by third parties.
-  Use of third party accessory may result in damage to this product. It will void our warranty for repair.

WARNING

■ Handling this product:

-  Be sure to reduce the audio output level to minimum before using a headset. Excessive audio may damage hearing.
-  Do not open the unit without permission or instruction from the manufacturer. Unauthorized modification or repair may result in electric shock, fire and/or malfunction.
-  Do not operate this product in a wet place such as shower room. It may result in electric shock, fire and/or malfunction.
-  Do not place conductive materials, such as water or metal in close proximity to the product. A short-circuit to the product may result in electric shock, fire and/or malfunction.
-  Do not touch the heatsink (on/around the unit mostly found on mobile-base units) as it may become very hot during/after the operation that may risk burn your skin.

■ About power-supply:

-  Use only appropriate, reliable and certified power supply of correct voltage and capacity.
-  Do not connect cables in reverse polarity. It may result in electric shock, fire and/or malfunction.
-  Do not plug multiple devices including the power-supply into a single wall outlet. It may result in overheating and/or fire.
-  Do not handle a power-supply with a wet hand. It may result in electric shock.
-  Securely plug the power-supply to the wall outlet. Insecure installation may result in short-circuit, electronic shock and/or fire.



Do not plug the power-supply into the wall outlet if the contacts are dirty and/or dusty. Short circuiting and/or overheating may result in fire, electric shock and/or damage to the product.



Do not modify or remove fuse-assembly from the DC-cable. It may result in fire, electric shock and/or damage to the product.

■ In case of emergency:

In case of the following situation(s), please turn off the product, switch off the source of power, then remove or unplug the power-cord. Please contact your local dealer of this product for service and assistance. Do not use the product until the trouble is resolved. Do not try to troubleshoot the problem by yourself.

- When a strange sound, smoke and or strange odor comes out of the product.
- When the product is dropped or the case is broken or cracked.
- When a liquid penetrated inside.
- When a power-cord (including DC-cables, AC-cables and adapters) is damaged.



For your safety, turn off then remove all related AC-lines to the product and its accessories including the antenna if a thunderstorm is likely.







Turn off the unit, remove the mobile antenna from its base and keep it in the vehicle if a thunderstorm is likely. Please read cautions regarding the lightning-protection on page 9 also.



■ Maintenance



Do not open the unit and its accessories. Please consult with your local dealer of this product for service and assistance.

 **CAUTION****■ Environment and condition of use:** Do not use the product in proximity to a TV or a radio. It may cause interference or receive interference. Do not install in a humid, dusty or insufficiently ventilated place. It may result in electric shock, fire and/or malfunction. Do not install in an unstable or vibrating position. It may result in electric shock, fire and/or malfunction when/if the product falls. Do not install the product in proximity to a source of heat and humidity such as a heater or a stove. Avoid placing the unit in direct sunlight.

Do not modify, dismantle, incinerate, or immerse the batteries that may be used in accessories you use with this product. Please check your local regulations for details on recycling option or disposal of the batteries in your area.

 DO NOT operate the radio without a proper antenna attached, as this may damage the radio and may also cause you to exceed FCC RF exposure limits. A proper antenna is the antenna supplied with this radio by the manufacturer or antenna specifically authorized by the manufacturer for use with this radio.**■ About transceiver** Do not connect devices other than specified ones to the jacks and ports on the product.
It may result in damage to the devices. DO NOT transmit for more than 50% of total radio use time ("50% duty cycle"). Transmitting more than 50% of the time can cause FCC RF exposure compliance requirements to be exceeded.

The radio is transmitting when the LED indicator lights red. You can cause the radio to transmit by pressing the "PTT" switch.



ALWAYS keep the antenna at least 2.5 cm (1 inch) away from the body when transmitting and only use the Alinco belt-clips listed in "OPTIONS" of the instruction sheet when attaching the radio to your belt, etc., to ensure FCC RF exposure compliance requirements are not exceeded. To provide the recipients of your transmission the best sound quality, hold the antenna at least 5 cm (2 inches) from your mouth, and slightly off to one side. The information listed above provides the user with the information needed to make him or her aware of RF exposure, and what to do to assure that this radio operates with the FCC RF exposure limits of this radio.



Turn off and remove the power-source (AC cable, DC cable etc) from the product when the product is not in use for extended period of time or in case of maintenance.



Use a clean, dry cloth to wipe off dirt and condensation from the surface of the product.

Never use thinner or benzene for cleaning.

■ About power-supply

Use only reliable power supply of specific DC output range and be mindful of the polarity of the cables and DC jack.



Always turn off the power supply when connecting or disconnecting the cables.



When using an external antenna, make sure that the antenna ground is not common with the ground of the power supply.



When a transceiver is powered from an external DC power source, make sure that this power supply has approval to the level of IEC/EN 60950-1.

CONTENTS

Supplied Accessories	1	Turn On/Off Voice Comander Function	14
Supplied Accessories	1	Offset Frequency Direction And Setting	14
Initial Installation	2	Keyboard Lock.....	15
Mobile Installation.....	2	Display Current Voltage.....	15
DC Power Cable Connection.....	3	Automatic Dialer Settings	15
Power Supply Voltage Display.....	4	Transmitting Edited DTMF Tones in The Auto-Dialer Memory	15
Antenna Connection	5	Emergency Alarm	15
Accessories Connections	5	Programmable [PF] Key	16
Getting Acquainted	7	APRS Sends (Not Supported on MKII).....	16
Front Panel.....	7	APRS Reception (Not Supported on MKII).....	16
Rear Panel.....	8	Parameter Setting Mode	16
Display.....	8	Menu Function Options	17
Microphone	9	Step Frequency Setting	17
Operating Mode	10	DTMF, 2Tone or 5Tone Signaling	17
Key Operations	11	Select 2TONE Signaling Encoding Group.....	18
Power On and Off The Mobile Radio	11	Select 5TONE Signaling Coding Group	18
Volume Adjustment.....	11	Select DTMF Signaling Encoding Group.....	18
Switching Between Working Modes	11	Signaling Group Setting.....	19
Channel Switch Adjusts Frequency / Channel.....	11	High And Low Power Selection	19
Receive.....	11	Wide And Narrow Band Settings	19
Make A Call.....	11	Prohibited Transmission Setting	20
Send Single Tone Pulses.....	12	Busy Channel Lock Setting	20
Send Optional Signaling	12	Channel Name Editing Settings.....	20
Edit Channel	12	Frequency Reverse	21
Delete Channel.....	12	Talk Around Function	21
Squelch Off / Temporary Squelch Off	12	Voice Comander Function	21
Squelch Level Setting.....	12	Voice Encryption Settings.....	22
Frequency/Channel Scan.....	13	APRS Receiving Function Switch Setting	22
CTCSS/DCS Encode And Decode Settings	13	Local DTMF ID query	22
CTCSS Scanning	13	Local 5-TONE ID query	22
DCS Scanning.....	14	Prompt Sound Setting	22
High, Medium, and Low Power Options	14	Time-Out Timer Setting.....	23

CONTENTS

APO (Auto Power Off)	23	Frequency Step	32
DTMF Transmission Time Setting	23	Optional Signaling	32
Squelch Level Setting	24	Scan Skip	33
Scan Pause Time Setting	24	Frequency/Channel Scan	33
Backlight Brightness Selection Setting	24	Busy Channel Lockout.....	33
Pilot Frequency Selection	25	Reverse TX/RX.....	33
Display Type Settings	25	TOT (Time-out timer).....	33
Enable/Disable Password Function	25	CTCSS/DCS Encode and Decode	33
Address Book Settings	26	Talk Around.....	34
Noise Reduction for RX Audio	26	BEEP Sound.....	34
Noise Reduction for TX Audio	26	HIGH/MID/LOW Power Selection	34
Fan Switch	27	LCD Backlight.....	34
FM Switch	27	Maintenance.....	35
AM Switch (Not Supported on MKII)	27	Default Setting after Resetting DR-B185MKII	35
GPS Switch (Not Supported on MKII).....	27	Frequency Coverage	35
APRS PTT Setting (Not Supported on MKII)	28	Trouble Shooting	35
APRS Power Setting (Not Supported on MKII).....	28	Specifications For DR-B185MKII	36
APRS Bandwidth Setting (Not Supported on MKII)	28	Specifications For DR-B185TMKII/EMKII	37
APRS Frequency Setting (Not Supported on MKII)	29	Appendix	38
APRS Text Settings (Not Supported on MKII).....	29	50 Groups CTCSS Tone Frequency(Hz).....	38
APRS Path Setting (Not Supported on MKII).....	29	1024 Groups DCS Code.....	38
APRS Interval Setting (Not Supported on MKII)	30		
APRS Beacon Settings (Not Supported on MKII)	30		
Restore Factory Settings	31		
Microphone Operation	32		
Keypad Lock.....	32		
Transmitting DTMF By Microphone KeyPAD.....	32		
Function Setup By Microphone Keypad	32		
Switches between VFO and Channel Mode.....	32		
Short Calling	32		

SUPPLIED ACCESSORIES

Carefully unpack to make sure the following items are found in the package in addition to this manual:

- Transceiver
DR-B185MKII

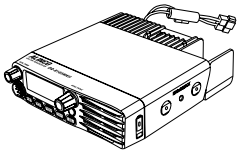

- Microphone EMS-74
(with DTMF keyboard)

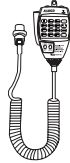

- Mobile Mounting
Bracket

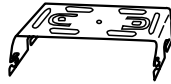

- DC Power Cable with
Fuse Holder



- Hardware Kit for Bracket

Black screws
(M4X8mm)
4PCS



Tapping screws
(M5X8mm)
4PCS



S-Washer



- Spare Fuses



- User Manual



- GPS Antenna
EA-0289(Not supported on MKII)



The standard accessories may vary slightly depending on the version you have purchased. Please contact your local authorized Alinco dealer should you have any questions. Alinco and authorized dealers are not responsible for any typographical errors there may be in this manual. Standard accessories may change without notice.

Warranty Policy: Please refer to any enclosed warranty information or contact your authorized Alinco dealer / distributor for the warranty policy.

- In order to operate this product, a properly tuned antenna, its feedline with connectors and fixing hardware are necessary. Please consult with your dealer for details.

MOBILE INSTALLATION

The transceiver may be installed in any position in your car, where the controls and microphone are easily accessible and it does not interfere with the safe operation of the vehicle. If your vehicle is equipped with air bags, be certain your radio will not interfere with their deployment. If you are uncertain about where to mount the unit, contact your vehicle's dealer.



NOTE Prepare screwdriver to fasten and loosen screws.

1. Install the mounting bracket in the vehicle using the supplied self-tapping screws (4pcs) and flat washers (4pcs).

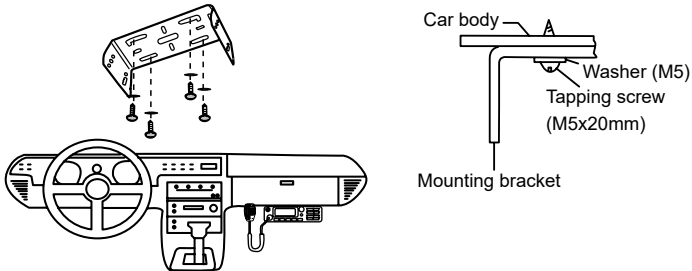

2. Position the transceiver, then insert and tighten the supplied hexagon SEMS screws.

- ▼ Double check that all screws are tightened to prevent vehicle vibration from loosening the bracket or transceiver.

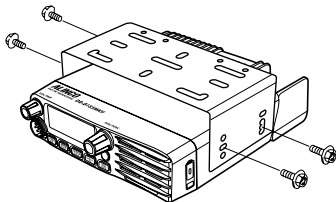

Caution:

Use only the provided screws otherwise you risk damaging the circuit board, components or fall-off of the unit.

- ▼ Determine the appropriate angle of the transceiver, using the 3 screw hole positions on the side of the mounting bracket.

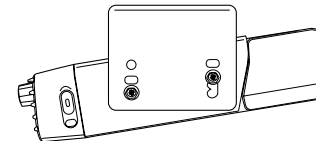
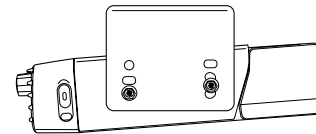
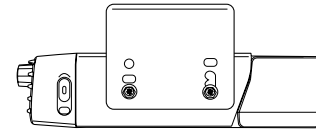

3. To remove the transceiver, unscrew all fixing hardware, and hold the transceiver in the way that it won't fall from bracket.

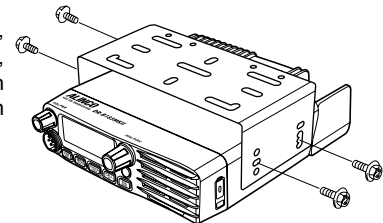

DC POWER CABLE CONNECTION

✕ MOBILE OPERATION

The vehicle battery must have a nominal rating of 12V. Never connect the transceiver to a 24V battery. Be sure to use a 12V vehicle battery that has sufficient current capacity. If the current to the transceiver is insufficient, the display may darken during transmission, or transmitting output power may drop excessively.

- Route the DC power cable supplied with the transceiver directly to the vehicle's battery terminals using the shortest path from the transceiver.
 - Never use the cigarette lighter socket as a DC source.
 - The entire length of the cable must be dressed so it is isolated from heat, moisture, and the engine secondary (high voltage) ignition system/cables.
- After installing cable, in order to avoid the risk of damp, please use heat-resistant tap to tie together with fuse box. Don't forget to reinforce whole cable.
- In order to avoid the risk of short circuit, please cut down connection with negative (-) of battery, then connect with radio.
- Confirm the correct polarity of the connections, then attach the power cable to the battery terminals; red connects to the positive (+) terminal and black connects to the negative (-) terminal.
 - Never remove the fuse holders from the cable.
- Reconnect any wiring removed from the negative terminal.

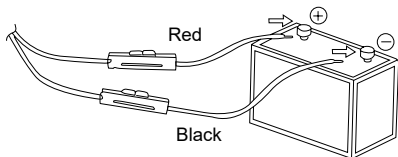

- Connect the DC power cable to the transceiver's power supply connector.

- Press the connectors firmly together until the locking tab clicks.

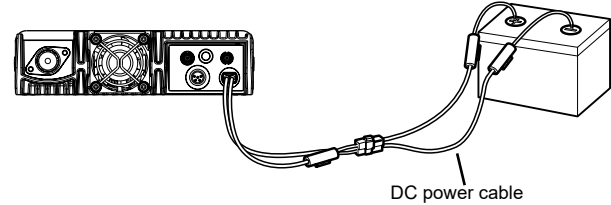

✕ FIXED STATION OPERATION

In order to use this transceiver for fixed station operation, you will need a separate 13.8V DC power supply (not included), Please contact local dealer to require.

The current capacity of your power supply must be 12A or more.

- Connect the DC power cable to the regulated DC power supply and ensure that the polarities are correct. (Red: positive, Black: negative).
 - Never directly connect the transceiver to an AC outlet.
 - Use the supplied DC power cable to connect the transceiver to a regulated power supply.
 - Do not substitute a cable with smaller gauge wires.
- Connect the transceiver's DC power connector to the connector on the DC power cable.
 - Press the connectors firmly together until the locking tab clicks.

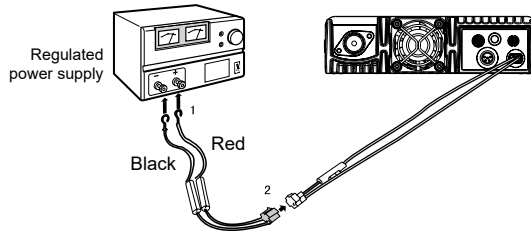

DC power cable with fuse holder

- ▼ Before connecting the DC power to the transceiver, be sure to switch the transceiver and the DC power supply OFF.
- ▼ Do not plug the DC power supply into an AC outlet until you make all connections.

✘ REPLACING FUSES

If the fuse blows, determine the cause, then correct the problem. After the problem is resolved, replace the fuse. If newly installed fuses continue to blow, disconnect the power cable and contact your dealer for assistance.

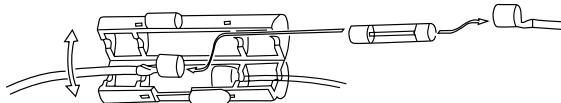

Fuse Location	Fuse Current Rating
Transceiver	15A
Supplied Accessory DC power cable	20A

Only use fuses of the specified type and rating, otherwise the transceiver could be damaged.

NOTE If you use the transceiver for a long period when the vehicle battery is not fully charged, or when the engine is OFF, the battery may become discharged, and will not have sufficient reserves to start the vehicle. Avoid using the transceiver in these conditions.

■ POWER SUPPLY VOLTAGE DISPLAY

After connecting the transceiver to the power supply, the supply voltage can be displayed on LCD by pressing the **FUNC** key together with the **MONI** key.

The display immediately changes as the voltage supply changes. It also displays voltage during transmission.

The transceiver will return to its normal operation when the power is turned ON/OFF or repeat above operation.

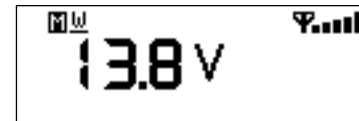

Important The range of displayed voltage is from 7V to 16V DC. Because the displayed value is estimated, please use a voltmeter when a more precise reading is desired.

ANTENNA CONNECTION

Before operating, install an efficient, well-tuned antenna. The success of your installation will depend on the type of antenna and its correct installation.

Use a 50Ω impedance antenna and low-loss coaxial feed-line that has a characteristic impedance of 50Ω, to match the transceiver input impedance. Coupling the antenna to the transceiver via feed-lines having an impedance other than 50Ω reduces the efficiency of the antenna system and can cause interference to nearby televisions, radio receivers and other electronic equipment.

Transmitting without first connecting an antenna or other matched load may damage the transceiver. Always connect the antenna to the transceiver before transmitting.



NOTE

All fixed stations should be equipped with a lightning arrester to reduce the risk of fire, electric shock, and transceiver damage.

ACCESSORIES CONNECTIONS**EXTERNAL SPEAKER**

If you plan to use an external speaker, choose a speaker with an impedance of 8Ω. The external speaker jack accepts a 3.5mm (1/8") mono (2-conductor) plug.

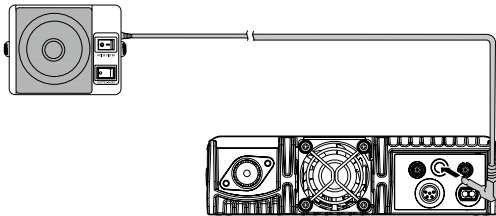

NOTE

External speaker adopt double port BTL, please care about the connection.
Do not use the speaker that requires grounding.

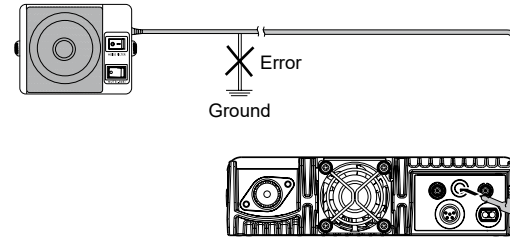
**MICROPHONE**

For voice communications, connect a provided microphone into the socket on the front of the main unit. Turn the ring firmly on the plug until it locks. Attach the supplied microphone hanger in an appropriate location using the screws included in the screw set.

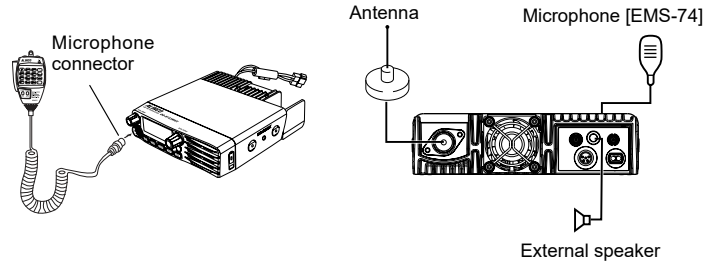

✘ USING AN INTERCOM

The DRB185MKII provides rear-panel jack for connection to an intercom or headsets with a TA5 mini XLR connector. When an intercom is connected, unplug the speaker mic from the radio so there is no echo.

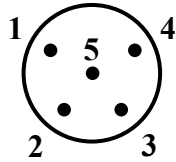

Pin 1: GRND(MIC-)

Pin 2: PTT

Pin 3: MIC+

Pin 4: SPK+

Pin 5: SPK-

FRONT PANEL

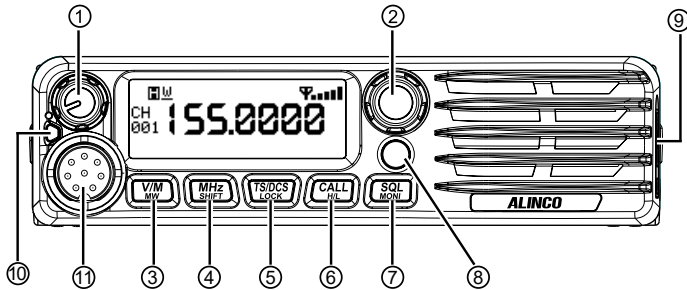

• Basic Functions

NO.	KEY	FUNCTION
1	POWER/VOL	Power switch / Adjust the volume level
2	FUNC/CH (channel switch)	Function keys; Change frequency, scanning direction, etc
3	V/M / MW	Conversion key between VFO mode and memory mode
4	MHz/SHIFT	Step key (1MHz)
5	TS/DCS / LOCK	Set values for CTCSS and DCS
6	CAL / H/L	Quick call key
7	SQL/MONI	Cancel muting
8	Programmable key/ Alarm	Pre-programmed functions. Press and hold more than 2 seconds to activate the alarm
9	Data Port	Used for data reading, writing, copying, and anti-theft alarm functions
10	TX/RX	Launch indicator light
11	Microphone connection end	Microphone connector

• First press the FUNC key, wait for the F symbol to display, and then press the following keys to activate the functions:

NO.	KEY	FUNCTION
2	FUNC/CH (channel switch)	Enter function settings, confirm and return, exit
3	V/M / MW	Data stored in memory channel
4	MHz/SHIFT	Set the difference frequency direction and difference frequency data
5	TS/DCS/LOCK	Set button lock function
6	CALL /H/L	Switching between HI/MID/LOW power
7	SQL/D	Enable/disable spread spectrum communication mode

• While holding down the FUNC key, press the following keys to activate the functions:

NO.	KEY	FUNCTION
3	V/M / MW	Delete memory channel content
4	MHz/SHIFT	Enter the wide and narrow bandwidth settings
5	TS/DCS/LOCK	Set up automatic dialing
7	SQL/D	Enter the power supply voltage indication mode

• Press and hold the following buttons continuously to achieve the function

NO.	KEY	FUNCTION
2	FUNC	Press and hold for 2s to enter the Setting mode
7	SQL	Activate monitoring function
1	Programmable key	Activate alarm function (requires software to write frequency)

REAR PANEL

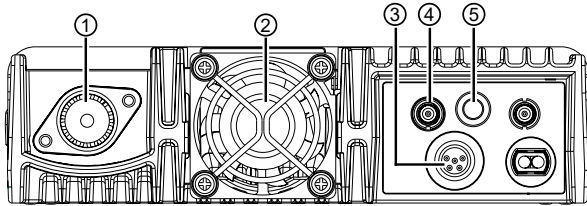

NO.	KEY	FUNCTION
1	Antenna	Connection for 50Ω coaxial cable and antenna. Connector is PL/M
2	Fan	Start the fan when the body temperature reaches 50 °C
3	Intercom jack	Connection to an intercom or headsets with a TA5 mini XLR connector
4	GPS Antenna	Connect an GPS antenna (Not supported on MKII)
5	Exter Speaker	Connect the external speaker

DISPLAY

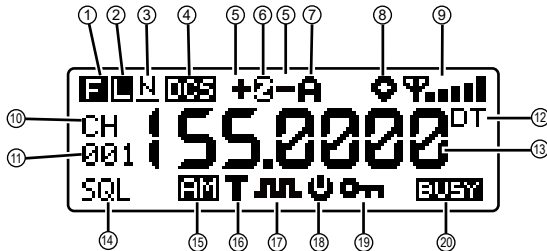

NO.	KEY	FUNCTION
1	F	Function key is activated
2	H M L S	high power, medium power, low power, ultra-low power
3	N W	Narrow Band , Wide Band
4	DCS	Set DCS function
4	TSQ	Set CTCSS function
5	+ -	Offset frequency direction
6	S	Scramble (Not supported on TMKII and EMKII)
7	A	Scan
8	GPS	GPS (Not supported on MKII)
9	Signal strength	Signal strength
	Prohibition of firing	Prohibition of firing indication
10	CH	Display this icon when in memory mode
11	001	Indicates the channel number in memory mode
12	DT	Optional signaling type
13	145.2255	Indicate the frequency value or remember the channel name
14	SQL	The noise reduction level is set
15	FM	FM radio is enabled
15	AM	AM radio is enabled (Not supported on MKII)
16	T	Off-network activation indication
16	R	Frequency reverse
17	JL	Compander
18	Auto turn off	Auto turn off
19	Keypad lock	Keypad lock
20	BUSY	Signal is being received or monitor

MICROPHONE

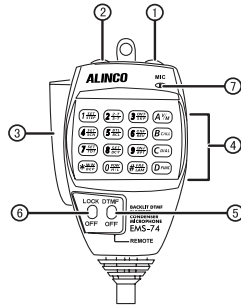

MIC Connector Diagram(in the front view of connector)

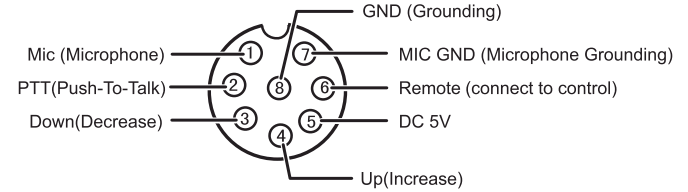

NO.	KEY	FUNCTION
1	UP	Increase frequency, channel number or setting value.
2	DOWN	Decrease frequency, channel number or setting value.
3	PTT	Push-To-Talk key to transmit.
4	Numerical Keyd	Input VFO frequencies and other various operations
5	DTMF ON/OFF	Switches between DTMF and function operations.
6	LOCK Switch	Locks all keys excep PTT.
7	MIC	Microphone element is located. * Do not cover the mic hole.

This machine can be set to either amateur or professional mode according to the user's actual usage needs. There are also two functional menus that can be used to set the desired functions separately, greatly facilitating user use and operation (menus 1 to 17 of this product are for channel settings, and menus 18 to 36 are for function settings).

1. Mode Setting:

- A. PC program software settings: By setting the "Display Mode" under the PC software, you can choose between amateur mode or professional mode, set it to Frequency or Name for amateur mode, set it to Channel for professional mode.
- B. Please refer to the display type settings on page 24 for manual settings.

2. Amateur Mode:

When setting the display type to Frequency or Name, it is in amateur mode. Press the V/M key in this mode to switch between the memory channel and the temporary channel (VFO).

- A. Frequency+Channel Number Mode: Display Type set to "FR", which means entering the frequency+channel number mode. Channel function settings and shortcut functions in this mode can allow users to temporarily use, power off or change channel, the temporary settings will be automatically cleared.

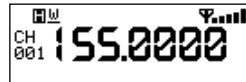

- B. Channel name mode: Set the display type of this product to 'NM', it means entering channel name mode. If the current channel has edited its name, the screen will display its corresponding name, otherwise it will display frequency+channel number. The operation of NM mode is the same as the FR mode.

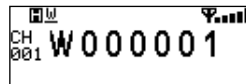

- C. Temporary Channel Mode (VFO): In this mode, function operation and channel function settings can be changed and saved until the next change. Power off or change VFO frequency doesn't change the settings. (As shown in Figure 3)

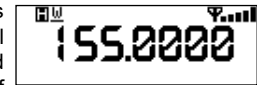

3. Professional Mode:

Set the display type to "CH", radio enters professional machine mode.

In this mode, except for scanning, other shortcut functions are restricted from operation, and function menus 1-17 are automatically hidden and must be set through PC program software.

If a channel has its corresponding personalized name edited, the screen will display its corresponding name, otherwise it will show the current channel number.

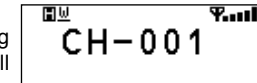
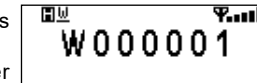

If this radio is programmed to professional mode and locked using the programming software, it will not be possible to manually return it to amateur mode through the settings in radio menu.

In any mode, menu 18-36 of the function settings can be changed and saved.

POWER ON AND OFF THE MOBILE RADIO

According to the installation method selected, press [POWER/VOL] key on radio or turn the ignition switch to ACC(acceleration) or ON (start) positions to power on radio. Hold pressing the [POWER/VOL] key for 1 second or turn the ignition switch to the OFF position will shut down the device.

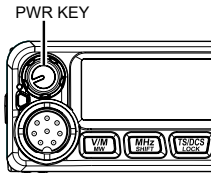

VOLUME ADJUSTMENT

Rotate [POWER/VOL] clockwise to increase the volume, rotate the POWER counterclockwise to reduce the volume.

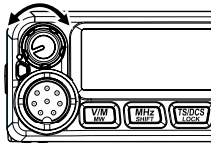

Rotate VOL (volume) during a call to adjust the desired volume more accurately.
NOTE

11

SWITCHING BETWEEN WORKING MODES

In standby mode, press the [VIM] key or the microphone button (0 key). When the CH icon is displayed on the screen, it indicates that the current channel is in channel mode. Repeat the above steps to switch between frequency mode(VF0) and channel mode.

CHANNEL SWITCH ADJUSTS FREQUENCY/CHANNEL

1. In frequency operating mode (VFO), the channel switch can be used to adjust the current frequency to the desired frequency, clockwise increases frequency, counterclockwise to decrease frequency, each adjustment can increase/decrease the frequency at one step. Press the [MHz SHIFT]

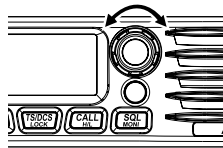

key once, the decimal part of frequency will be hidden. In this state, rotate the channel switch or press the [UP/DOWN] button on the microphone, and it will adjust the frequency quickly at 1Mhz step.

NOTE This product has nine step values available for users to choose from: 2.5K, 5K, 6.25K, 8.33K, 10K, 12.5K, 20K, 25K, 30K, and 50K.

2. In channel mode, the desired channel can be selected through the channel switch and adjusted clockwise to the next channel, adjust counterclockwise to the previous channel. In the corresponding working mode, the [UP/DOWN] keys on the microphone can also adjust the channel.

RECEIVE

When the channel you are using is called, the screen will display the BUSY icon and field strength, and you can hear the call from the transmitter.

NOTE If your mobile transceiver is set to a high mute level, you may not be able to hear the call.

If the screen of your mobile transceiver displays **BUSY** icon and field strength, but unable to hear the call from the transmitting party. It states the radio is receiving a matching carrier, but the signaling does not match (please refers to CTCSS/DCS decoding settings and optional Signal settings).

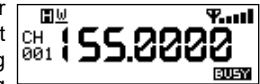

MAKE A CALL

Press and hold the [SQL MON] key or press the [*] key on the microphone to monitor for a moment and confirm that the channel you are using is not busy. At this point, release the key or press the microphone's [*] key again to return to standby mode, then hold down the [PTT] key and speak into the microphone. Please maintain a distance of approximately 2.5-5CM between the microphone and the mouth, and speak in a normal tone to achieve the best sound quality for the receiver's radio station.

 When the [PTT] key is pressed, the red LED emission indicator light will turn on and the screen will display a power intensity indicator, indicating that it is emitting. Release the [PTT] key to receive.

SEND SINGLE TONE PULSES

Press and hold the [PTT] key, then press the [DOWN] key on the microphone to send a single tone pulse signal.



SEND OPTIONAL SIGNALING

Press and hold the [PTT] key, press the [UP] key on the microphone, or directly press the  key on the panel or microphone to send prestored and selected optional signals such as DTMF, 2TONE, or 5TONE.

EDIT CHANNEL

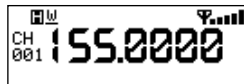

1. In frequency mode (VFO), rotate the channel switch to select the desired frequency, or the desired frequency can be entered through the numeric keypad on the microphone.

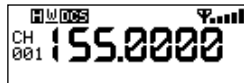

2. Press the  key to enter the CTCSS/DCS signaling settings, then turn the channel switch to select the desired signaling. Press the [F] key, and the screen will display the  icon, **CH** icon, and current channel number. When the CH icon flashes, it indicates that the current channel is empty.



3. Rotate the channel switch and select the channel number you want to store.



4. Press the  key, the  icon, **CH** icon, and channel number disappear and send a prompt sound to indicate successful channel saving.

DELETE CHANNEL

1. In channel mode, rotate the channel switch to select the channel you want to delete.
2. Press and hold the [F] key while pressing the  key, and the current channel will be deleted and a prompt sound will be emitted. The **CH** icon flashes, indicating that the current channel has been deleted.

SQUELCH OFF /TEMPORARY SQUELCH OFF

The  key can be programmed to Squelch off /temporary Squelch off, and you can use this key to listen for weaker signals.

1. Squelch off: Press the key once, the radio will not be muted, press the  key again to mute the radio.
2. Temporary Squelch off: Press and hold the key, the radio will not be muted, release the  key to mute the radio.

 **NOTE** The key function must be set in the PC program software settings.

SQUELCH LEVEL SETTING

This function is used to set the strength of the received signal. When the received signal strength reaches a certain value, the other party's call can be heard, otherwise the radio will remain silent.

1. In standby mode, hold pressing the  key and rotate the channel switch, the screen displays the **SQL** icon and the current squelch level.
2. Rotate the channel switch or press the [UP/DOWN] key to set the desired level.
3. Press any key other than POWER and FUN to exit.

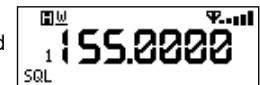

FREQUENCY/CHANNEL SCAN

FREQUENCY SCAN

In frequency mode [VFO], this function is used to monitor the signals at various communication frequency points for each step of your settings.

1. When the radio is in VFO state, press and hold the  key 1 second, frequency scanning can be performed.
2. Rotate the channel switch or press the [UP/DOWN] button on the microphone to change the scanning direction.
3. Press any key except [PWR] and [FUNC] to exit the scan.



CHANNEL SCANNING

In channel mode, this function is used to monitor the signals of various channels in this mode.

1. When the radio is in channel mode, press and hold the  key 1 second, you can enter channel scanning.
2. Rotate the channel switch or press the [UP/DOWN] button on the microphone to change the scanning direction.
3. Press any key other than [PWR] and [FUNC] to exit.

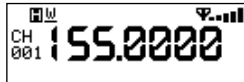

CTCSS/DCS ENCODE AND DECODE SETTINGS

Press the  keys repeatedly to set the current channel to use CTCSS/DCS encoding and decoding.

1. When the T icon is displayed on the screen, it indicates the current channel setting with

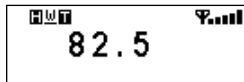

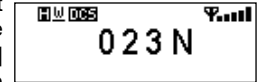
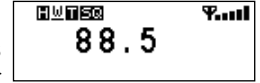

CTCSS encoding, rotate channel switch or press the [UP/DOWN] keys on the microphone to select desired CTCSS encode.

2. When the screen displays the T icon and SQ icon, it indicates that current channel is set with CTCSS encoding and CTCSS decoding, turn the channel switch or press the [UP/DOWN] button on the microphone to select the desired CTCSS decoding.
3. When the DCS icon is displayed on the screen, it indicates the current channel can synchronously set DCS encoding and decoding, rotating the channel switch or press the [UP/DOWN] button on the microphone to select the desired DCS code.
4. CTCSS:62.5--254.1, a total of 51 groups, DCS: 000N --777I, a total of 1024 groups, N states for positive codes, L states for negative code.
5. Press any key except the [FUNC], [PWR], and  keys to return to standby mode.



CTCSS SCANNING

Press the  keys repeatedly, when the screen displays the T icon and SQ icon, keep pressing the  key continuously for 1 second, it will enter CTCSS scanning mode, when a matching CTCSS is scanned, the radio pause for 15 seconds and continue scanning.

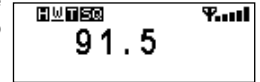

DCS SCANNING

Press the **[TS/DCS LOCK]** keys repeatedly, and when the screen displays the **DCS** icon, keep pressing the **[TS/DCS LOCK]** button continuously for 1 second, it will enter DCS scanningmode, when a matching DCS signaling is scanned, the radio pauses for 15 seconds and continue scanning.

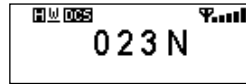

HIGH, MEDIUM, AND LOW POWER OPTIONS

Press the **[FUNC]** key to display the **[F]** icon on the screen, then press the **[CALL/HIL]** key to switch between high, medium, or low power, and the screen displays the current power status.

Display **H** icon: High power.

Display **M** icon: Medium power.

Display **L** icon: Low power.

Display **S** icon: Ultra-low power.

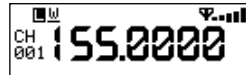
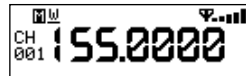
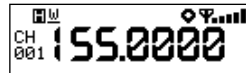

TURN ON/OFF VOICE COMPANDER FUNCTION (REDUCE NOISE, IMPROVE CALL CLARITY)

After enabling this function, it can effectively reduce call noise and improve call clarity, and have a more significant effect in long-distance communication.

1. Press **[FUNC]** key, then press the **[SQL MONI]** key to activate the voice compander function, repeat the above steps to turn off the voice



compander function.

2. When the screen displays icon, it indicates that the current channel turns on the voice compander function.
3. When the icon is not displayed on the screen, it indicates that the function is off.



OFFSET FREQUENCY DIRECTION AND SETTING

The repeater receives signals at one frequency (UP-LINK uplink) and retransmits them at another frequency (DOWN-LINK downlink).

The difference between these two frequencies is called the offset frequency, and if the frequency of the uplink is higher than the frequency of the downlink, the direction of the offset frequency is positive. On the contrary, the offset frequency direction is negative.



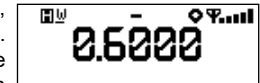
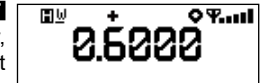

1. Press the **[FUNC]** key to display the **[F]** icon on the screen, then press **[MHZ SHIFT]** Key, the screen displays the direction and offset frequency.
2. Press the **[MHZ SHIFT]** key repeatedly to select positive or negative offset direction. When screen displays '+' icon, indicating positive offset frequency, i.e. transmission frequency is higher than the receiving frequency. When the screen displays '-' icon, indicating the negative offset frequency, which is the transmission frequency lower than the receiving frequency.
3. Turn the channel switch or press the **[UP/DOWN]** button on the microphone to change the offset frequency. The change is basing on the step frequency.
4. Press any key except the **[MHZ SHIFT]** key to return to standby mode.



In channel mode, this operation is a temporary change that allows users to temporarily use, after change the channel or restart, the temporarily changed settings will be automatically cleared.

KEYBOARD LOCK

To prevent accidental operation, this function can be used to lock the keyboard. Except for the APRS, SQL, FUN, and POWER keys, all other keys cannot be used.

1. Press the [FUNC] key to display the  icon on the screen, then press the  key, the screen displays the  icon, indicating the lock button function is valid.
2. Repeat the above operation, when the  icon disappears, it means the lock button function has been disabled.

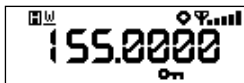

DISPLAY CURRENT VOLTAGE

This function can be used to check the voltage of the battery.

1. Press and hold [FUNC], then press the  key, and the screen will display the current voltage.
2. Repeat the above operation to return the frequency or channel display.

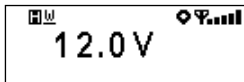

 All functional operations and channel or frequency selections are invalid when the voltage is displayed.

AUTOMATIC DIALER SETTINGS

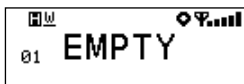

This function can quickly send pre-edited DTMF signaling, which is the same as the signaling used in telephone systems. They are often used for remote control of electronic devices or for AUTOPATCH telephone systems installed on certain repeaters.

1. Press and hold the [FUNC] key, then press the  key to enter automatic dialing to check the status of the device, and the screen displays the current group. If there is no data in the current group, it will display 'EMPTY'.



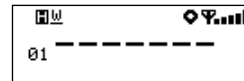

2. Rotate the channel switch to select the group you want to edit, 01-16. There are a total of 16 groups.



3. Press the  key to enter the current group editing state, and inputs the desired data on the keypad of microphone.
4. After entering the 7th digit, the displayed content will scroll and appear. You can input numerical values such as 0-9, "-", A-D * #, etc., totaling 23 digits.
5. After editing, press the [PTT] or  key to send the current group and save the edited DTMF signaling. Press the  key to exit and save.

TRANSMITTING EDITED DTMF TONES IN THE AUTO-DIALER MEMORY

1. Press and hold the [FUNC] key, then press the  key to enter the automatic dialer query mode.
2. Rotate the channel switch to select the desired group to send.
3. Press the [PTT] or  key to send the currently selected signaling.
4. Press the button to confirm the selection and exit. (If you want to edit the channel name or power on information at this time, press the VMTSDCS0 key to shift forward and backward, press the  key to save and exit.)

EMERGENCY ALARM

Activating this feature will trigger an alert.

1. Press and hold [ALARM] for more than 2 seconds to activate the alarm.
2. Press [ALARM] to cancel the alarm.

 NOTE This feature needs to be set through the PC program software.

PROGRAMMABLE [PF] KEY

The short press of program key can be assigned to the following functions through the program software:

Voltage: Short press this button to show the voltage.

FM: Turn on/off the FM radio.

AM: Turn AM on/off. (Not supported on MKII)

NR: Enable/disable RX noise reduction.

TR: Enable/disable TX noise reduction.

FAN: Set the start mode of the cooling fan.

GPS: Turn on/off GPS. (Not supported on MKII)

APRS: Turn on/off APRS. (Not supported on MKII)

Scrambler: Enable/disable scrambler function. (Not supported on TMKII/EMKII)

NR Level: Set the level of RX noise reduction, repeat pressing the button to turn off the receive noise reduction function.

APRS SENDS (NOT SUPPORTED ON MKII)

This function can send APRS message.

1. Press the [ALARM] key to initiate APRS signal transmission.
2. The signal light is on, and the device emits APRS encoded audio.
3. After the APRS signal is sent, it will automatically return to the standby interface.



NOTE When APRS PTT is turned on, pressing [PTT] will send APRS message.

APRS RECEPTION (NOT SUPPORTED ON MKII)

This function can display the information of the sender when receiving APRS message.





1. Rotate the channel switch to switch the information interface.
2. If not operated for more than 2 seconds, it will automatically return to the standby interface.

DST: 1419.5Km Course: 000 HF Gateway		25° 00.00N 119° 00.00E Alt: 44m Spd: 0Km/h HF Gateway
Path4: Temp: Hum: HF Gateway		ID: Path3: Path3: Path3: HF Gateway
Remarks: APRSCN WIFI 4.30V HF Gateway		

6

Parameter Setting Mode

MENU FUNCTION OPTIONS

1. Press and hold the [FUNC] key for more than 2 seconds to enter the function settings.
2. Press and hold the  or  key to select the desired feature option.
3. Rotate the channel switch to select the desired settings.
4. Press the  key to confirm the selection and exit. Press the  /  keys if you want to edit the channel name or power on information.





NOTE

In professional mode, the 1-18th function options will be automatically hidden. Holding down the [FUNC] key in FM radio operation mode is ineffective.

STEP FREQUENCY SETTING

17 This function is only effective in frequency mode (VFO).The frequency selection from the rotary channel switch or frequency scanning is constrained by the step frequency.

1. Press and hold the [FUNC] key for more than 2 seconds to enter the function settings.
2. Press the  or  key to select 01 option, the screen displays "STP-12.5K".
3. Rotate the channel switch to select the desired step frequency.This product has 5K, 6.25K, 8.33K,10K, 12.5K, 20K, 25K, 30K, and 50K total nine steps for optional.
4. Press the  keys to confirm the selection and exit.
Default: 12.5K

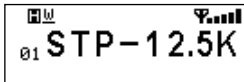

NOTE

When the radio is in memory mode, this option will automatically hide.

DTMF, 2TONE OR 5TONE SIGNALING

DTMF, 2TONE, 5TONE have similar functions to CTCSS/DCS, among which DTMF and 5TONE have special call functions, including ANT, PTTID, full call, alarm, remote stun, remote kill, wake-up, etc. For detailed instructions, please refer to the help instructions of the PC program software.

1. Press and hold the [FUNC] key for more than 2 seconds to enter the function settings.
2. Press the key to select option 02, and the screen will display 'T-OFF'.

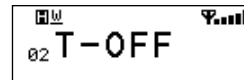

3. Rotate the channel switch to select the desired settings.

(1)When select 'DTMF', it indicates the optional signaling in current channel is DTMF, only when the received DTMF code is same as the radio's self DTMF ID, the call can be heard. Hold down the [PTT] key and then press [UP] or directly press the  key to send pre stored and selected DTMF signaling.

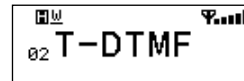



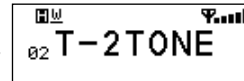
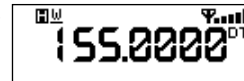

(2)When select "2TONE", it indicates the optional signaling in current channel is 2TONE,only when the received 2TONE decode is same as the radio's 2Tone encode, the call can be heard. Hold down the [PTT] key and then press [UP] or directly press the  key to send pre stored and selected 2TONE signaling.

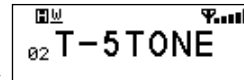

(3)When select "5TONE", it indicates the optional signaling in current channel is 5TONE, only when the received 5TONE decode is same as the radio's 5Tone ID, the call can be heard. Hold down the [PTT] key and then press [UP] or







directly press the  key to send pre stored and selected 5TONE signaling.

 **NOTE** When the optional signaling is 5TONE, hold down CALL for 2 seconds and the screen displays "AN ----". Rotate the channel switch and select the desired number (the other party's ID code). In this state, press  to confirm the current character and move the cursor to the next character. Press  to move the cursor to the previous character. After editing the other party's ID code, press the  key to make an ANI call.



4. Press the  keys to confirm the selection and exit.
Default: OF

SELECT 2TONE SIGNALING ENCODING GROUP

1. Press and hold the [FUNC] key for more than two seconds to enter the function settings.
2. Press the  or  key to select option 03, and the screen will display "2T-XXX", where "XXX" indicates the current group. Rotate the channel switch, select the 2TONE group you want to send, and press the [PTT] key to send theselected group.
3. There are 32 groups in total, 000-031, default 000.
4. Press the  keys to confirm the selection and exit.

 **NOTE** The content and name of 2TONE must be edited in the PC program software. The radio can only query the edited groups and names.If there is a corresponding name for 2TONE editing, entering this operation will display the name corresponding to 2TONE.

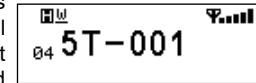

SELECT 5TONE SIGNALING CODING GROUP

1. Press and hold the [FUNC] key for more than 2 seconds to enter the function settings.
2. Press the  or  key to select option 04, and the screen will display "5T-XXX", where "XXX" indicates the current group. Rotate the channel switch, select the 5-TONE group you want to send, and press the [PTT] key to send the current selected group.
3. There are a total of 100 groups, from 000-099, with a default of 000.
4. Press the  keys to confirm the selection and exit.



 **NOTE** The content and name of 5TONE must be edited in the PC program software. The radio can only query edited groups or names. If there is a corresponding name for 5TONE editing, entering this operation will display the name corresponding to 5TONE.

SELECT DTMF SIGNALING ENCODING GROUP

1. Press and hold the [FUNC] key for more than 2 seconds to enter the function settings.
2. Press the  or  key to select option 05, and the screen will display "DTMF-XX", where "XX" indicates the current group. Rotate the channel switch, select the DTMF group you want to send, and press [PTT] to send the current selected group.
3. There are a total of 16 groups, 1-16, with a default of 1.
4. Press the  keys to confirm the selection and exit.

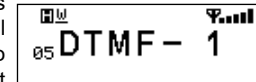

SIGNALING GROUP SETTING

This function is used to prevent receiving signals from irrelevant groups.

1. Press and hold the [FUNC] key for more than 2 seconds to enter the function settings.

2. Press the **[CALL]** or **[SQL MONI]** key to select option 06, the screen displays 'SPK -- SQ'.

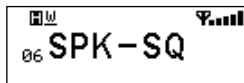

3. Rotate the channel switch and select the desired combination. When select 'SQ', you can hear the call from the transmitter as long as the radio receives matched carrier.

(1)The screen displays "CTC", indicating that you can hear the call from the transmitter when the radio receives matched carrier and matched CTCSS & DCS signaling.

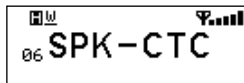

(2)The screen displays 'TON', indicating that you can hear the call from the transmitter when the radio receives matched carrier and matched DTMF signaling, 2TONE signaling or 5TONE signaling.

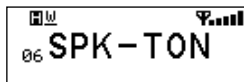

(3)The screen displays "C * T", indicating that only when the radio receives matched carrier and matched CTCSS/DCS signaling and matched DTMF/2TONE/5TONE signaling, you can hear the call from the transmitting party.

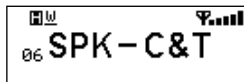

(4)The screen displays "C/T", indicating that as long as the radio receives the matched carrier and either matched CTCSS/DCS signal or matched DTMF/2TONE/5TONE signaling, you can hear the call from the transmitter.

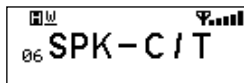

 NOTE This setting requires the addition of optional signaling and CTCSS/DCS settings to complete the setup.

HIGH AND LOW POWER SELECTION

1. Press and hold the [FUNC] key for more than 2 seconds to enter the function settings.

2. Press the **[CALL]** or **[SQL MONI]** key to select option 07, and the screen will display "POW-HI".

3. Rotate the channel switch to select the desired settings.

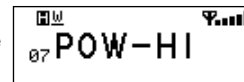

HI : The current channel will transmit at high power.

MI : The current channel will transmit at medium power.

LO : The current channel will transmit at low power.

SM : The current channel will transmit at ultra-low power.

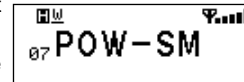
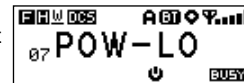
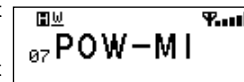

4. Press the **[TS/DCS LOCK]** keys to confirm the selection and exit.

Default: HI

WIDE AND NARROW BAND SETTINGS

Choose legal communication methods according to the regulations of each country.

1. Press and hold the [FUNC] key for more than 2 seconds to enter the function settings.

2. Press the **[CALL]** or **[SQL MONI]** key to select option 08, and the screen will display "BAND-25".

3. Rotate the channel switch to select the desired settings.

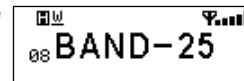

25: The bandwidth is 25K (wide band)

- 20: The bandwidth is 20K (mid band)
- 12: The bandwidth is 12.5K (narrowband)
- 4. Press the **[TS/DCS LOCK]** keys to confirm the selection and exit.
- 5. Default: 25 (wide band)

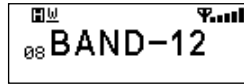
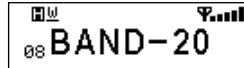

PROHIBITED TRANSMISSION SETTING

After this function is turned off, pressing the [PTT] key is ineffective, and the current channel can only operate in receiving mode.

1. Press and hold the [FUNC] key for more than 2 seconds to enter the function settings.
2. Press the **[CALL HIL]** or **[SQL MONI]** key to select option 09, and the screen will display "TX-ON".
3. Rotate the channel switch to select the desired settings.

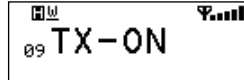

ON: Press the [PTT] key to transmit normally;

OFF: Pressing the [PTT] key is invalid

4. Press the **[TS/DCS LOCK]** keys to confirm the selection and exit.
5. **Default:** ON

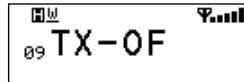

BUSY CHANNEL LOCK SETTING

After enabling this function, it cannot transmit on busy channels, which can prevent interference with walkie talkies that are using the same frequency as you. If the current channel is busy, press [PTT] button, the radio emits an error prompt sound and returns to receive status.

1. Press and hold the [FUNC] key for more than 2 seconds to enter the function settings.
2. Press the **[CALL HIL]** or **[SQL MONI]** key to select option 10, the screen displays 'LOCK OF'.
3. Rotate the channel switch to select the desired settings.

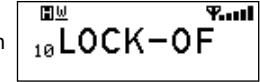

BU: Enable channel busy lock function, in this state, when the radio receives a matching carrier, transmission is prohibited. Press the [PTT] key to emit an error prompt sound and return to the receive state.

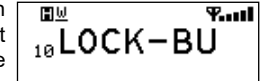

RL: Enable signaling busy lock function, in this state, when the radio receives a matching signal but unmatched CTCSS/DCS signaling, the transmission is prohibited. Press the [PTT] key to send an error prompt sound and return to the receiving state.

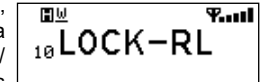

OFF: Disable the busy channel lock function. In this state, regardless of the receiving status, the transmission is allowed.

4. Press the **[TS/DCS LOCK]** keys to confirm the selection and exit.



In VFO mode, this option function will be automatically hidden.

CHANNEL NAME EDITING SETTINGS

1. Press and hold the [FUNC] key for more than two seconds to enter the function settings.
2. Press the **[CALL HIL]** or **[SQL MONI]** key to select option 11, the screen displays a cursor and flashes.
3. Rotate the channel switch to select the desired character, and press the TS/DCS keys to confirm the current character and enter the next

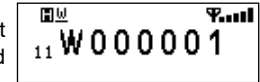

character for editing, press **[V/M]** to return to the editing status of the previous character.

- After editing is complete, press the **[MHZ SHIFT]** key to exit.

■ FREQUENCY REVERSE

By enabling this function, the transmission and reception frequencies will be exchanged, that is, the transmission frequency will become the reception frequency, and the reception frequency will become the transmission frequency. If CTCSS/DCS signaling is set for the channel, the CTCSS/DCS encoding and decoding will also be exchanged with each other.

- Press and hold the [FUNC] key for more than 2 seconds to enter the function settings.
- Press the **[CALL HL]** or **[SQL MONI]** key to select option 12, and the screen will display "REV-OF".

- Rotate the channel switch to select the desired settings.

ON: Enable frequency reversal function

OFF: Cancel frequency reversal function

- After editing is complete, press the TS/DCS key to exit.

Default: OF

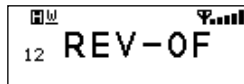

■ TALK AROUND FUNCTION

Enabling this feature will disconnect the radio from communication with the repeater. The frequency and CTCSS/DCS signaling transmission in this state are the same as the received frequency and CTCSS/DCS.

- Press and hold the [FUNC] key for more than 2 seconds to enter the function settings.
- Press the **[CALL HL]** or **[SQL MONI]** key to select option 13, and the screen will

display **TALK-OF**.

- Rotate the channel switch to select the desired settings.

ON: Enable the repeater disconnection function.

OFF: Disable the repeater disconnection function.

- After editing is complete, press the **[TS/DCS LOCK]** key to exit.

Default: OF

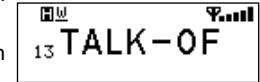
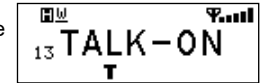

■ VOICE COMPANDER FUNCTION (REDUCES NOISE, IMPROVES CALL CLARITY)

After enabling this function, it can effectively reduce noise and improve call clarity, and the effect is more significant in long-distance communication.

- Press and hold the FUNC key for more than 2 seconds to enter the function settings.
- Press the **[CALL HL]** or **[SQL MONI]** key to select option 14, and the screen will display **COMP-OF**.

- Rotate the channel switch to select the desired settings.

ON: Enable voice compander function

OFF: Disable voice compander function

- Press the **[TS/DCS LOCK]** keys to confirm the selection and exit.

Default: OF

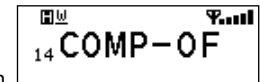

VOICE ENCRYPTION SETTINGS (TO PREVENT THEFT)

This function is a special voice processing method that allows the other walkie talkies using the same frequency to only hear chaotic voice and unable to hear correct conversations, achieving effective confidentiality.

1. Press and hold the [FUNC] key for more than 2 seconds to enter the function settings.
2. Press the **[CALL HL]** or **[SQL MONI]** key to select the 15th function option, and the screen will display "SCR-ON".
3. Rotate the channel switch to select the desired settings.
ON: Enable voice encryption
OFF: Turn off voice encryption
4. Press the **[TS/DCS LOCK]** keys to confirm the selection and exit.

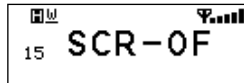
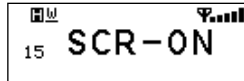

Default: OF

This feature is an optional item.(not compatible with DRB185TMK2 and NOTE DRB185EMK2)

APRS RECEIVING FUNCTION SWITCH SETTING

After this feature is enabled, it can receive other APRS requests. Upon receiving APRS, it will switch to the other party's APRS information display.

1. Press and hold the [FUNC] key for more than 2 seconds to enter the function settings.
2. Press the **[CALL HL]** or **[SQL MONI]** key to select the 16th function option, and the screen will display "APRSRXOF".
3. Rotate the channel switch to select the desired settings.



ON: Activate APRS RX

OF: Turn off APRS RX

4. Press the **[TS/DCS LOCK]** keys to confirm the selection and exit.

Default: OF

LOCAL DTMF ID QUERY

1. Press and hold the [FUNC] key for more than 2 seconds to enter the function settings;
2. Press the **[CALL HL]** or **[SQL MONI]** key to select function 17 Option, the screen displays "D-XXX", "XXX" is the DTMFID code of this radio itself.
3. Press the **[TS/DCS LOCK]** keys to confirm the selection and exit.

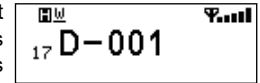

LOCAL 5-TONE ID QUERY

1. Press and hold the [FUNC] key for more than 2 seconds to enter the function settings
2. Press the **[CALL HL]** or **[SQL MONI]** key to select the 18th function selection item, the screen displays "F-XXXXX", "XXXXX" is the 5-TONE ID code of this radio.
3. Press the **[TS/DCS LOCK]** keys to confirm the selection and exit.

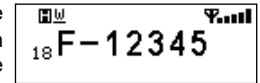

PROMPT SOUND SETTING

The prompt sound function is to confirm the operation prompt, error or fault status of this product. This product sets the prompt sound function to be turned on or off.

1. Press and hold the [FUNC] key for more than 2 seconds to enter the function settings.

6

Parameter Setting Mode

2. Press the **CALL** or **SQL** key to select option 19, and the screen will display **BEEP-ON**.



3. Rotate the channel switch to select the desired settings;

ON: Sound prompt activated

OFF: The prompt sound is turned off



4. Press the **TS/DCS** keys to confirm the selection and exit.

Default: ON.

NOTE It is recommended to enable this feature to detect erroneous operations and fault states.

TIME-OUT TIMER SETTING

The timeout timer function is designed to limit the continuous long-term transmission of this product. When the continuous transmission of this product exceeds the predetermined time, it will be forcibly interrupted and a prompt sound will be emitted.

1. Press and hold the [FUNC] key for more than 2 seconds to enter the function settings.

2. Press the **CALL** or **SQL** key to select option 20, and the screen will display "TOT-3".

3. Rotate the channel switch to select the desired settings; 1-30: A total of 30 minutes of timed options are available, with a 1-minute interval between each level.

OFF: Turn off the timeout timer.

4. Press the **TS/DCS** keys to confirm the selection and exit.

Default: 3.

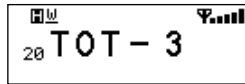

APD (AUTO POWER OFF)

After enabling this function, the product will automatically turn off the power after reaches the scheduled time of operation.

1. Press and hold the [FUNC] key for more than 2 seconds to enter the function settings.

2. Press the **CALL** or **SQL** key to select option 21, and the screen will display "APO-OFF".

3. Rotate the channel switch to select the desired settings.

30MIN: Automatic shutdown after 30 minutes

1HOUR: Automatic shutdown after 1 hour

2HOUR: Automatic shutdown after 2 hours

OFF: Turn off the automatic shutdown function

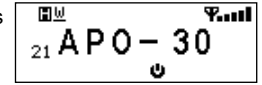

4. Press the **TS/DCS** keys to confirm the selection and exit.

Default: OF.

DTMF TRANSMISSION TIME SETTING

1. Press and hold the [FUNC] key for more than 2 seconds to enter the function settings.

2. Press the **CALL** or **SQL** key to select the 22nd function selection, the screen displays "SPD-50".

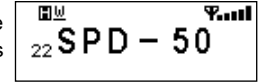

3. Rotate the channel switch to select the desired settings;

30: Each audio signal of DTMF signaling is sent for 30ms and stopped for 30ms

50: Each audio signal of DTMF signaling is sent for 50ms and stopped for 50ms

100: Each audio signal of DTMF signaling is sent for 100ms and

stopped for 100ms

200: Each audio signal of DTMF signaling is sent for 200ms and stopped for 200ms

300: Each audio signal of DTMF signaling sends 300ms and stops for 300ms

500: Each audio signal of DTMF signaling sends 500ms and stops for 500ms

4. Press the **[TS/DCS LOCK]** keys to confirm the selection and exit.

Default: 50ms

■ SQUELCH LEVEL SETTING

This function is used to set the strength of the received signal. When the received signal strength reaches a certain value, the other party's call can be heard, otherwise the walkie talkie will remain silent.

1. Press and hold the [FUNC] key for more than 2 seconds to enter the function settings.

2. Press the **[CALL/RL]** or **[SQL/MONI]** key to select option 23, and the screen will display "SQL-04".

3. Rotate the channel switch to select the desired level of noise reduction. OF-20 has a total of 21 levels, with OF being the lowest set value (normally open)

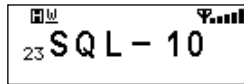

4. Press the **[TS/DCS LOCK]** keys to confirm the selection and exit.

Default: 04

Tip: Hold down the **[SQL/MONI]** key and rotate the channel switch to select the desired squelch level.



Excessive squelch level may prevent this product from effectively receiving strong signals. A low squelch level may cause external interference to this product.

■ SCAN PAUSE TIME SETTING

This product has three scanning pause modes for users to set.

1. Press and hold the [FUNC] key for more than 2 seconds to enter the function settings.

2. Press the **[CALL/RL]** or **[SQL/MONI]** key to select the 24th function selection, the screen displays "SCAN-TO".

3. When rotating the channel switch to select the desired scan pause time.

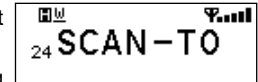

TO: Pause for 5 seconds after scanning a matching signal, and then continue scanning.

CO: Pause scanning when a matching signal is detected, continue scanning after the signal disappears

SE: Stop scanning after detecting a matching signal

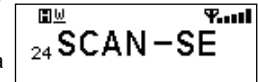
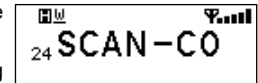

4. Press the **[TS/DCS LOCK]** keys to confirm the selection and exit.

Default: TO

■ BACKLIGHT BRIGHTNESS SELECTION SETTING

1. Press and hold the [FUNC] key for more than 2 seconds to enter the function settings.

2. Press the **[CALL/RL]** or **[SQL/MONI]** key to select option 25, and the screen will display "LAMP-25".

3. Rotate the channel switch to select the desired backlight brightness. There are a total of 32 levels of backlight brightness available for selection, ranging from 1 to 32.

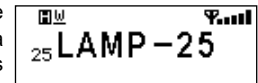

4. Press the **[TS/DCS LOCK]** keys to confirm the selection and exit.

Default: 25

PILOT FREQUENCY SELECTION

This function is used to wake up a dormant repeater, which requires a certain strength of pilot to be awakened. Usually, as long as the repeater is awakened, there is no need to send another pilot.

1. Press and hold the [FUNC] key for more than 2 seconds to enter the function settings.
2. Press the **CALL** or **SQ** key to select option 26, the screen displays "TB-1750".

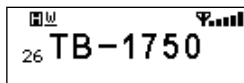

3. Rotate the channel switch to select the desired pilot frequency.

1750: The pilot frequency is 1750Hz

2100: The pilot frequency: 2100Hz

1000: The pilot frequency is 1000Hz

1450: The pilot frequency is 1450Hz

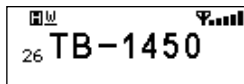
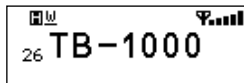
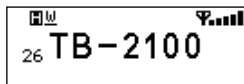

4. Press the **TS/DCS** keys to confirm the selection and exit.

Default: 1750Hz

DISPLAY TYPE SETTINGS

This product has three display modes to choose from: frequency+channel number, channel number and channel name+channel number.

1. Press and hold the [FUNC] key for more than 2 seconds to enter the function settings.
2. Press the **CALL** or **SQ** key to select the 27th function selection, the screen displays "DSP FR".

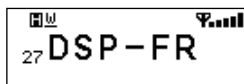

3. Rotate the channel switch to select the desired display type.

FR: Frequency+Channel Number Display Mode (Amateur Mode)

CH: Channel number display mode (professional mode)

NM: Channel name+channel number display mode, the radio will display frequency+channel number when the channel is unnamed, otherwise display its name. (Amateur mode)

4. Press the **TS/DCS** keys to confirm the selection and exit.

Default: FR

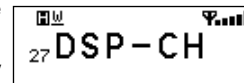

If the channel mode is locked, this option will be automatically hidden.
NOTE (Refer to the settings of the PC program software).

ENABLE/DISABLE PASSWORD FUNCTION

After this function is enabled, a matching password must be entered to enter normal working mode when starting up (the password must be set through the PC program software).

1. Press and hold the [FUNC] key for more than 2 seconds to enter the function settings.
2. Press the **CALL** or **SQ** key to select option 28, and the screen will display "CODE-OF".

3. Rotate the channel switch to enable/disable password function.

ON: Enable password function

OFF: Cancel password function

4. Press the **TS/DCS** keys to confirm the selection and exit.

Default: OF

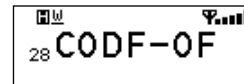
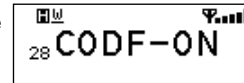

ADDRESS BOOK SETTINGS

After entering the desired ID and its corresponding name in the address book. When an ANI call is received and the ID matches a certain ID in the address book, the screen will display the name corresponding to that ID.

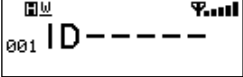
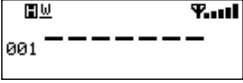
1. Press and hold the [FUNC] key for more than 2 seconds to enter the function settings; 
2. Press the [CALL HL] or [SQL MONI] key to select option 29, the screen displays 'BOOK'. 
3. Press the [MHZ SHIFT] key to enter ID settings, press the [CALL HL] or [SQL MONI] key to select the group (00-127, a total of 128 IDs can be edited. Rotating channel switch to select the desired number, press the [TS/DCS LOCK] key to confirm and enter the next number for editing, press the [V/M MW] key to clear all numbers in the current state. 
4. After completing the ID editing, press [MHZ SHIFT] to confirm and enter the current group edit mode for the name editing, rotating the channel switch to select desired character, press the [TS/DCS LOCK] key to confirm and enter the next character editing and press the [V/M MW] key to clear all characters in the current state.
5. Press the [MHZ SHIFT] key to confirm and return to the main menu, repeat step 3 and 4 to edit multiple IDs and their corresponding name.
6. Press the [TS/DCS LOCK] keys to confirm the selection and exit.

NOISE REDUCTION FOR RX AUDIO

Enabling this feature can reduce noise during calls and improve call clarity.

1. Press and hold the [FUNC] key for more than 2 seconds to enter the function settings.
2. Press the [CALL HL] or [SQL MONI] key to select option 

30, and the screen will display "NR 1".

3. Rotate the channel switch to select the desired level of noise reduction.

OF: Turn off RX noise reduction

1-5: There are a total of 5 noise reduction levels to choose from

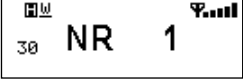
4. Press the [MHZ SHIFT] key to confirm the selection and exit. 

Default: 1

NOISE REDUCTION FOR TX AUDIO

Enabling this feature can reduce background noise and improve call clarity.

1. Press and hold the [FUNC] key for more than 2 seconds to enter the function settings.
2. Press the [CALL HL] or [SQL MONI] key to select option 31, and the screen will display "NT 1". 26

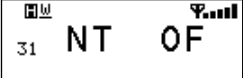
3. Rotate the channel switch to select the desired level of noise reduction. 

OF: Disable NR noise reduction function

1-5: Enable the TX noise reduction and select the level



4. Press the [MHZ SHIFT] key to confirm the selection and exit. 

Default: 1

 If the other party has enabled high-level RX noise reduction, it is not recommended to enable this function as it may cause the sound tone to change.

FAN SWITCH

After this function is enabled, the cooling fan at the back end of the radio starts, reducing the operating temperature of the radio.

1. Press and hold the [FUNC] key for more than 2 seconds to enter the function settings.
2. Press the  or  key to select option 32, and the screen will display "FAN TEM".
3. Rotate the channel switch to select the desired operation.

TEM: Start the fan when the body temperature reaches 50 °C



ON: Turn on the fan permanently regardless of the body temperature

4. Press the  key to confirm the selection and exit.

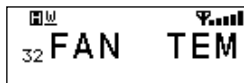
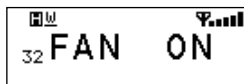
Default: TEM





FM SWITCH

1. Press and hold the [FUNC] key for more than 2 seconds to enter the function settings.
2. Press the  or  key to select option 33, and the screen will display "FM ON".
3. Rotate the channel switch to select ON/OFF FM.
4. Press the  key to confirm the selection.



 For FM VFO frequency setting, channel saving, and VFO/MR switching, please refer to the channel related operations on pages 12 and 13.

AM SWITCH (NOT SUPPORTED ON MKII)



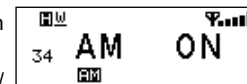

1. Press and hold the [FUNC] key for more than 2 seconds to enter the function settings.
2. Press the  or  key to select option 33, and the screen will display "AM ON".
3. Rotate the channel switch to select ON/OFF AM.
4. Press the  key to confirm the selection.



 For the VFO frequency setting in AM, channel saving, and VFO/MR switching, please refer to the channel related operations on pages 12 and 13.

GPS SWITCH (NOT SUPPORTED ON MKII)

After this function is enabled, the GPS icon flashes to indicate that pairing is in progress, and the GPS icon stops flashing and remains displayed to indicate successful pairing.

1. Press and hold the [FUNC] key for more than 2 seconds to enter the function settings.
2. Press the  or  key to select option 36, and the screen will display "GPS OF".
3. Rotate the channel switch to select the GPS switch.
ON: Enable GPS
OF: Turn off GPS
4. Press the  key to check the GPS information after GPS pairing is successful.
5. Rotate the channel switch to switch GPS information.
6. Press the  key to switch to the time zone setting.

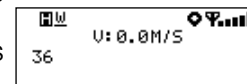

- Rotate the channel switch to switch the time zone setting.
- Press **[MHZ SHIFT]** to confirm the selection.

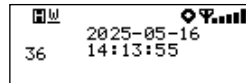
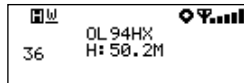
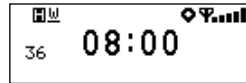

■ APRS PTT SETTING (NOT SUPPORTED ON MKII)

- Press and hold the [FUNC] key for more than 2 seconds to enter the function settings.
- Press the **[CALL]** or **[SQL MONI]** key to select option 37, and the screen will display "APRS OF".
- Rotate the channel switch to select the APRS switch.
ON: Activate APRS
OF: Close APRS
- Press **[MHZ SHIFT]** to enter the APRS menu.
- Press the CALL or SQL key to select the APRS PTT function option, and the screen will display "PTT OFF".
- Rotate the channel switch to select PTT setting.
PTT OFF: Press PTT, not send APRS information
PTT END: Press PTT, send APRS message after release PTT
PTT BOT: Press PTT, send APRS message after pressing down the PTT
- Press **[MHZ SHIFT]** to return to the main menu, or press [FUNC] to return to the standby interface.



■ APRS POWER SETTING (NOT SUPPORTED ON MKII)

- Press and hold the [FUNC] key for more than 2 seconds to enter the function settings.
- Press the **[CALL]** or **[SQL MONI]** key to select option 37, and the screen will display "APRS OF".
- Rotate the channel switch to select the APRS switch.
ON: Activate APRS
OF: Close APRS
- Press MHZ to enter the APRS menu.
- Press the CALL or SQL key to select the APRS POWER function option, and the screen will display "POW HI".
- Rotate the channel switch to select the APRS POWER option.
POW HI: High Power
POW MI: Medium Power
POW LO: Low Power
POW SM: Ultra Low Power
- Press **[MHZ SHIFT]** to return to the main menu or press [FUNC] to return to the standby interface.

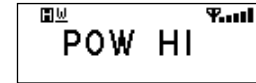

■ APRS BANDWIDTH SETTING (NOT SUPPORTED ON MKII)

- Press and hold the [FUNC] key for more than 2 seconds to enter the function settings.
- Press the **[CALL]** or **[SQL MONI]** key to select option 37, and the screen will display "APRS OF".
- Rotate the channel switch to select the APRS switch.
ON: Activate APRS
OF: Close APRS
- Press **[MHZ SHIFT]** to enter the APRS menu.

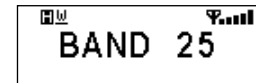

- Press the **CALL** or **SQL** key to select the APRS BAND function option, and the screen will display "**BAND 25**".
- Rotate the channel switch to select the APRS BAND option.
BAND 25: Current channel bandwidth (wide band)
BAND 20: Current channel bandwidth (mid band)
BAND 12: Current channel bandwidth (narrowband)
- Press **MHZ** to return to the main menu or press [FUNC] to return to the standby interface.

■ APRS FREQUENCY SETTING (NOT SUPPORTED ON MKII)

- Press and hold the [FUNC] key for more than 2 seconds to enter the function settings.
- Press the **CALL** or **SQL** key to select option 37, and the screen will display "**APRS OF**".
- Rotate the channel switch to select the APRS switch.
ON: Activate APRS
OF: Close APRS
- Press **MHZ** to enter the APRS menu.
- Press the **CALL** or **SQL** key to select the APRS BAND function option, and the screen will display "**FREQ 1**".
- Rotate the channel switch to select the APRS TIME option, with 8 FREQs to choose from.
- Press the **MHZ** key to return to the main menu or press the [FUNC] key to return to the standby interface.



■ APRS TEXT SETTINGS (NOT SUPPORTED ON MKII)

- Press and hold the [FUNC] key for more than 2 seconds to enter the function settings.
- Press the **CALL** or **SQL** key to select option 37, and the screen will display "**APRS OF**".
- Rotate the channel switch to select the APRS switch.
ON: Activate APRS
OF: Close APRS
- Press **MHZ** to enter the APRS menu.
- Press the **CALL** or **SQL** key to select the APRS TEXT function option, and the screen will display "**TEXT**".
- Press the **MHZ** key to enter the text settings interface.
- Rotate the channel switch to select characters.
- Press the **CALL** or **SQL** key to move the cursor. The total number of characters in the text is 21, with 8 characters frequently displayed, the remaining characters are flowing displayed.
- Press the **MHZ** key to save and return to the main menu/press the [FUNC] key to return to the standby interface.

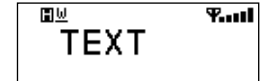

■ APRS PATH SETTING (NOT SUPPORTED ON MKII)

- Press and hold the [FUNC] key for more than 2 seconds to enter the function settings.
- Press the **CALL** or **SQL** key to select option 37, and the screen will display "**APRS OF**".
- Rotate the channel switch to select the APRS switch.
ON: Activate APRS
OF: Close APRS
- Press **MHZ** to enter the APRS menu.

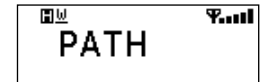

- Press the **[CALL]** or **[SQL MONI]** key to select the APRS TEXT function option, and the screen will display "PATH".
- Press the **[MHZ SHIFT]** key to enter the text settings interface.
- Rotate the channel switch to select characters.
- Press the **[CALL]** or **[SQL MONI]** key to move the cursor. The total number of characters in the text is 21, with 8 characters frequently displayed, the remaining characters are flowing displayed.
- Press the **[MHZ]** key to save and return to the main menu/press the [FUNC] key to return to the standby interface.

■ APRS INTERVAL SETTING (NOT SUPPORTED ON MKII)

- Press and hold the [FUNC] key for more than 2 seconds to enter the function settings.
- Press the **[CALL]** or **[SQL MONI]** key to select option 37, and the screen will display "APRS OF".
- Rotate the channel switch to select the APRS switch.

ON: Activate APRS

OF: Close APRS

- Press MHZ to enter the APRS menu.
- Press the **[CALL]** or **[SQL MONI]** key to select the APRS INTERVAL function option, and the screen will display "INTERVAL".
- Press the **[MHZ SHIFT]** key to enter the APRS INTERVAL function options interface.

- Rotating channel switch selection function options.

OFF: Turn off automatic resend

30S~7650S: Automatic resend with interval setting time, 30S is the step.

- Press **[MHZ SHIFT]** key to save and return to main

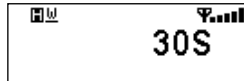
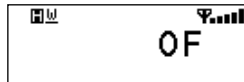
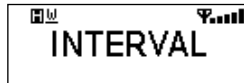

menu/press [FUNC] key to return to standby interface.

■ APRS BEACON SETTINGS (NOT SUPPORTED ON MKII)

- Press and hold the [FUNC] key for more than 2 seconds to enter the function settings.
- Press the **[CALL]** or **[SQL MONI]** key to select option 37, and the screen will display "APRS OF".
- Rotate the channel switch to select the APRS switch.

ON: Activate APRS

OF: Close APRS

- Press **[MHZ SHIFT]** to enter the APRS menu. Press the **[CALL]** or **[SQL MONI]** key to select the APRS BEACON function option, the screen displays 'BEACON'.

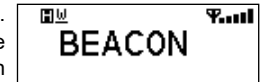

- Press the **[MHZ SHIFT]** key to enter the APRS BEACON function options interface.
- Rotating channel switch selection function options.

GPS: Sending GPS location information

FIX1~FIX8: Send custom position information

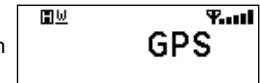

- Press the **[MHZ SHIFT]** key to save and return to the main menu/press the [FUNC] key to return to the standby interface.



NOTE The content of FIX options can only be set through PC program software.

RESTORE FACTORY SETTINGS

If the product cannot be used normally due to misoperation or setting errors, this function can be used to restore all the setting channels of the product to their factory state.

1. Press and hold the [FUNC] key for more than 2 seconds to enter the function settings.

2. Press the **CALL** or **SOL** key to select the 38th function option, and the screen will display "RESTORE".

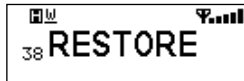

3. Rotate the channel switch to select the desired operation.

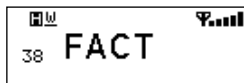

FACT: Restore the channels, signaling, and all functions to factory settings.



SETUP: Restore the 18th to 27th functions to factory settings.



4. Press the **MHZ** key to confirm the selection.

* In this chapter, operations shown with  is available to all units,  is subject to dealer-programming or restrictions. Some of features may be functional in memory mode temporary, but the setting will return to the initial parameters after changing channel or turned off the unit.

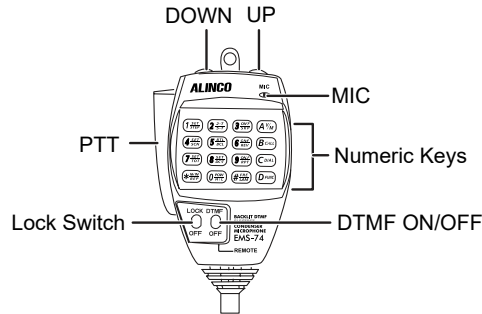

You can operate the transceiver by keypad or input desired frequency or channel through the EMS-74 microphone. Keypad operations may be blocked for dealer-programmed units.

KEYPAD LOCK

Pull down the slide switch to lock position, The lamp is turned off and all of keypads is not work except PTT switch.



TRANSMITTING DTMF BY MICROPHONE KEYPAD

Slide DTMF key to DTMF position, press and hold the [PTT] key, transmitting the desired DTMF signaling by the numeric key directly.





NOTE The keypad operation is suspended in DTMF position.

FUNCTION SETUP BY MICROPHONE KEYPAD

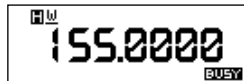
Squelch off: In standby, press  key, the squelch is disabled when  icon







flashed in LCD, Press  again to enable squelch and the  icon disappears.

SWITCHES BETWEEN VFO AND CHANNEL MODE

In standby, press  key to switch between channel mode and Frequency mode (VFO).

SHORT CALLING





Press PTT switch and  key to transmit the selected DTMF/2TONE /5TONE in current channel.

Transmitting DTMF Code: In standby, press , LCD displays DTMF data and group. Press [ / ] key to select the desired transmitting DTMF group, then Press PTT to transmit.



If no DTMF data in current group, LCD displays "EMPTY", press  key again and input desired DTMF code by keypad, press PTT to transmit and store DTMF data.

FREQUENCY STEP

Only in VFO mode, this function is valid.

1. Press , then press , LCD displays "STP--125".
2. Press  /  to select the desired frequency channel step.
3. Press any numeric keys to save and exit.

OPTIONAL SIGNALING

In standby, press , then press  to add optional signaling, repeat above operation to set DTMF, 2TONE or 5TONE signaling.

DT: DTMF

2T: 2Tone

5T: 5-tone

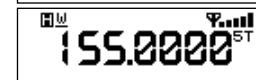
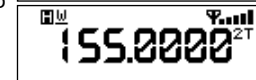
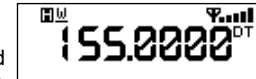



This function can be temporarily used in channel mode. Once the radio is turned off or switched to another channel, the temporary setting will be erased and back to initial settings.

☐ SCAN SKIP

In Channel mode, press **[D FUNC]** then press **[3 SCAN SKIP]**, the "A" icon at top of the screen disappears, the current channel will be excluded from the scan list. Repeat pressing the button to add the channel into scan list and display "A" icon at top of the screen.

■ FREQUENCY/CHANNEL SCAN

In corresponding mode, press **[D FUNC]** then press **[4 FREQ]** key to start scanning.

In scanning mode, press **[UP]** / **[DOWN]** to change scan direction.

Press [PTT] to stop scanning.

☐ BUSY CHANNEL LOCKOUT

BCL is to disable transmitting while RX signal is received. Once the channel is busy and you press PTT, the radio will beep as warning and get back to receiving.

1. In standby, press **[D FUNC]**, then press **[5 BCL BCT]** to enter into Busy Channel Lockout.

2. Press **[UP]** / **[DOWN]** to select the desired value.

BU: Enable BCL, Carrier lockout, transmitting is inhibited when current channel receives a matching carrier; press [PTT] to emit error voice prompt.

RL: Enable BTLO, transmitting is inhibited when current channel receives a matching carrier but dis-matching CTCSS/DCS. Press [PTT] to emit error voice prompt It can transmit in any receiving status.

OFF: Busy channel lockout is disabled.

3. Press number keys to confirm and exit.

☐ REVERSE TX/RX

TX frequency turns to RX frequency & RX frequency changes to TX frequency. The signaling will also be reversed if CTCSS/DCS signaling exited in this channel.

1. In standby, press **[D FUNC]**, then press **[6 REV]**, LCD displays "REV-OF".

2. Press **[UP]** / **[DOWN]** to select the desired value.

ON:Enable Frequency Reverse

OFF:Disable Frequency Reverse

3. Press number keys to confirm and exit.



☐ TOT (TIME-OUT TIMER)

The time-out timer limits the amount of transmitting time. When you reach the time limit which has been programmed by your dealer, your transmission will be cut off. In order to transmit again, you must release PTT button to reset the timer.

1. In standby, press **[D FUNC]**, then press **[7 TOT]** LCD displays "TOT-X".

2. Press **[UP]** / **[DOWN]** to select the desired value.

3. Press number key to confirm and exit.

☐ CTCSS/DCS ENCODE AND DECODE

1. In standby, press **[D FUNC]**, then press **[8 SET]** to enter into CTCSS/DCS Encode and Decode.

2. Repeat above operation to set as below:

- ▼ LCD displays **T** icon, it indicates CTCSS encode set in current channel.
- ▼ LCD displays **T** and **SO** icon, it indicates CTCSS encode and decode set in current channel.
- ▼ LCD displays **DCS** icon, it indicates DCS encode and decode set in current channel.

3. In corresponding icon, press [**UP** / **DOWN**] to select the desired CTCSS/DCS encode and decode.

4. Press **SEND**, **A/M**, or **C/DIAL** to confirm and exit.

□ TALK AROUND

By Talk Around function, you can directly communicate with other radios in your group in case the repeater is not activated or when you are out of the repeater range. The transceiver will transmit by RX frequency with its CTCSS/DCS signaling.

1. In standby, press **D FUNC**, then press **9 OFF** key, LCD displays "TALK--OF".
2. Press [**UP** / **DOWN**] to select the desired setting .

ON:Enable Talk Around

OFF:Disable Talk Around

3. Press number key to confirm and exit.

□ BEEP SOUND

The prompting tone provides confirmation of entry, error status or malfunctions of the transceiver. You can enable or disable this function.

1. In standby, press **D FUNC**, then press **SEND**, LCD displays "BEEP--XX".
2. Press [**UP** / **DOWN**] to turn on/off BEEP prompt.

BEEP—OF: turn off the beep;

BEEP—ON: turn on the beep.

3. Press number key to confirm and exit.

□ HIGH/MID/LOW POWER SELECTION

1. In standby, press **D FUNC**, then press **0 PWR**, LCD displays "POW-XX".
2. Press [**UP** / **DOWN**] to select the desired power.

HI:High Power

MI:Middle Power

LOW:Low Power

3. Press number key to confirm and exit.

□ LCD BACKLIGHT

1. In standby status, press **D FUNC**, then press **# FIRE** LCD displays "LAMP-XX" .
2. Press [**UP** / **DOWN**] to select desired backlight brightness(1-32 levels).
3. Press number key to confirm and exit.

DEFAULT SETTING AFTER RESETTING DR-B185MK II

	DR-B185MKII	DR-B185TMKII	DR-B185EMKII
VFO Frequency	155.000MHz	145.000Mhz	145.000Mhz
Memory Channels 0-199	—	CH0	CH0
Offset direction	—	—	—
Offset frequency	600KHz	600kHz	600kHz
Channel step	12.5KHz	5kHz	12.5kHz
CTCSS encode and decode	—	—	—
CTCSS frequency	88.5Hz	88.5Hz	88.5Hz
DCS encode and decode	—	—	—
DCS Code	023N	023N	023N
Output power	High	High	High
Key-lock setting	Off	Off	Off
TOT	3	Off	Off
APO	Off	Off	Off
LCD color	Orange	Orange	Orange

Optional functions will be basically deactivated and programmed values are erased.

FREQUENCY COVERAGE

	DR-B185MKII	DR-B185TMKII	DR-B185EMKII
RX	136-174MHz	136-174MHz	136-174MHz
TX	136-174MHz	144-147.9975MHz	144-145.9975MHz

TROUBLE SHOOTING

Problem	Possible Causes and Potential Solutions
(a) Power is on, nothing appears on Display.	+ and - polarities of power connection are reversed. Connect red lead to plus terminal and black lead to minus terminal of DC power supply.
(b) Fuse is blown.	Check and solve problem resulting in blown fuse and replace fuse with a new one.
(c) Display is too dim.	Set the LCD backlight parameter properly.
(d) No sound comes from speaker.	<ul style="list-style-type: none"> Squelch level too high. Decrease squelch level. Selective-calling like TSQ activated. Press [Moni] key to monitor.
(e) Key and Dial do not function.	Key-lock function is activated. Cancel Key-lock function.
(i) Rotating Dial will not change memory channel.	Transceiver is in CALL mode. Press  .
(g) PTT key is pressed but doesn't transmit.	<ul style="list-style-type: none"> Microphone connection is poor. Connect microphone properly. Antenna connection is poor. Connect antenna properly.

Please contact your dealer when a technical assistanc may be necessary.

Specifications For DR-B185MKII

9

General

Frequency Range	VHF: 136-174MHz FM: 76MHz~108MHz RX only
Number of Channels	200 channels
Channel Spacing	25KHz (Wide Band) 20KHz (Middle Band) 12.5KHz (Narrow band)
Channel step	2.5KHz, 5KHz, 6.25KHz, 8.33KHz, 10KHz, 12.5KHz, 15KHz, 20KHz, 25KHz, 30KHz, 50KHz
Operating Voltage	13.8V DC \pm 15%
Squelch	Carrier/CTCSS/DCS/5Tone/2Tone/DTMF
Frequency Stability	\pm 1.5ppm
Operating Temperature	-20°C~+60°C
Dimensions(WxHxD)	160 (W) x 43 (H) x 185 (L)mm
Weight	about 1.29Kg

 Specifications are subject to change without notice due to advancements in NOTE technology.

Receiver

	Wide band	Narrow band
Sensitivity (12dB Sinad)	\leq 0.25 μ V	\leq 0.35 μ V
Adjacent Channel Selectivity	\geq 70dB	\geq 60dB
Intermodulation	\geq 65dB	\geq 60dB
Spurious Rejection	\geq 70dB	\geq 60dB
Audio Response	+1~-3dB(0.3~3KHz)	+1~-3dB(0.3~2.55KHz)
Hum & Noise	\geq 45dB	\geq 40dB
Audio distortion	\leq 5%	
Audio power output	> 2W@10%	

Transmitter

	Wide band	Narrow band
Power Output	90W/30W/10W/5W	
Modulation	16K Φ F3E	11K Φ F3E
Adjacent Channel Power	\geq 70dB	\geq 60dB
Hum & Noise	\geq 40dB	\geq 36dB
Spurious Emission	-36dBm	
Audio Response	+1~-3dB(0.3~3KHz)	+1~-3dB(0.3~2.55KHz)
Audio Distortion	\leq 5%	

36

General

Frequency Range (DR-B185TMKII)	RX: 136MHz~174MHz TX: 144MHz~148MHz AM: 108MHz~136MHz RX only FM: 76MHz~108MHz RX only
Frequency Range (DR-B185EMKII)	RX: 136MHz~174MHz TX: 144MHz~146MHz AM: 108MHz~136MHz RX only FM: 76MHz~108MHz RX only
Number of Channels	200 channels
Channel Spacing	25KHz (Wide Band) 20KHz (Middle Band) 12.5KHz (Narrow band)
Channel step	2.5KHz, 5KHz, 6.25KHz, 8.33KHz, 10KHz, 12.5KHz, 15KHz, 20KHz, 25KHz, 30KHz, 50KHz
Operating Voltage	13.8V DC $\pm 15\%$
Squelch	Carrier/CTCSS/DCS/5Tone/2Tone/DTMF
Frequency Stability	± 2.5 ppm
Operating Temperature	-20°C~+60°C
Dimensions(WxHxD)	160 (W) x 43 (H) x 185 (L)mm
Weight	about 1.28Kg

 Specifications are subject to change without notice due to advancements in NOTE technology.

Receiver

	Wide band	Narrow band
Sensitivity (12dB Sinad)	$\leq 0.25\mu\text{V}$	$\leq 0.35\mu\text{V}$
Adjacent Channel Selectivity	$\geq 70\text{dB}$	$\geq 60\text{dB}$
Intermodulation	$\geq 65\text{dB}$	$\geq 60\text{dB}$
Spurious Rejection	$\geq 70\text{dB}$	$\geq 60\text{dB}$
Audio Response	+1~-3dB(0.3~3KHz)	+1~-3dB(0.3~2.55KHz)
Hum & Noise	$\geq 45\text{dB}$	$\geq 40\text{dB}$
Audio distortion	$\leq 5\%$	
Audio power output	$> 2\text{W}@10\%$	

Transmitter

	Wide band	Narrow band
Power Output	90W/30W/10W/5W	
Modulation	16K Φ F3E	11K Φ F3E
Adjacent Channel Power	$\geq 70\text{dB}$	$\geq 60\text{dB}$
Hum & Noise	$\geq 40\text{dB}$	$\geq 36\text{dB}$
Spurious Emission	-36dBm	
Audio Response	+1~-3dB(0.3~3KHz)	+1~-3dB(0.3~2.55KHz)
Audio Distortion	$\leq 5\%$	

50 GROUPS CTCSS TONE FREQUENCY(HZ)

67.0	79.7	94.8	110.9	131.8	156.7	171.3	186.2	203.5	229.1
69.3	82.5	97.4	114.8	136.5	159.8	173.8	189.9	206.5	233.6
71.9	85.4	100.0	118.8	141.3	162.2	177.3	192.8	210.7	241.8
74.4	88.5	103.5	123.0	146.2	165.5	179.9	196.6	218.1	250.3
77.0	91.5	107.2	127.3	151.4	167.9	183.5	199.5	225.7	254.1

1024 GROUPS DCS CODE.

000	001	002	003	004	005	006	007
010	011	012	013	014	015	016	017
020	021	022	023	024	025	026	027
030	031	032	033	034	035	036	037
040	041	042	043	044	045	046	047
050	051	052	053	054	055	056	057
060	061	062	063	064	065	066	067
070	071	072	073	074	075	076	077
100	101	102	103	104	105	106	107
110	111	112	113	114	115	116	117
120	121	122	123	124	125	126	127
130	131	132	133	134	135	136	137
140	141	142	143	144	145	146	147
150	151	152	153	154	155	156	157
160	161	162	163	164	165	166	167
170	171	172	173	174	175	176	177
200	201	202	203	204	205	206	207
210	211	212	213	214	215	216	217
220	221	222	223	224	225	226	227
230	231	232	233	234	235	236	237
240	241	242	243	244	245	246	247
250	251	252	253	254	255	256	257
260	261	262	263	264	265	266	267
270	271	272	273	274	275	276	277
300	301	302	303	304	305	306	307
310	311	312	313	314	315	316	317

320	321	322	323	324	325	326	327
330	331	332	333	334	335	336	337
340	341	342	343	344	345	346	347
350	351	352	353	354	355	356	357
360	361	362	363	364	365	366	367
370	371	372	373	374	375	376	377
400	401	402	403	404	405	406	407
410	411	412	413	414	415	416	417
420	421	422	423	424	425	426	427
430	431	432	433	434	435	436	437
440	441	442	443	444	445	446	447
450	451	452	453	454	455	456	457
460	461	462	463	464	465	466	467
470	471	472	473	474	475	476	477
500	501	502	503	504	505	506	507
510	511	512	513	514	515	516	517
520	521	522	523	524	525	526	527
530	531	532	533	534	535	536	537
540	541	542	543	544	545	546	547
550	551	552	553	554	555	556	557
560	561	562	563	564	565	566	567
570	571	572	573	574	575	576	577
600	601	602	603	604	605	606	607
610	611	612	613	614	615	616	617
620	621	622	623	624	625	626	627
630	631	632	633	634	635	636	637
640	641	642	643	644	645	646	347
650	651	652	653	654	655	656	657
660	661	662	663	664	665	666	667
670	671	672	673	674	675	676	677

700	701	702	703	704	705	706	707
710	711	712	713	714	715	716	717
720	721	722	723	724	725	726	727
730	731	732	733	734	735	736	737
740	741	742	743	744	745	746	747
750	751	752	753	754	755	756	757
760	761	762	763	764	765	766	767
770	771	772	773	774	775	776	777



NOTE N is positive code, I is negative code, total: 1024groups.

[MEMO]

Manufacturer:

ALINCO, INC.

Yodoyabashi Dai-bldg 13F

4-4-9 Koraibashi, Chuo-ku, Osaka 541-0043 Japan

Phone: +81-6-7636-2362 Fax: +81-6-6208-3802

<http://www.alinco.com>

E-mail: export@alinco.co.jp



Electrical and electronic equipment and batteries should be recycled at a facility capable of handling these items. Contact your local authority for details of disposal rules.

Copyright Alinco, Inc. PS1185 / FNFI-EF

Printed in China