

FTM-150R/E

Firmware Upgrade Manual

Important

This firmware is provided for the FTM-150R/E.

Before downloading the software, please read the "Important Notes" carefully.

Downloading this firmware will indicate your agreement with the contents of the "Important Notes".

"Transceiver" is used hereafter to refer to the FTM-150R/E transceiver.

CAUTION

Please be sure to confirm the model and the destination (Type) of your transceiver before writing firmware to it. Writing incorrect firmware to the transceiver may cause abnormal operation or failure.

Important Notes

- All responsibility in using this firmware lies with the customer. We cannot be held responsible in any way for damages or losses which may be incurred by the customer as a result of using this firmware.
- Copyrights and all other intellectual property rights for the firmware, as well as the manual, are the property of YAESU MUSEN CO., LTD.
- The revision and modification of this firmware is prohibited. Redistribution, transfer, and resale of downloaded files are also prohibited.
- Downloaded files are for personal use only.
- If assistance is needed to perform the firmware upgrade, please consult with one of our sales sites or service centers.

The transceiver settings must be reset immediately after updating the firmware. Resetting the transceiver will clear all memories and the setting data in the setting menu.

Before updating the firmware, it is recommended to back up the memory data saved in the memory channels and the setting data of the setting menu.

1. Press and hold the **[F(BACK)]** key.
2. Rotate the Right **DIAL** knob to select **[47 BACKUP]**, then press the Right **DIAL** knob.
3. Make sure that **[WRITE TO SD]** is highlighted and press the Right **DIAL** knob.
4. Make sure that **[ALL]** is highlighted and press the Right **DIAL** knob.
Confirmation screen is displayed.
5. Rotate the Right **DIAL** knob to select **[OK]**, then press the Right **DIAL** knob.

Refer to "47 BACKUP" described in the Advance Manual for the backup process.

Regarding this Firmware

MAIN and SUB firmware are available for the FTM-150R/E transceiver. Check the firmware version, and perform firmware upgrades when needed.

How to Confirm the Firmware Version

Confirm which current firmware versions are installed on the radio. If the current firmware versions are the same as the update versions, there is no need to update.

1. Press and hold the **[F(BACK)]** key.
2. Rotate the Right **DIAL** knob to select **[60 SOFTWARE VERSION]**.
Rotate the Left **DIAL** knob to select menu items in fast forward.
3. Press the Right **DIAL** knob.
 - The version of each firmware will be displayed on the screen.

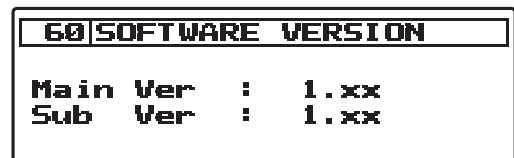
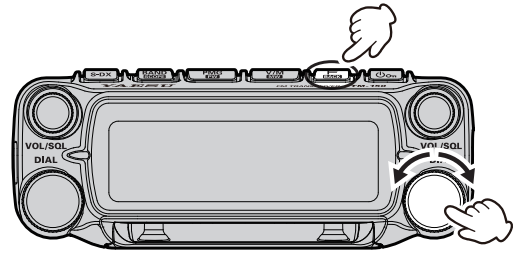

SD card preparation

Format (initialize) the SD card in advance with the FTM-150R/E transceiver, before updating the firmware. For information about SD cards that can be used, and the formatting procedure, refer to “Using a Micro SD Memory Card” described in the Operation Manual.

Formatting a Micro SD Memory Card

- A microSD memory card that was used in another device may not function properly, for example, it may not be recognized by the FTM-150R/E, or reading and writing may take an unusually long time. Use of the SD Memory Card Formatter provided by the SD Association may improve this. The **SD Memory Card Formatter** can be downloaded from this URL (<https://www.sdcard.org/downloads/formatter/>).
- Formatting a microSD memory card erases all data saved on it. Before formatting the card, be sure to check for data and save it before formatting.

Format a new microSD memory card following the steps below before use:

1. Press and hold the **[F(BACK)]** key.
2. Rotate the Right **DIAL** knob to select **[49 SD FORMAT]**.
Rotate the Left **DIAL** knob to select menu items in fast forward.
3. Press the Right **DIAL** knob.
Confirmation screen “FORMAT?” is displayed.
4. Rotate the Right **DIAL** knob to select **[OK]**, then press the Right **DIAL** knob.
Initialization starts and “Formatting...” appears.
5. When formatting is completed, “Completed” appears on the LCD.

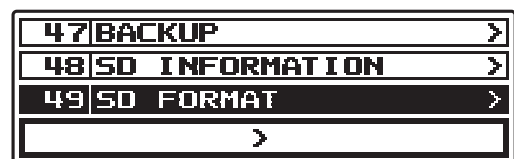
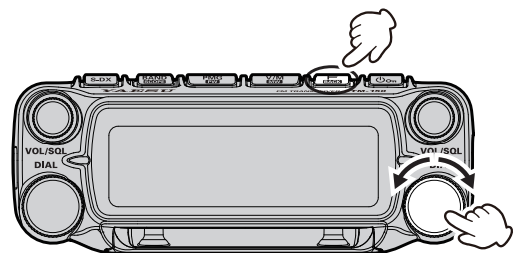

Downloading the Firmware

1. Download the “FTM-150_EXP_Firmware_Update_xxxxx.zip” compressed file from the YAESU website.
2. Unzip the downloaded file.
 - Using a PC with Windows OS, right click on the downloaded “zip” file. The “Extract All Contents Menu” will extract the contents of the zip file into a new folder, and then open the new folder.
 - The firmware file (extension is SFL) is in the “FTM-150_EXP_Firmware_Update_xxxxx” folder that is generated at the time of extraction.
 - Firmware File Name:
 - MAIN: **FTM-150_MAIN_EXP_Vxxxx.SFL**
 - SUB: **FTM-150_SUB_Vxxxx.SFL**
 - * “xxxx” refers to the version number.
3. Copy the firmware to an SD card that has been previously formatted in the FTM-150R/E.



Copy the file directly under the “FTM150” folder. Do not copy it into the any other folder. If the file is copied to a location other than under the “FTM150” folder, the FTM-150R/E cannot be updated, as it will not recognize the file.

- The folder configuration on the SD card formatted with FTM-150R/E is shown below.

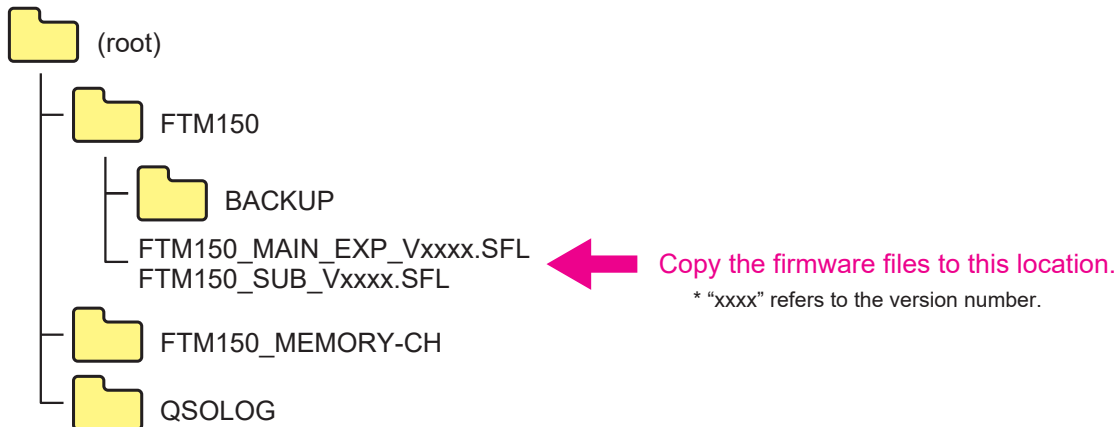

How to Update the Firmware

1. Turn the transceiver **OFF**.
2. Insert the micro SD card, written with the firmware, into the SD card slot.

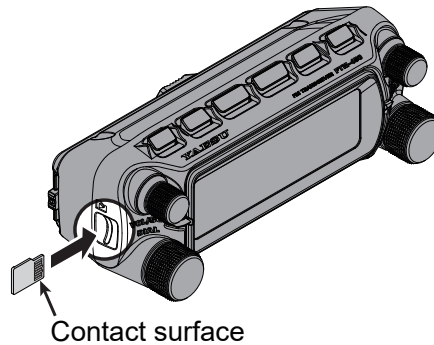

3. Press and hold the **[S-DX]** key and the **[POWER]** switch to turn the transceiver **ON**.
The "Firmware Update" screen will be displayed.

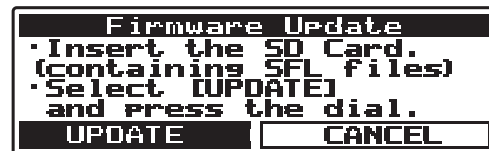
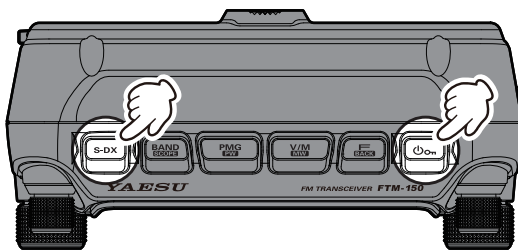

To cancel the update, rotate the Left **DIAL** knob to select **[CANCEL]**, then press the Left **DIAL** knob.

4. Press the Left **DIAL** knob.
The firmware versions in the FTM-150R/E and microSD memory card are displayed.

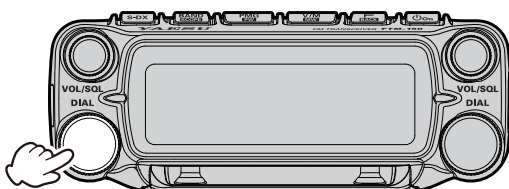

The same version as the firmware in the transceiver.
Indicates firmware to be updated.

A list of firmware in the transceiver.

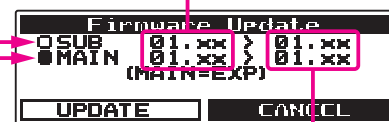

A list of firmware stored on the SD card.

- : Indicates firmware to be updated.
- : Firmware that the update is not necessary.



- If all files show ○ then the update is not necessary.
- Rotate the Left **DIAL** knob to select the firmware file, and then switch between ○ and ● by pressing the Left **DIAL** knob. Normally there is no need to change it, so just proceed to the next step.

5. Rotate the Left **DIAL** knob to select **[UPDATE]**, then press the Left **DIAL** knob.
Confirmation screen is displayed.
6. Press the Left **DIAL** knob to update the firmware.

Caution

Do not remove the SD card or turn the transceiver **OFF** while updating. If the update is interrupted the transceiver will not operate properly.

7. When the update is complete, "Completed" screen will be displayed.



- 8. Press the Left **DIAL** knob.
The transceiver will automatically turn OFF.
- 9. Reset the transceiver (see below).

Reset the transceiver

- 1. Turn the transceiver **ON**.
- 2. Press and hold the [**F(BACK)**] key.
The SETUP MENU screen will be displayed.

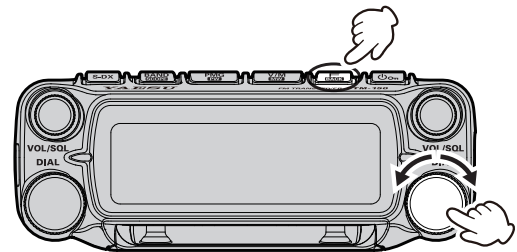

- 3. Rotate the Right **DIAL** knob to select [**62 FACTORY RE-SET**].
Rotate the Left **DIAL** knob to select menu items in fast forward.



- 4. Press the Right **DIAL** knob.
"FACTORY RESET" appears on the LCD.
- 5. Rotate the Right **DIAL** knob to select [**OK**].
- 6. Press the Right **DIAL** knob to reset all.



This completes the firmware upgrading process.

YAESU

Radio for Professionals

Copyright 2025
YAESU MUSEN CO., LTD.
All rights reserved.

No portion of this manual may be
reproduced without the permission of
YAESU MUSEN CO., LTD.

YAESU MUSEN CO., LTD.
Omori Bellport Building D-3F
6-26-3 Minami-Oi, Shinagawa-ku, Tokyo, 140-0013, Japan

YAESU USA
6125 Phyllis Drive, Cypress, CA 90630, U.S.A.

YAESU UK
Unit 4, Concorde Park, Concorde Way, Segensworth North,
Fareham, Hampshire PO15 5FG, United Kingdom